

F1763 Gain Flatness for Low IF frequencies

- June 5, 2014
- AT0104

Michael J. Virostko
Principal Product Application Engineer



The Analog and Digital Company™



Agenda

- Customer would like to use the F1763 mixer.
- The concern is the need to have gain flatness for IF frequencies from 20 to 120 MHz be less than 0.5 dB.
- F1763 is a single mixer with the RF and LO having single ended ports and the IF (output) being a differential port.
- Gain measurements will be made on our evaluation board.



Test Setup

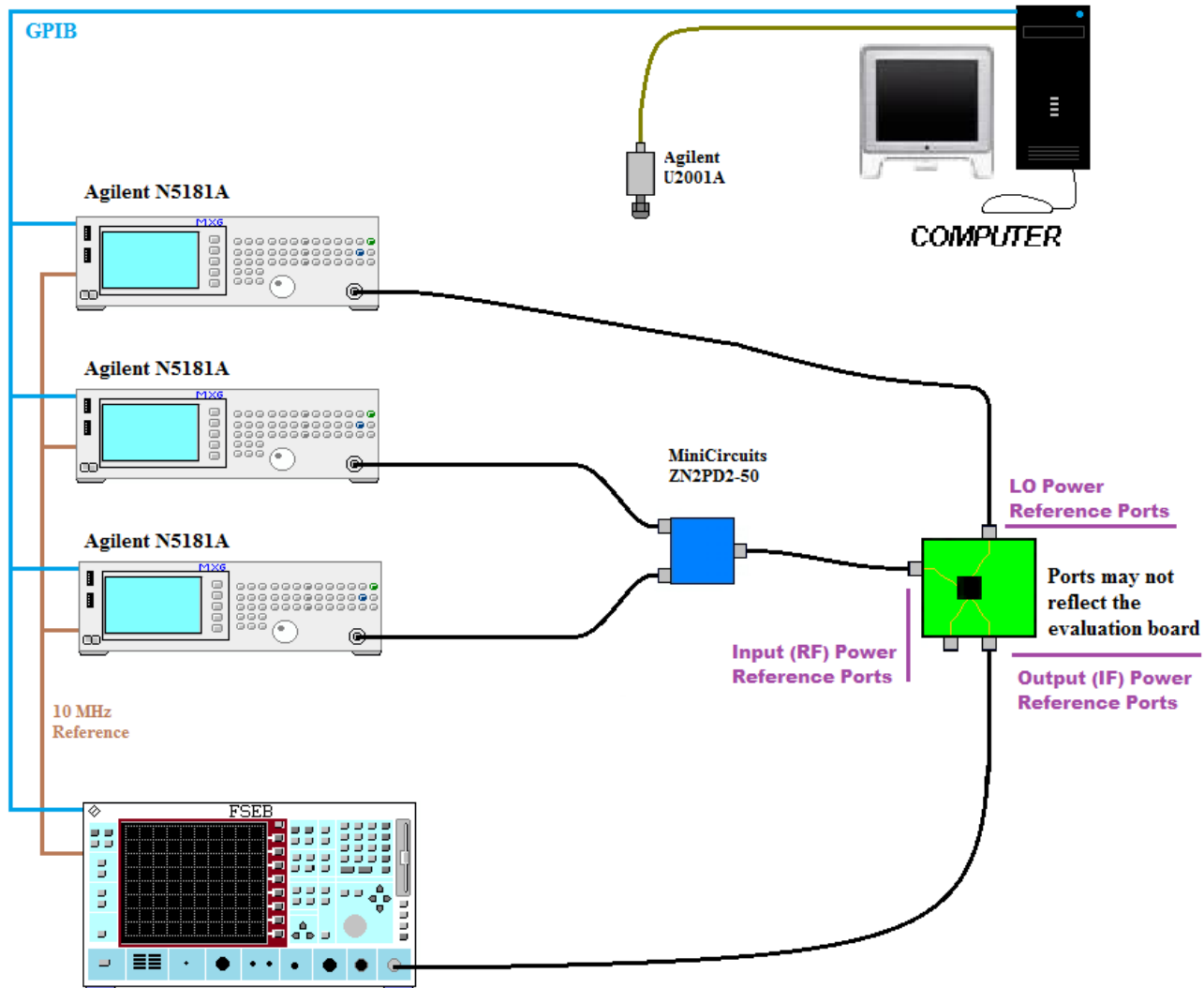

Measurements

- The conversion gain will be measured at the evaluation board connector with the following parameters
 - RF frequency swept from 1.9 to 3.0 GHz
 - RF power is set for -10 dBm
 - LO will be injected for both the low and high side.
 - LO power is set for 0 dBm
 - IF will be swept from 10 to 150 MHz
 - LO is derived from the RF and IF frequencies.
 - Room temperature only



Gain – High Side LO Injection

F1763 Gain
LO High Side Injection (IF = LO - RF), RF = -10 dBm, LO = 0dBm
at Evaluation board Connectors

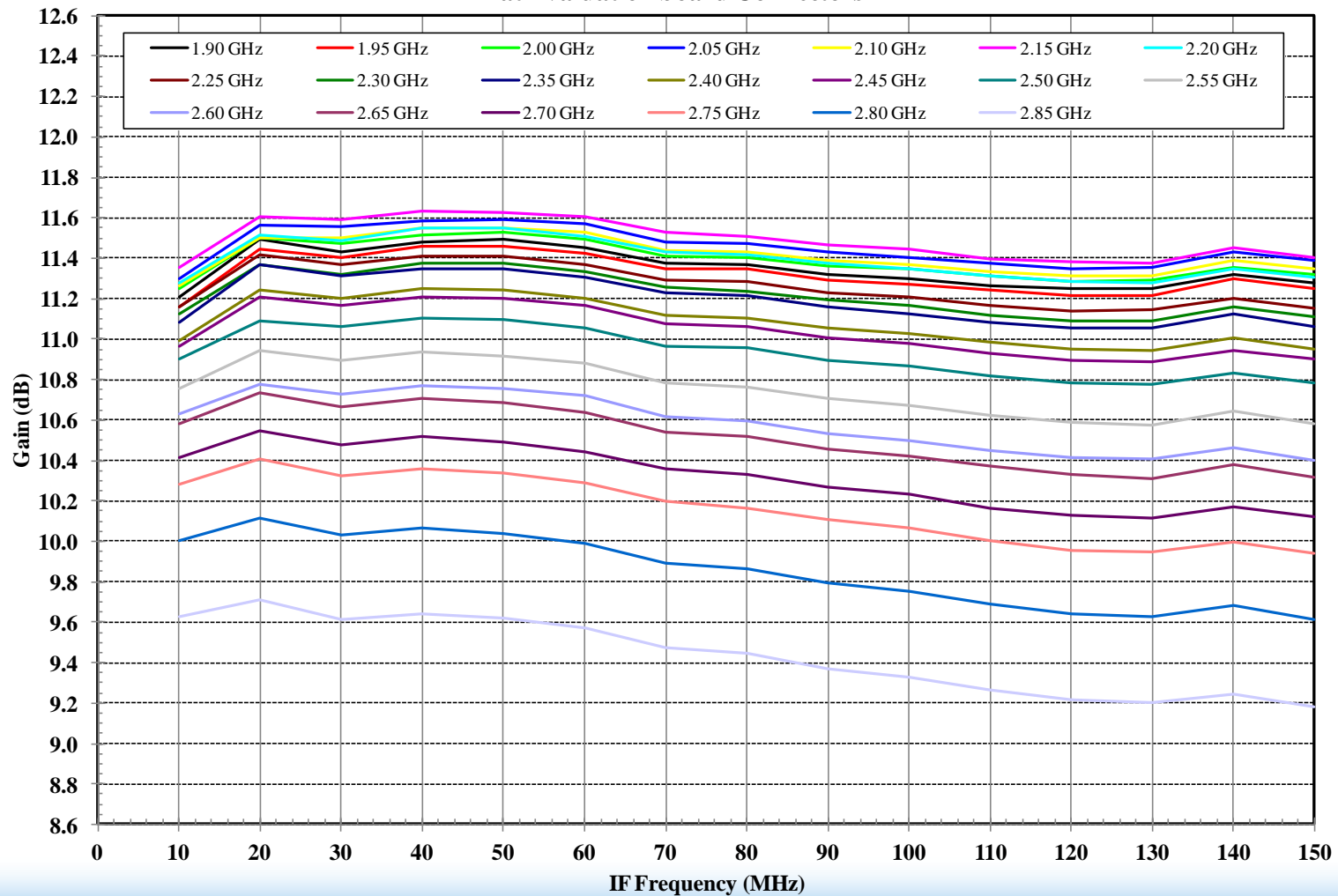

Gain – Low Side LO Injection

F1763 Gain
LO Low Side Injection (IF = RF - LO), RF = -10 dBm, LO = 0dBm
at Evaluation board Connectors

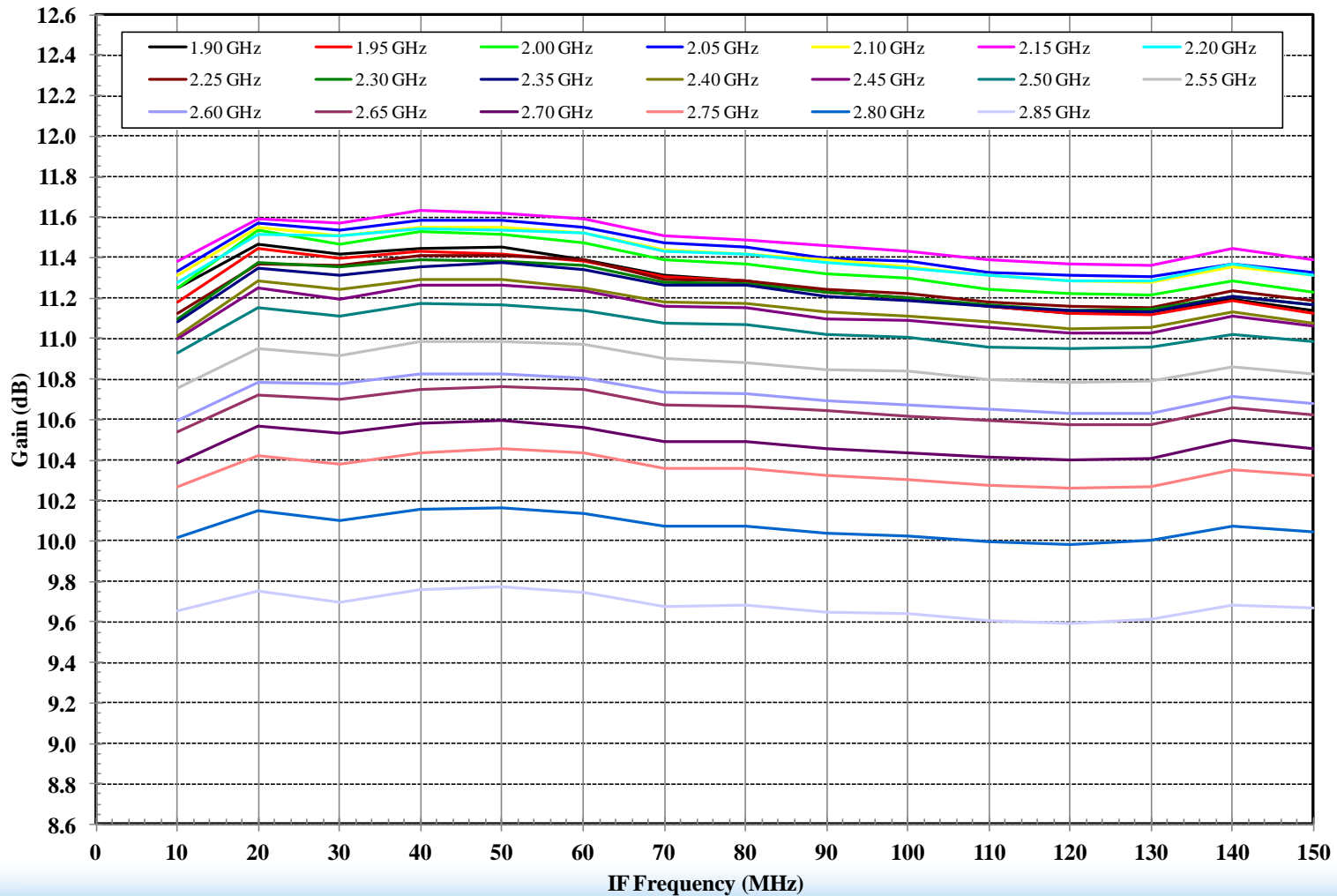

Gain Flatness – High Side LO Injection

F1763 Relative Gain (to Gain at 120 MHz)
LO High Side Injection (IF = LO - RF), RF = -10 dBm, LO = 0dBm
at Evaluation board Connectors

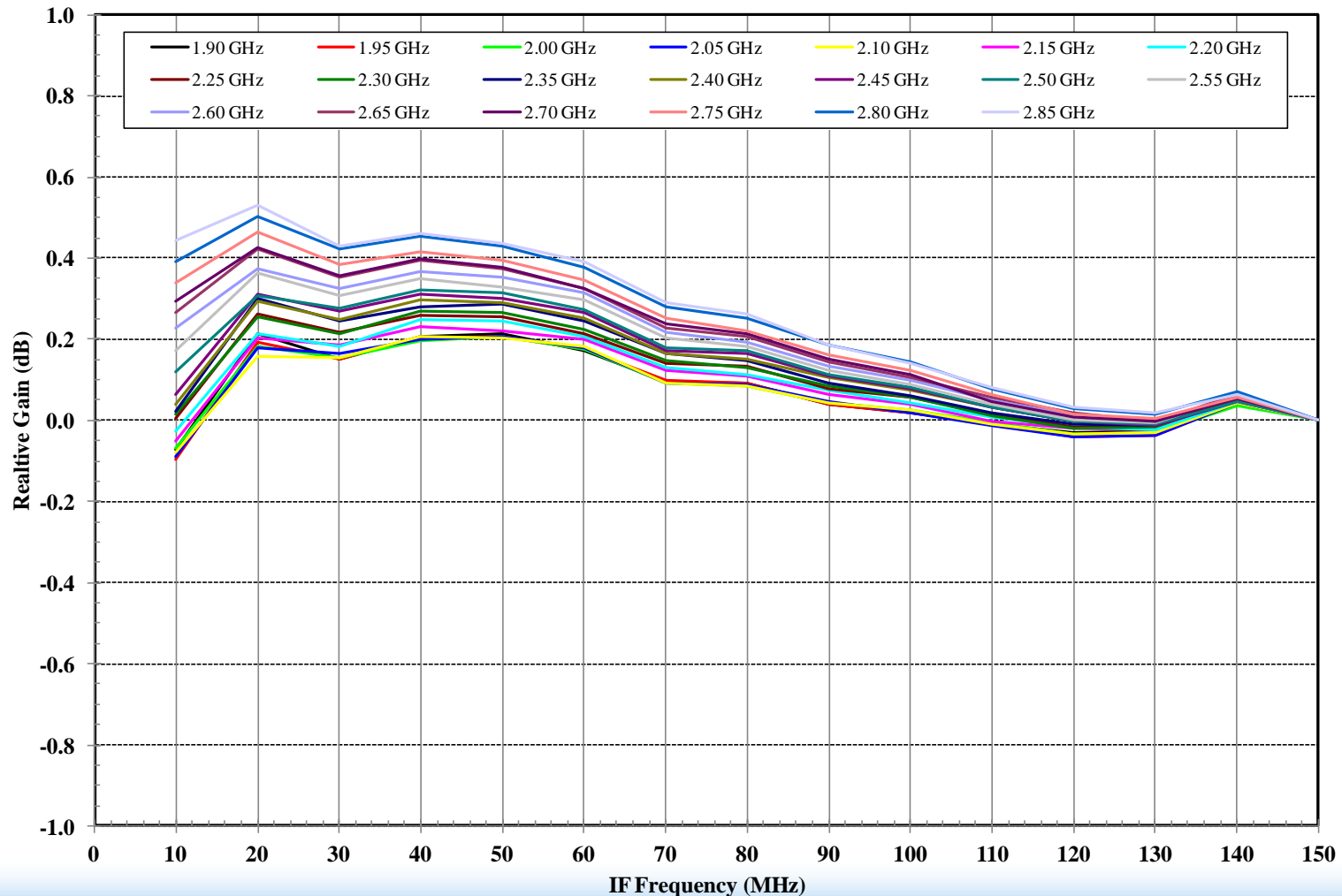

Gain Flatness – Low Side LO Injection

F1763 Relative Gain (to Gain at 120 MHz)
LO Low Side Injection (IF = RF - LO), RF = -10 dBm, LO = 0dBm
at Evaluation board Connectors

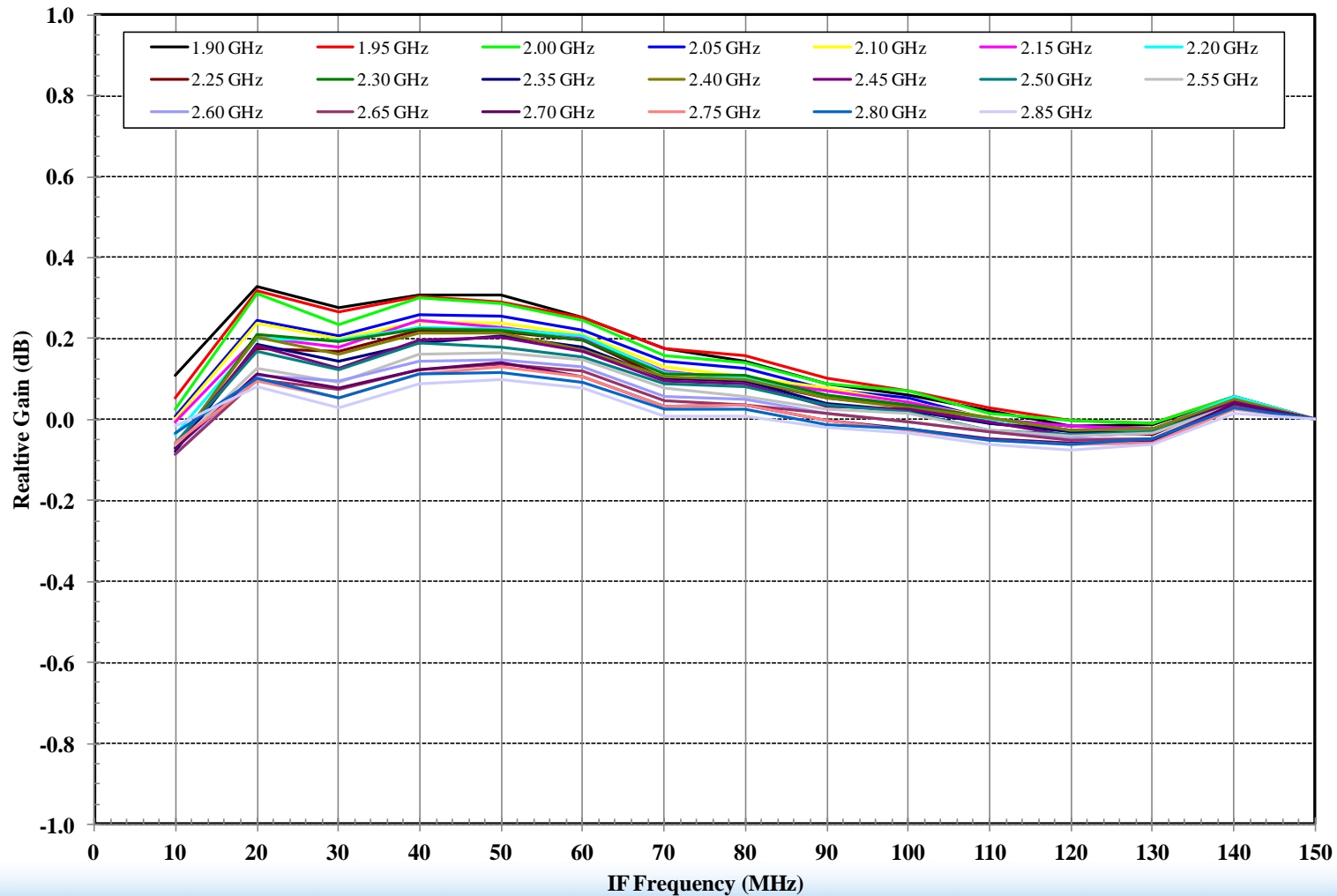

Evaluation Board for F1763 Mixer

- Evaluation Board is a multi-purpose board.
- IF Output Port has a characteristic impedance of 100 ohm single ended.
- Therefore a transformer is used to change the impedance which has it's own loss slope.
- Transformer is a MiniCircuit TG4-6TG2.

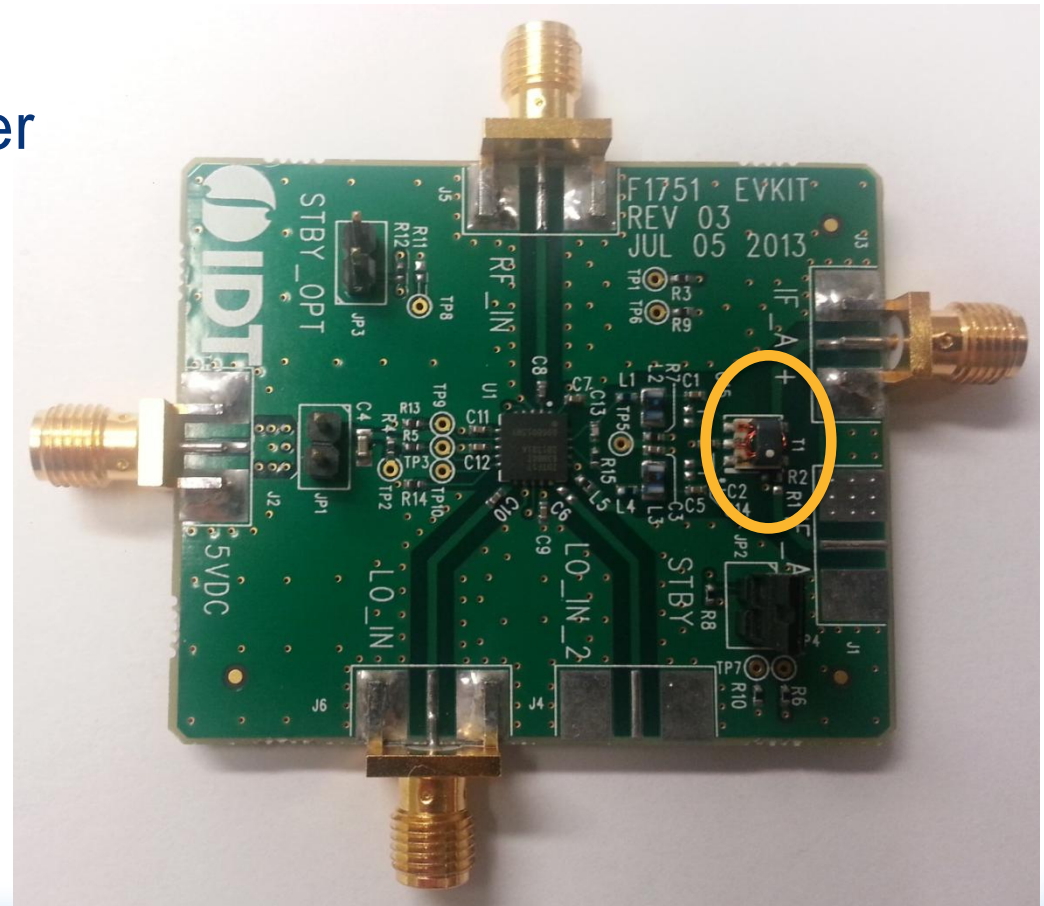

Gain Flatness

- For a given RF frequency the gain data shows that between 20 MHz and 120 MHz there is 0.5 dB of flatness. The rolloff is with increasing frequency. The plotted gain is to the evaluation board connectors.
- There are components that will affect the gain flatness.
 - Insertion loss to the Input (RF) pin. Since the data is plotted as a function of IF frequency this does not have any effect on the curve characteristics or gain flatness.
 - Insertion loss for the output (IF).
 - IF components
 - Board Loss
 - Transformer loss



Gain Flatness – IF Losses

- Board Loss
 - 0.03 to 0.08 dB for transmission line or 0.05 dB across the band
- IF components
 - Series Inductors (L1, L4) are 22 nH and could have a minor effect.
 - Shunt Inductors (L2, L3) are 820 nH and will not effect the loss.
 - Series capacitors (C1, C5) are 10 nF and will not effect the loss.
- Transformer loss
 - Biggest contributor



MiniCircuit TG4-6TG2

- Transformer characteristics are:
 - 1.5 to 600 MHz
 - 4:1 Ratio
 - Max Insertion Loss = 3 dB
 - Insertion loss shows a 0.2 dB variation over frequency with the same slope
 - This can be removed.

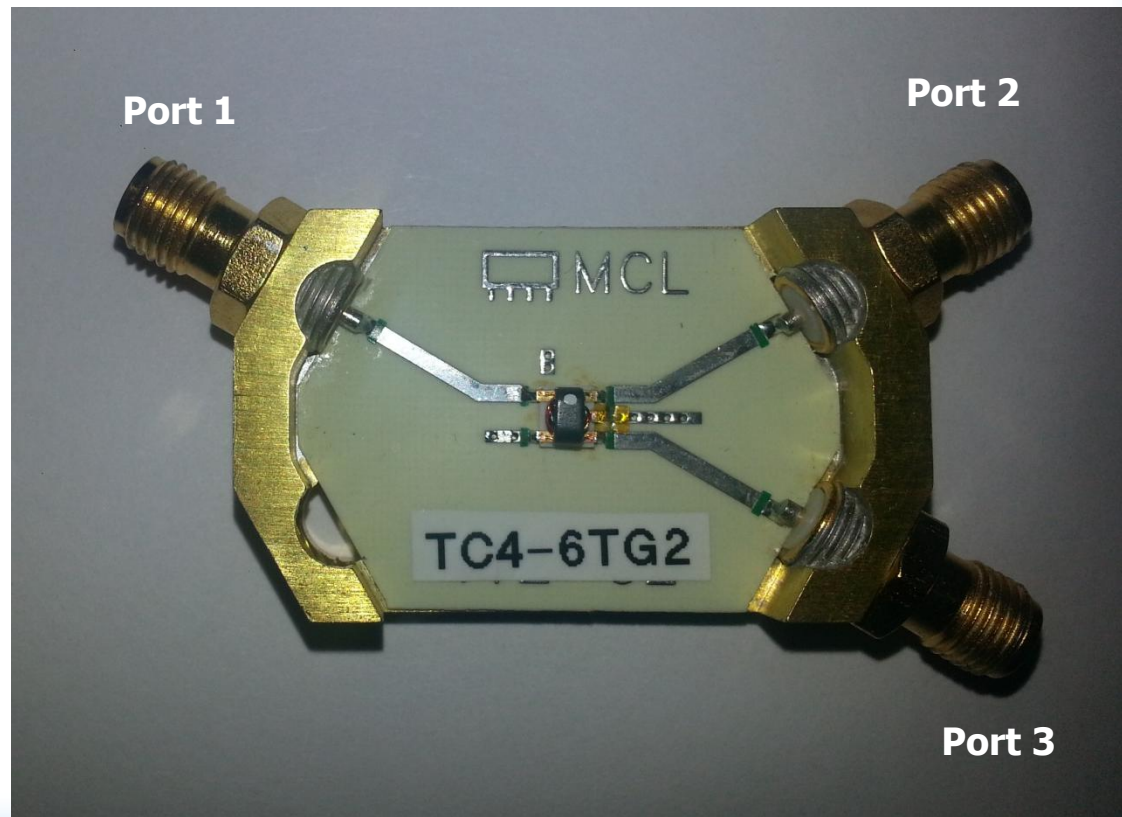

Insertion Loss for TC4-FTG2

MiniCircuits TC4-GTG2
Insertion Loss: Balance Port (2-3) to Signal Ended Port (Port 1)

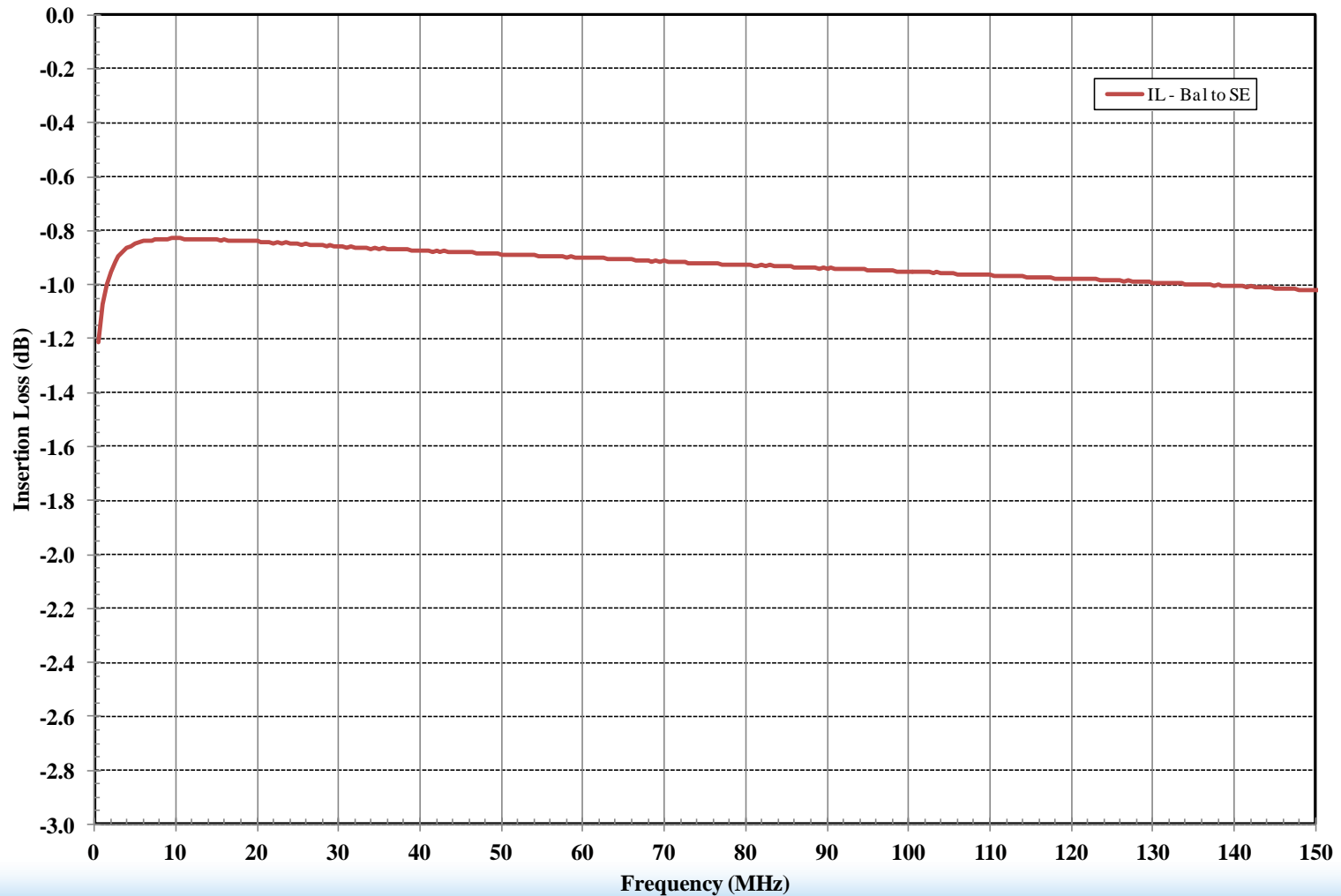

Gain – High Side LO, Removed Transformer

F1763 Gain
LO High Side Injection (IF = LO - RF), RF = -10 dBm, LO = 0dBm
at Evaluation board Connectors - Transform Insertion Loss Removed

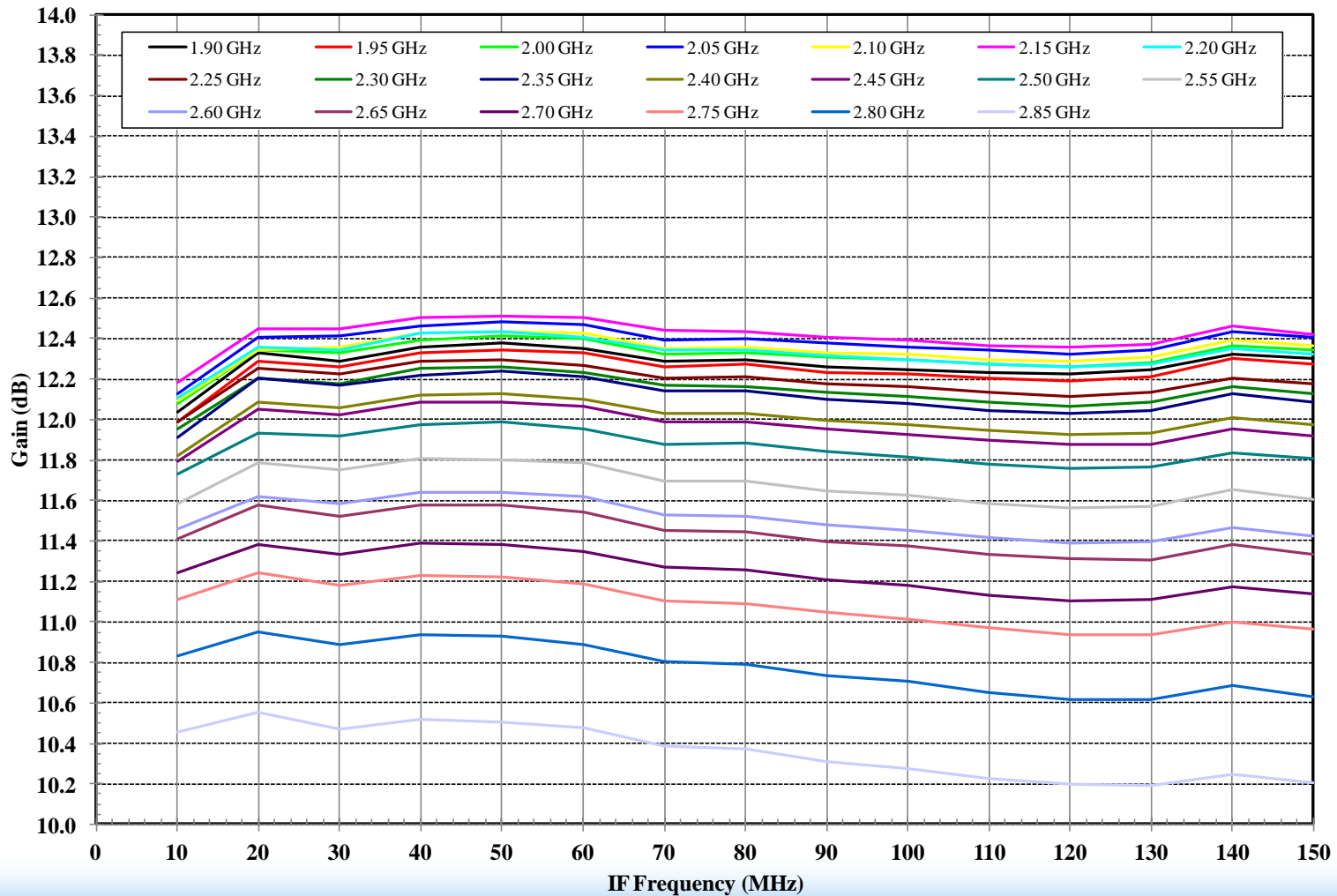

Gain – Low Side LO, Removed Transformer

F1763 Gain

LO Low Side Injection ($IF = RF - LO$), $RF = -10$ dBm, $LO = 0$ dBm
at Evaluation board Connectors - Transform Insertion Loss Removed

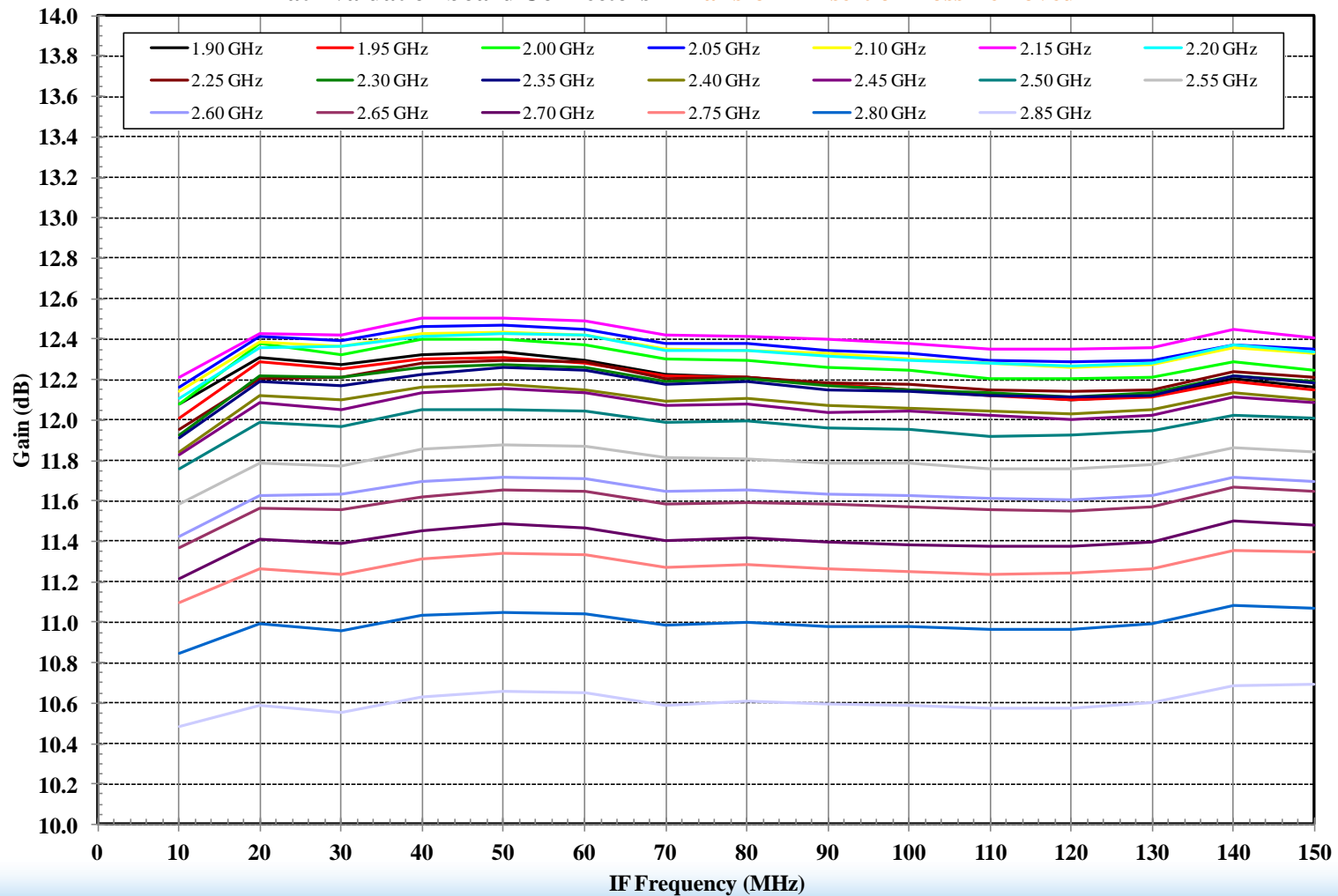

Gain Flatness – High Side LO, Removed Transformer

F1763 Relative Gain (to Gain at 120 MHz)

LO High Side Injection (IF = LO - RF), RF = -10 dBm, LO = 0dBm
at Evaluation board Connectors - Transform Insertion Loss Removed

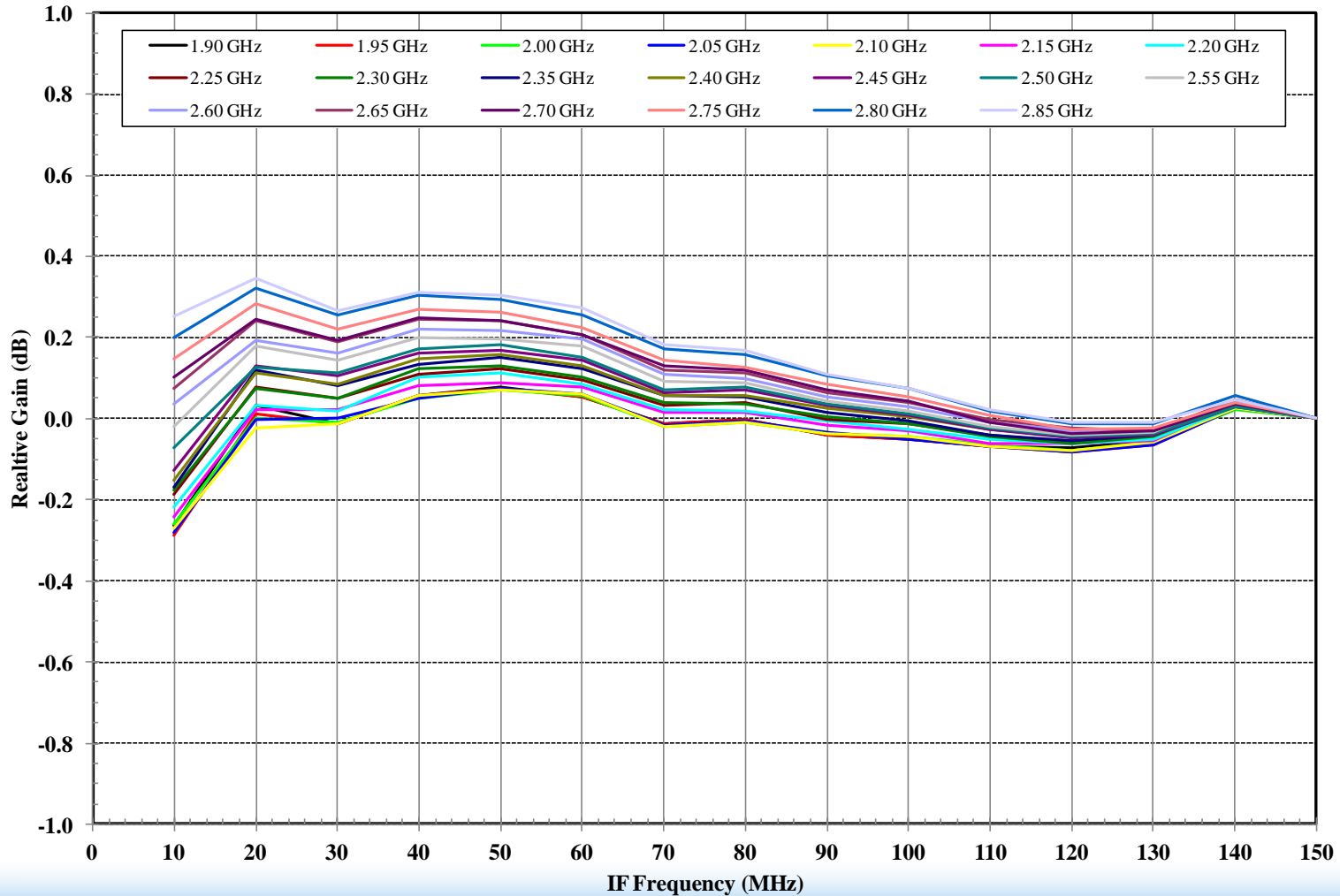

Gain Flatness – Low Side LO, Removed Transformer

F1763 Relative Gain (to Gain at 120 MHz)

LO Low Side Injection (IF = RF - LO), RF = -10 dBm, LO = 0dBm
at Evaluation board Connectors - Transform Insertion Loss Removed

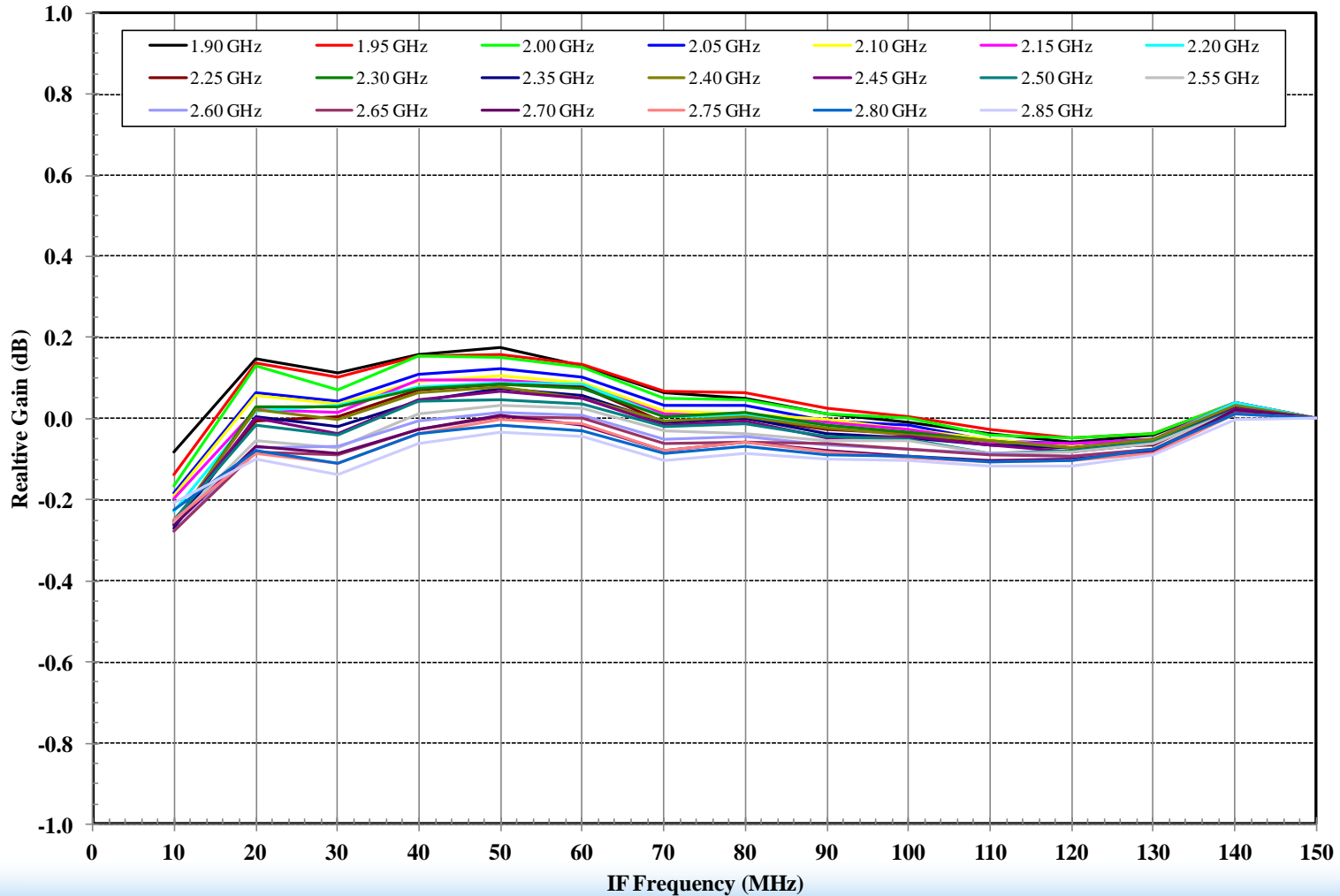

Conclusion

- Removing the transformer loss shows that we can reduce the gain flatness down to 0.4 dB.
- Add the board loss variation this is further reduced to 0.35 dB.
- ***Measured data show that the gain flatness can meet the customers requirements of less than 0.5 dB over the IF frequency band of 20 to 120 MHz.***

