

EMBOSS TAPE CONTAINER

Tape Dimensions

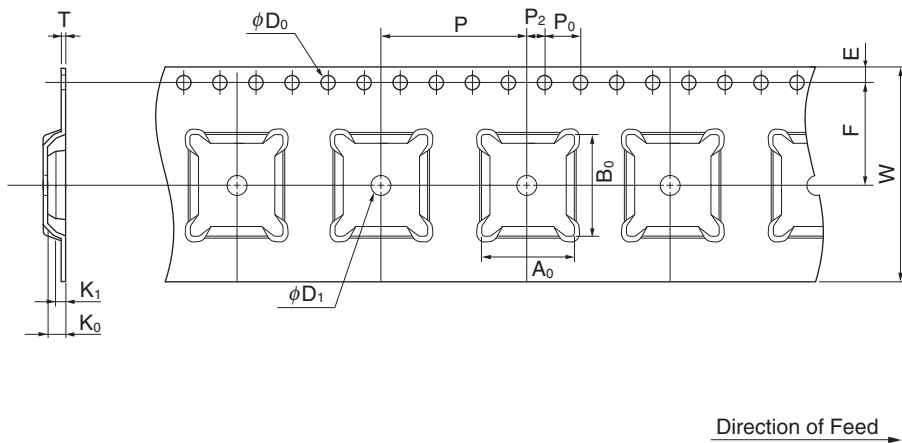

(Unit : mm)

Symbol	Specification
A_0	10.2
B_0	11.2
K_0	2.0
K_1	1.2
W	24.0 ± 0.3
F	11.5 ± 0.1
E	1.75 ± 0.1
P	16.0 ± 0.1
P_2	2.0 ± 0.1
P_0	4.0 ± 0.1
D_0	$1.5^{+0.1}_0$
T	0.3
D_1	1.5 MIN.

Reel Dimensions

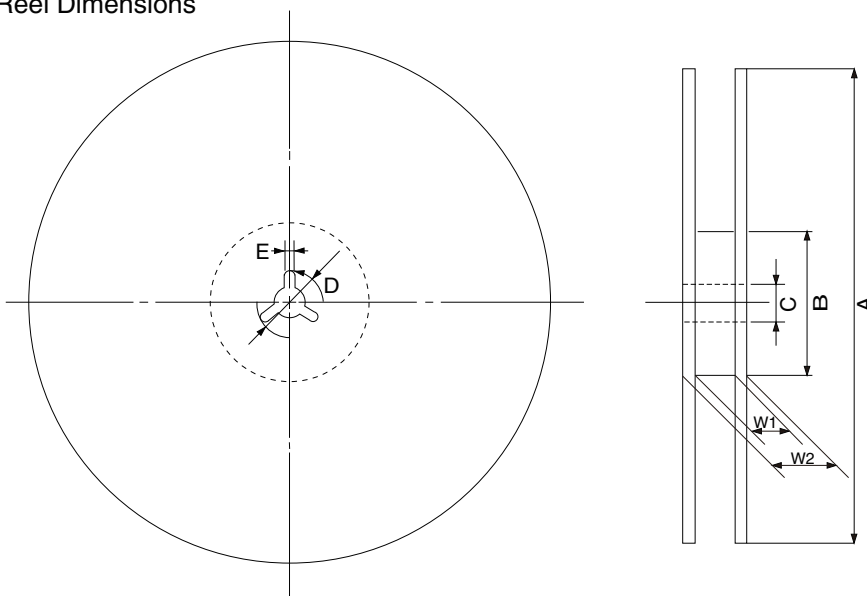

(Unit:mm)

Symbol	Specification
A	$\phi 330 \pm 2.0$
B	$\phi 100$
C	$\phi 13.0 \pm 0.2$
D	$\phi 21.0 \pm 0.8$
E	2.0 ± 0.5
W_1	25.5
W_2	29.5 ± 1.0

Applied Package	Quantity (pcs)
337-pin Plastic FBGA (11x10)	1,000 MAX.