

TRAY CONTAINER

UNIT : mm

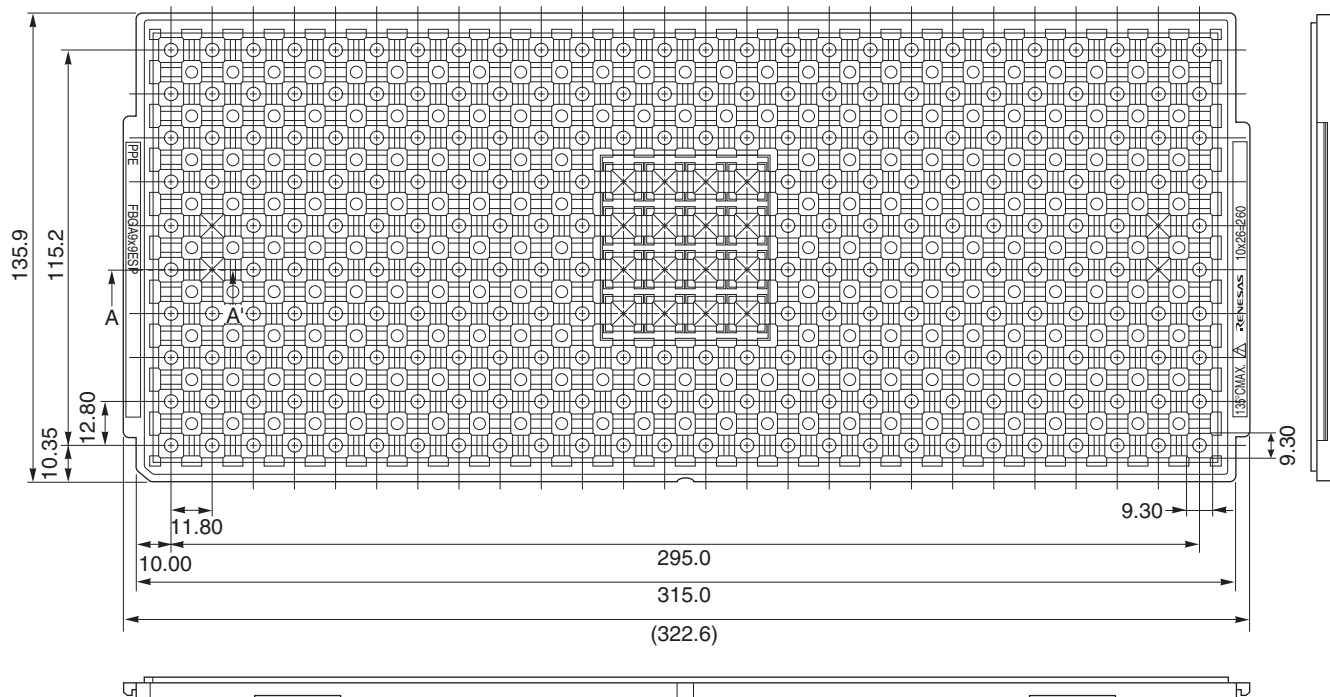

< SECTION A - A' >

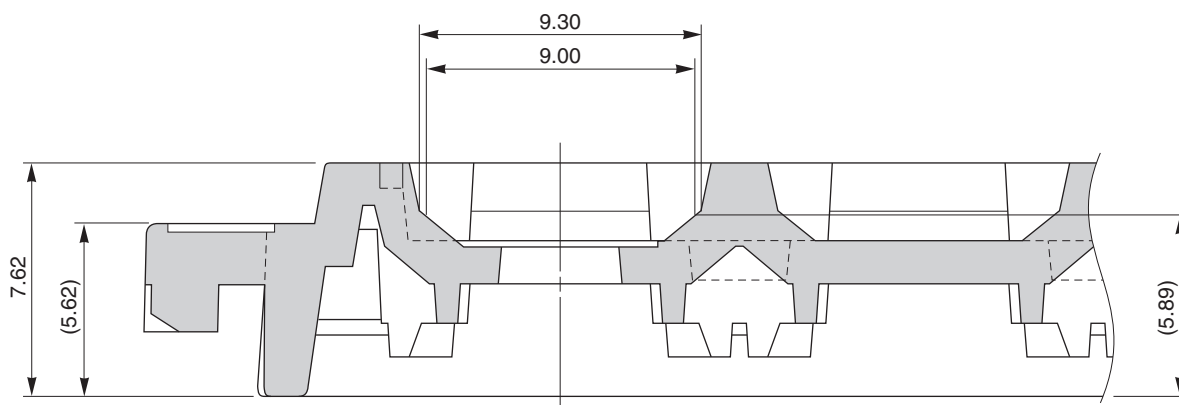

Applied Package	Quantity (pcs)
73-pin Plastic FBGA (9x9)	260 MAX.
80-pin Plastic FBGA (9x9)	
129-pin Plastic FBGA (9x9)	
141-pin Plastic FBGA (9x9)	
256-pin Plastic FBGA (9x9)	

Tray	FBGA 9x9 ESP
Material	Carbon PPE
Heat Proof Temp.	135°C MAX.
Surface resistance	less than $1 \times 10^{12} \Omega / \square$

The tolerance of tray's dimensions are based on JEDEC STANDARD.