

### GENERAL DESCRIPTION

This document describes the specifications for the IDTF1162 Zero-Distortion™ RF to IF Downconverting Mixer. This device is part of a series of mixers offered with high side or low side injection options for all UTRA bands. See the Part# Matrix for the details of all devices in this series.

The F1162 dual channel device is designed to operate with a single 5V supply. It is optimized for operation in a Multi-mode, Multi-carrier BaseStation Receiver for RF bands from 2300 - 2700 MHz with Low Side or High Side Injection. IF frequencies from 50 to 500 MHz are supported. Nominally, the device offers +43 dBm Output IP3 with 330 mA of I<sub>CC</sub>. Alternately one can adjust 4 resistor values and a toggle pin to run the device in low current mode with +38 dBm Output IP3 and 230 mA of I<sub>CC</sub>.

### COMPETITIVE ADVANTAGE

In typical basestation receivers the RF to IF mixer dominates the linearity performance for the entire receive system. The Zero-Distortion™ family of mixers dramatically improve the maximum signal levels (IM<sub>3</sub> tones) that the BTS can withstand at a desired Signal to Noise Ratio (SNR.) Alternately, one can run the device in Low Current Mode to reduce Power consumption significantly. Zero-Distortion™ technology allows realization of either benefit.

- ✓ IP3<sub>O</sub>: ↑ **11 dB** STD Mode, ↑ **5 dB** LC Mode
- ✓ Dissipation: ↓ **40%** LC, ↓ **15%** STD Mode
- ✓ Allows for higher RF gain improving **Sensitivity**



### PART# MATRIX

Part#	RF freq range	UTRA bands	IF freq range	Typ. Gain	Injection
F1100	698 - 915	5,6,8,12,13,14,17,19,20	50 - 450	8.5	High Side
F1102	698 - 915	5,6,8,12,13,14,17,19,20	50 - 250	8.5	Both
F1150	1700 - 2200	1,2,3,4,9,10, 33, 34,35, 36, 37,39	50 - 450	8.5	High Side
F1152	1400 - 2200	1,2,3,4,9,10,11 <sup>1</sup> , 21 <sup>1</sup> , 24 <sup>1</sup> , 33, 34,35, 36, 37,39	50 - 350	8.5	Low Side
<b>F1162</b>	<b>2300 - 2700</b>	<b>7,38,40,41</b>	<b>50 - 500</b>	<b>8.9</b>	<b>Both</b>

1 - with High side injection

### FEATURES

- Dual Path for Diversity Systems
- Ideal for Multi-Carrier Systems
- 8.9 dB Gain
- Ultra linear **+43 dBm IP3<sub>O</sub>**
- Low NF < 10 dB
- 200 Ω output impedance
- Ultra high +13 dBm P1dB<sub>I</sub>
- **Pin Compatible** w/existing solutions
- 6x6 36 pin package
- **Constant LO Port Z in STBY mode**
- < 200 nsec settling from Power Down
- Low Current Mode : **I<sub>CC</sub> = 230 mA**
- Standard Mode: I<sub>CC</sub> = 330 mA
- NOTE production BOM on p. 25

### DEVICE BLOCK DIAGRAM

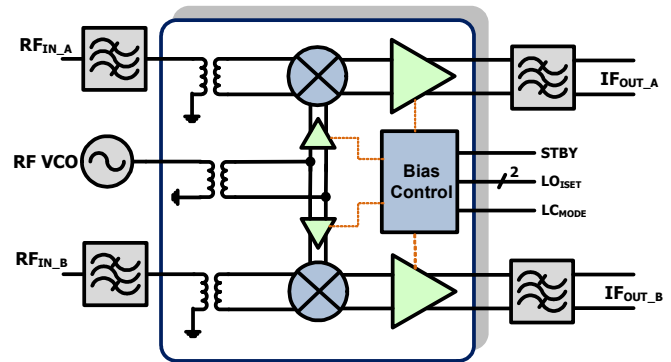

### ORDERING INFORMATION

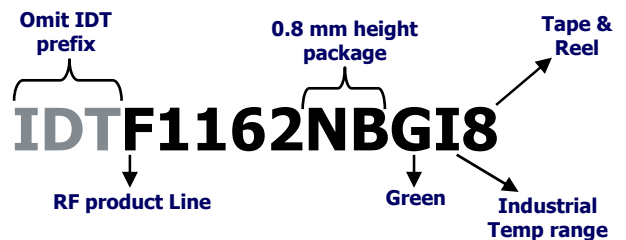

**ABSOLUTE MAXIMUM RATINGS**

VCC to GND	-0.3V to +5.5V
STBY, LC <sub>MODE</sub>	-0.3V to (VCC <sub>-</sub> + 0.3V)
IF_A+, IF_B+, IF_A-, IF_B-, LO1_ADJ, LO2_ADJ	-0.3V to (VCC <sub>-</sub> + 0.3V)
LO_IN, LO_IN_ALT, RF_A, RF_B	-0.3V to +0.3V
IF_BiasA, IF_BiasB to GND	-0.3V to +0.3V
RF Input Power (RF_IN[A+, A-, B+, B-])	+20dBm
Continuous Power Dissipation	2.2W
$\theta_{JA}$ (Junction – Ambient)	+35°C/W
$\theta_{JC}$ (Junction – Case) The Case is defined as the exposed paddle	+2.5°C/W
Operating Temperature Range (Case Temperature)	T <sub>C</sub> = -40°C to +100°C
Maximum Junction Temperature	150°C
Storage Temperature Range	-65°C to +150°C
Lead Temperature (soldering, 10s) .	+260°C

*Stresses above those listed above may cause permanent damage to the device. Functional operation of the device at these or any other conditions above those indicated in the operational section of this specification is not implied. Exposure to absolute maximum rating conditions for extended periods may affect device reliability.*

**RF to IF Dual Downconverting Mixer**
**2300 - 2700 MHz F1162NBGI**
**IDTF1162 SPECIFICATION**

Specifications apply at  $V_{CC} = +5.00V$ ,  $T_C = +25^{\circ}C$ ,  $F_{RF} = 2600\text{ MHz}$ ,  $F_{IF} = 400\text{ MHz}$ , Low Side Injection,  $P_{LO} = 0\text{ dBm}$ ,  $STBY = GND$ ,  $LC_{MODE} = V_{IH}$  (STD Mode), EVKit BOM = Standard Mode, Transformer Loss included (not de-embedded) unless otherwise noted.

Parameter	Comment	Symbol	min	typ	max	units
Logic Input High	For Standby, $LC_{MODE}$ Pins	$V_{IH}$	<b>2</b>			V
Logic Input Low	For Standby, $LC_{MODE}$ Pins	$V_{IL}$			<b>0.8</b>	V
Logic Current	For Standby Pin	$I_{IH}, I_{IL}$	<b>-30</b>		<b>+30</b>	$\mu A$
Logic Current	For $LC_{MODE}$ Pin	$I_{IH}, I_{IL}$	<b>-100</b>		<b>-20</b>	$\mu A$
Supply Voltage(s)	All $V_{CC}$ pins	$V_{CC}$		4.75 to 5.25		V
Operating Temperature Range	Case Temperature	$T_{CASE}$		-40 to +100		degC
Supply Current	Total $V_{CC}$ , STD Mode <ul style="list-style-type: none"> <li>▪ Total Both Channels</li> </ul>	$I_{STD}$		<b>330</b>	<b>375<sup>1</sup></b>	mA
Supply Current	Total $V_{CC}$ , LC Mode <ul style="list-style-type: none"> <li>▪ <math>LC_{MODE} = GND</math></li> <li>▪ EVkit BOM = LC Mode</li> <li>▪ Total Both Channels</li> </ul>	$I_{LC}$		<b>230</b>	<b>260</b>	mA
Supply Current	Standby Mode <ul style="list-style-type: none"> <li>▪ <math>STBY = V_{IH}</math></li> <li>▪ <math>LC_{MODE} &gt; V_{IH}</math> (STD Mode)</li> <li>▪ Total Both Channels</li> </ul>	$I_{STBY}$		<b>23</b>	<b>30</b>	mA
RF Freq Range	Operating Range	$F_{RF}$		2300 to 2700		MHz
IF Freq Range	Operating Range	$F_{IF}$		50 to 500		MHz
LO Freq Range	Operating Range	$F_{LO}$		1800 to 2900		MHz
LO Power	Operating Range	$P_{LO}$		-6 to +6		dBm
RF Input Impedance	Single Ended Return Loss ~20 dB	$Z_{RF}$		50		$\Omega$
IF Output Impedance	Differential Return Loss ~ 15 dB	$Z_{IF}$		200		$\Omega$
LO port Impedance	Single Ended Return Loss ~15 dB	$Z_{LO}$		50		$\Omega$
Settling Time	<ul style="list-style-type: none"> <li>• Pin = -13 dBm</li> <li>• Gate STBY from <math>V_{IH}</math> to <math>V_{IL}</math></li> <li>• Time for IF Signal to settle to within 0.1 dB of final value</li> </ul>	$T_{SETT}$		0.150		$\mu sec$
Gain STD Mode	Conversion Gain <ul style="list-style-type: none"> <li>• <math>F_{RF} = 2300\text{ MHz}</math></li> <li>• <math>LC_{MODE} = V_{IH}</math></li> <li>• EVkit BOM = STD Mode</li> <li>• <math>F_{IF} = 400\text{ MHz}</math> (Low Side Inj.)</li> </ul>	$G_{STD}$	<b>7.2</b>	<b>8.4</b>	<b>9.6</b>	dB

**IDTF1162 SPECIFICATION (CONTINUED)**

Parameter	Comment	Symbol	min	typ	max	units
Gain LC Mode	<b>Conversion Gain</b> <ul style="list-style-type: none"> <li>• <math>F_{RF} = 2700</math> MHz</li> <li>• <math>LC_{MODE} = GND</math></li> <li>• EVKit BOM = LC Mode</li> <li>• <math>F_{IF} = 200</math> MHz (High Side Inj.)</li> </ul>	$G_{LC}$	<b>6.8</b>	<b>7.9</b>	<b>9.0</b>	dB
NF STD Mode	<b>Noise Figure</b> <ul style="list-style-type: none"> <li>• RF trace de-embedded</li> <li>• <math>F_{IF} = 200</math> MHz</li> </ul>	$NF_{STD}$		9.9		dB
NF LC Mode	<b>Noise Figure</b> <ul style="list-style-type: none"> <li>• RF trace de-embedded</li> <li>• <math>LC_{MODE} = GND</math>, EVKit BOM = LC</li> <li>• <math>F_{IF} = 200</math> MHz</li> </ul>	$NF_{LC}$		9.7		dB
NF w/Blocker	<ul style="list-style-type: none"> <li>▪ +100 MHz offset blocker</li> <li>▪ <math>P_{BLOCKER} = +10</math> dBm</li> <li>▪ <math>F_{IF} = 250</math> MHz</li> </ul>	$NF_{BLK}$		23.5		dB
Output IP3 – STD mode	<ul style="list-style-type: none"> <li>▪ <math>P_{IN} = -10</math> dBm per tone</li> <li>▪ 800 KHz Tone Separation</li> </ul>	$IP3_{O1}$	$38^2$	43		dBm
Output IP3 – LC mode	<ul style="list-style-type: none"> <li>▪ <math>P_{IN} = -10</math> dBm per tone</li> <li>▪ <math>F_{IF} = 200</math> MHz (Low Side Inj.)</li> <li>▪ <math>F_{RF} = 2600</math> MHz</li> <li>▪ 800 KHz Tone Separation</li> <li>▪ <math>LC_{MODE} = GND</math></li> <li>▪ EVKit BOM = LC Mode</li> </ul>	$IP3_{O3}$	<b>33.5</b>	<b>37.7</b>		dBm
Output IP3 – High Side Injection	<ul style="list-style-type: none"> <li>▪ <math>P_{IN} = -10</math> dBm per tone</li> <li>▪ 800 KHz Tone Separation</li> <li>▪ <math>F_{IF} = 154</math> MHz (High Side Inj.)</li> <li>▪ <math>F_{RF} = 2600</math> MHz</li> <li>▪ Modified LC mode BOM (p. 26)</li> </ul>	$IP3_{O2}$		43		dBm
2RF – 2LO rejection	<ul style="list-style-type: none"> <li>▪ <math>P_{IN} = -10</math> dBm</li> <li>▪ Frequency = <math>F_{RF} - \frac{1}{2} F_{IF}</math></li> </ul>	2x2		-68		dBc
1 dB Compression – STD Mode	<ul style="list-style-type: none"> <li>▪ Input referred</li> <li>▪ 400 MHz IF</li> </ul>	$P1dB_{I1}$	11	11.9		dBm
1 dB Compression – LC Mode	<ul style="list-style-type: none"> <li>▪ <math>LC_{MODE} = GND</math></li> <li>▪ EVKit BOM = LC Mode</li> <li>▪ <math>F_{IF} = 200</math> MHz (Low Side Inj.)</li> </ul>	$P1dB_{I2}$	<b>8</b>	<b>10.2</b>		dBm
Gain Comp. w/blocker	<ul style="list-style-type: none"> <li>▪ Blocker → unmodulated tone</li> <li>▪ <math>P_{IN} = +8</math> dBm, +100 MHz offset</li> <li>▪ Signal Pin Tone = -20 dBm</li> <li>▪ Measure <math>\Delta G</math> of signal</li> <li>▪ <math>F_{IF} = 250</math> MHz</li> </ul>	$\Delta G_{AC}$		0.15		dB
Channel Isolation	IF_B Pout vs. IF_A w/ RF_A input	$ISO_C$		63		dB
LO to IF leakage	LO Frequency = 2200 MHz	$ISO_{LI}$		-32	-23	dBm
RF to IF leakage	$P_{in} = -10$ dBm	$ISO_{RI}$		-57	-43	dBm
LO to RF leakage	<ul style="list-style-type: none"> <li>• LO Frequency = 2345 MHz</li> <li>• Low Current Mode</li> </ul>	$ISO_{LR}$		-41		dBm

1 – Items in min/max columns in **bold italics** are Guaranteed by Test

2 – All other Items in min/max columns are Guaranteed by Design Characterization

**TYPICAL OPERATING CONDITIONS**

Unless otherwise Noted, the following Apply to the Typ Ops Graphs

- 800 KHz Tone Spacing
- Low Side injection graphs with 200MHz & 400MHz IF (pages 6 – 14)
- High Side injection graphs with 200MHz & 154MHz IF (pages 15 – 17)
- Average of Channel A & Channel B
- Pin = – 10 dBm per Tone
- LO port = Pin 19 (Main Port)
- Listed Temperatures are Case Temperature ( $T_C$  = Case Temperature)
- Where noted,  $T_A$  or  $T_{AMB}$  = Ambient Temperature

TYPICAL OPERATING CONDITIONS [IF = 200 MHz, Low Side Injection] (-1-)

Gain vs. T<sub>CASE</sub>

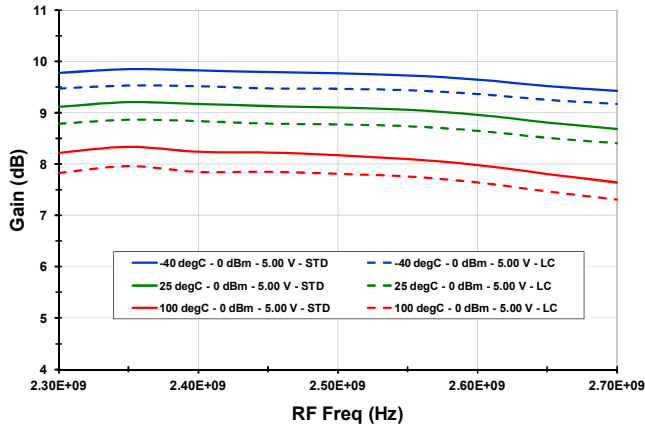

Gain vs. V<sub>CC</sub>

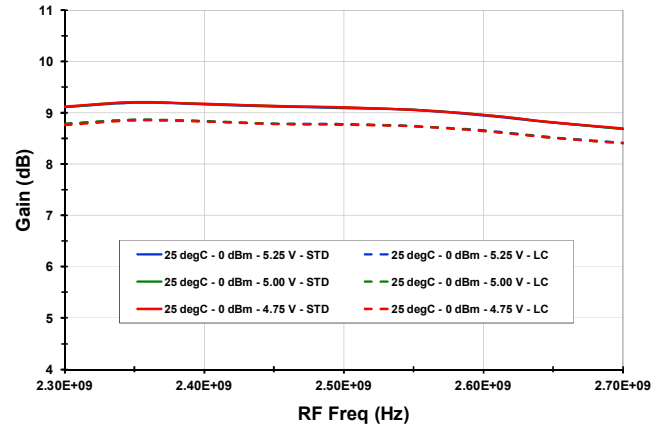

Gain vs. LO Level

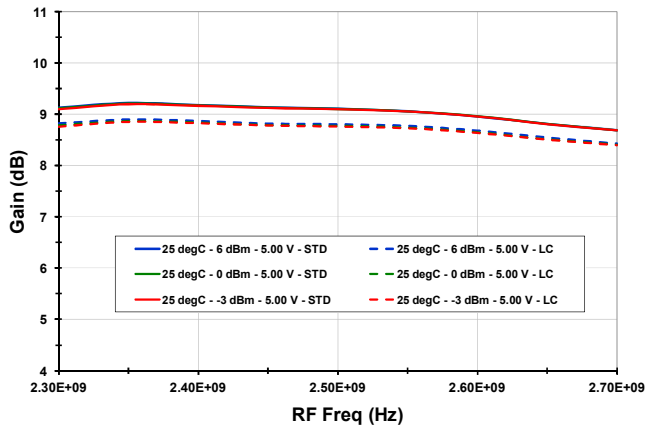

Output IP3 vs. T<sub>CASE</sub>

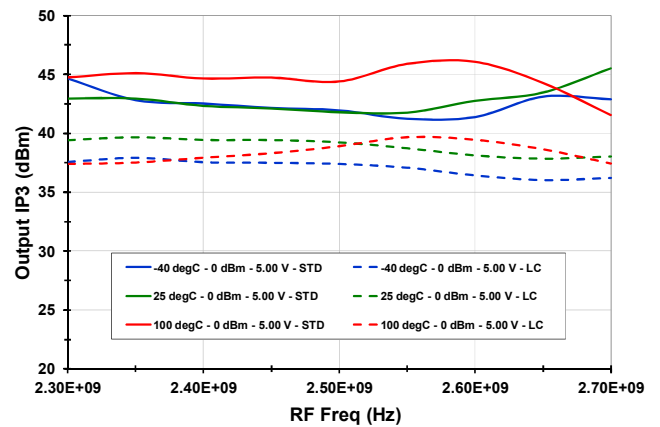

Output IP3 vs. V<sub>CC</sub>

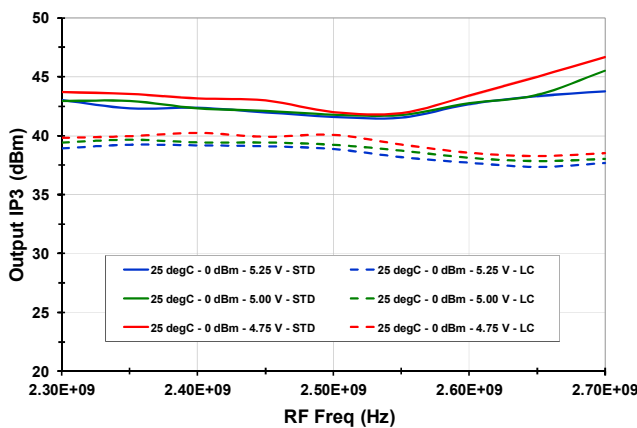

Output IP3 vs. LO Level

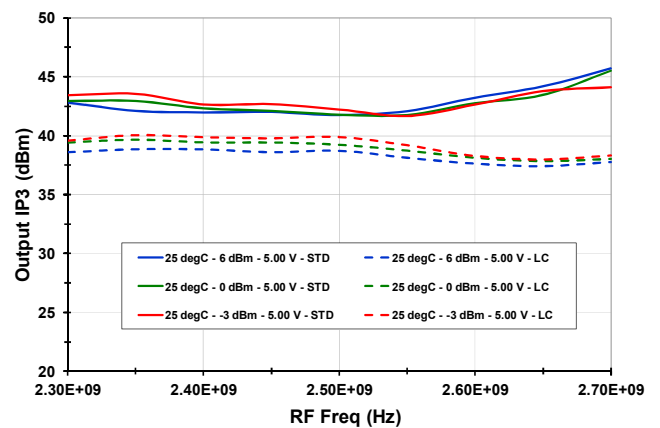

RF to IF Dual Downconverting Mixer

2300 - 2700 MHz F1162NBGI

TYPICAL OPERATING CONDITIONS [IF = 200 MHz, Low Side Injection] (-2-)

P1dB vs. T<sub>CASE</sub>

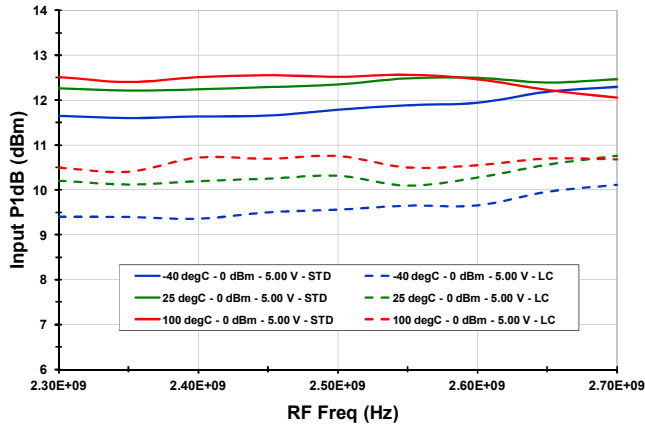

P1dB vs. V<sub>CC</sub>

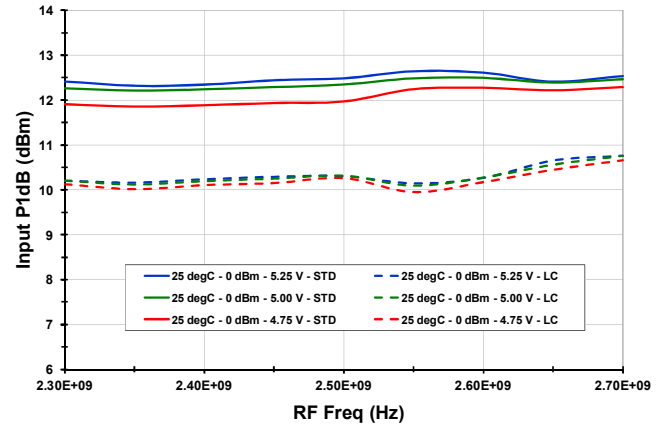

P1dB vs. LO Level

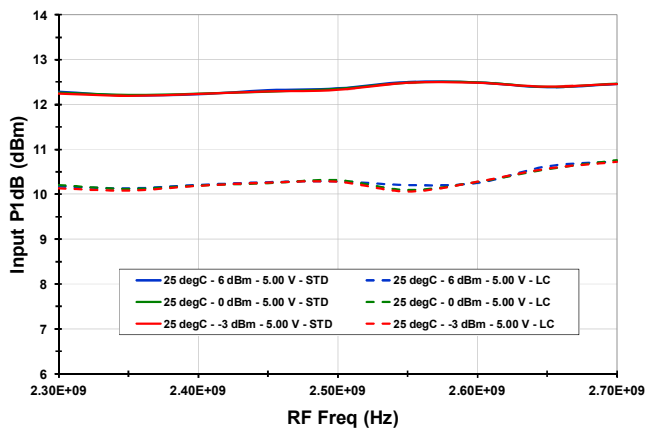

2RF x 2LO rejection vs. T<sub>CASE</sub>

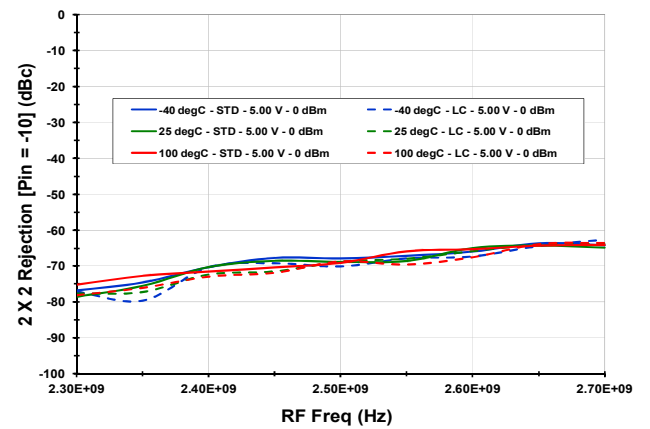

2RF x 2LO Rejection vs. V<sub>CC</sub>

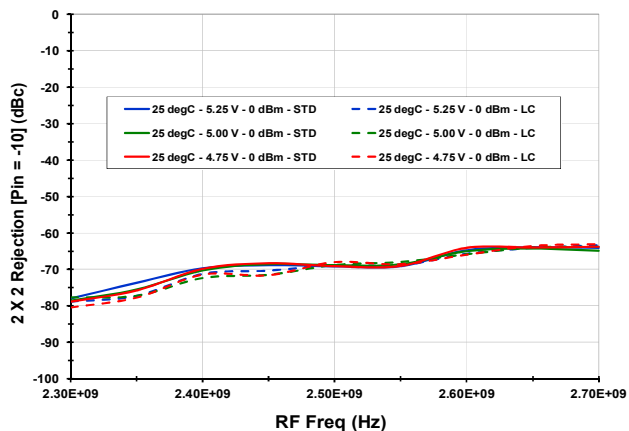

2RF x 2LO Rejection vs. LO Level

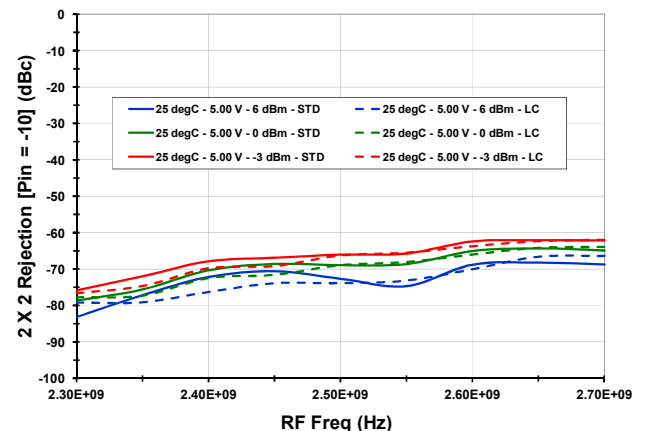

TYPICAL OPERATING CONDITIONS [IF = 200 MHz, Low Side Injection] (-3-)

I<sub>CC</sub> vs. T<sub>CASE</sub>

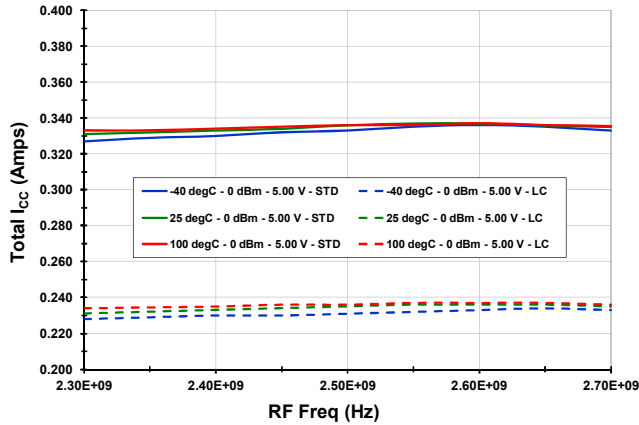

I<sub>CC</sub> vs. V<sub>CC</sub>

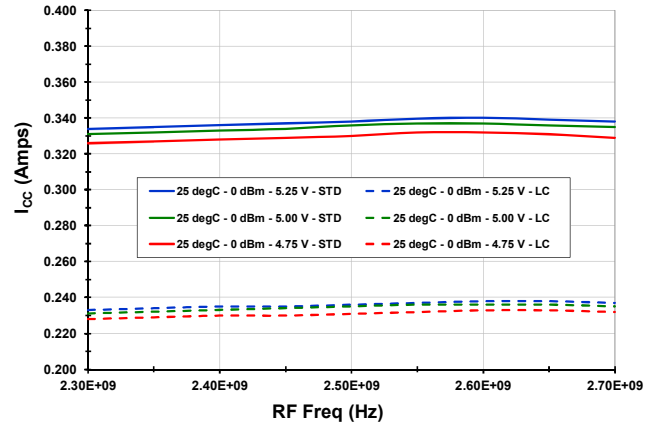

I<sub>CC</sub> vs. LO Level

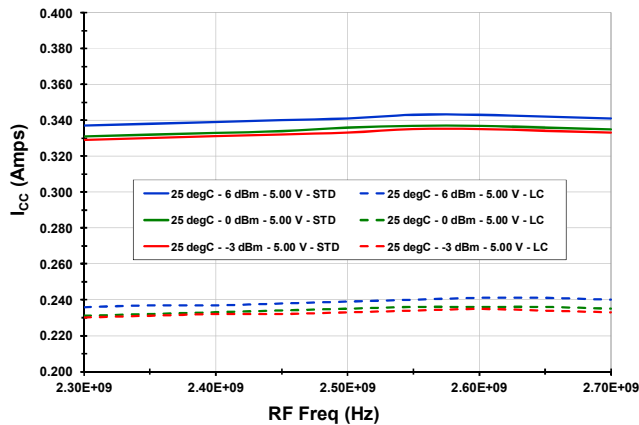

LO-IF Leakage vs. T<sub>CASE</sub>

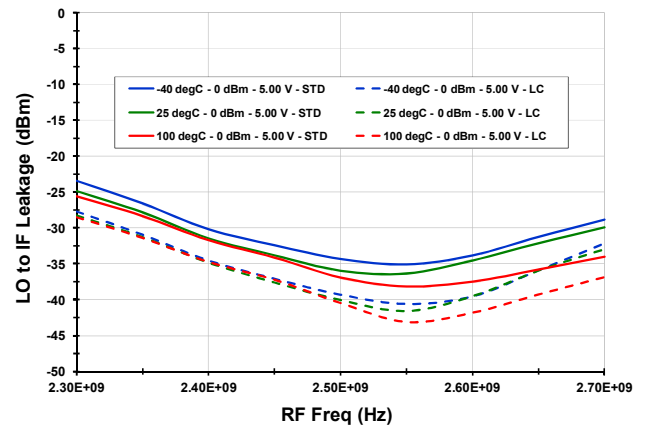

LO-IF Leakage vs. V<sub>CC</sub>

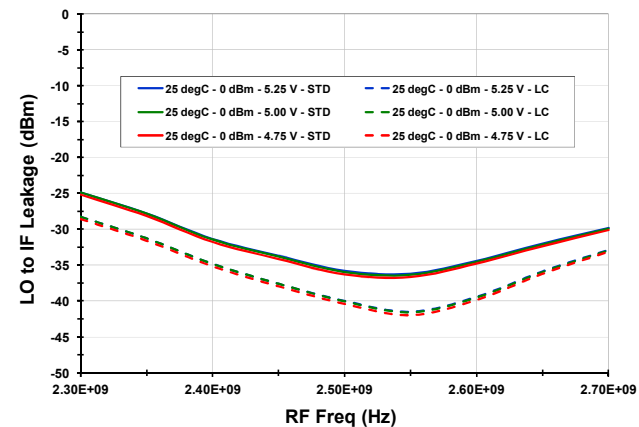

LO-IF Leakage vs. LO Level

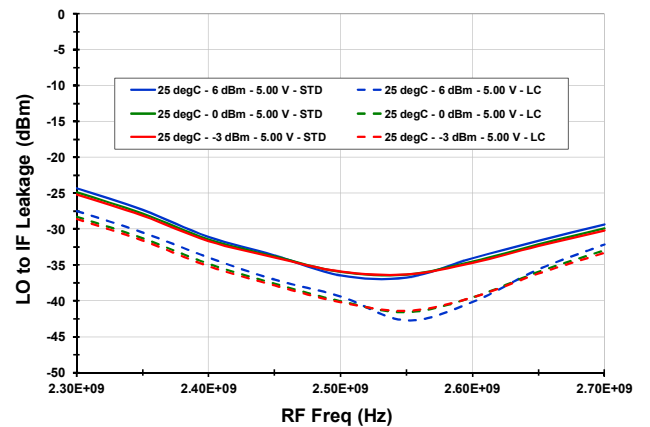



RF to IF Dual Downconverting Mixer

2300 - 2700 MHz F1162NBGI

TYPICAL OPERATING CONDITIONS [IF = 200 MHz, Low Side Injection] (-4-)

RF-IF Leakage vs. T<sub>CASE</sub>

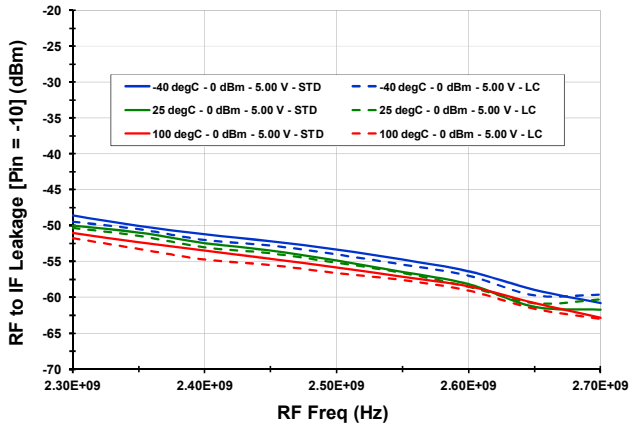

RF-IF Leakage vs. V<sub>CC</sub>

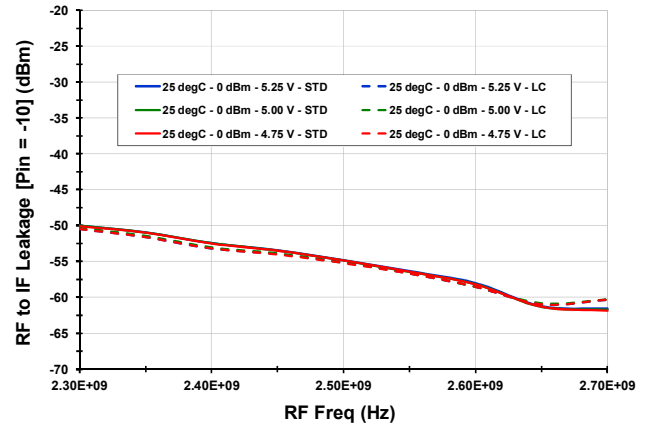

RF-IF Leakage vs. LO Level

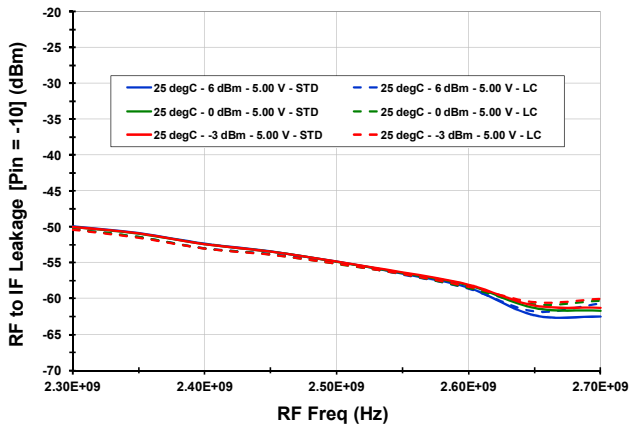

3RF X 3LO Rejection vs. T<sub>CASE</sub>

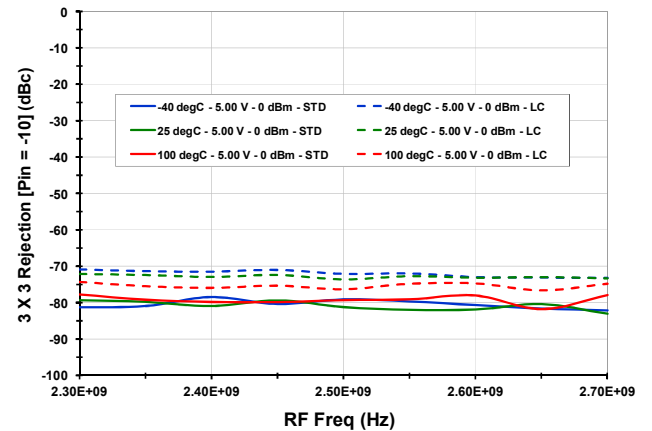

3RF X 3LO Rejection vs. V<sub>CC</sub>

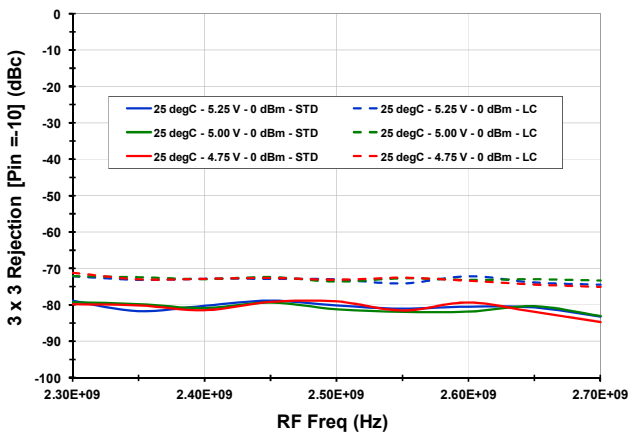

3RF X 3LO Rejection vs. LO Level

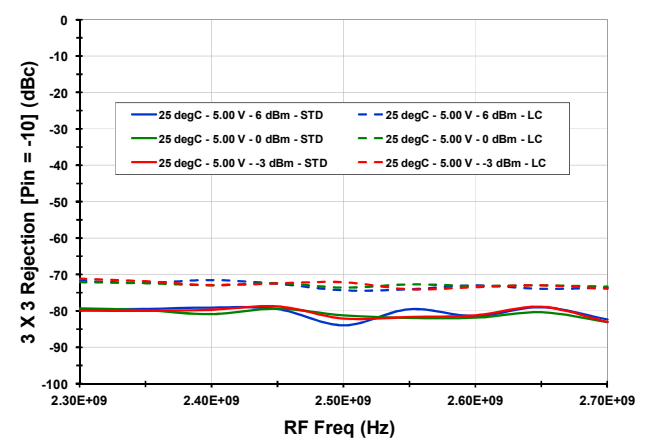

RF to IF Dual Downconverting Mixer

2300 - 2700 MHz F1162NBGI

TYPICAL OPERATING CONDITIONS [IF = 200 MHz, Low Side Injection] (-5-)

Channel Isolation vs. T<sub>CASE</sub>

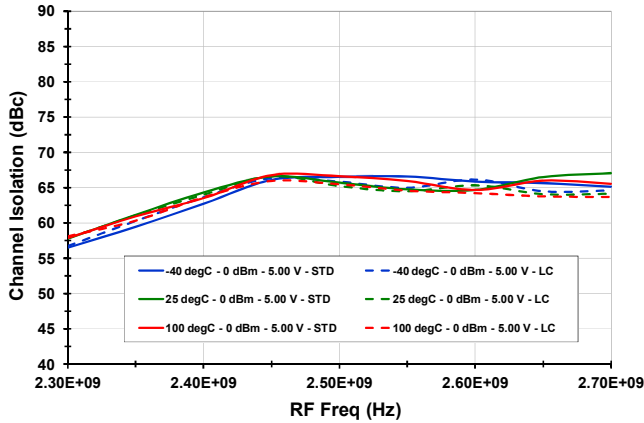

Channel Isolation vs. V<sub>CC</sub>

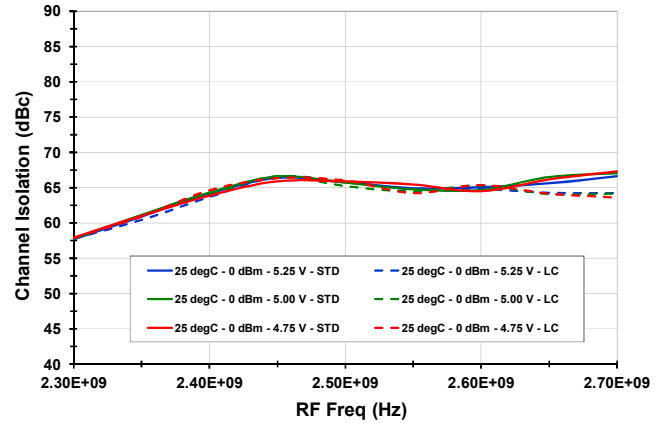

Channel Isolation vs. LO Level

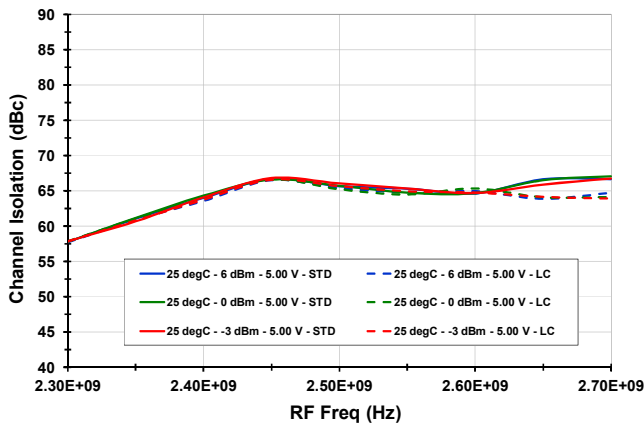

Noise Figure vs. T<sub>CASE</sub> (LC Mode)

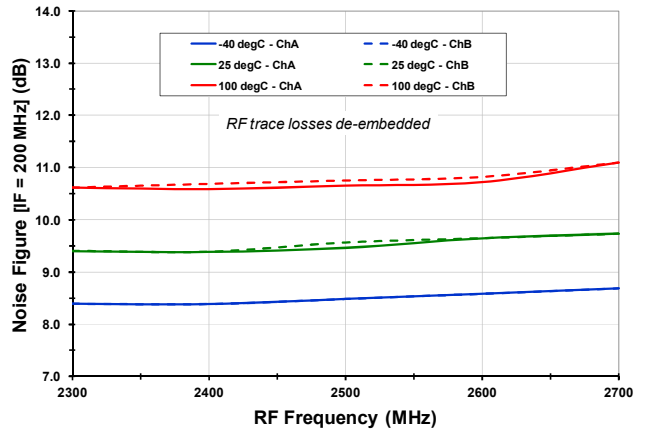

Noise Figure vs. T<sub>CASE</sub> (STD Mode)

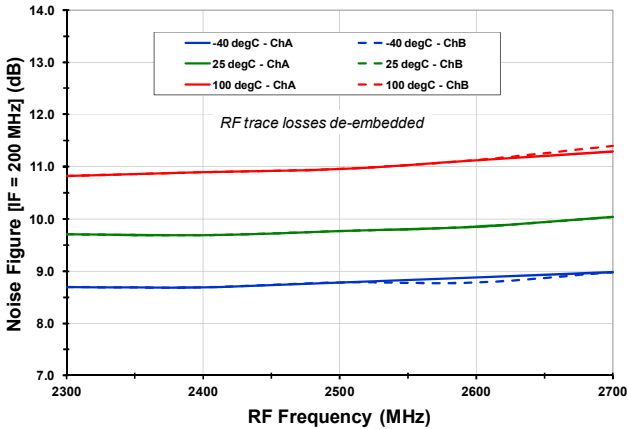

NF vs. Blocker (RF = 2600 MHz, IF = 250 MHz, T<sub>A</sub> = 25C)

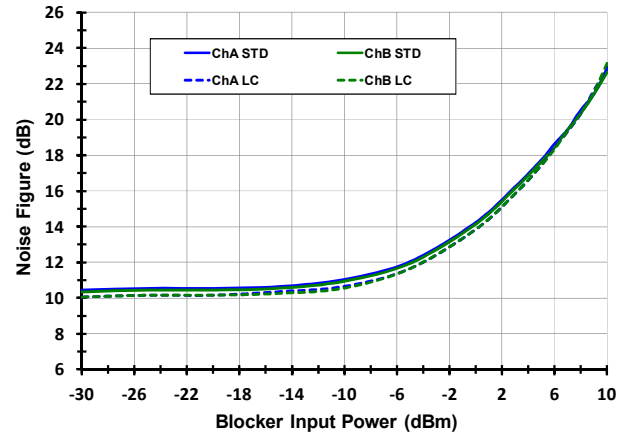

RF to IF Dual Downconverting Mixer

2300 - 2700 MHz F1162NBGI

TYPICAL OPERATING CONDITIONS [IF = 400 MHz, Low Side Injection] (-6-)

Gain vs. T<sub>CASE</sub>

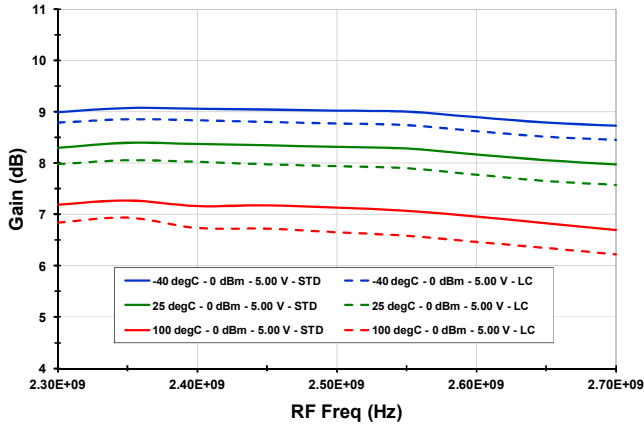

Gain vs. T<sub>CASE</sub> (EVKIT DE-EMBEDDED)

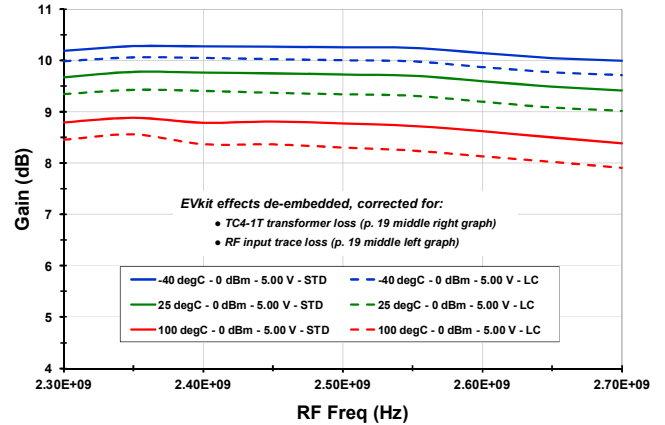

Gain vs. LO Level

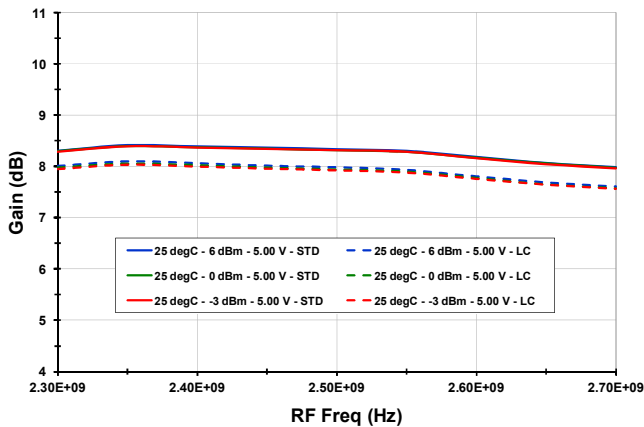

Output IP3 vs. T<sub>CASE</sub> (EVKIT DE-EMBEDDED)

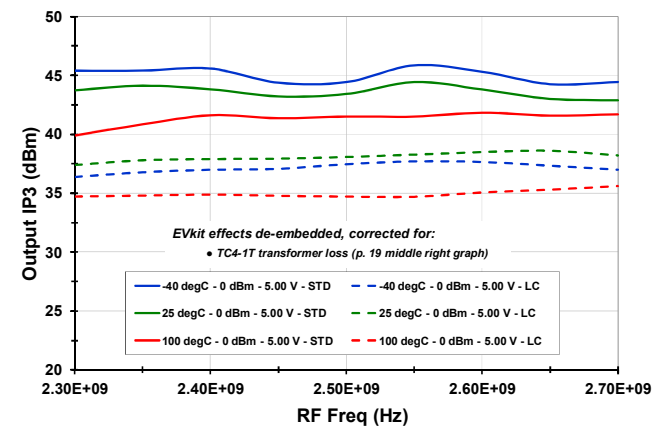

Output IP3 vs. V<sub>CC</sub> (EVKIT DE-EMBEDDED)

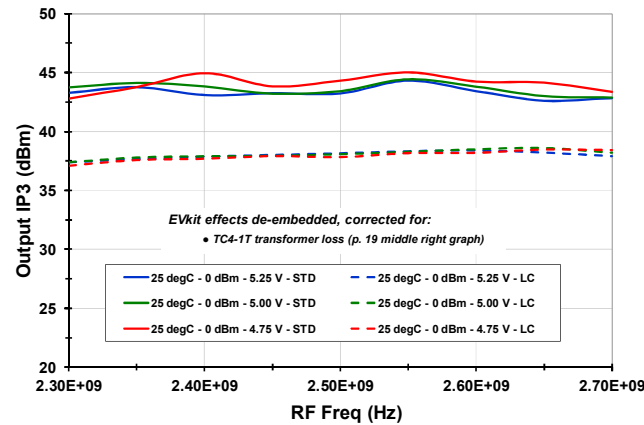

Output IP3 vs. LO Level (EVKIT DE-EMBEDDED)

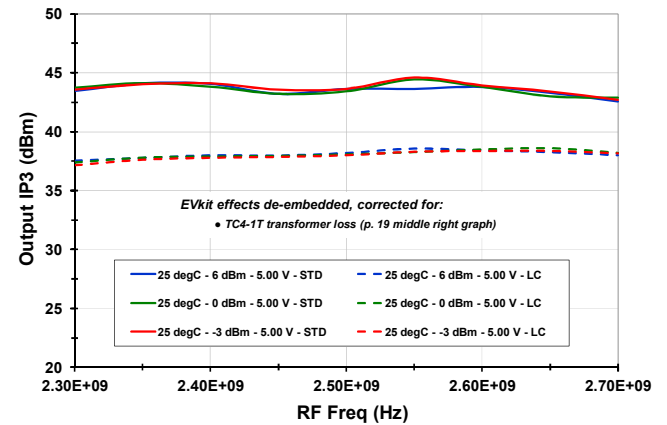

TYPICAL OPERATING CONDITIONS [IF = 400 MHz, Low Side Injection] (-7-)

P1dB vs. T<sub>CASE</sub>

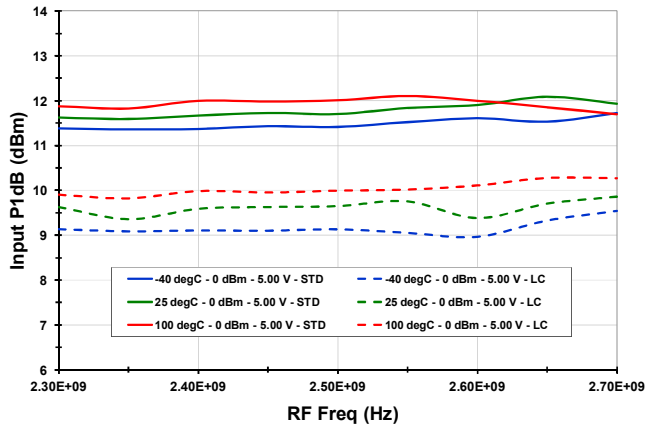

P1dB vs. V<sub>CC</sub>

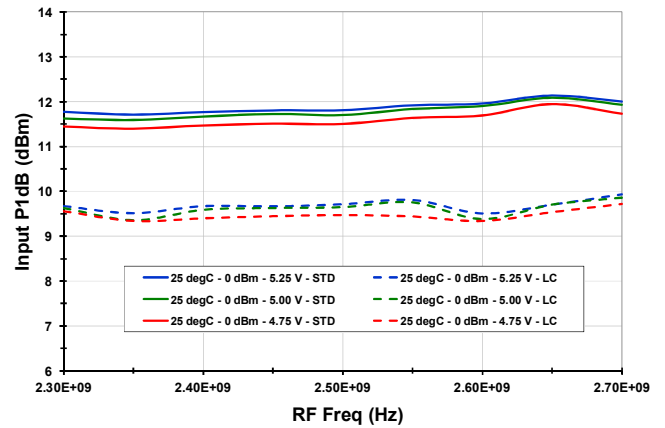

P1dB vs. LO Level

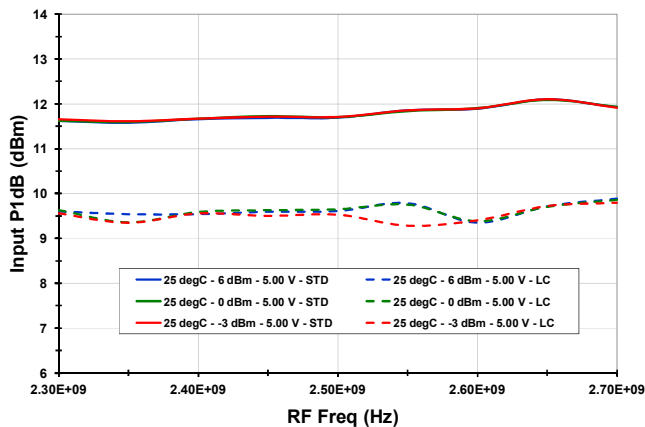

2RF x 2LO rejection vs. T<sub>CASE</sub>

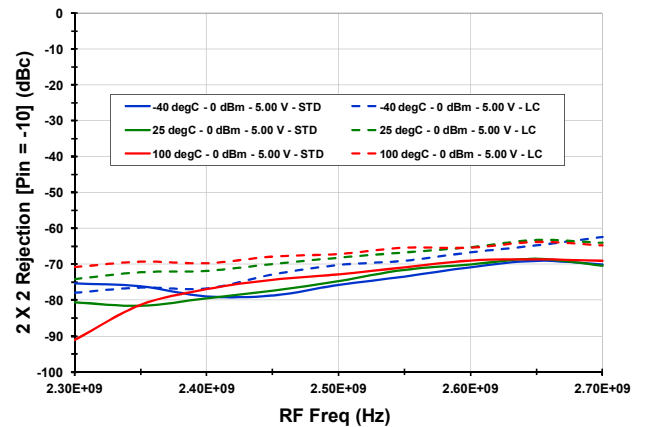

2RF x 2LO Rejection vs. V<sub>CC</sub>

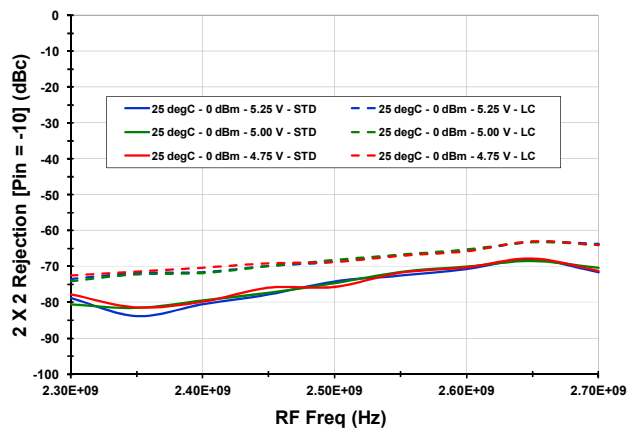

2RF x 2LO rejection vs. LO Level

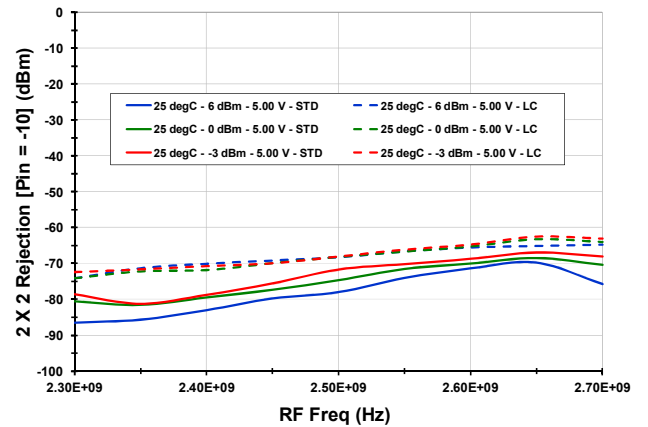

TYPICAL OPERATING CONDITIONS [IF = 400 MHz, Low Side Injection] (-8-)

I<sub>CC</sub> vs. T<sub>CASE</sub>

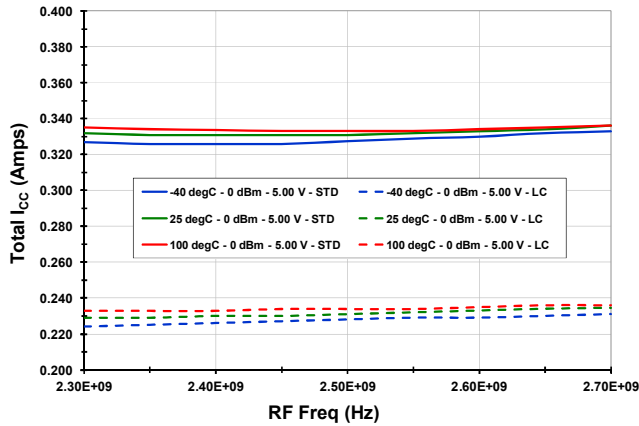

I<sub>CC</sub> vs. V<sub>CC</sub>

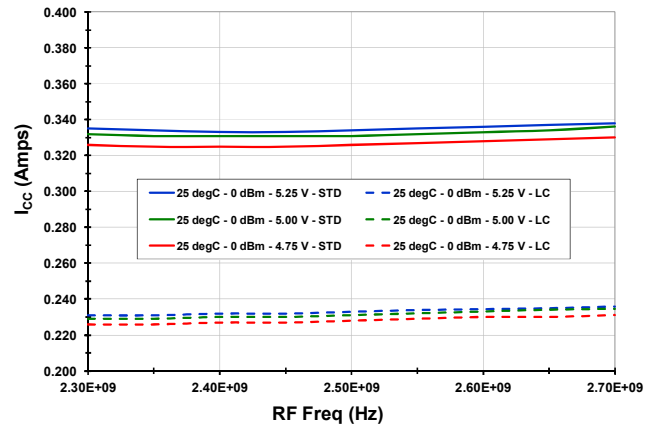

I<sub>CC</sub> vs. LO Level

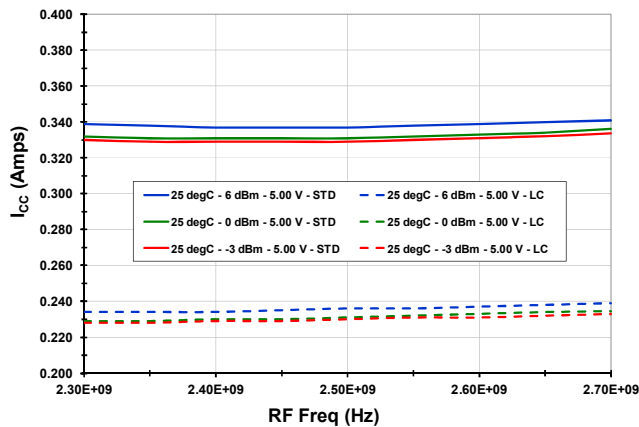

LO-IF Leakage vs. T<sub>CASE</sub>

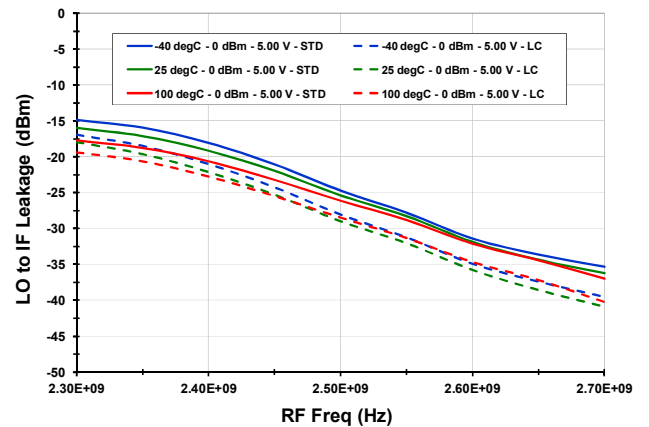

LO-IF Leakage vs. V<sub>CC</sub>

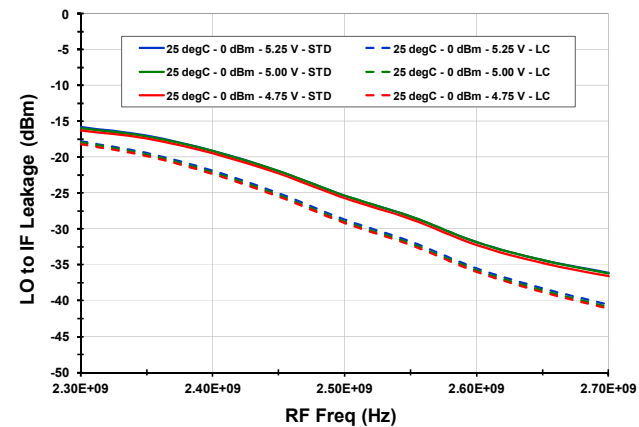

LO-IF Leakage vs. LO Level

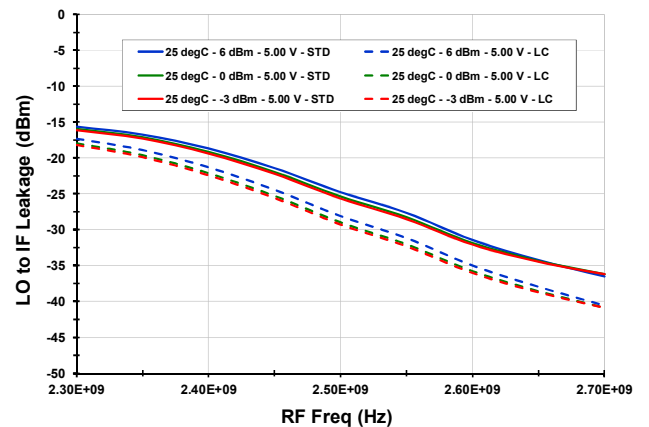

RF to IF Dual Downconverting Mixer

2300 - 2700 MHz F1162NBGI

TYPICAL OPERATING CONDITIONS [IF = 400 MHz, Low Side Injection] (-9-)

RF-IF Leakage vs. T<sub>CASE</sub>

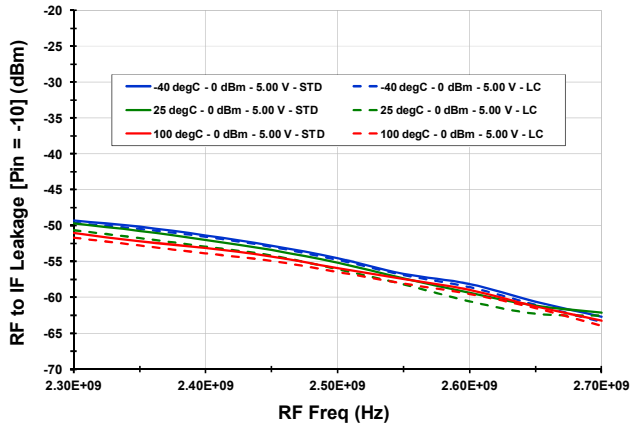

RF-IF Leakage vs. V<sub>CC</sub>

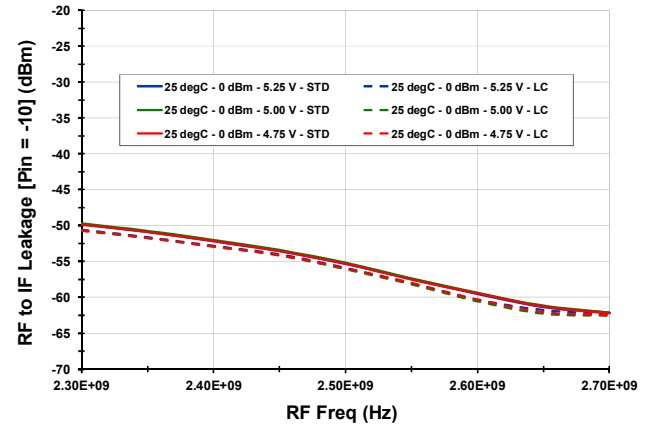

RF-IF Leakage vs. LO Level

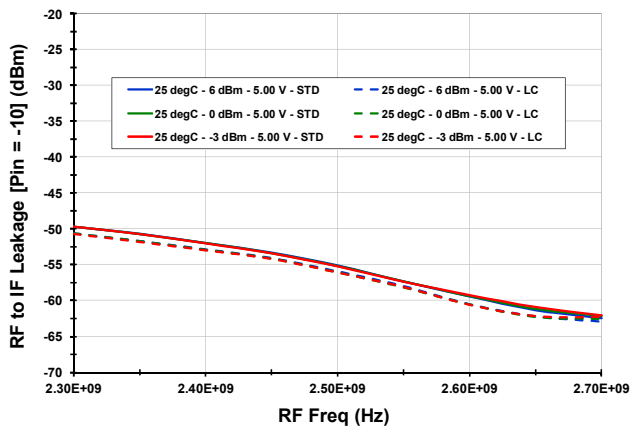

3RF X 3LO Rejection vs. T<sub>CASE</sub>

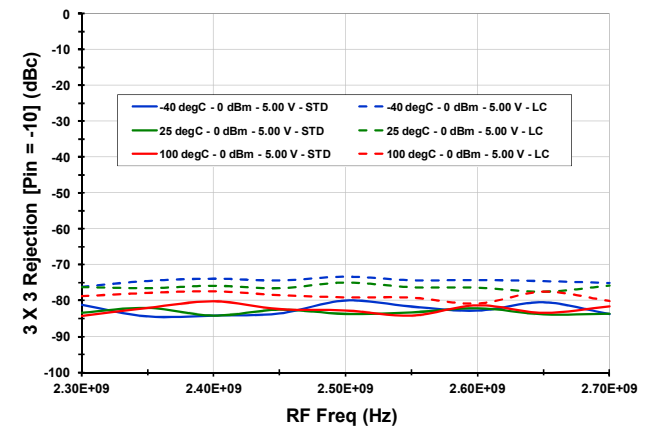

3RF X 3LO Rejection vs. V<sub>CC</sub>

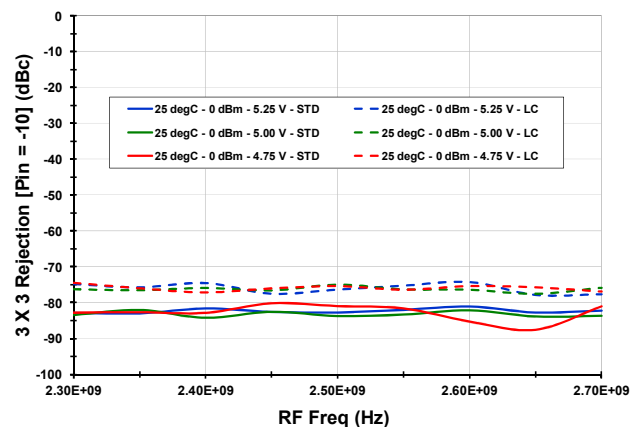

3RF X 3LO Rejection vs. LO Level

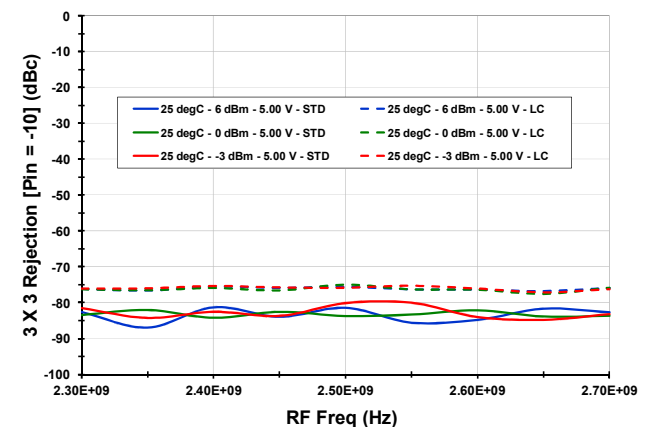

TYPICAL OPERATING CONDITIONS [High Side Injection see LC mode modifications on p. 25] (-10-)

Gain vs. T<sub>CASE</sub> (EVKIT DE-EMBEDDED)

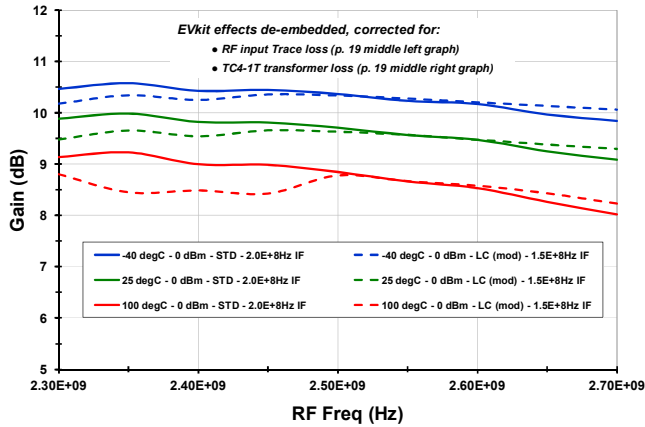

Gain vs. LO Level (EVKit de-embedded)

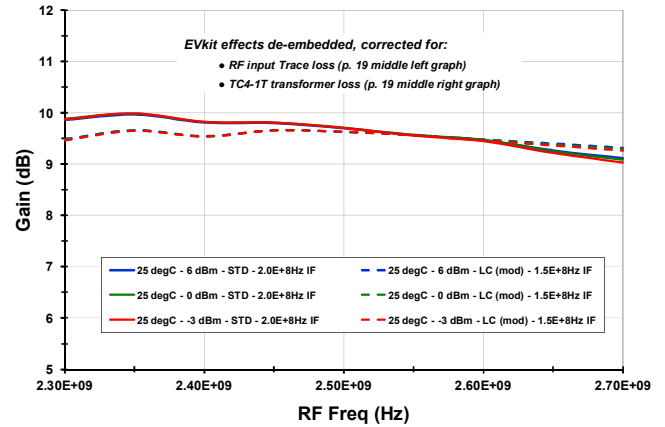

Output IP3 vs. T<sub>CASE</sub>

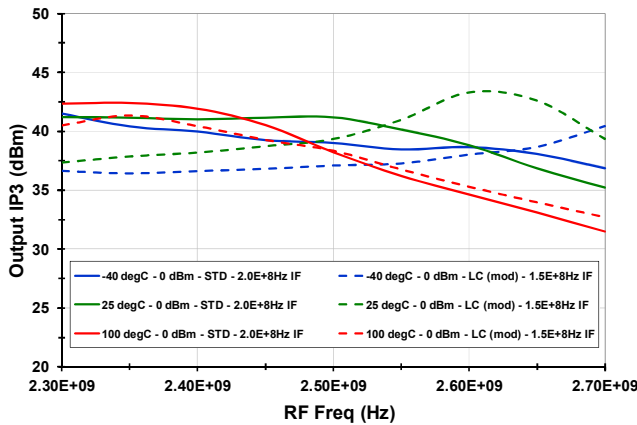

Output IP3 vs. LO Level

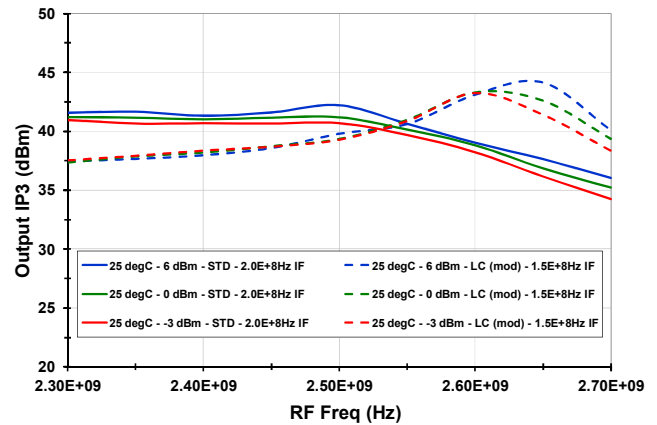

P1dB vs. T<sub>CASE</sub>

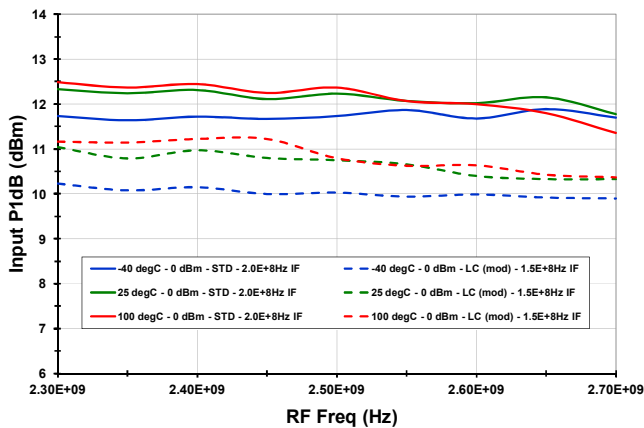

P1dB vs. LO Level

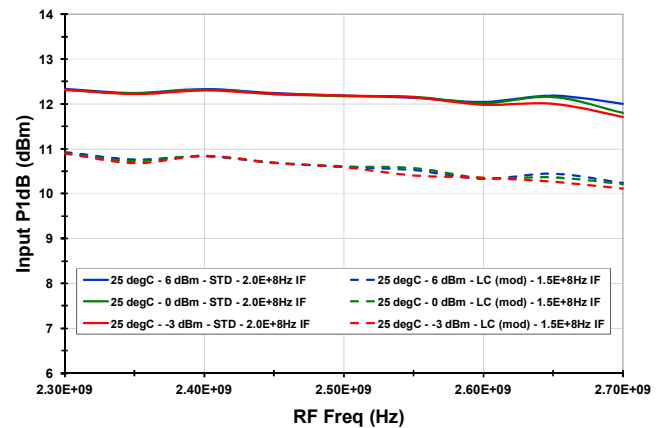

RF to IF Dual Downconverting Mixer

2300 - 2700 MHz F1162NBGI

TYPICAL OPERATING CONDITIONS [High Side Injection see LC mode modifications on p. 25] (-11-)

2RF x 2LO vs. T<sub>CASE</sub> [IF = 154 MHz]

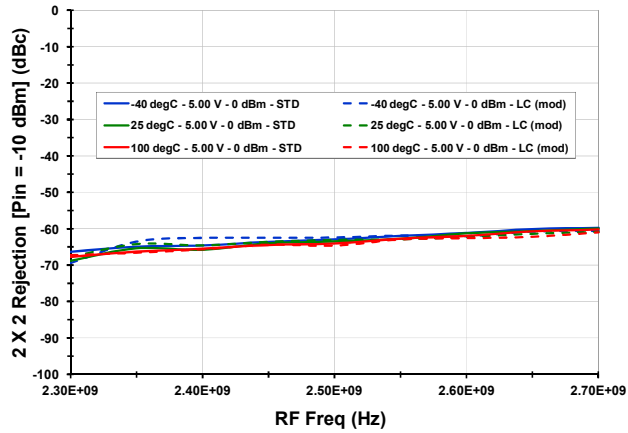

2RF x 2LO vs. LO Level [IF = 154 MHz]

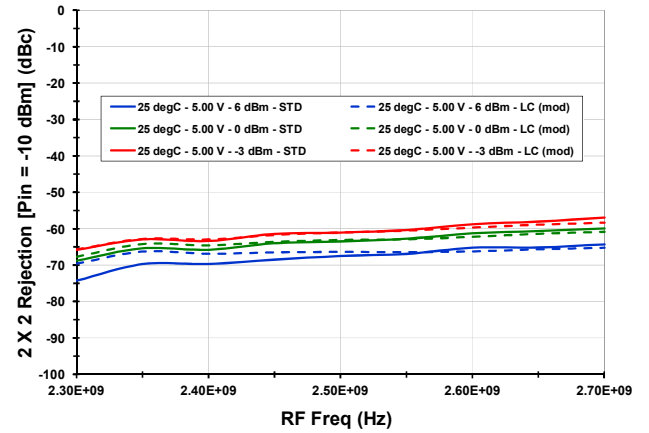

I<sub>CC</sub> vs. T<sub>CASE</sub>

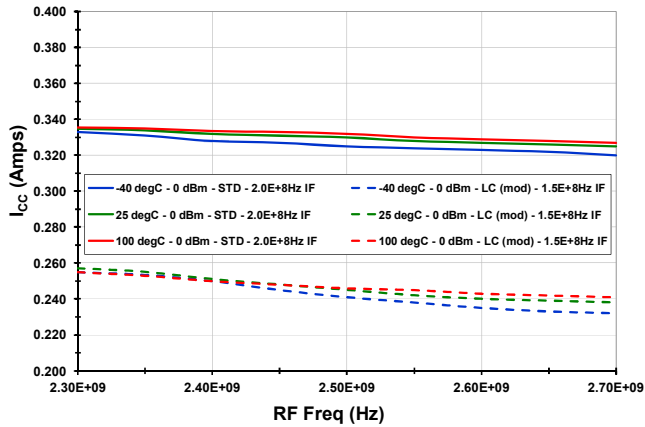

I<sub>CC</sub> vs. LO Level

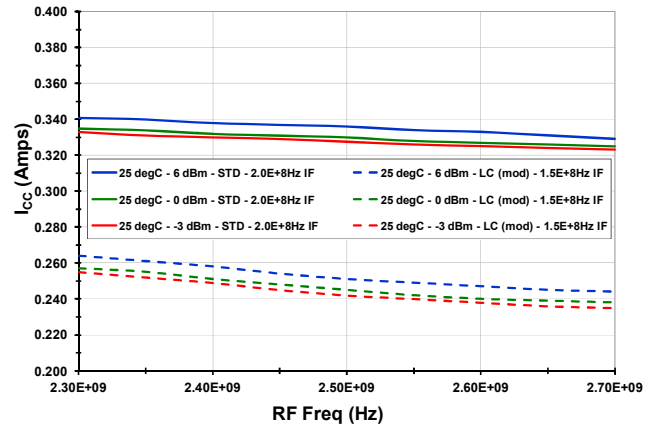

LO to IF Leakage vs. T<sub>CASE</sub>

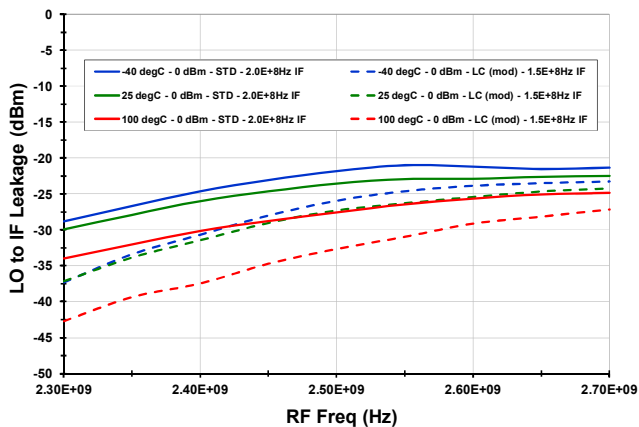

LO to IF Leakage vs. LO Level

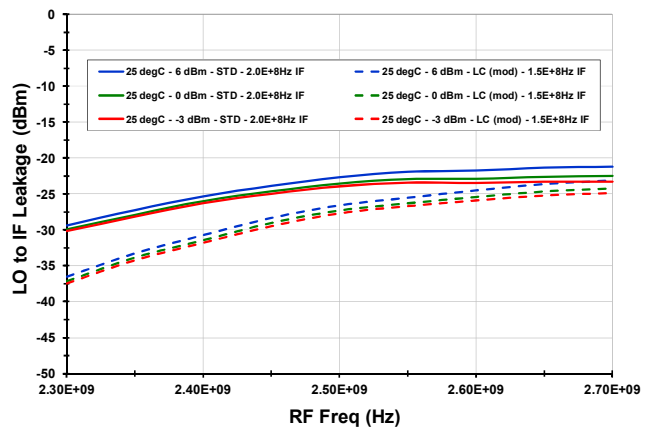



RF to IF Dual Downconverting Mixer

2300 - 2700 MHz F1162NBGI

TYPICAL OPERATING CONDITIONS [High Side Injection see LC mode modifications on p. 25] (-12-)

RF to IF Leakage vs. T<sub>CASE</sub>

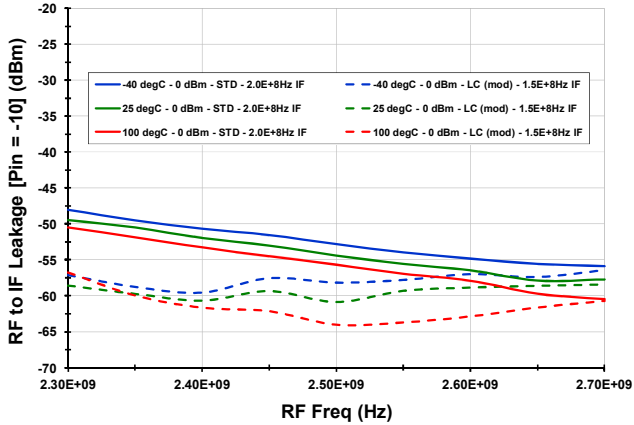

RF to IF Leakage vs. LO Level

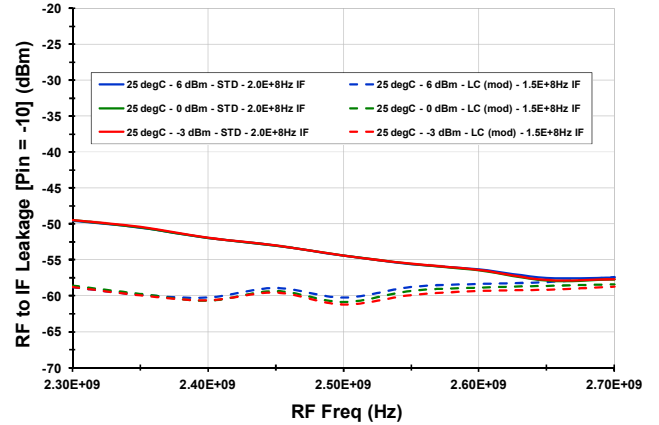

3RF x 3LO rejection vs. T<sub>CASE</sub> [IF = 154 MHz]

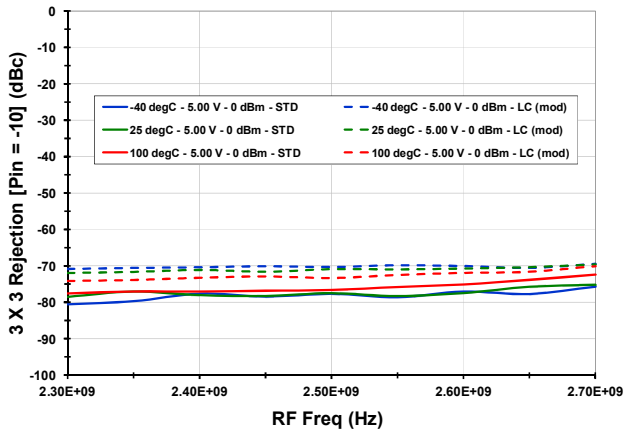

3RF x 3LO rejection vs. LO Level [IF = 154 MHz]

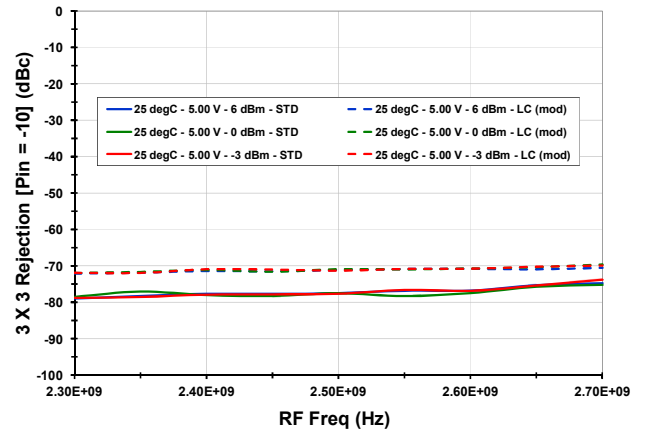

RF to IF Dual Downconverting Mixer

2300 - 2700 MHz F1162NBGI

TYPICAL OPERATING CONDITIONS [General] (-13-)

EVkit IF Port Match ( $T_A = 25C$ )

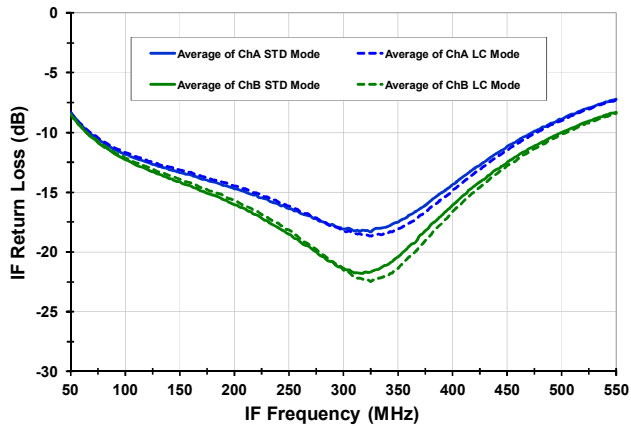

Alt. LO port Match ( $T_A = 25C, P_{MEAS} = 0 \text{ dBm}$ )

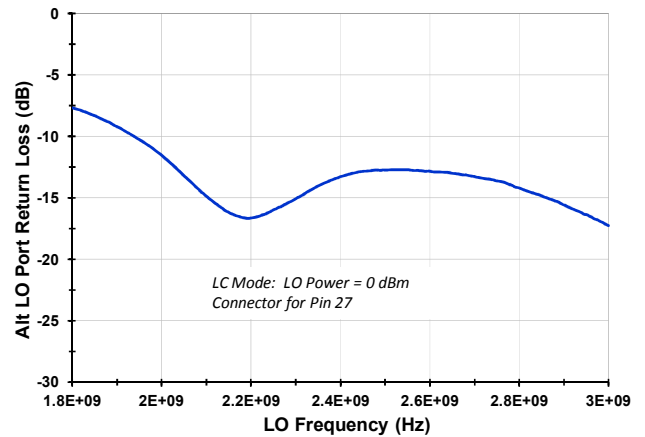

Settling Time (STBY ->  $V_{IL}$ )

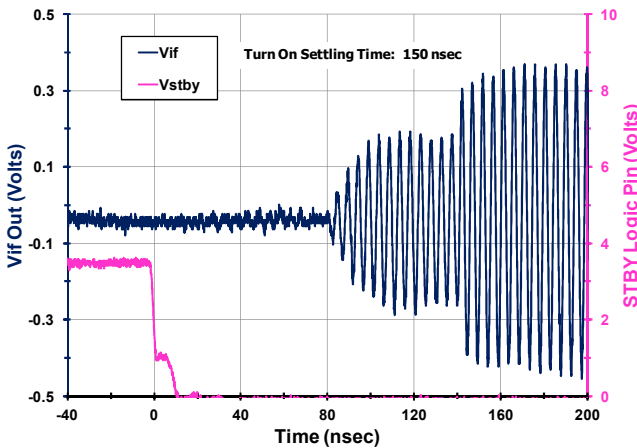

Settling Time (STBY ->  $V_{IH}$ )

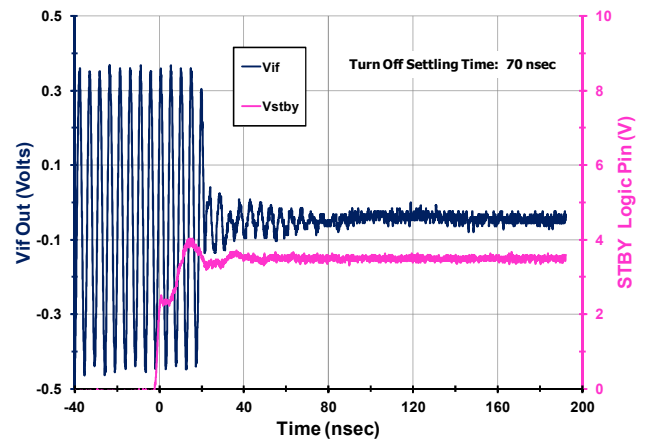

Main LO Port Match ( $T_A = 25C, P_{MEAS} = 0 \text{ dBm}$ )

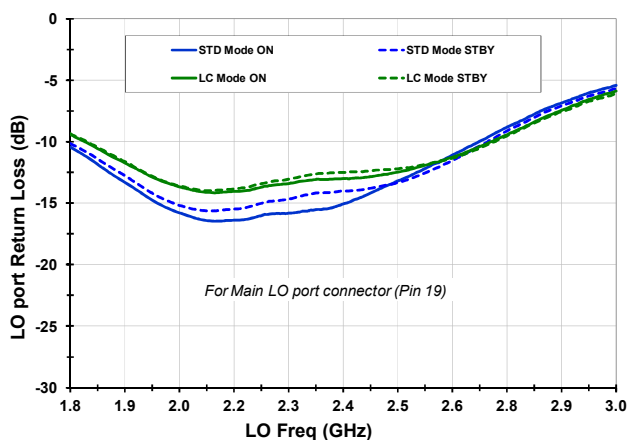

EVkit RF Port Match ( $T_A = 25C$ )

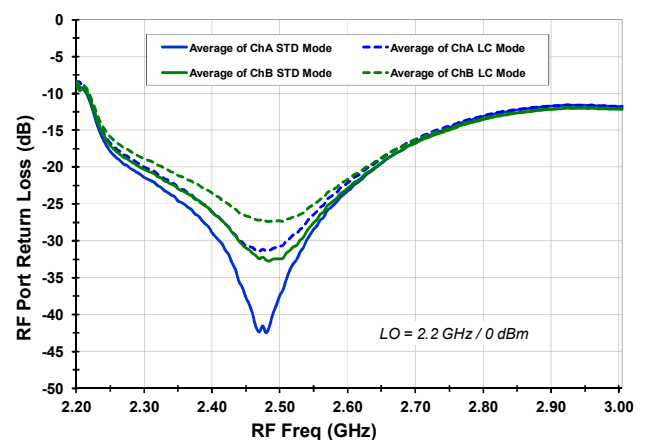

TYPICAL OPERATING CONDITIONS [General] (-14-)

IP<sub>3O</sub> vs. Δf (T<sub>A</sub> = 25C, Freq = 2.6 GHz, IF = 200 MHz)

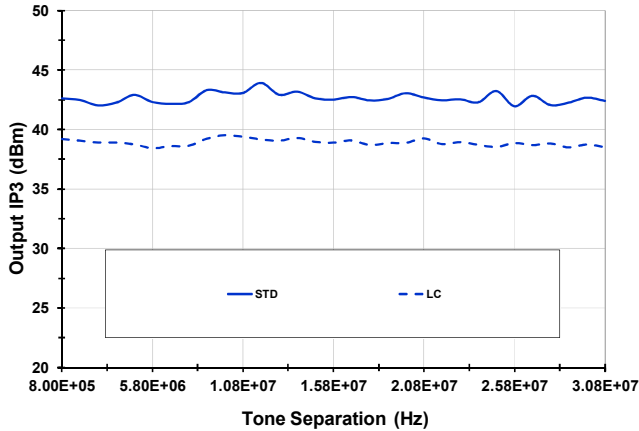

IP<sub>3O</sub> vs. P<sub>IN</sub> (T<sub>A</sub> = 25C, Freq = 2.6 GHz, IF = 200 MHz)

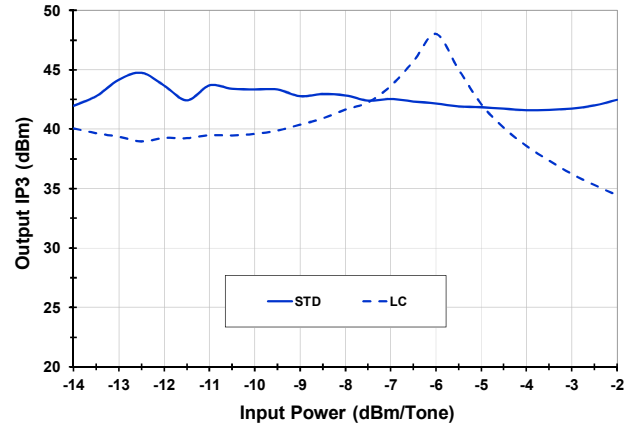

EVkit Input RF Trace Loss (T<sub>A</sub> = 25C)

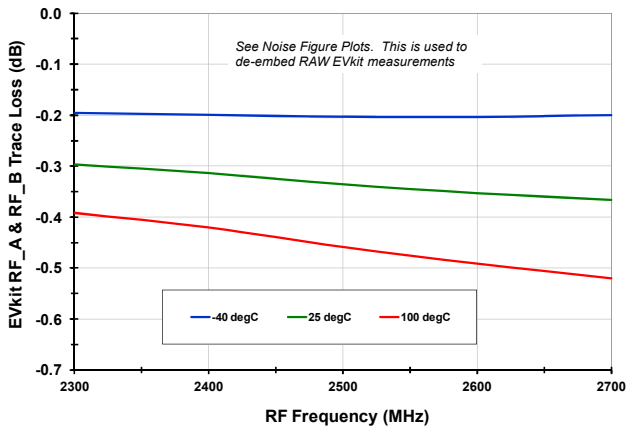

TC4-1T Transformer Loss

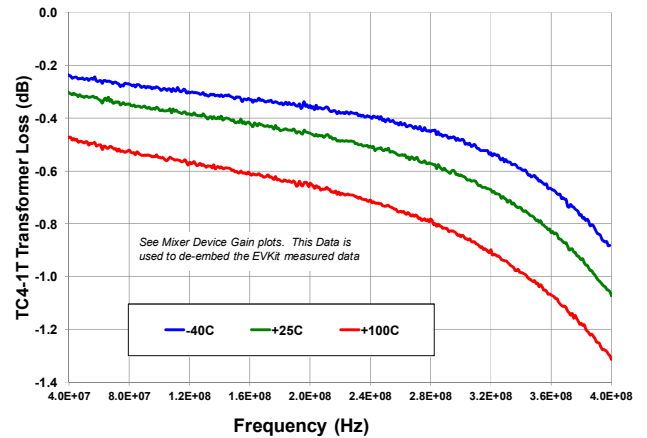

IP<sub>3O</sub> Distribution (F<sub>IF</sub> = 200MHz, LC mode, N = 3340)

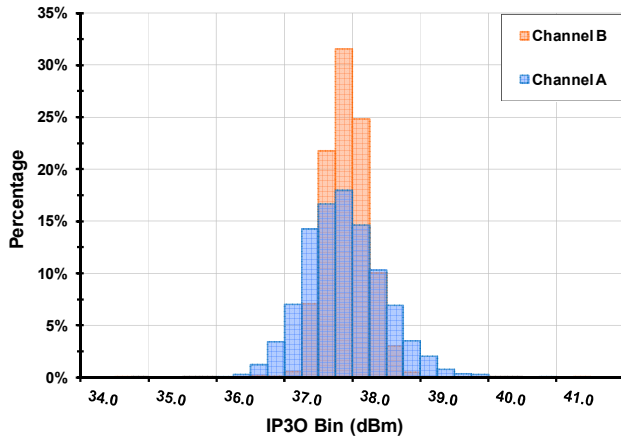

Gain Distribution (F<sub>IF</sub> = 400MHz, STD mode, N = 3340)

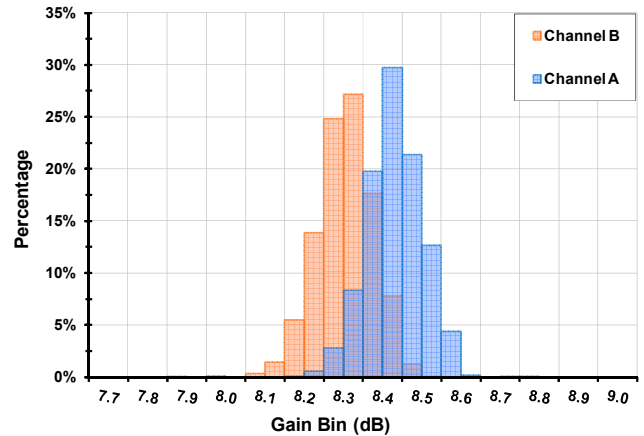

RF to IF Dual Downconverting Mixer

2300 - 2700 MHz F1162NBGI

PACKAGE DRAWING (6X6 QFN)

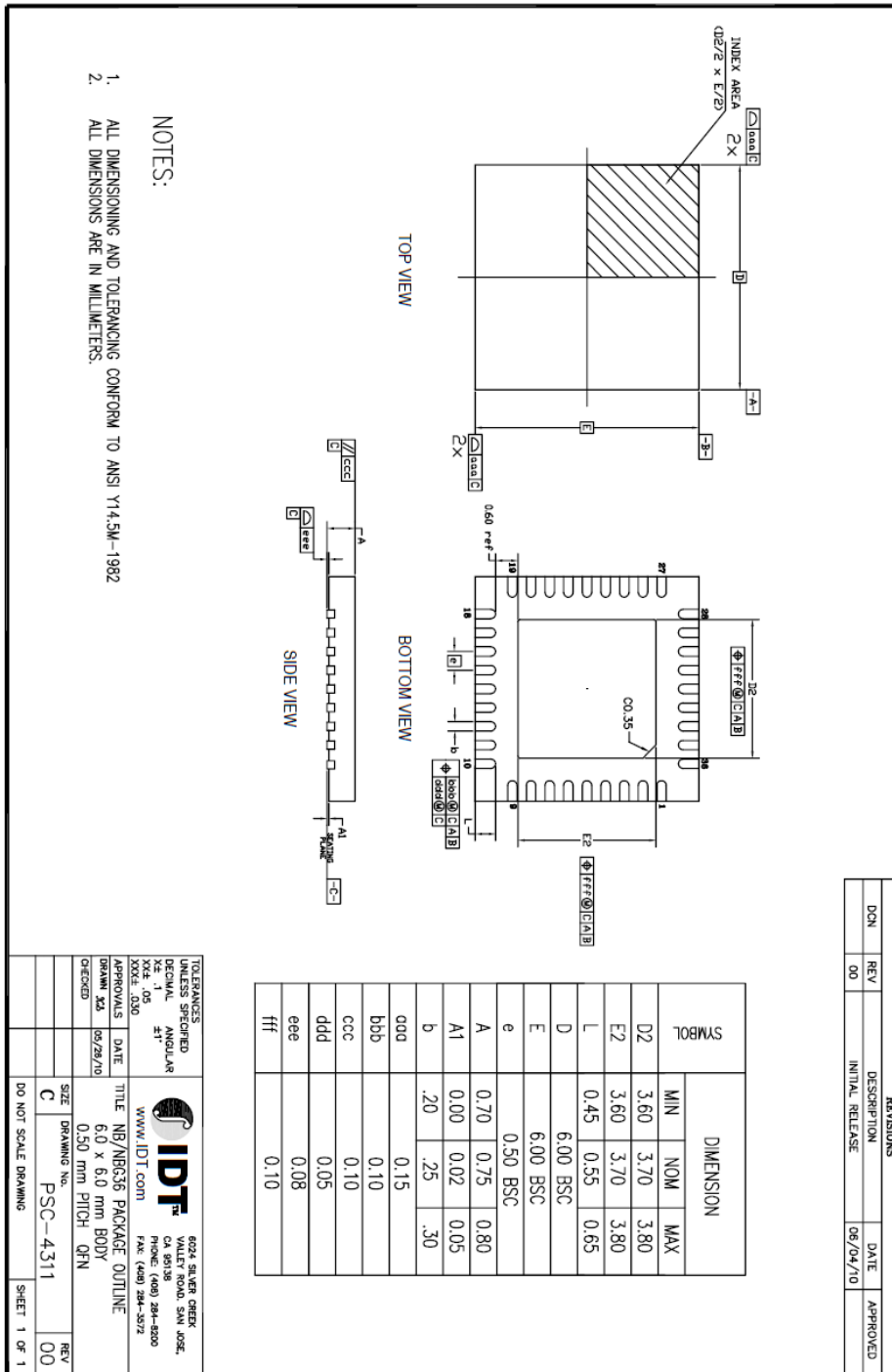

REVISIONS			
DCN	REV	DESCRIPTION	DATE
00	00	INITIAL RELEASE	08/04/10

TOLERANCES UNLESS SPECIFIED DECIMAL ANGULAR ±1°	6024 SILVER BRICK
XX ±.05	CA 95138
XXX ±.030	PHONE: (408) 284-8800
XXXX ±.020	FAX: (408) 284-3572
APPROVALS	DATE
DRW: XJS	08/29/10
CHECKED	
SIZE	DRAWING No.
C	PSC-4311
DO NOT SCALE DRAWING	REV
	00
	SHEET 1 OF 1

RF to IF Dual Downconverting Mixer

2300 - 2700 MHz F1162NBGI

PINOUTS

Black Text denotes recommended external connection

Red Text denotes internal Function or Connection

- DB GND = Downbonded to Paddle
- Internal NC = Pin not connected

Please Note!

- Only connect to one LO feed
- Choose Either Pin 19 or Pin 27
- Do not connect the unused LO pin to ensure good LO return loss

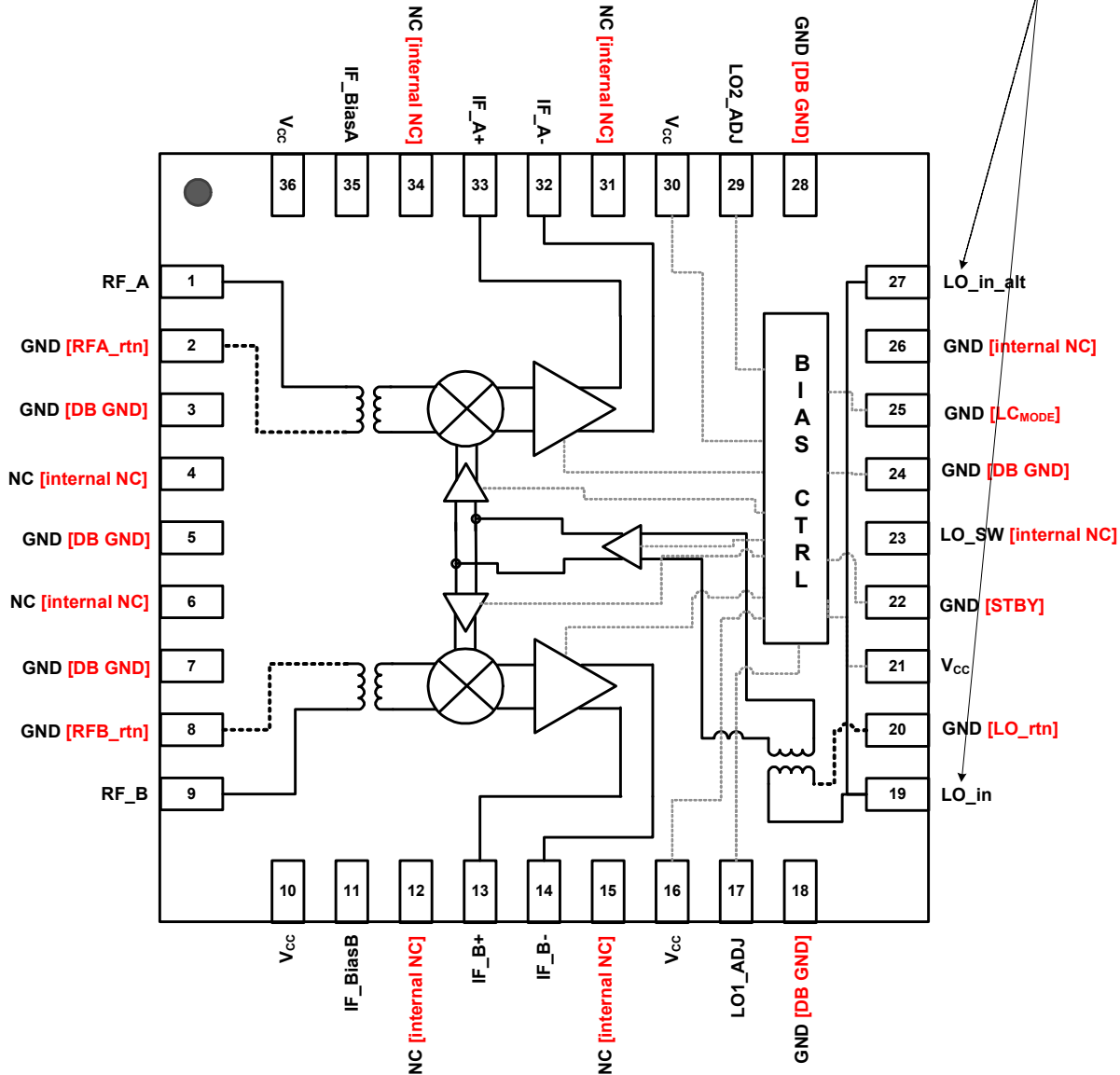

**PIN DESCRIPTIONS**

Pin	Name	Function
1	RF_A	Main Channel RF Input. Internally matched to 50Ω. DO NOT apply DC to these pins
2, 8, 20	RF_Artn, RF_Brtn, LO_rtn	Transformer Ground Returns. Ground these pins.
3, 5, 7, 18, 24, 28	GND	Ground these pins.
4, 6, 12, 15, 31, 23, 26, 34	N.C.	No Connection. Not internally connected. OK to connect to Vcc. OK to connect to GND
10, 16, 21, 30, 36	VCC	Power Supply. Bypass to GND with capacitors shown in the Typical Application Circuit as close as possible to pin.
9	RF_B	Diversity Channel RF Input. Internally matched to 50Ω
11	IF_BiasB	Connect the specified resistor from this pin to ground to set the bias for the Diversity IF amplifier. This is NOT a current set resistor
13, 14	IFB+, IFB-	Diversity Mixer Differential IF Output. Connect pullup inductors from each of these pins to VCC (see the Typical Application Circuit).
17	LO1_ADJ	Connect the specified resistor for either Standard or LC mode from this pin to ground to set the LO common buffer Icc
19, 27	LO_in LO_in_alt	Local Oscillator Input. Connect the LO to this port through the recommended coupling capacitor. <b>Note that you can only drive one LO port at a time. Remove the series capacitor from the unused port.</b>
25	LC_MODE	Low Current Mode. Set this pin to low or ground for LC mode. Set to high or No-Connect for Standard mode. There is an internal pull-up resistor.
22	STBY	STBY Mode. Pull this pin high for Standby mode (~20 mA). Pull low or Ground for normal Operation
29	LO2_ADJ	Connect the specified resistor for either Standard or LC mode from this pin to ground to set the LO drive buffers Icc
32, 33	IFA-, IFA+	Main Mixer Differential IF Output. Connect pullup inductors from each of these pins to VCC (see the Typical Application Circuit).
35	IF_BiasA	Connect the specified resistor from this pin to ground to set the bias for the Main IF amplifier. This is NOT a current set resistor
	— EP	Exposed Pad. Internally connected to GND. Solder this exposed pad to a PCB pad that uses multiple ground vias to provide heat transfer out of the device into the PCB ground planes. These multiple via grounds are also required to achieve the noted RF performance.

EVKIT SCHEMATIC

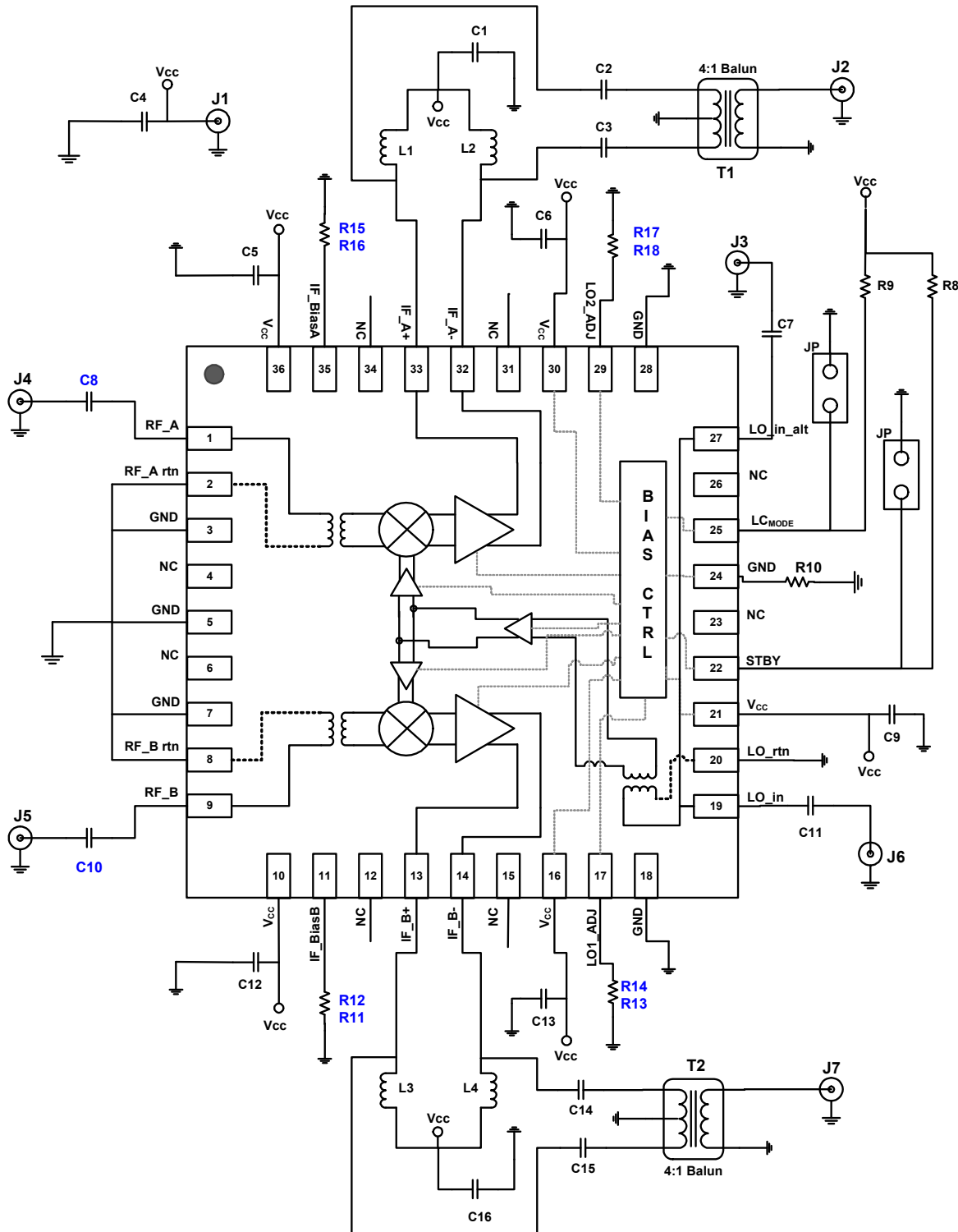

**EVKIT PICTURE/LAYOUT/OPERATION**

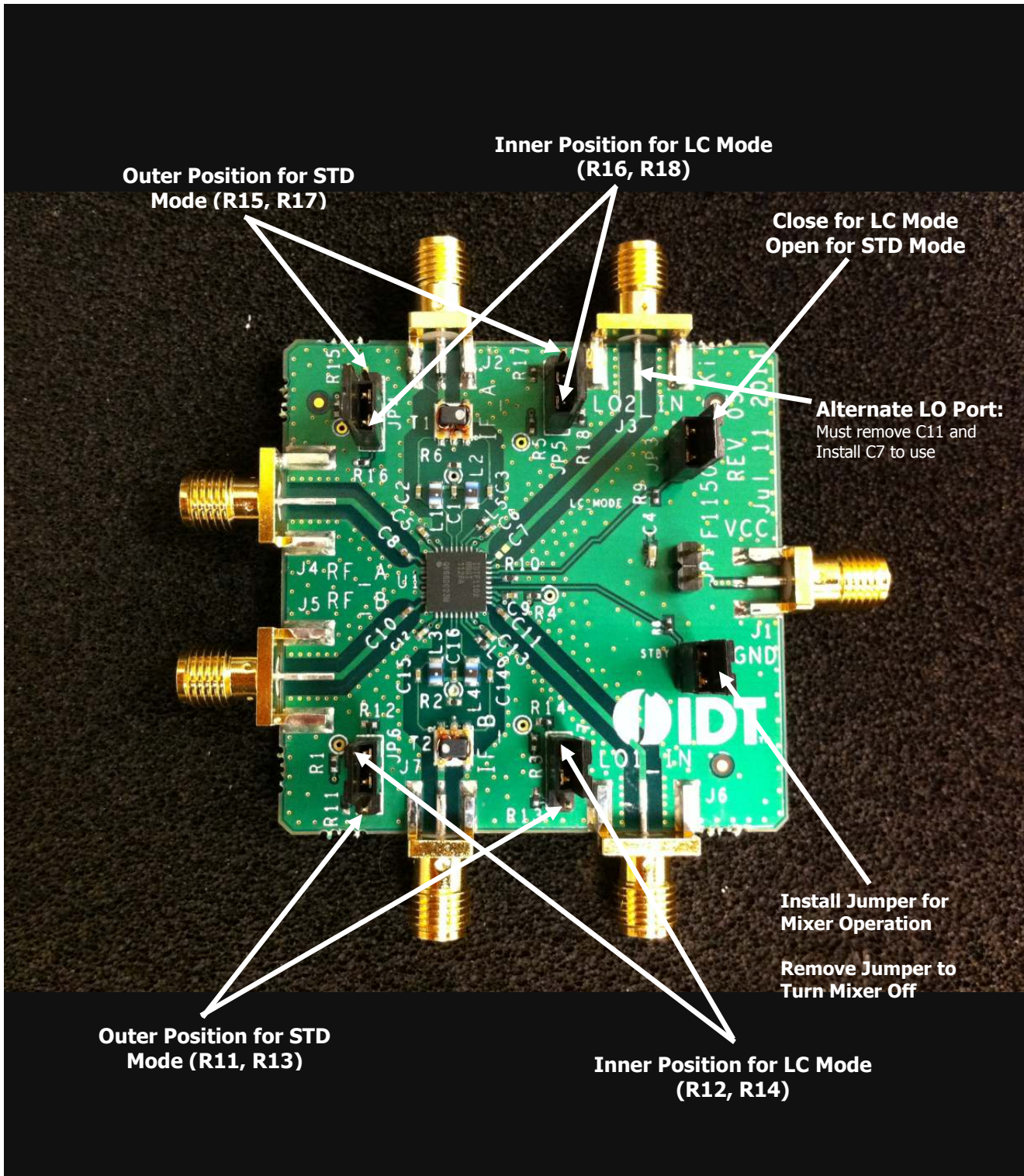



RF to IF Dual Downconverting Mixer

2300 - 2700 MHz F1162NBGI

**EVKIT BOM**

**Default BOM:**

For Standard Mode, Open the LC<sub>MODE</sub> jumper in conjunction with positioning the 4 dual jumpers to select the resistors in **red**.

For Low Current Mode close the LC<sub>MODE</sub> jumper in conjunction with positioning the 4 dual jumpers to select the resistors in **blue**.

**F1162 BOM**

Item #	Value	Size	Desc	Mfr. Part #	Mfr.	Part Reference	Qty
1	10nF	0402	CAP CER 1000PF 16V 10% X7R 0402	GRM155R71C103KA01D	MURATA	C1,5,6,9,12,13,16	7
2	1000pF	0402	CAP CER 1000PF 50V C0G 0402	GRM1555C1H102JA01D	MURATA	C2,3,14,15	4
3	39pF	0402	CAP CER 39PF 50V 5% C0G 0402	GRM1555C1H390JZ010	MURATA	C8,10	2
4	4.7pF	0402	CAP CER 4.7PF 50V 5% C0G 0402	GRM1555C1H4R7CZ01D	MURATA	C11	1
5	1pF	0402	Note: C7 and C11 cannot be installed together. C7 for Pin27 LO feed. C11 for Pin19 LO feed			C7	1
6	10uF	0603	CAP CER 10UF 6.3V X5R 0603	GRM188R60J106ME47D	MURATA	C4	1
7	Header 2 Pin	TH 2	CONN HEADER VERT SGL 2POS GOLD	961102-6404-AR	3M	JP1,2,3	3
8	Header 3 Pin	TH 3	CONN HEADER VERT SGL 3POS GOLD	961103-6404-AR	3M	JP4,5,6,7	4
9	SMA END LAUNCH	.062	SMA_END_LAUNCH	142-0711-821	Emerson Johnson	J1,2,3,4,5,6,7	7
10	270nH	0805	0805CS (2012) Ceramic Chip Inductor	0805CS-271XILB	COILCRAFT	L1,2,3,4	4
11	40	0402	RES 40 OHM 1/10W 1% 0402 SMD	ERJ-2RKF40R2X	Panasonic	R11,15	2
12	63	0402	RES 63 OHM 1/10W 1% 0402 SMD	ERJ-2RKF62R0X	Panasonic	R12,16	2
13	91	0402	RES 91.0 OHM 1/10W 1% 0402 SMD	ERJ-2RKF91R0X	Panasonic	R13	1
14	180	0402	RES 180 OHM 1/10W 1% 0402 SMD	ERJ-2RKF1800X	Panasonic	R14	1
15	1.91k	0402	RES 1.91K OHM 1/10W 1% 0402 SMD	ERJ-2RKF1911X	Panasonic	R18	1
16	1.21K	0402	RES 1.21K OHM 1/10W 1% 0402 SMD	ERJ-2RKF1211X	Panasonic	R17	1
17	47K	0402	RES 47.0K OHM 1/16W 1% 0402 SMD	RC0402FR-0747KL	Yageo	R8,9	2
18	0	0402	RES 0.0 OHM 1/10W 0402 SMD	ERJ-2GE0R00X	Panasonic	R1,2,3,4,5,6,7,10	8
19	4:1 Balun	SM-22	4:1 Center Tap Balun	TC4-1TG2+	Mini Circuits	T1,2	2
20	F1162	QFN-36	Diversity Downconverter	F1162NBGI	IDT	U1	1
21	PCB			F1162 EVKit Rev5			1

**Modified BOM (for High Side Injection LC Mode):**

EVkit Modifications for High Side Injection Low Current Mode (see TOCs on pages 15 – 17)

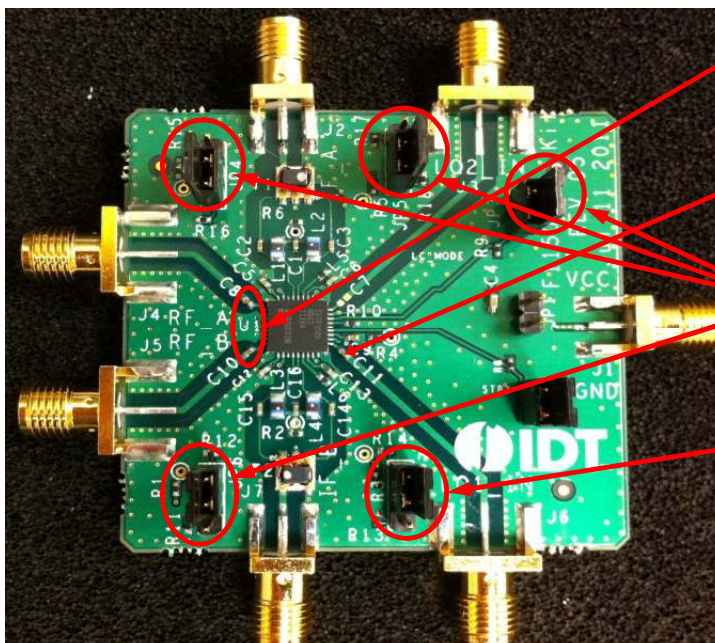

- Change C8 and C10 from 39 pF to 4.7 pF
- ↓
- Change C11 from 4.7 pF to 3 pF
- ↓
- Set these 3 Dual Jumpers as shown to INNER position and CLOSE LC<sub>MODE</sub> Jumper
- ↓
- Set R14/R13 Jumper to OUTER position
- ↓
- Will select 91 ohm resistor for pin17 instead of 180 ohm. All other resistors will be selected for Mode = Low Current

RF to IF Dual Downconverting Mixer

2300 - 2700 MHz F1162NBGI

## TOPMARKINGS

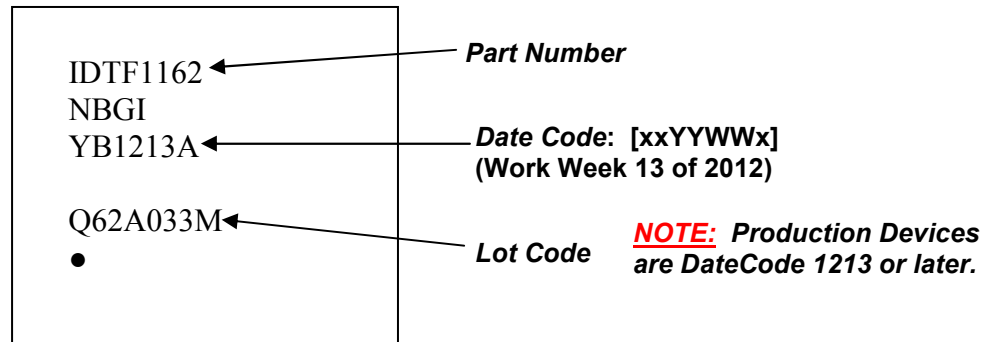

## IMPORTANT NOTICE AND DISCLAIMER

RENESAS ELECTRONICS CORPORATION AND ITS SUBSIDIARIES (“RENESAS”) PROVIDES TECHNICAL SPECIFICATIONS AND RELIABILITY DATA (INCLUDING DATASHEETS), DESIGN RESOURCES (INCLUDING REFERENCE DESIGNS), APPLICATION OR OTHER DESIGN ADVICE, WEB TOOLS, SAFETY INFORMATION, AND OTHER RESOURCES “AS IS” AND WITH ALL FAULTS, AND DISCLAIMS ALL WARRANTIES, EXPRESS OR IMPLIED, INCLUDING, WITHOUT LIMITATION, ANY IMPLIED WARRANTIES OF MERCHANTABILITY, FITNESS FOR A PARTICULAR PURPOSE, OR NON-INFRINGEMENT OF THIRD-PARTY INTELLECTUAL PROPERTY RIGHTS.

These resources are intended for developers who are designing with Renesas products. You are solely responsible for (1) selecting the appropriate products for your application, (2) designing, validating, and testing your application, and (3) ensuring your application meets applicable standards, and any other safety, security, or other requirements. These resources are subject to change without notice. Renesas grants you permission to use these resources only to develop an application that uses Renesas products. Other reproduction or use of these resources is strictly prohibited. No license is granted to any other Renesas intellectual property or to any third-party intellectual property. Renesas disclaims responsibility for, and you will fully indemnify Renesas and its representatives against, any claims, damages, costs, losses, or liabilities arising from your use of these resources. Renesas' products are provided only subject to Renesas' Terms and Conditions of Sale or other applicable terms agreed to in writing. No use of any Renesas resources expands or otherwise alters any applicable warranties or warranty disclaimers for these products.

(Disclaimer Rev.1.01 Jan 2024)

### Corporate Headquarters

TOYOSU FORESIA, 3-2-24 Toyosu,  
Koto-ku, Tokyo 135-0061, Japan  
[www.renesas.com](http://www.renesas.com)

### Trademarks

Renesas and the Renesas logo are trademarks of Renesas Electronics Corporation. All trademarks and registered trademarks are the property of their respective owners.

### Contact Information

For further information on a product, technology, the most up-to-date version of a document, or your nearest sales office, please visit [www.renesas.com/contact-us/](http://www.renesas.com/contact-us/).