

Description

The F1420 is a high gain / high linearity RF amplifier used in high-performance RF applications. The F1420 provides 17.4dB gain with +42dBm OIP3 and 4.5dB noise figure at 960MHz. This device uses a single 5V supply and 105mA of I_{CC} .

In typical base stations, RF amplifiers are used in the RX and TX traffic paths to boost signal levels. The F1420 amplifier offers very high reliability due to its construction using silicon die in a QFN package.

Competitive Advantage

In typical base stations, RF amplifiers are used in the RX and TX traffic paths to boost signal levels. The F1420 amplifier offers very high reliability due to its construction using silicon die in a QFN package.

Typical Applications

- Multi-mode, multi-carrier transmitters
- GSM850/900 base stations
- PCS1900 base stations
- DCS1800 base stations
- WiMAX and LTE base stations
- UMTS/WCDMA 3G base stations
- PHS/PAS base stations
- Public safety infrastructure

Features

- Broadband 700MHz to 1.1GHz
- 17.4dB typical gain at 960MHz
- 4.5dB noise figure at 960MHz
- +42dBm OIP3 at 960MHz
- +23.2dBm output P1dB at 960MHz
- Single 5V supply voltage
- $I_{CC} = 105\text{mA}$
- -40°C to $+105^{\circ}\text{C}$ operating temperature
- 50Ω single-ended input / output impedances
- Standby mode for power savings
- 4mm x 4mm, 24-pin QFN package

Block Diagram

Figure 1. Block Diagram

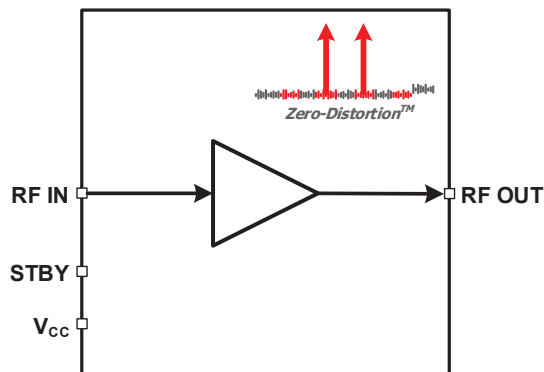

Pin Assignments

Figure 2. Pin Assignments for 4mm x 4mm x 0.9mm QFN Package – Top View

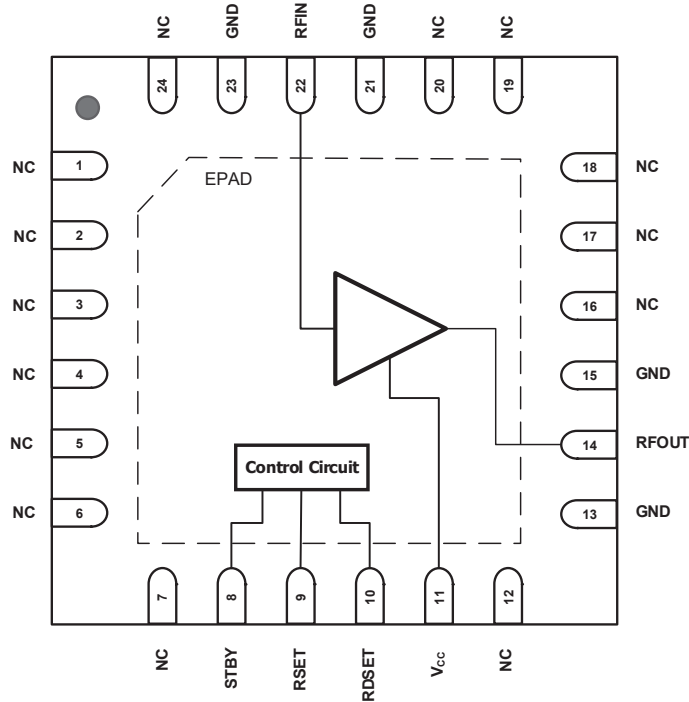

Pin Descriptions

Table 1. Pin Descriptions

| Number | Name | Description |
|----------------------------|-----------------|---|
| 1 - 7, 12, 16 - 19, 20, 24 | NC | No internal connection. These pins can be left unconnected, have a voltage applied, or be connected to ground (recommended). |
| 8 | STBY | Standby (HIGH = device power OFF, LOW/Open = device power ON). Internally this pin has a pull-down resistor that is connected to GND. |
| 9 | RSET | Amplifier bias current setting resistor. Connect 2.26kΩ resistor to ground. |
| 10 | RDSET | Amplifier 2nd bias current setting resistor. Connect 5.76kΩ resistor to ground. |
| 11 | V _{CC} | Power Supply for the Amplifier. |
| 13, 15, 21, 23 | GND | Internally grounded. These pins must be grounded as close to the device as possible. |
| 14 | RFOUT | RF output. Must use external DC block as close to the pin as possible. |
| 22 | RFIN | RF input internally matched to 50Ω. Must use external DC block. DC block should be placed as close to the pin for best RF performance. |
| | - EPAD | Exposed paddle. Internally connected to ground. Solder this exposed paddle to a printed circuit board (PCB) pad that uses multiple ground vias to provide heat transfer out of the device into the PCB ground planes. These multiple ground vias are also required to achieve the specified RF performance. |

Absolute Maximum Ratings

The absolute maximum ratings are stress ratings only. Stresses greater than those listed below can cause permanent damage to the device. Functional operation of the F1420 at absolute maximum ratings is not implied. Exposure to absolute maximum rating conditions may affect device reliability.

Table 2. Absolute Maximum Ratings

| Parameter | Symbol | Minimum | Maximum | Units |
|---|---------------|-----------------|-------------------|-------|
| Supply Voltage | V_{CC} | -0.3 | +5.5 | V |
| STBY | V_{STBY} | -0.3 | $V_{CC} + 0.25$ | V |
| RFIN Externally Applied DC Voltage | I_{RFIN} | -0.3 | +0.3 | V |
| RFOUT Externally Applied DC voltage | V_{RFOUT} | $V_{CC} - 0.15$ | $V_{CC} + 0.15$ | V |
| Maximum RF CW Input Power | P_{MAX_IN} | | +18 | dBm |
| Continuous Power Dissipation | P_{DISS} | | 1.5 | W |
| Junction Temperature | T_{JMAX} | | +150 | °C |
| Storage Temperature Range | T_{STOR} | -65 | +150 | °C |
| Lead Temperature (soldering, 10s) | T_{LEAD} | | +260 | °C |
| Electrostatic Discharge – HBM (JEDEC/ESDA JS-001-2012) | V_{ESDHBM} | | 2000 (Class 2) | V |
| Electrostatic Discharge – CDM (JEDEC 22-C101F) | V_{ESDCDM} | | 500 (Class C2) | V |

Recommended Operating Conditions

Table 3. Recommended Operating Conditions

| Parameter | Symbol | Condition | Minimum | Typical | Maximum | Units |
|--------------------------------------|----------------|-----------------|---------|---------|---------|----------|
| Supply Voltage | V_{CC} | | 4.75 | | 5.25 | V |
| Operating Temperature Range | T_{EP} | Exposed Paddle | -40 | | +105 | °C |
| RF Frequency Range | f_{RF} | Operating Range | 700 | | 1100 | MHz |
| Maximum Operating Input RF Power [a] | P_{OUT_MAX} | | | | +10 | dBm |
| RF Source Impedance | Z_{RFI} | Single Ended | | 50 | | Ω |
| RF Load Impedance | Z_{RFO} | Single Ended | | 50 | | Ω |

[a] Input / output load impedance < 2:1 VSWR any phase based in a 50 Ω system.

Electrical Characteristics

See the F1420 Typical Application Circuit. Specifications apply when operated at $V_{CC} = +5.0V$, $f_{RF} = 960MHz$, $T_{EP} = +25^{\circ}C$, $Z_S = Z_L = 50\Omega$, tone spacing = 5MHz, $P_{OUT} = +4dBm/$ tone, evaluation board (EVKit) traces and connectors are de-embedded, unless otherwise stated.

Table 4. Electrical Characteristics

| Parameter | Symbol | Condition | Minimum | Typical | Maximum | Units |
|------------------------------------|----------------------|---|----------------|------------|-------------|---------|
| Logic Input High Threshold | V_{IH} | | 1.1 [a] | | V_{CC} | V |
| Logic Input Low Threshold | V_{IL} | | | | 0.8 | V |
| Logic Current | I_{IL}, I_{IH} | Standby Pin | -10 | | 10 | μA |
| Supply Current | I_{CC} | Standby = LOW or open | | 105 | 120 | mA |
| | I_{CC_STBY} | Standby = HIGH | | 0.6 | 2 | mA |
| Gain | G_{700} | $f_{RF} = 700MHz$ | | 17.2 | | dB |
| | $G_{960\text{ LB}}$ | $f_{RF} = 960MHz$ | 16.4 | 17.4 | 18.4 | |
| | $G_{1100\text{ LB}}$ | $f_{RF} = 1100MHz$ | | 17.5 | | |
| Input Return Loss | RL_{IN} | | | 17 | | dB |
| Output Return Loss | RL_{OUT} | | | 14 | | dB |
| Gain Flatness | G_{FLAT} | | | 0.4 | | dB |
| Gain Ripple | G_{RIPPLE} | In any 20MHz range over RF Band | | ± 0.04 | | dB |
| Noise Figure | NF | $f_{RF} = 700MHz$ | | 4.6 | | dB |
| | | $f_{RF} = 960MHz$ | | 4.5 | | |
| | | $f_{RF} = 1100MHz$ | | 4.5 | | |
| | | $f_{RF} = 700MHz, T_{EP} = +105^{\circ}C$ | | 5.8 | | |
| Output Third Order Intercept Point | OIP3 | $f_{RF} = 750MHz$ to 960MHz $P_{OUT} = +4dBm/$ tone 5MHz tone delta | 38 | 42 | | dBm |
| Output 1dB Compression | OP1dB | | 20 | 23.2 | | dBm |
| Power ON Switching Time | t_{ON} | 50% STBY control to within 0.2dB of the on state final gain value | | 120 | | ns |
| Power OFF Switching Time | t_{OFF} | 50% STBY control to 30 dB below on state gain value | | 80 | | ns |

[a] Specifications in the minimum/maximum columns that are shown in **bold italics** are guaranteed by test. Specifications in these columns that are not shown in bold italics are guaranteed by design characterization.

Thermal Characteristics

Table 5. Package Thermal Characteristics

| Parameter | Symbol | Value | Units |
|--|-------------------|-------|-------|
| Junction to Ambient Thermal Resistance | θ_{JA} | 45 | °C/W |
| Junction to Case Thermal Resistance (Case is defined as the exposed paddle) | θ_{JC-BOT} | 36 | °C/W |
| Moisture Sensitivity Rating (Per J-STD-020) | | MSL 1 | |

Typical Operating Conditions (TOC)

- $V_{cc} = 5.0V$
- $Z_L = Z_S = 50\Omega$ Single Ended
- $f_{RF} = 960MHz$
- $T_{EP} = 25^\circ C$ (All temperatures are referenced to the exposed paddle)
- STBY = LOW (0V)
- $P_{out} = +4dBm/Tone$
- 5MHz Tone Spacing
- Evaluation Kit traces and connector losses are de-embedded

Typical Performance Characteristics

Figure 3. Gain vs Frequency

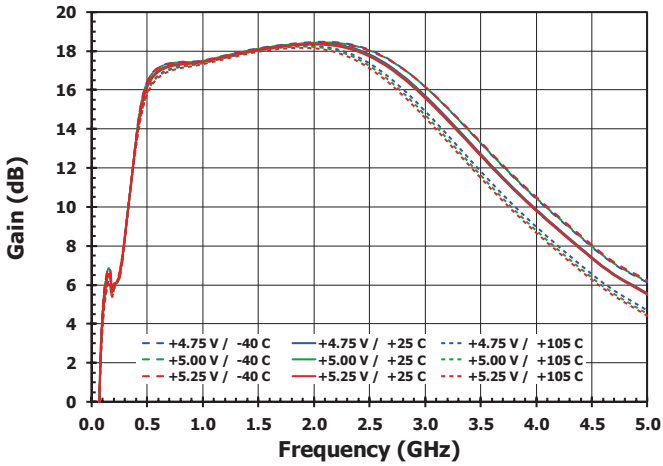

Figure 4. Reverse Isolation vs Frequency

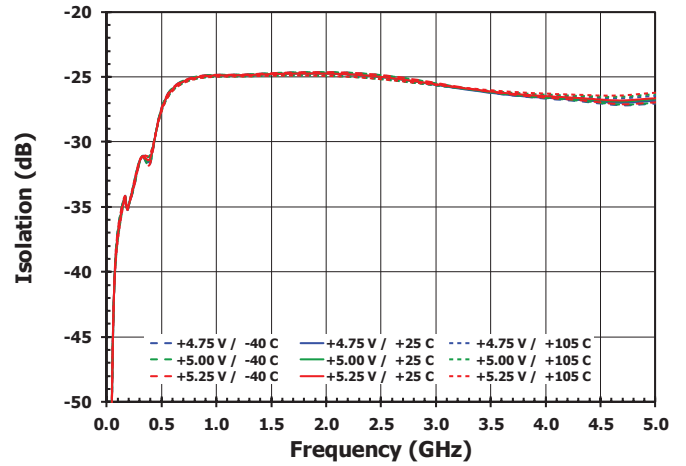

Figure 5. Input Return Loss vs Frequency

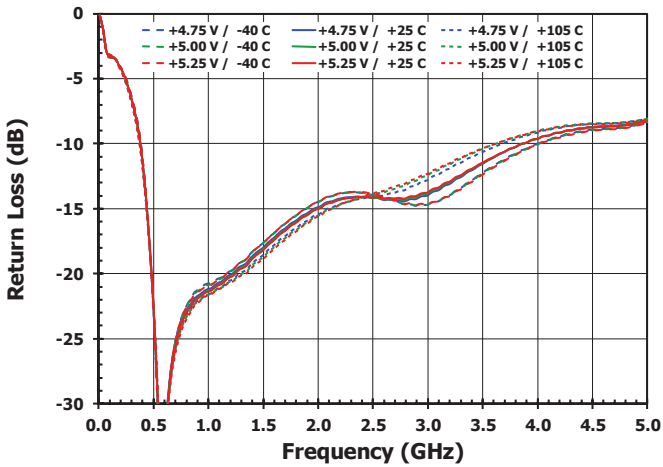

Figure 6. Output Return Loss vs Frequency

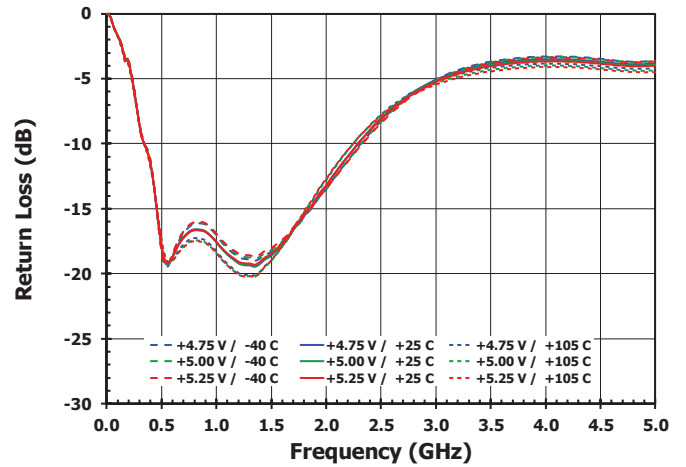

Figure 7. Gain vs Frequency

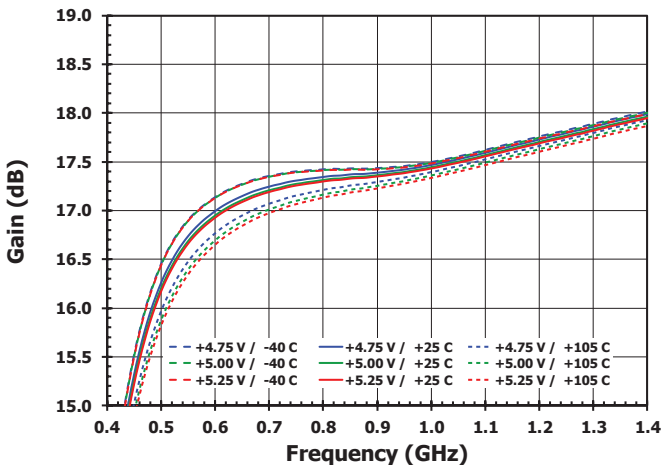
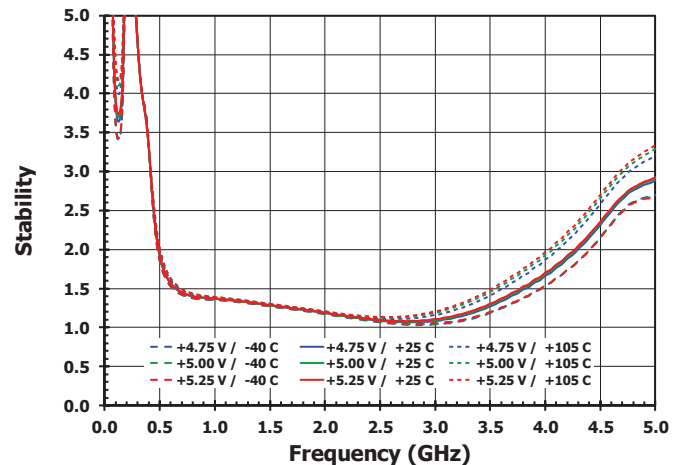

Figure 8. Stability vs Frequency



Typical Performance Characteristics

Figure 9. Output IP3 versus Frequency

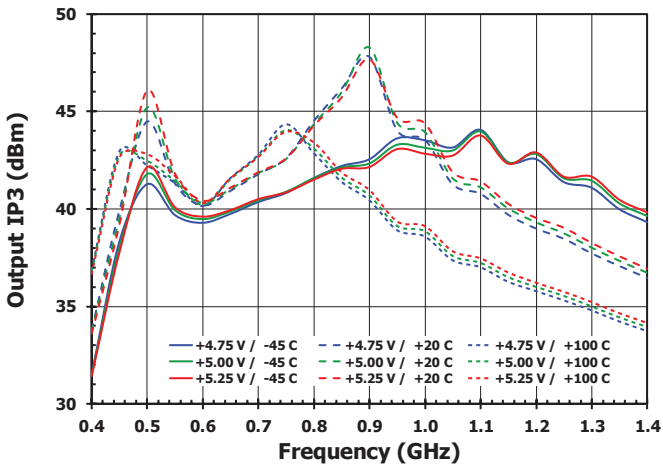

Figure 11. Second Harmonic versus Frequency

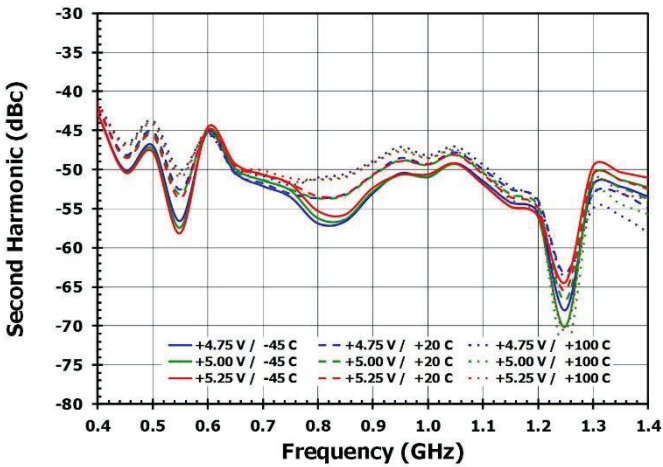

Figure 13. Noise Figure versus Frequency

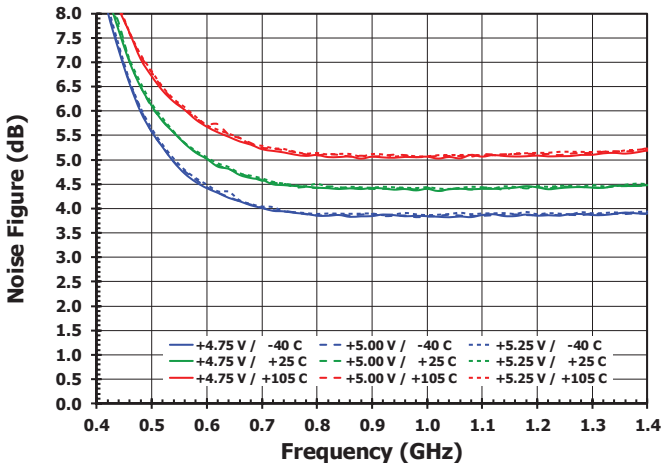

Figure 10. Output P1dB versus Frequency

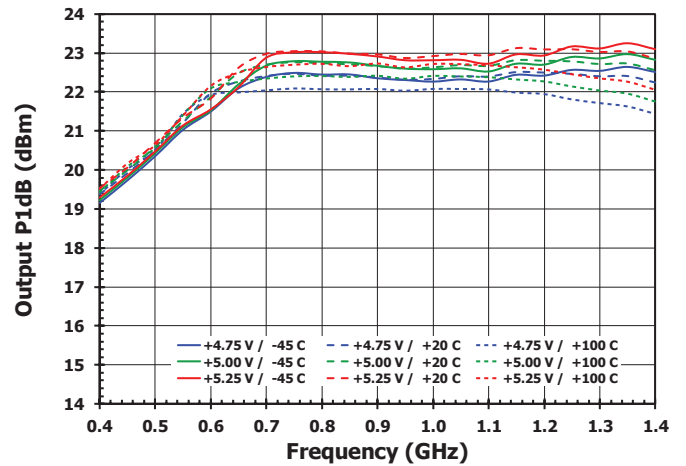

Figure 12. Third Harmonic versus Frequency

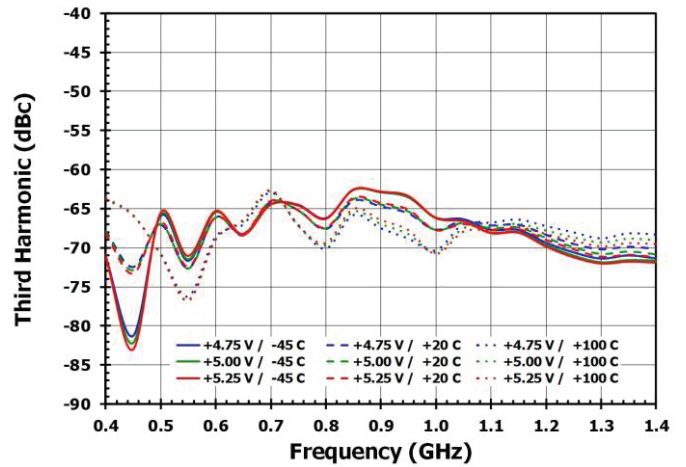
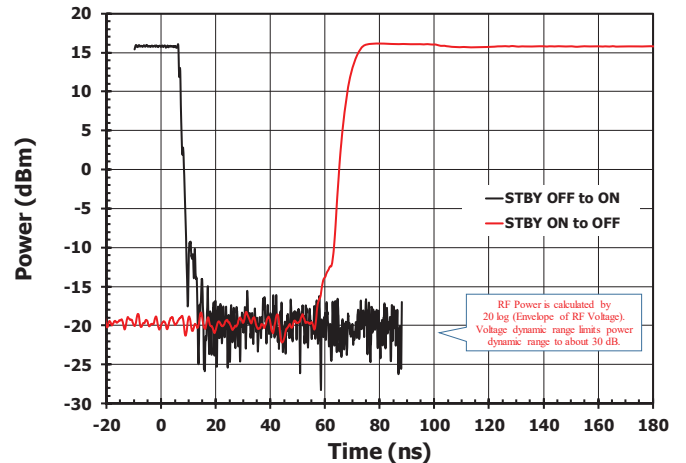

Figure 14. Standby Switching Speed



Evaluation Kit Picture

Figure 15. Top View

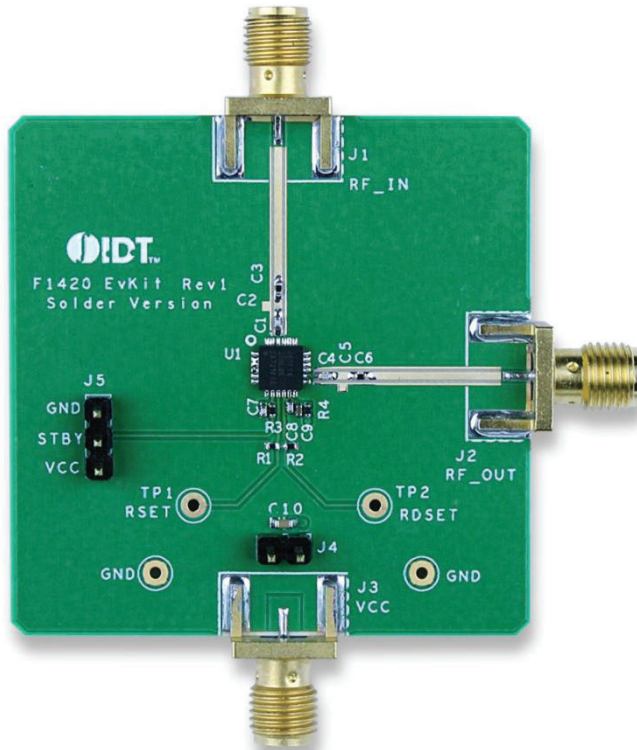
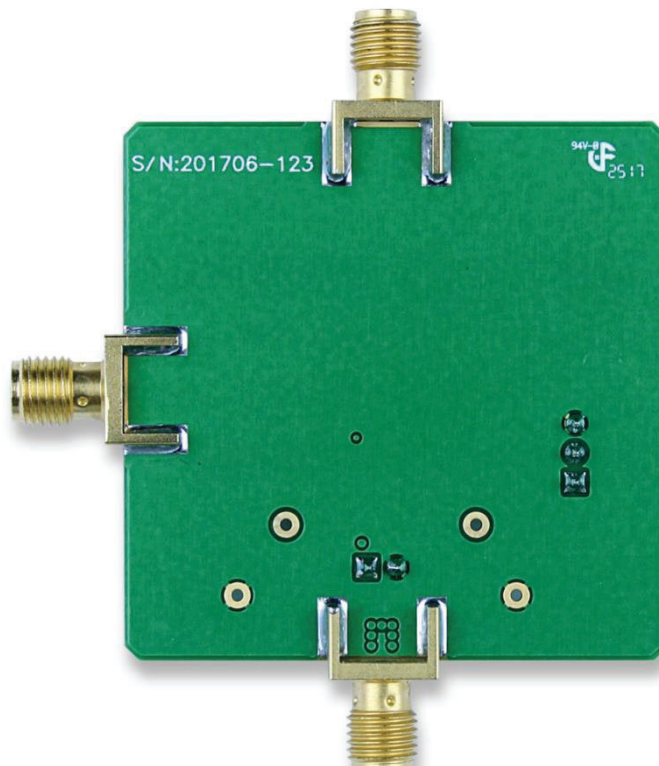

Figure 16. Bottom View



Evaluation Kit / Applications Circuit

Figure 17. Electrical Schematic

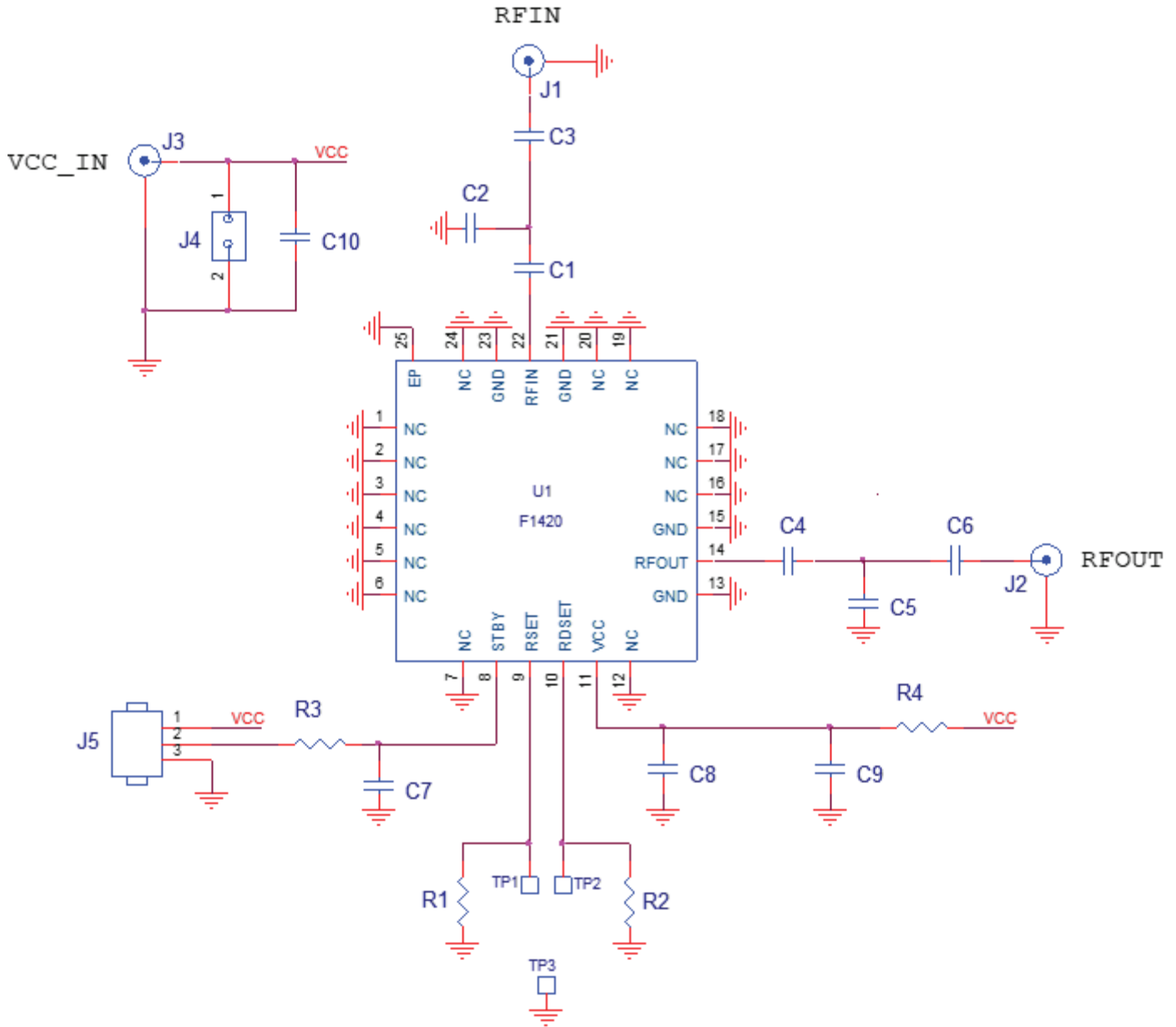

Table 6. Bill of Material (BOM)

| Part Reference | QTY | Description | Manufacturer Part # | Manufacturer |
|----------------|-----|--|---------------------|-----------------|
| C1, C4 | 2 | 47pF \pm 5%, 50V, C0G Ceramic Capacitor (0402) | GRM1555C1H470J | Murata |
| C7 | 1 | 2pF \pm 0.1pF, 50V, C0G Ceramic Capacitor (0402) | GRM1555C1H2R0B | Murata |
| C8 | 1 | 1000pF \pm 5%, 50V, C0G Ceramic Capacitor (0402) | GRM1555C1H102J | Murata |
| C9 | 1 | 0.1 μ F \pm 10%, 16V, X7R Ceramic Capacitor (0402) | GRM155R71C104K | Murata |
| C10 | 1 | 10 μ F \pm 20%, 16V, X6S Ceramic Capacitor (0603) | GRM188C81C106M | Murata |
| R1 | 1 | 2.26k Ω \pm 1%, 1/10W, Resistor (0402) | ERJ-2RKF2261X | Panasonic |
| R2 | 1 | 5.76k Ω \pm 1%, 1/10W, Resistor (0402) | ERJ-2RKF5761X | Panasonic |
| R3 | 1 | 1k Ω \pm 1%, 1/10W, Resistor (0402) | ERJ-2RKF1001X | Panasonic |
| C3, C6, R4 | 3 | 0 Ω Resistors (0402) | ERJ-2GE0R00X | Panasonic |
| J4 | 1 | CONN HEADER VERT SGL 2 X 1 POS GOLD | 961102-6404-AR | 3M |
| J5 | 1 | CONN HEADER VERT SGL 3 X 1 POS GOLD | 961103-6404-AR | 3M |
| J1, J2, J3 | 3 | Edge Launch SMA (0.375 inch pitch ground, tab) | 142-0701-851 | Emerson Johnson |
| U1 | 1 | AMP | F1420NLGK | IDT |
| | 1 | Printed Circuit Board | F1420 EVKit REV 1 | IDT |
| C2, C5 | | DNP | GRM1555C1H470J | Murata |

Evaluation Kit Operation

Power Supply Setup

Set up a power supply in the voltage range of 3.0V to 5.25V with the power supply output disabled. The voltage can be applied via one of the following connections (see Figure 18):

- J3 connector
- J4 header connection (note the polarity of the GND pin on this connector)

Figure 18. Power Supply Connections

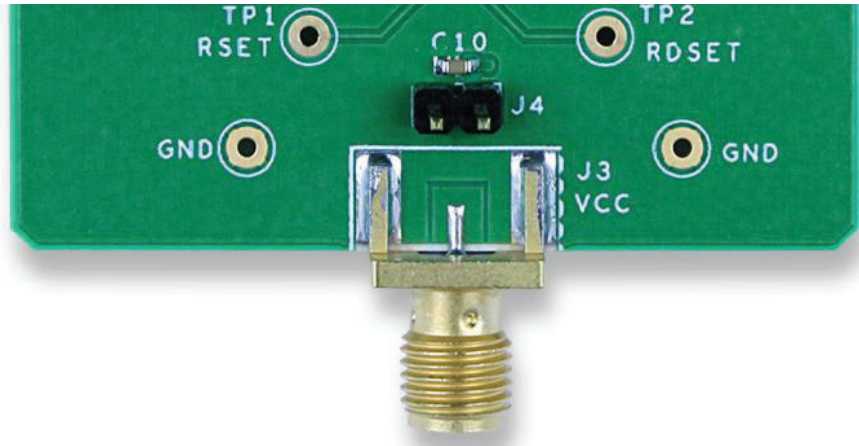

Standby (STBY) Pin

The Evaluation Board has the ability to control the F1420 for standby operation. The logic voltage is applied to the J5 header connection as shown in Figure 19.

To place the amplifier in the active mode (on) use one of these options:

- Make no connections on J5
- Apply a logic LOW signal to STBY (pin 2 of J5 or the middle pin).
- Make a connection between pins 1 (GND) and STBY (pin 2 of J5 or the middle pin).

To place the amplifier in the standby mode (off) use one of these options:

- Apply a logic HIGH signal to STBY (pin 2 of J5 or the middle pin).
- Make a connection between pins 3 (VCC) and STBY (pin 2 of J5 or the middle pin).

Figure 19. Standby Pin Connection

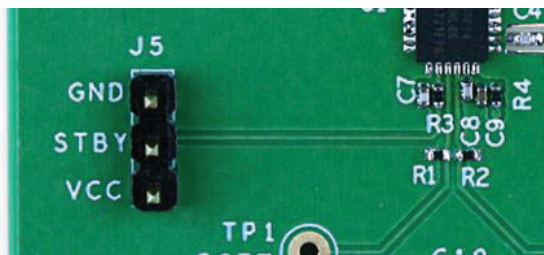

Power-On Procedure

Set up the voltage supplies and Evaluation Board as described in the "Power Supply Setup" section and set the "Standby Pin" or logic LOW.

- Enable the power supply.
- The STBY pin now can now be exercised.

Power-Off Procedure

- Set the STBY pin for logic LOW.
- Disable the power supply.

Application Information

The F1420 has been optimized for use in high performance RF applications from 700MHz to 1100MHz.

Standby Mode (STBY)

The F1420 has a standby pin that allows the amplifier to be turned off to decrease overall power requirements. The pin uses simple logic levels and is compatible with both JECEC 1.8V and JEDEC 3.3V logic. Table 7 lists the amplifier state for the logic. An internal pull-down resistor causes the amplifier to default to the on state.

Table 7. Standby Truth Table

| STBY (pin 8) | Condition |
|--------------|---------------|
| LOW or Open | Amplifier On |
| HIGH | Amplifier Off |

RSET and RDSET

The F1420 has been optimized for gain and intermodulation products by adjusting the bias resistors RSET and RDSET. For the optimized setting, the values are RSET (R1) is 2.26kΩ and RDSET (R2) is 5.76kΩ.

Power Supplies

The power supply pin should be bypassed with external capacitors to minimize noise and fast transients. Supply noise can degrade noise figure and fast transients can trigger ESD clamps and cause them to fail. Supply voltage change or transients should have a slew rate smaller than 1V/20μs.

Control Pin Interface

If control signal integrity is a concern and clean signals cannot be guaranteed due to overshoot, undershoot, ringing, etc., the following circuit at the input of each control pin is recommended. This applies to control pin 8 (STBY). Note the recommended resistor and capacitor values do not necessarily match the EVKit BOM for the case of poor control signal integrity.

Figure 20. Control Pin Interface for Signal Integrity

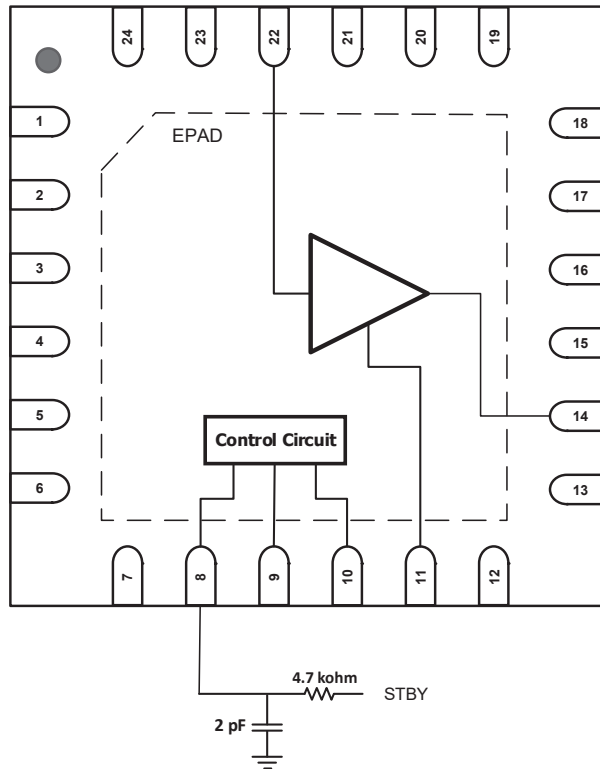

Digital Pin Voltage and Resistance Values

Table 8 provides the open-circuit DC voltage referenced to ground and resistance value for the control pin listed.

Table 8. Digital Pin Voltages and Resistance

| Pin | Name | Open Circuit DC Voltage | Internal Connection |
|-----|------|-------------------------|--------------------------|
| 8 | STBY | 0V | 580kΩ resistor to ground |

Package Outline Drawings

The package outline drawings and land pattern are located at the end of this document. The package information is the most current data available and is subject to change without notice or revision of this document.

Ordering Information

| Orderable Part Number | Package | MSL Rating | Shipping Packaging | Temperature |
|-----------------------|--|------------|--------------------|----------------|
| F1420NLGK | 4mm x 4mm x 0.9mm 24-pin QFN (NLG24P1) | 1 | Tray | -40° to +105°C |
| F1420NLGK8 | 4mm x 4mm x 0.9mm 24-pin QFN (NLG24P1) | 1 | Reel | -40° to +105°C |
| F1420EVBI | Evaluation Board | | | |

Marking Diagram



Line 1 and 2 are the part number.
 Line 3 "ZA" is for die version.
 Line 3 "721" is one digit for the year and week that the part was assembled.
 Line 3 "FTG" denotes the production process.

Revision History

| Revision | Revision Date | Description of Change |
|----------|------------------|----------------------------------|
| 0 | January 23, 2018 | Initial release of the datasheet |

| DATE CREATED | | REVISIONS | | AUTHOR | |
|--------------|---------------------|-----------|---------------------|--------|-------------|
| REV | DESCRIPTION | REV | DESCRIPTION | REV | DESCRIPTION |
| 00 | INITIAL RELEASE | 00 | INITIAL RELEASE | J.H | J.H |
| 01 | ADD CHAMFER ON EPAD | 01 | ADD CHAMFER ON EPAD | J.H | J.H |

REFER TO DCP FOR OFFICIAL RELEASE DATE

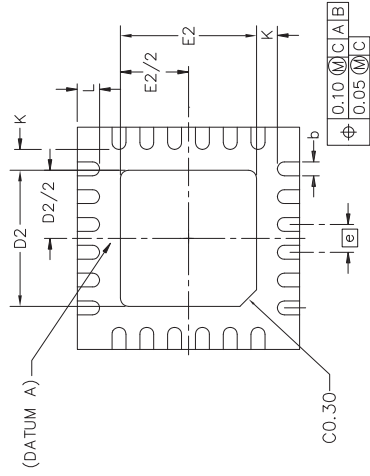
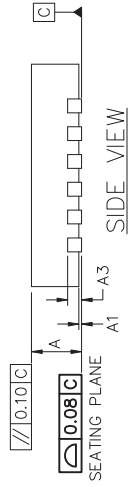
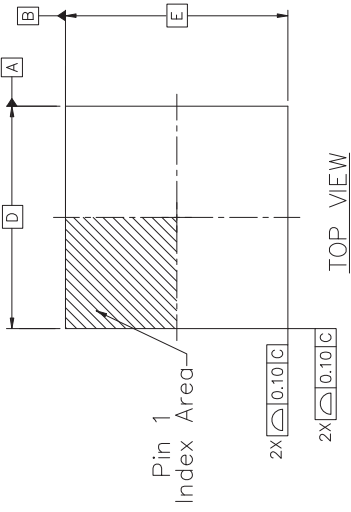

| SYMBOL | DIMENSIONS | | |
|--------|------------|------|------|
| | MIN. | NOM. | MAX. |
| A | 0.80 | 0.90 | 1.00 |
| A1 | 0.00 | 0.02 | 0.05 |
| A3 | 0.20 REF | | |
| K | 0.375 | | |
| D | 4.00 BSC | | |
| E | 4.00 BSC | | |
| D2 | 2.30 | 2.45 | 2.60 |
| E2 | 2.30 | 2.45 | 2.60 |
| e | 0.50 BSC | | |
| L | 0.30 | 0.40 | 0.50 |
| b | 0.18 | 0.25 | 0.30 |

NOTES :

1. DIMENSIONING AND TOLERANCING CONFORME TO ASME Y14.5M - 1994.
2. ALL DIMENSIONS ARE IN MILLIMETERS.

| | |
|--|--|
| TOLERANCES UNLESS SPECIFIED DECIMAL XX± XXX± XXXX± | 6024 Silver Creek Valley Road San Jose, CA 95138 PHONE: (408) 284-8200 FAX: (408) 284-8591 |
| ANGULAR ± | IDT www.IDT.com |
| TITLE NL/NLG24P1 PACKAGE OUTLINE | |
| 4.0 x 4.0 mm BODY 0.5 mm PITCH QFN | |
| SIZE C | DRAWING No. PSC-4192-01 |
| REV C | REV 01 |
| DO NOT SCALE DRAWING SHEET 1 OF 2 | |

| DATE CREATED | | REV | | DESCRIPTION | | AUTHOR | |
|--|--|-----|--|---------------------|--|--------|--|
| 11/17/15 | | 00 | | INITIAL RELEASE | | J.H | |
| 9/9/16 | | 01 | | ADD CHAMFER ON EPAD | | J.H | |
| REFER TO DCP FOR OFFICIAL RELEASE DATE | | | | | | | |

REVISIONS

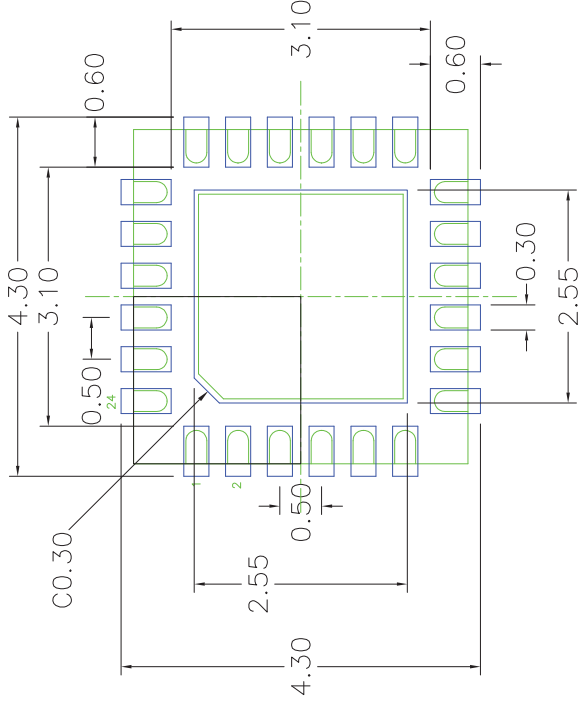

RECOMMENDED LAND PATTERN DIMENSION

NOTES:

1. ALL DIMENSIONS ARE IN mm. ANGLES IN DEGREES.
2. TOP DOWN VIEW, AS VIEWED ON PCB.
3. COMPONENT OUTLINE SHOWS FOR REFERENCE IN GREEN.
4. LAND PATTERN IN BLUE. NSMD PATTERN ASSUMED.
5. LAND PATTERN RECOMMENDATION PER IPC-7351B GENERIC REQUIREMENT FOR SURFACE MOUNT DESIGN AND LAND PATTERN.

| | |
|--|---|
| <p> TOLERANCES UNLESS SPECIFIED DECIMAL ANGULAR XXX± 2 XXX± XXXX± </p> | <p> IDT 6024 Silver Creek Valley Road San Jose, CA 95138 PHONE: (408) 284-8200 FAX: (408) 284-8591 WWW.IDT.COM </p> |
| <p> TITLE NL/NLG24P1 PACKAGE OUTLINE 4.0 x 4.0 mm BODY 0.5 mm PITCH QFN </p> | <p> DRAWING No. PSC-4192-01 </p> |
| <p> SIZE C </p> | <p> REV 01 </p> |
| <p>DO NOT SCALE DRAWING</p> | |
| <p>SHEET 2 OF 2</p> | |

IMPORTANT NOTICE AND DISCLAIMER

RENESAS ELECTRONICS CORPORATION AND ITS SUBSIDIARIES (“RENESAS”) PROVIDES TECHNICAL SPECIFICATIONS AND RELIABILITY DATA (INCLUDING DATASHEETS), DESIGN RESOURCES (INCLUDING REFERENCE DESIGNS), APPLICATION OR OTHER DESIGN ADVICE, WEB TOOLS, SAFETY INFORMATION, AND OTHER RESOURCES “AS IS” AND WITH ALL FAULTS, AND DISCLAIMS ALL WARRANTIES, EXPRESS OR IMPLIED, INCLUDING, WITHOUT LIMITATION, ANY IMPLIED WARRANTIES OF MERCHANTABILITY, FITNESS FOR A PARTICULAR PURPOSE, OR NON-INFRINGEMENT OF THIRD-PARTY INTELLECTUAL PROPERTY RIGHTS.

These resources are intended for developers who are designing with Renesas products. You are solely responsible for (1) selecting the appropriate products for your application, (2) designing, validating, and testing your application, and (3) ensuring your application meets applicable standards, and any other safety, security, or other requirements. These resources are subject to change without notice. Renesas grants you permission to use these resources only to develop an application that uses Renesas products. Other reproduction or use of these resources is strictly prohibited. No license is granted to any other Renesas intellectual property or to any third-party intellectual property. Renesas disclaims responsibility for, and you will fully indemnify Renesas and its representatives against, any claims, damages, costs, losses, or liabilities arising from your use of these resources. Renesas' products are provided only subject to Renesas' Terms and Conditions of Sale or other applicable terms agreed to in writing. No use of any Renesas resources expands or otherwise alters any applicable warranties or warranty disclaimers for these products.

(Disclaimer Rev.1.01 Jan 2024)

Corporate Headquarters

TOYOSU FORESIA, 3-2-24 Toyosu,
Koto-ku, Tokyo 135-0061, Japan
www.renesas.com

Trademarks

Renesas and the Renesas logo are trademarks of Renesas Electronics Corporation. All trademarks and registered trademarks are the property of their respective owners.

Contact Information

For further information on a product, technology, the most up-to-date version of a document, or your nearest sales office, please visit www.renesas.com/contact-us/.