

Description

The F2955 is a high reliability, low insertion loss, 50Ω SP5T absorptive RF switch designed for a multitude of RF applications, including wireless communications. This device covers a broad frequency range from 50MHz to 8000MHz. In addition to providing low insertion loss, the F2955 also delivers excellent linearity and isolation performance while providing a 50Ω termination to the unused RF input ports. The F2955 also includes a patent-pending constant impedance ($K_{|z|}$) feature. $K_{|z|}$ improves system hot switching ruggedness, minimizes LO pulling in VCOs, and reduces phase and amplitude variations in distribution networks. It is also ideal for dynamic switching/selection between two or more amplifiers while avoiding damage to upstream/downstream sensitive devices, such as power amplifiers (PAs) and analog-to-digital converters (ADCs).

The F2955 uses a single positive supply voltage supporting three logic control pins using either 3.3V or 1.8V control logic. Connecting a negative voltage to pin 20 disables the internal negative voltage generator and becomes the negative supply.

Competitive Advantage

The F2955 provides constant impedance in all RF ports during transitions, improving a system's hot-switching ruggedness. The device also supports high-power handling and high isolation, particularly important for DPD receiver use.

- Constant impedance $K_{|z|}$ during switching transition
- RFX to RFC isolation = 49dB at 4GHz
- Insertion loss = 1.1dB at 4GHz
- IIP3: +60.5dBm at 4GHz
- Extended temperature: -40°C to +105°C

Typical Applications

- Base Station 2G, 3G, 4G
- Portable Wireless
- Repeaters and E911 Systems
- Digital Pre-distortion
- Point-to-Point Infrastructure
- Public Safety Infrastructure
- Military Systems, JTRS Radios
- Cable Infrastructure
- Test / ATE Equipment

Features

- Five symmetric, absorptive RF ports
- High isolation: 49dB at 4000MHz
- Low insertion loss: 1.1dB at 4000MHz
- High linearity:
 - IIP2 of 114dBm at 2000MHz
 - IIP3 of 60.5dBm at 4000MHz
- High operating power handling:
 - 33dBm CW on selected RF port
 - 27dBm on terminated ports
- Single 2.7V to 5.5V supply voltage
- External negative supply option
- 3.3V and 1.8V compatible control logic
- Operating temperature: -40°C to +105°C
- 4 × 4 mm 24-QFN package
- Pin compatible with competitors

Block Diagram

Figure 1. Block Diagram

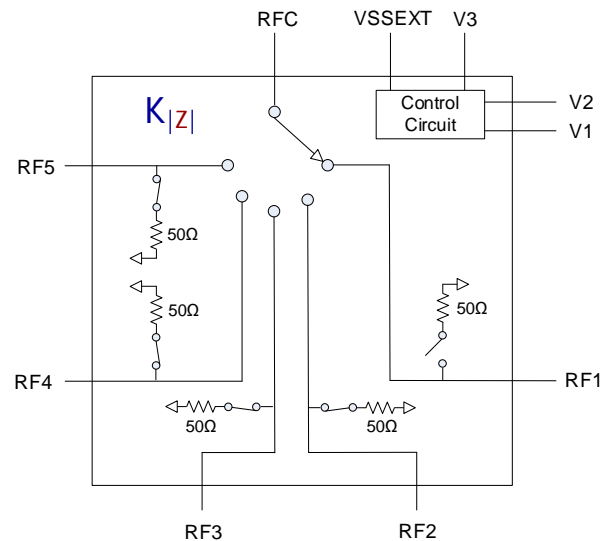

Pin Assignments

Figure 2. Pin Assignments for 4 x 4 x 0.75 mm 24-QFN – Top View

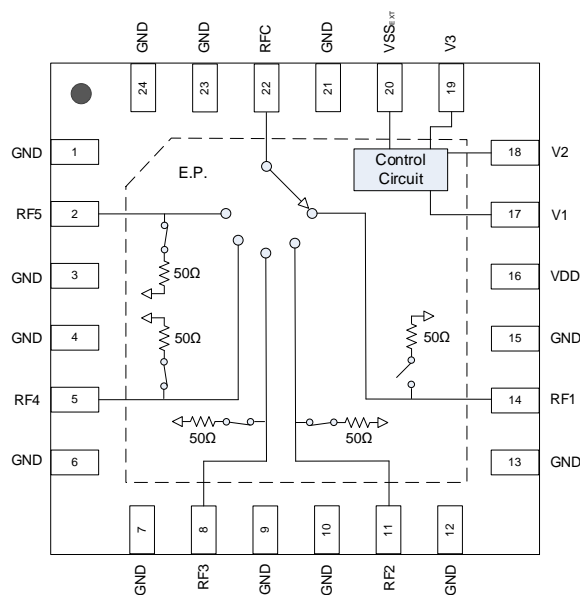

Pin Descriptions

Table 1. Pin Descriptions

Number	Name	Description
1, 3, 4, 6, 7, 9, 10, 12, 13, 15, 21, 23, 24	GND	Ground these pins as close to the device as possible.
2	RF5	RF5 Port. Matched to 50Ω. If this pin is not 0V DC, then an external coupling capacitor must be used.
5	RF4	RF5 Port. Matched to 50Ω. If this pin is not 0V DC, then an external coupling capacitor must be used.
8	RF3	RF5 Port. Matched to 50Ω. If this pin is not 0V DC, then an external coupling capacitor must be used.
11	RF2	RF5 Port. Matched to 50Ω. If this pin is not 0V DC, then an external coupling capacitor must be used.
14	RF1	RF5 Port. Matched to 50Ω. If this pin is not 0V DC, then an external coupling capacitor must be used.
16	V _{DD}	Power Supply. Bypass to GND with capacitors as shown in the “Typical Application Circuit” (Figure 39) as close as possible to the pin.
17	V1	Control pin to set the switch state. See Table 8.
18	V2	Control pin to set the switch state. See Table 8.
19	V3	Control pin to set the switch state. See Table 8.
20	VSS _{EXT}	External VSS negative voltage control. Connect to ground to enable on-chip negative voltage generator. To bypass and disable on chip generator connect this pin to an external VSS.
22	RFC	RF Common Port. Matched to 50Ω when one of the 5 RF ports is selected. If this pin is not 0V DC, then an external coupling capacitor must be used.
	EPAD	Exposed Paddle. Internally connected to GND. Solder this exposed pad to a PCB pad that uses multiple ground vias to provide heat transfer out of the device into the PCB ground planes. These multiple ground vias are also required to achieve the specified RF performance.

Absolute Maximum Ratings

Stresses beyond those listed below may cause permanent damage to the device. Functional operation of the device at these or any other conditions beyond those indicated in the operational section of this specification is not implied. Exposure to absolute maximum rating conditions for extended periods may affect device reliability.

Table 2. Absolute Maximum Ratings

Parameter	Symbol	Minimum	Maximum	Unit
V _{DD} to GND	V _{DD}	-0.3	+5.5	V
V1, V2, V3 to GND	V _{CNTL}	-0.3	Lower of (3.6, V _{DD} +0.3)	V
RF1, RF2, RF3, RF4, RF5, RFC to GND	V _{RF}	-0.3	+0.3	V
V _{SSEXT} to GND	V _{SSEXT}	-4.0	+0.3	V
Input Power for Any One Selected RF Through Port (V _{DD} applied at 2GHz and T _{EPAD} = +85°C)	P _{MAXTHRU}	-	37	dBm
Input Power for Any One Selected RF Terminated Port (V _{DD} applied at 2GHz and T _{EPAD} = +85°C)	P _{MAXTERM}	-	30	dBm
Input Power for RFC When in the All Off State (V _{DD} applied at 2GHz and T _{EPAD} = +85°C)	P _{MAXCOM}	-	33	dBm
Continuous Power Dissipation ^[a] (T _{EPAD} = +95°C Max)	P _{CONT}	-	3	W
Maximum Junction Temperature	T _{JMAX}	-	+125	°C
Storage Temperature Range	T _{ST}	-65	+150	°C
Lead Temperature (soldering, 10s)	T _{LEAD}	-	+260	°C
ESD Voltage – HBM (Per JESD22-A114)	V _{ESDHBM}	-	1500 (Class 1C)	V
ESD Voltage – CDM (Per JESD22-C101)	V _{ESDCDM}	-	1000 (Class C3)	V

[a] T_{EPAD} = Temperature of the exposed paddle

Recommended Operating Conditions

Table 3. Recommended Operating Conditions

Parameter	Symbol	Condition	Minimum	Typical	Maximum	Unit	
Power Supply Voltages	V _{DD}	Pin 20 grounded	2.7	-	5.25	V	
		Pin 20 driven with VSS _{EXT}	2.7	-	5.25		
	VSS _{EXT}	Negative supply [a]	-3.6	-3.4	-3.2		
Operating Temperature Range	T _{EPAD}	Exposed paddle	-40	-	+105	°C	
RF Frequency Range	f _{RF}	-	50	-	8000	MHz	
RF Continuous Input CW Power [b]	P _{RF}	Selected ports	-	-	33	dBm	
		Terminated ports [c]	-	-	27		
RF Continuous Input CW Power for Hot RF Switching [c]	P _{RF_{SW}}	RFC as the input	Switch to RF1 through RF5	-	-	27	dBm
			Switched into or out of all off state	-	-	24	
		RF1 through RF5 as the inputs	Switched to RFC or into term[c]	-	-	27	
			Switch into or out of all off conditions	-	-	27	
RF1 through 5 Port Impedance	Z _{RFx}	-	-	50	-	Ω	
RFC Port Impedance	Z _{RFC}	-	-	50	-		

- [a] For normal operation, connect VSS_{EXT} (pin 20) = 0V to GND to enable the internal negative voltage generator. If VSS_{EXT} is applied to pin 20, the on-chip negative voltage generator is disabled, completely eliminating any generator spurious responses.
- [b] Levels based on T_{EPAD} ≤ 85°C. See Figure 3 for the power de-rating curve for higher case temperatures.
- [c] In any of the insertion loss modes or when switching into any insertion loss mode, any 3 of the 4 remaining terminated port paths can be each exposed to the maximum stated power level during continuous or hot switching operation.

Figure 3. Maximum CW RF Input Operating Power vs. RF Frequency

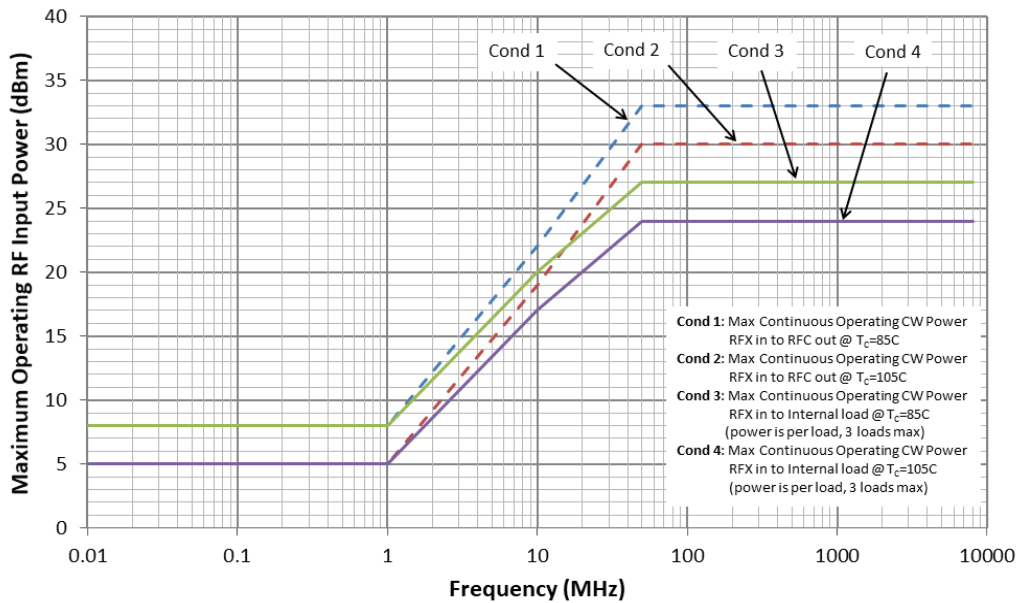

Electrical Characteristics (1)

Table 4. Electrical Characteristics

Typical application circuit (Figure 39), Normal Mode ($V_{DD} = 3.3V$, $V_{SS_{EXT}} = 0V$) or Bypass Mode ($V_{DD} = 3.3V$, $V_{SS_{EXT}} = -3.3V$), $T_{EPAD} = +25^{\circ}C$, $f_{RF} = 2000MHz$, input power = 0dBm, $Z_S = Z_L = 50\Omega$, RFX = one of the five input ports, and PCB board trace and connector losses are embedded unless otherwise noted.

Parameter	Symbol	Condition		Minimum	Typical	Maximum	Unit
Logic Input High	V_{IH}	-		1.1 [a]	-	Lower of (3.6, V_{DD})	V
Logic Input Low	V_{IL}	-		-0.3	-	0.6	V
Logic Current	I_{IH} , I_{IL}	For each control pin		-2	-	+2	μA
V_{DD} DC Current	I_{DD}	Normal Mode	3.3V or 1.8V logic	-	290	360	μA
		Bypass Mode	3.3V or 1.8V logic	-	270	340	
DC Current ($V_{SS_{EXT}}$)	I_{VSS}	$V_{SS_{EXT}} = -3.3V$		-	-46	-60	μA
Insertion Loss RFX to RFC	IL	$f_{RF} = 900MHz$		-	0.93	1.4	dB
		$f_{RF} = 2100MHz$		-	1.1	1.5	
		$f_{RF} = 2700MHz$		-	1.2	1.6	
		$2700MHz < f_{RF} \leq 4000MHz$		-	1.1	1.65	
		$4000MHz < f_{RF} \leq 8000MHz$		-	2.3	-	
Insertion Loss Flatness	IL_{FLAT}	400MHz to 3800MHz Any 400MHz range		-	0.1	0.4	dB
Minimum Isolation RFX to RFC [b][c]	ISOC	$400MHz \leq f_{RF} \leq 900MHz$		57.5	62	-	dB
		$900MHz < f_{RF} \leq 2100MHz$		51	55	-	
		$2100MHz < f_{RF} \leq 2700MHz$		49.5	54	-	
		$2700MHz < f_{RF} \leq 4000MHz$		45	49	-	
		$4500MHz \leq f_{RF} \leq 5500MHz$		43	44.8	-	
Minimum Isolation RFX to RFX [b][d]	ISOX	$400MHz \leq f_{RF} \leq 900MHz$		56.5	59	-	dB
		$900MHz < f_{RF} \leq 2100MHz$		50	53	-	
		$2100MHz < f_{RF} \leq 2700MHz$		48	51	-	
		$2700MHz < f_{RF} \leq 4000MHz$		44.5	48	-	
		$4500MHz \leq f_{RF} \leq 5500MHz$		41	43	-	

[a] Specifications in the minimum/maximum columns that are shown in **bold italics** are guaranteed by test. Specifications in these columns that are not shown in bold italics are guaranteed by design characterization.

[b] With one path always active.

[c] Minimum value specified for RFC to RF1 through RF4 only. Specification does not apply to RF5.

[d] Each of the 4 inputs to any other input, 4 states only, RF5 removed.

Electrical Characteristics (2)

Table 5. Electrical Characteristics

Typical application circuit (Figure 39), Normal Mode ($V_{DD} = 3.3V$, $V_{SS_{EXT}} = 0V$) or Bypass Mode ($V_{DD} = 3.3V$, $V_{SS_{EXT}} = -3.3V$), $T_{EPAD} = +25^{\circ}C$, $f_{RF} = 2000MHz$, input power = 0dBm, $Z_S = Z_L = 50\Omega$, RFX = one of the five input ports, and PCB board trace and connector losses are de-embedded unless otherwise noted.

Parameter	Symbol	Condition	Minimum	Typical	Maximum	Unit
Minimum RFC Return Loss ^[b]	RL _{RFC}	400MHz ≤ f _{RF} ≤ 900MHz	-	23	-	dB
		900MHz < f _{RF} ≤ 2100MHz	-	18	-	
		2100MHz < f _{RF} ≤ 2700MHz	-	16	-	
		2700MHz < f _{RF} ≤ 4000MHz	-	16	-	
		4500MHz ≤ f _{RF} ≤ 5500MHz	-	23	-	
Minimum RFX Return Loss ^[b] (Active Thru)	RL _{RFC_A}	400MHz ≤ f _{RF} ≤ 900MHz	-	23	-	dB
		900MHz < f _{RF} ≤ 2100MHz	-	16	-	
		2100MHz < f _{RF} ≤ 2700MHz	-	15	-	
		2700MHz < f _{RF} ≤ 4000MHz	-	14	-	
		4500MHz ≤ f _{RF} ≤ 5500MHz	-	17	-	
Minimum RFX Return Loss ^[b] (Terminated State)	RL _{RFX_T}	400MHz ≤ f _{RF} ≤ 900MHz	-	30	-	dB
		900MHz < f _{RF} ≤ 2100MHz	-	22	-	
		2100MHz < f _{RF} ≤ 2700MHz	-	20	-	
		2700MHz < f _{RF} ≤ 4000MHz	-	15	-	
		4500MHz ≤ f _{RF} ≤ 5500MHz	-	14	-	
Maximum RFX Port VSWR During Switching	VSWR _T	From RFX Active to RFX Terminated	-	1.7:1	-	
		From RFX Terminated to RFX Active	-	2:1	-	
Input 1dB Compression ^[c]	ICP _{1dB}	-	34 ^[a]	36.5	-	dBm
Input 0.1dB Compression ^[c]	ICP _{0.1dB}	-	28	35	-	dBm
Input IP2 (Insertion Loss State)	IIP2	f _{RF1} = 2000MHz, f _{RF2} = 2010MHz RF input = RFX, P _{IN} = +20dBm / tone f _{RF1} + f _{RF2} = 4010MHz	-	114	-	dBm
		f _{RF1} = 4900MHz, f _{RF2} = 4910MHz RF Input = RFX, P _{IN} = +20dBm / tone f _{RF1} + f _{RF2} = 9810MHz	-	106	-	
		f _{RF1} = 5500MHz, f _{RF2} = 5510MHz RF input = RFX, P _{IN} = +20dBm / tone f _{RF1} + f _{RF2} = 11010MHz	-	111	-	

[a] Specifications in the minimum/maximum columns that are shown in **bold italics** are guaranteed by test. Specifications in these columns that are not shown in bold italics are guaranteed by design characterization.

[b] With one path always active.

[c] The input 0.1dB and 1dB compression points are linearity figures of merit. Refer to the "Absolute Maximum Ratings" section 0 for the maximum RF input power and for maximum operating RF input power.

Electrical Characteristics (3)

Table 6. Electrical Characteristics

Typical application circuit (Figure 39), Normal Mode ($V_{DD} = 3.3V$, $V_{SS_{EXT}} = 0V$) or Bypass Mode ($V_{DD} = 3.3V$, $V_{SS_{EXT}} = -3.3V$), $T_{EPAD} = +25^{\circ}C$, $f_{RF} = 2000MHz$, input power = 0dBm, $Z_S = Z_L = 50\Omega$, RFX = one of the five input ports, and PCB board trace and connector losses are de-embedded unless otherwise noted.

Parameter	Symbol	Condition	Minimum	Typical	Maximum	Unit	
Input IP3	IIP3	$\Delta f = 5MHz$ RF Input = RFX $P_{IN} = +15dBm/$ tone	$f_{RF} = 400MHz$	45 ^[a]	60.5	-	dBm
			$f_{RF} = 2000MHz$	56	60	-	
			$f_{RF} = 4000MHz$	-	60.5	-	
			$f_{RF} = 4900MHz$	-	55	-	
			$f_{RF} = 5500MHz$	-	55	-	
Group Delay	GD	-	-	0.43	1	ns	
Switching Time – Bypass ($V_{SS_{EXT}} = -3.3V$) ^{[b][c]}	t_{BP-ON1}	50% CTRL to 90% maximum RF power	-	256	345	ns	
	t_{BP-ON2}	50% CTRL to RF power settled to within $\pm 0.1dB$ of maximum power	-	285	-		
	t_{BP-OFF}	50% CTRL to 10% maximum RF power	-	256	345		
Switching Time –Normal ($V_{SS_{EXT}} = 0V$) ^{[b][c]}	t_{N-ON1}	50% CTRL to 90% maximum RF power	-	245	-	ns	
	t_{N-ON2}	50% CTRL to RF power settled to within $\pm 0.1dB$ of maximum power	-	295	-		
	t_{N-ON3}	50% CTRL to 99% RF maximum RF power	-	350	-		
	t_{N-OFF1}	50% CTRL to 10% maximum RF power	-	200	-		
	t_{N-OFF2}	50% CTRL to 1% maximum RF power	-	245	-		
Maximum Switching Rate ^[d]		Pin 20 = GND	-	25	-	kHz	
		Pin 20 = $V_{SS_{EXT}}$ applied	-	290	-		
Maximum spurious level on any RF port ^[e]	Spur _{MAX}	RF ports terminated into 50 Ω RFX connected to RFC	-	-120	-	dBm	

[a] Specifications in the minimum/maximum columns that are shown in **bold italics** are guaranteed by test. Specifications in these columns that are not shown in bold italics are guaranteed by design characterization.

[b] $f_{RF} = 1GHz$.

[c] RFC to RFX. In and out of all-off state [000].

[d] Minimum time required between switching of states =1/ (Maximum Switching Rate).

[e] Spurious due to on-chip negative voltage generator. Typical generator fundamental frequency is 2.2MHz.

Thermal Characteristics

Table 7. Package Thermal Characteristics

Parameter	Symbol	Value	Unit
Junction-to-Ambient Thermal Resistance	θ_{JA}	41	°C/W
Junction-to-Case Thermal Resistance (Case is defined as the exposed paddle)	θ_{JC}	6.4	°C/W
Moisture Sensitivity Rating (Per J-STD-020)		MSL1	

Typical Operating Conditions (TOCs)

Unless otherwise noted for the TOC graphs on the following pages, the following conditions apply.

- $V_{DD} = 3.3V$.
- $T_{EPAD} = +25^{\circ}C$ (Temperature of exposed paddle).
- $f_{RF} = 2000MHz$.
- RFX is the driven RF port, and RFC is the output port.
- $P_{IN} = 10dBm$ for all small signal tests.
- $P_{IN} = +15dBm$ / tone applied to selected RFX port for two-tone linearity tests.
- Two-tone frequency spacing = 5MHz.
- $Z_S = Z_L = 50\Omega$.
- All unused RF ports terminated into 50Ω.
- For insertion loss and isolation plots, RF trace and connector losses are de-embedded (see Figure 36 for the “EVKIT Trace and Connector Loss vs. Temperature” plot).
- Plots for isolation and insertion loss over temperature and voltage are for a typical path. For performance of a specific path, refer to the online S-Parameter file.

Typical Performance Characteristics

Figure 4. Insertion Loss vs. Frequency over Selected Switch

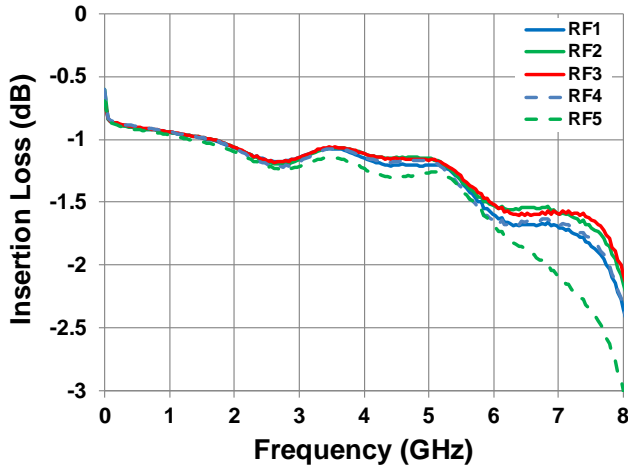

Figure 5. Insertion Loss vs. Frequency over Temperature

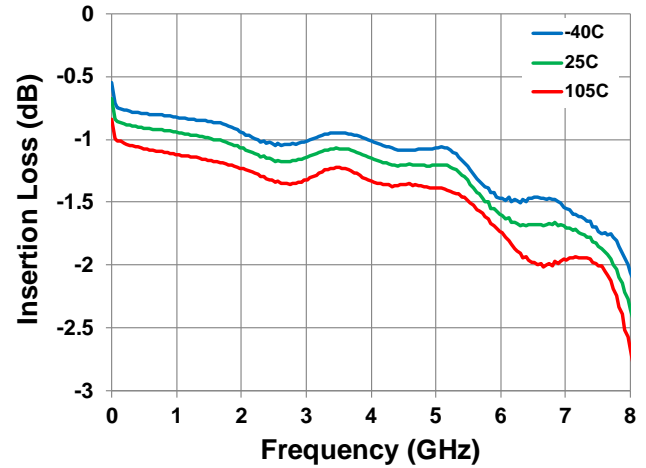

Figure 6. Insertion Loss vs. Frequency over Voltage

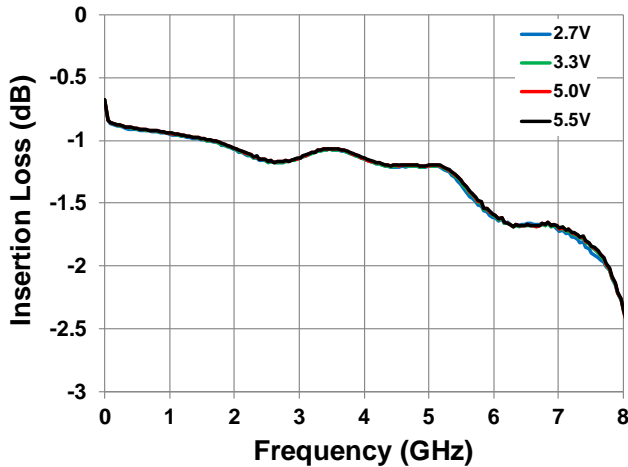

Figure 7. RFC to RFX Isolation vs. Frequency

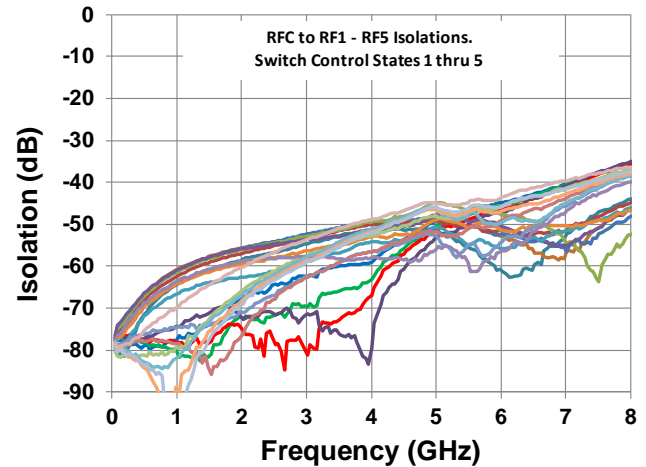

Figure 8. RFC to RFX Isolation vs. Frequency

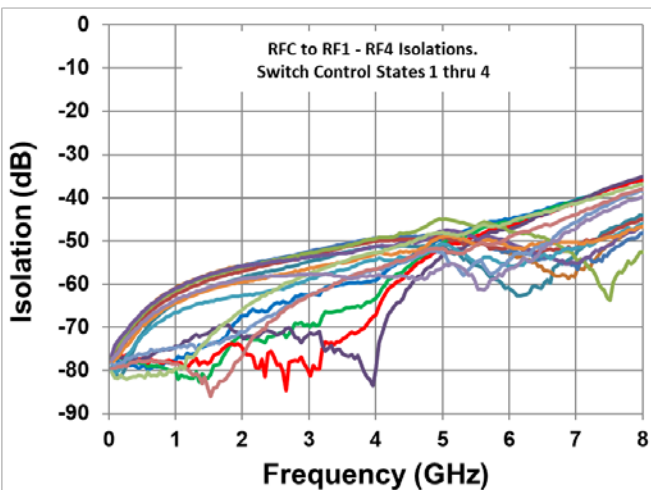

Figure 9. Typical RFC to RFX Isolation vs. Frequency over Temperature

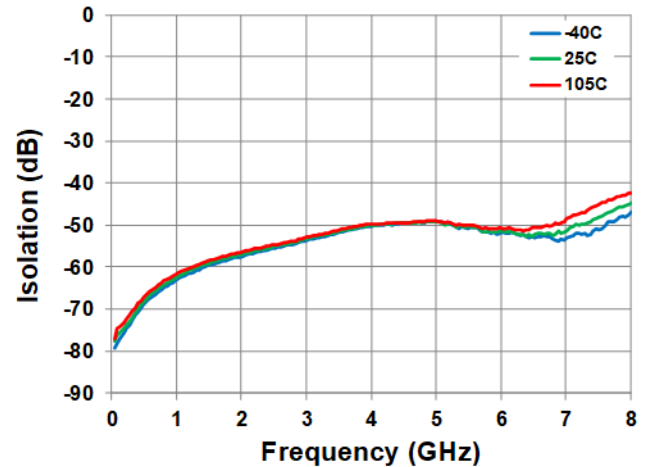

Figure 10. Typical RFC to RFX Isolation vs. Frequency over V_{DD}

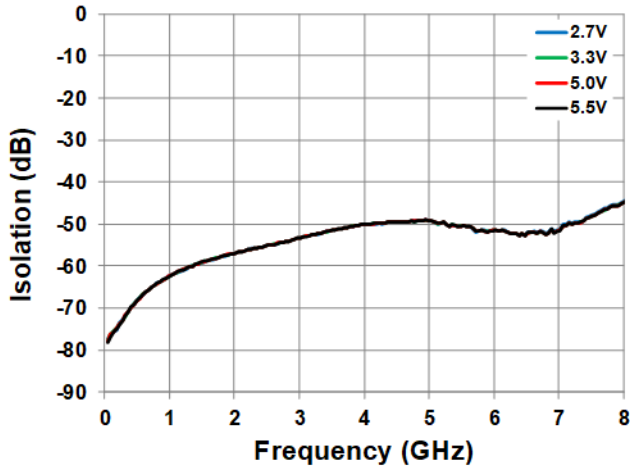

Figure 11. RFX to RFX Isolation vs. Frequency

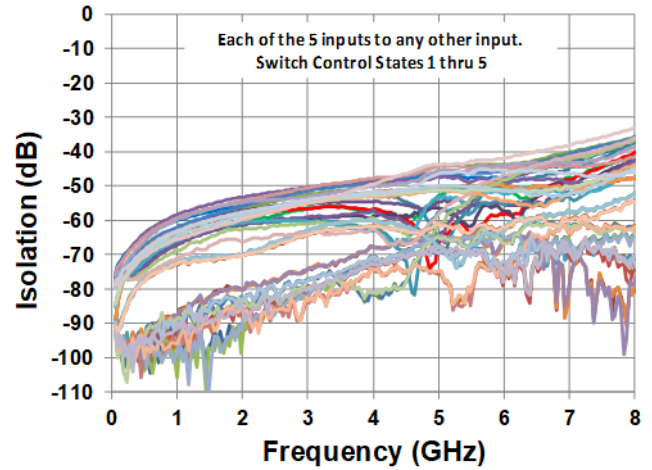

Figure 12. RFX to RFX Isolation vs. Frequency

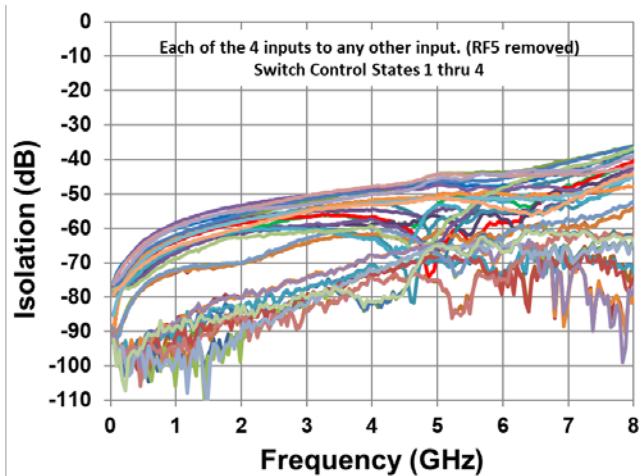

Figure 13. Typical RFX to RFX Isolation vs. Frequency over Temperature

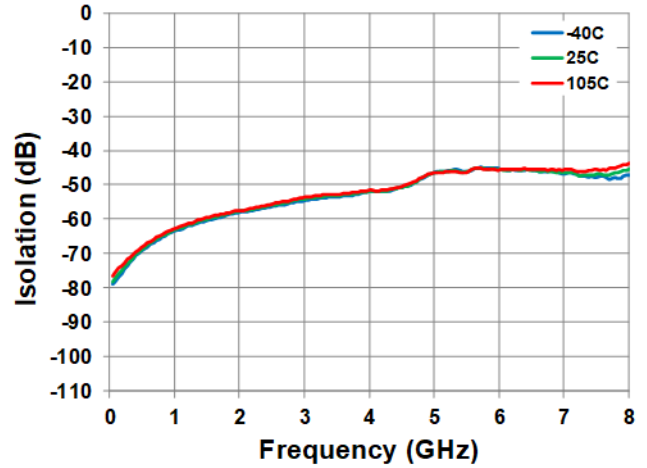

Figure 14. Typical RFX to RFX Isolation vs. Frequency over V_{DD}

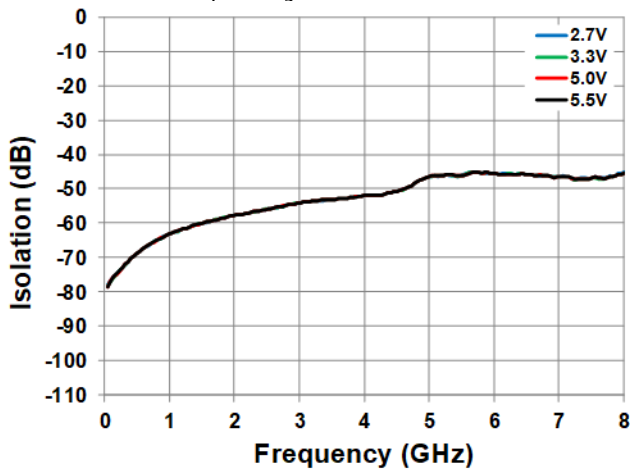

Figure 15. RFX Return Loss vs. Frequency over Switch Path [Selected State]

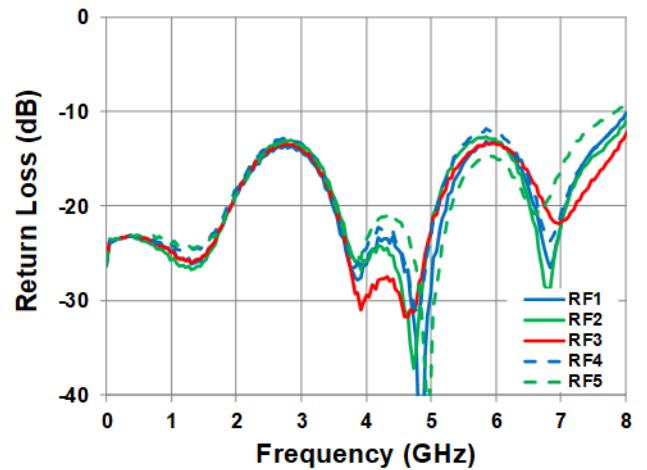

Figure 16. Typical RFX Return Loss vs. Freq. over Temp. [Selected State]

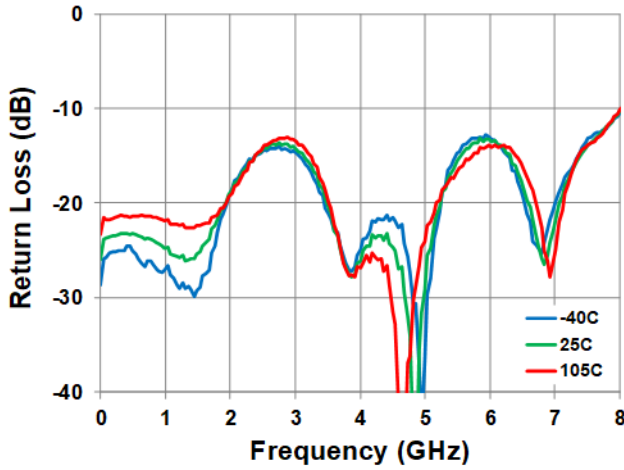

Figure 17. Typical RFX Return Loss vs. Frequency over V_{DD} [Selected State]

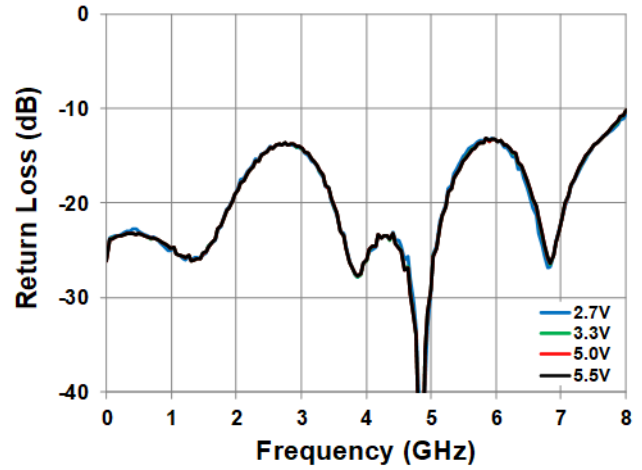

Figure 18. RFC Return Loss vs. Frequency over Switch Path [Selected State]

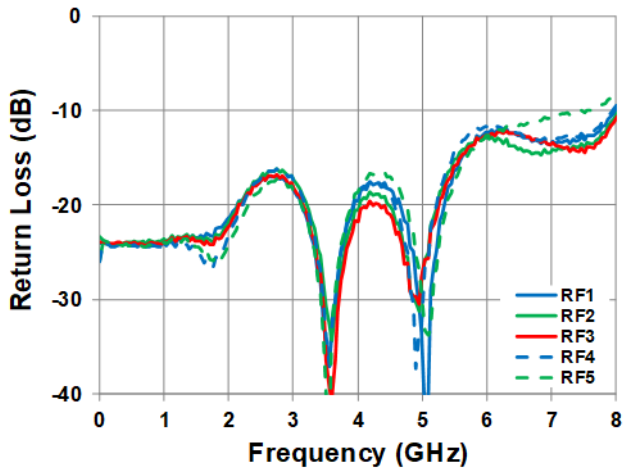

Figure 19. Typical RFC Return Loss vs. Freq. over Temp. [Selected State]

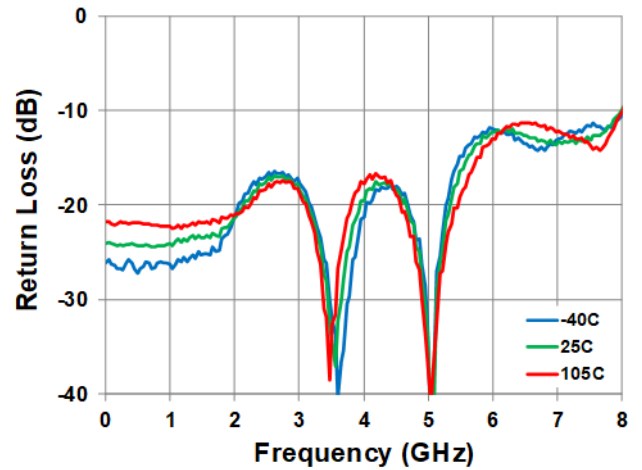

Figure 20. Typical RFC Return Loss vs. Freq. over V_{DD} [Selected State]

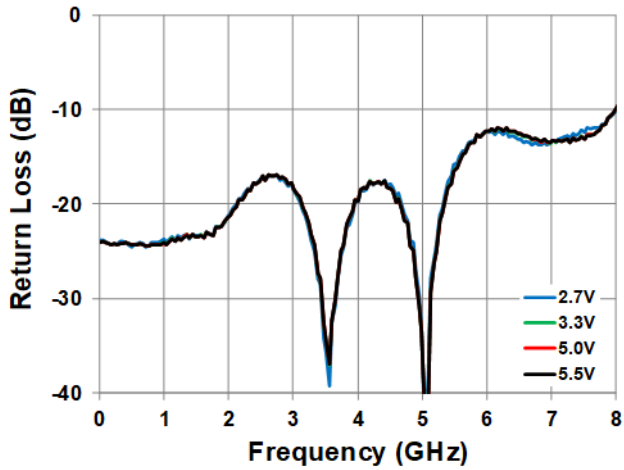

Figure 21. RFX Return Loss vs. Frequency over Switch Path [Terminated State]

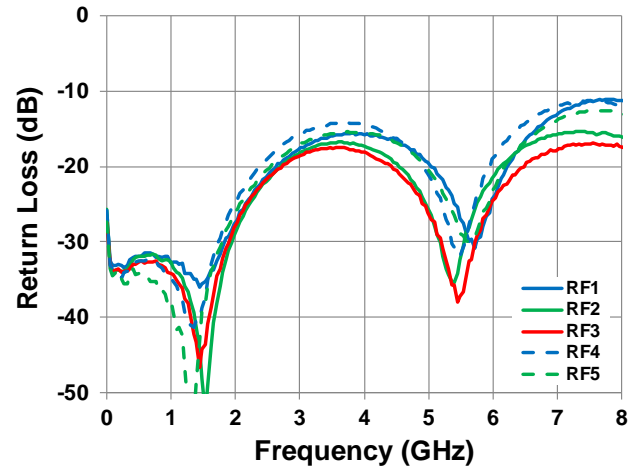

Figure 22. Typical RFX Return Loss vs. Freq. over Temp. [Terminated State]

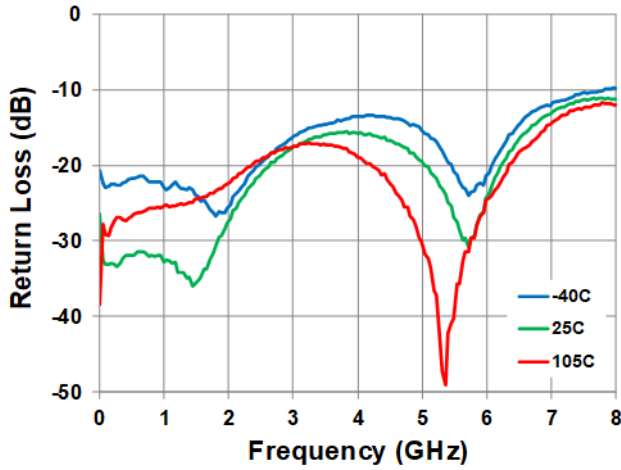

Figure 23. Typical RFX Return Loss vs. Freq. over V_{DD} [Terminated State]

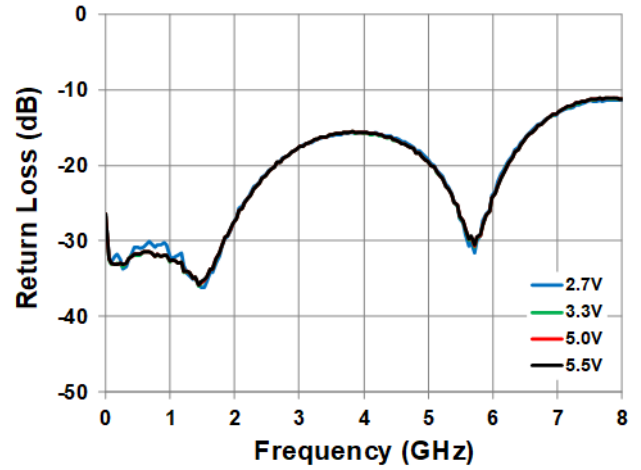

Figure 24. Return Loss (During Switching) vs. Time

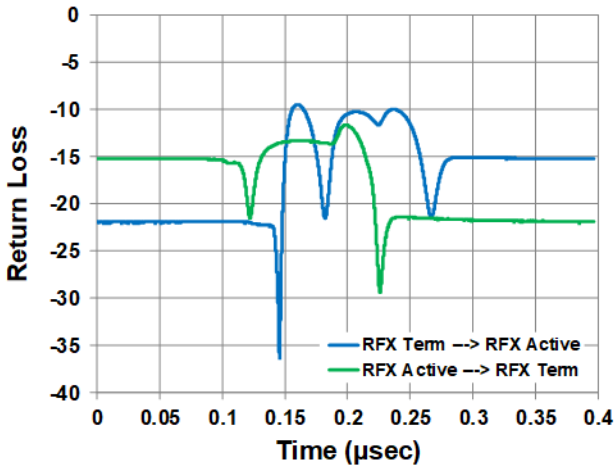

Figure 25. VSWR (During Switching) vs. Time

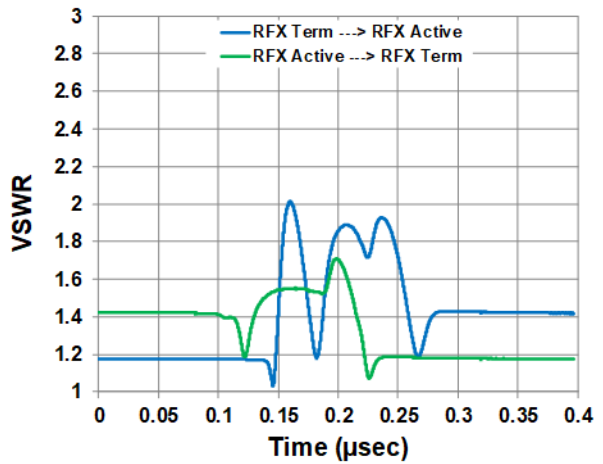

Figure 26. RFX Switching Time [RFX Terminated to RFX Active]

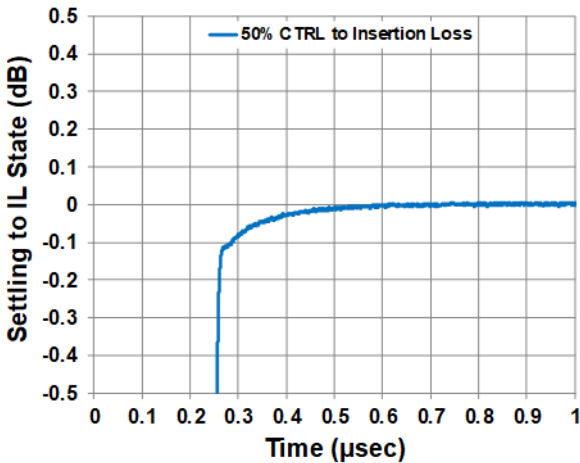

Figure 27. RFX Switching Time [RFX Active to RFX Terminated]

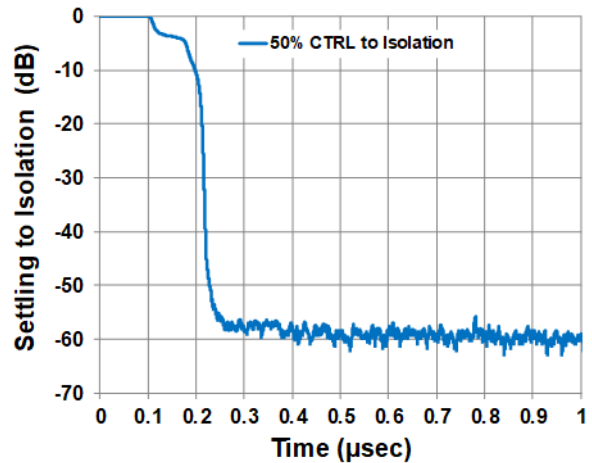

Figure 28. Switching Speed RFX to RFC All Off to On

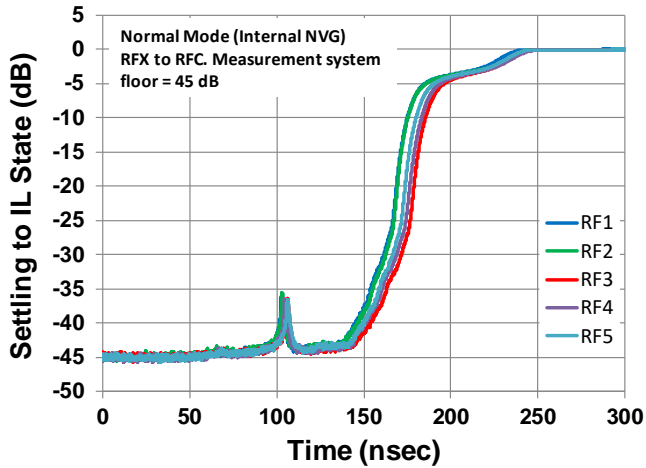

Figure 29. Switching Speed RFX to RFC On to All Off

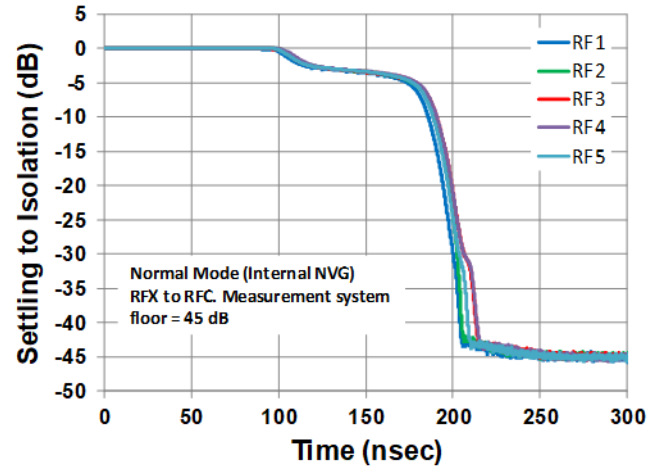

Figure 30. RFX IIP3 vs. Frequency over Switch Path [Selected State]

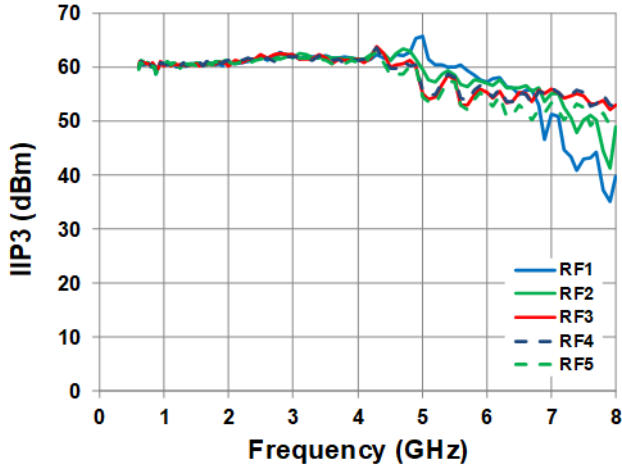

Figure 31. RF1 IIP3 vs. Frequency over Temperature and Voltage

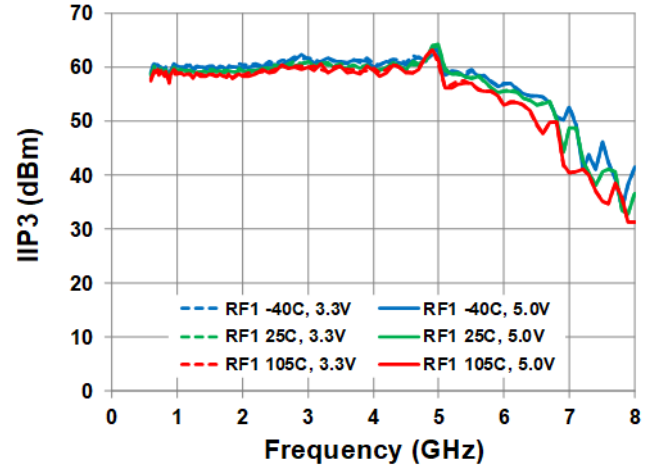

Figure 32. RF2 IIP3 vs. Frequency over Temperature and Voltage

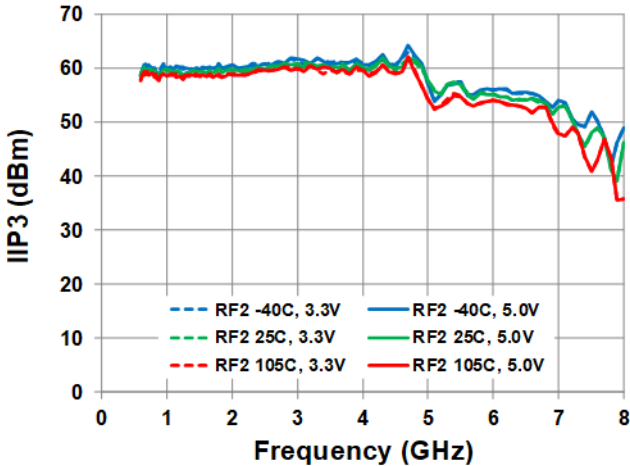

Figure 33. RF3 IIP3 vs. Frequency over Temperature and Voltage

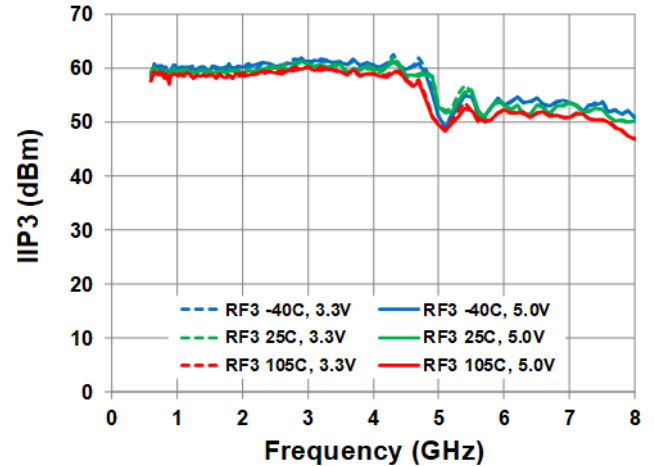

Figure 34. RF4 IIP3 vs. Frequency over Temperature and Voltage

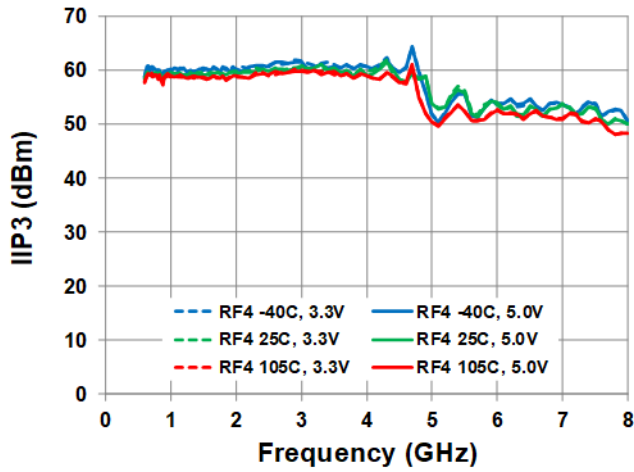

Figure 35. RF5 IIP3 vs. Frequency over Temperature and Voltage

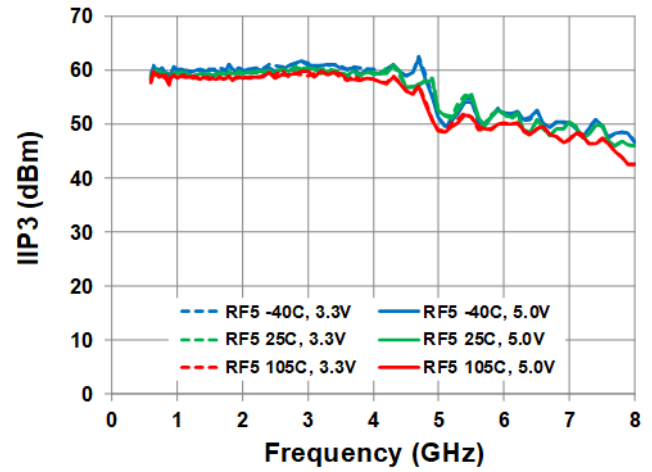
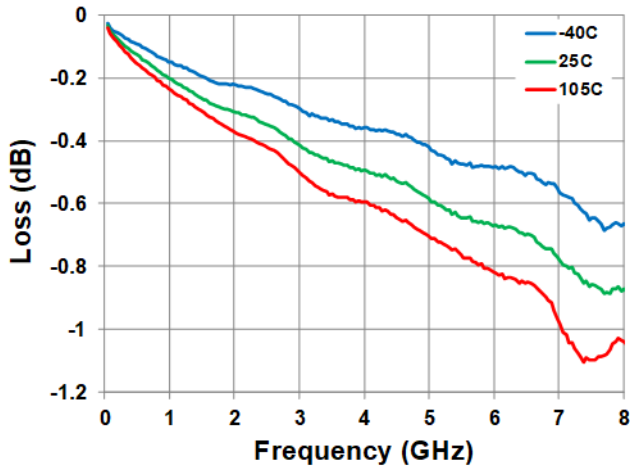

Figure 36. EVKIT Trace and Connector Loss vs. Temperature



Control Mode

To select the path of the F2915 use Table 8 to see the control voltage with either 1.8V or 3.3V logic.

Table 8. Switch Control Truth Table

Mode	V3	V2	V1
All Off	0	0	0
RF1 On	0	0	1
RF2 On	0	1	0
RF3 On	0	1	1
RF4 On	1	0	0
RF5 On	1	0	1
All Off	1	1	0
All Off	1	1	1

Evaluation Kit / Applications Circuit

Figure 39. Electrical Schematic

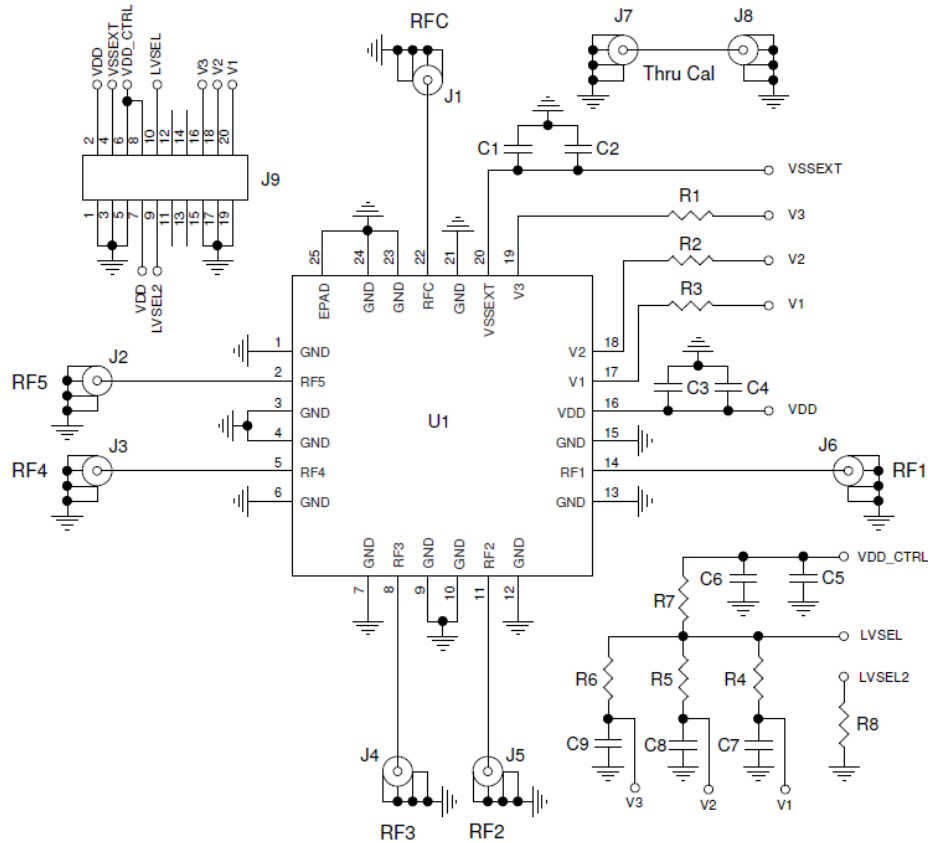

Table 9. Bill of Material (BOM)

Part Reference	QTY	Description	Manufacturer Part #	Manufacturer
C1, C3, C5, C7, C8, C9	6	100pF ±5%, 50V, COG Ceramic Capacitor (0402)	GRM1555C1H101J	Murata
C2	0	Not Installed (0603)	-	-
C4	0	Not Installed (0603)	-	-
C6	1	1000pF ±5%, 50V, COG Ceramic Capacitor (0603)	GRM1885C1H102J	Murata
R1, R2, R3	3	0Ω ±1%, 1/10W, Resistor (0402)	ERJ-2GE0R00X	Panasonic
R4, R5, R6	3	100kΩ ±1%, 1/10W, Resistor (0402)	ERJ-2RKF1003X	Panasonic
R7	1	15kΩ ±1%, 1/10W, Resistor (0402)	ERJ-2RKF1502X	Panasonic
R8	1	22kΩ ±1%, 1/10W, Resistor (0402)	ERJ-2RKF2202X	Panasonic
J1-J8	8	Edge Launch SMA (0.375 inch pitch ground tabs)	142-0701-851	Emerson Johnson
J9	1	CONN HEADER VERT DBL 10 X 2 POS GOLD	67997-120HLF	FCI
U1	1	SP5T Switch 4mm x 4mm QFN24-EP	F2955NBGK	Renesas (IDT)
	1	Printed Circuit Board	F29XX EVKIT Rev 02.0	Renesas (IDT)

Evaluation Kit (EVKit) Operation

External Supply Setup

1. Set up a VDD power supply in the voltage range of 2.7V to 5.5V and disable the power supply output.
2. If using the on-chip negative voltage generator, install a 2-pin shunt to short pins 3 (GND) and 4 (VSSEXT) of J9.
3. If an external negative voltage supply is to be used, set its voltage within the range of -3.6V to -3.2V and disable it. Also, ensure there are no jumper connections on pins 3 and 4 of J9.

Logic Control Setup

Using the EVKIT to Manually Set the Control Logic

1. On connector J9, connect a 2-pin shunt from pin 7 (VDD) to pin 8 (VDD_CTRL). This connection provides the VDD voltage supply to the Evaluation Board logic control pull-up network.
2. On connector J9 connect a 2-pin shunt from pin 9 (LVSEL2) to pin 10 (LVSEL). This connection enables R7 (15k Ω) and R8 (22k Ω) to form a voltage divider to set the proper logic control levels to support the full voltage range of VDD. Note that when using the on-board R7 / R8 voltage divider, the current draw from the VDD supply will be higher by approximately VDD/37k Ω .
3. Connector J9 has 3 logic input pins: V1 (pin 20), V2 (pin 18), and V3 (pin 16). See Table 8 for the logic truth table. With the pull-up network enabled (as noted above), if these pins are left open, a logic HIGH will be provided through pull-up resistors R4, R5, and R6. To set a logic LOW to V1, V2, and V3, connect 2-pin shunts from pin 16 to pin 15, pin 18 to pin 17 and pin 20 to pin 19, respectively.

Using the External Control Logic

Pins 6, 7, 8, 9, and 10 of J9 should have no connection. External logic controls can be applied to J9 pins 16 (V3), 18 (V2) and 20 (V1). See Table 8 for the logic truth table.

Turn On Procedure

1. Set up the supplies and Evaluation Board as noted in "External Supply Setup" and "Logic Control Setup" above.
2. Connect the preset disabled VDD power supply to pin 2 (VDD) and pin 1 (GND) of J9.
3. If the external negative voltage source is to be used, connect the disabled supply to pin 4 (VSSEXT) and pin 3 (GND) of J9. If using the on-chip negative supply, ensure that the 2-pin shunt is installed connecting pin 3 to pin 4.
4. Enable the VDD supply and then enable the VSSEXT supply (if used).
5. Set the desired logic setting using V1, V2, and V3 to achieve the desired path setting, see Table 8. Note that external control logic should not be applied without VDD being applied first.

Turn Off Procedure

1. If using external control logic, V1, V2, and V3 must be set to a logic LOW.
2. Disable any external VSSEXT supply.
3. Disable the VDD supply.

Application Information

Default Start-up

There are no internal pull-up or pull-down resistors on the control pins.

Logic Control

Control pins V1, V2, and V3 are used to set the state of the SP5T switch (See Table 8).

External V_{SS}

The F2955 is designed with an on-chip negative voltage generator. This on-chip generator is enabled by connecting pin 20 of the device to ground. To disable the on-chip generator, apply a negative voltage to pin 20 ($V_{SS_{EXT}}$) of the device within the range stated in the "Recommended Operating Conditions" (Table 3).

Power Supplies

A common VDD power supply should be used for all pins requiring DC power. All supply pins should be bypassed with external capacitors to minimize noise and fast transients. Supply noise can degrade the noise figure, and fast transients can trigger ESD clamps and cause them to fail. Supply voltage change or transients should have a slew rate smaller than $1V / 20\mu s$. In addition, all control pins should remain at 0V ($\pm 0.3V$) while the supply voltage ramps or while it returns to zero.

Control Pin Interface

If control signal integrity is a concern and clean signals cannot be guaranteed due to overshoot, undershoot, ringing, etc., the following circuit at the input of each control pin is recommended. This applies to control pins 17, 18, and 19 as shown below.

Figure 40. Control Pin Interface Schematic

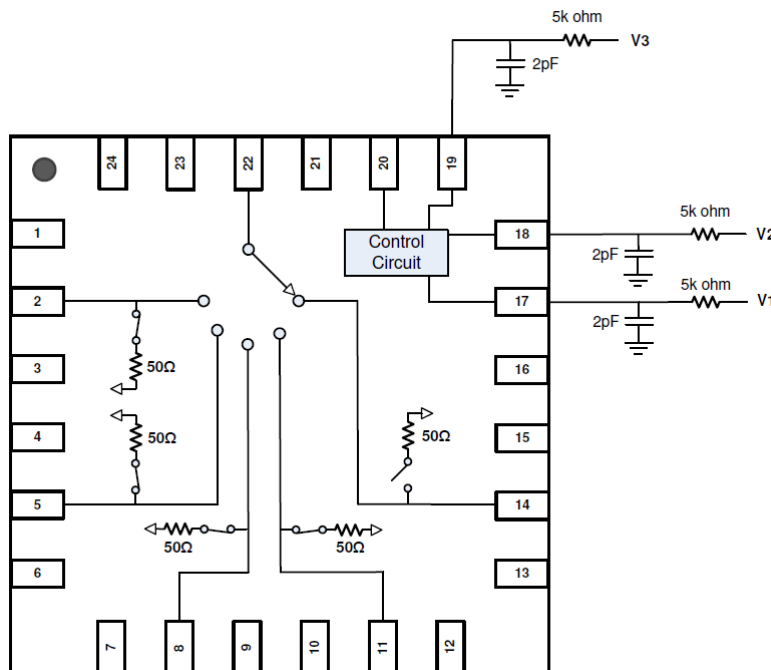

Package Outline Drawings

The package outline drawings are located at the end of this document and are accessible from the Renesas website (see Ordering Information for POD links). The package information is the most current data available and is subject to change without revision of this document.

Marking Diagram

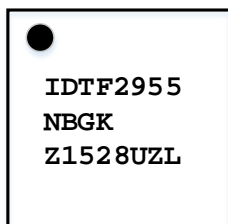

Line 1 and 2 are the part number.
 Line 3: "Z" is for the ASM Test Step.
 Line 3: "1528" is the last two digits of the year plus the work week (YYWW).
 Line 3: "UZL" denotes the Assembler Code.

Ordering Information

Part Number	Package	MSL Rating	Carrier Type	Temperature Range
F2955NBGK	4.0 × 4.0 × 0.75 mm 24-QFN	MSL1	Tray	-40°C to +105°C
F2955NBGK8	4.0 × 4.0 × 0.75 mm 24-QFN	MSL1	Reel	-40°C to +105°C
F2955EVBK	Evaluation Board			

Revision History

Date	Description of Change
November 1, 2023	<ul style="list-style-type: none"> ▪ Updated Block Diagram ▪ Updated Package Outline Drawings section and added POD links in Ordering Information
February 7, 2023	Updated disclaimer and POD links.
June 25, 2020	<ul style="list-style-type: none"> ▪ Rebranded the document as Renesas
February 21, 2019	<ul style="list-style-type: none"> ▪ Corrected HBM ESD voltage in Table 2
October 11, 2018	<ul style="list-style-type: none"> ▪ Changed maximum value for "Maximum Junction Temperature" in Table 2 ▪ Changed maximum value for "VDD to GND" in Table 2 ▪ Updated maximum value for "Power Supply Voltages" in Table 3
September 25, 2018	Initial release.

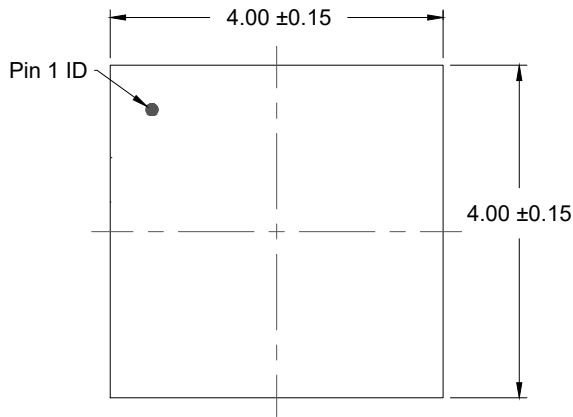

TOP VIEW

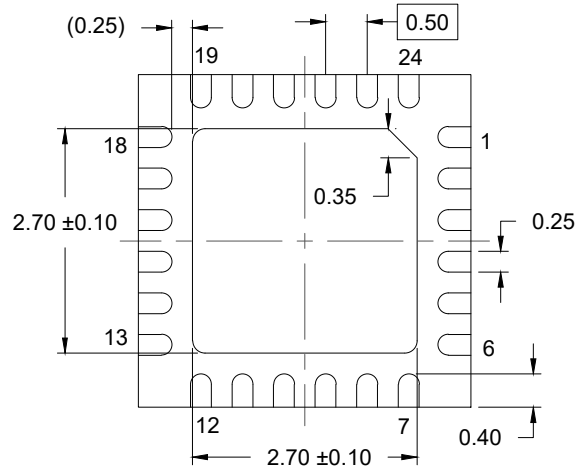

BOTTOM VIEW

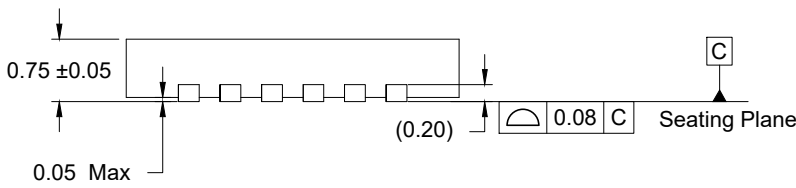

SIDE VIEW

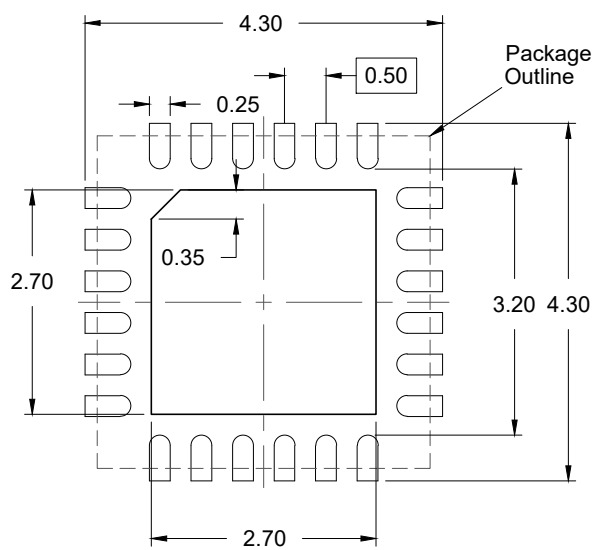

RECOMMENDED LAND PATTERN
 (PCB Top View, NSMD Design)

NOTES:

1. JEDEC compatible.
2. All dimensions are in mm and angles are in degrees.
3. Use ± 0.05 mm for the non-toleranced dimensions.
4. Numbers in () are for references only.

IMPORTANT NOTICE AND DISCLAIMER

RENESAS ELECTRONICS CORPORATION AND ITS SUBSIDIARIES (“RENESAS”) PROVIDES TECHNICAL SPECIFICATIONS AND RELIABILITY DATA (INCLUDING DATASHEETS), DESIGN RESOURCES (INCLUDING REFERENCE DESIGNS), APPLICATION OR OTHER DESIGN ADVICE, WEB TOOLS, SAFETY INFORMATION, AND OTHER RESOURCES “AS IS” AND WITH ALL FAULTS, AND DISCLAIMS ALL WARRANTIES, EXPRESS OR IMPLIED, INCLUDING, WITHOUT LIMITATION, ANY IMPLIED WARRANTIES OF MERCHANTABILITY, FITNESS FOR A PARTICULAR PURPOSE, OR NON-INFRINGEMENT OF THIRD-PARTY INTELLECTUAL PROPERTY RIGHTS.

These resources are intended for developers who are designing with Renesas products. You are solely responsible for (1) selecting the appropriate products for your application, (2) designing, validating, and testing your application, and (3) ensuring your application meets applicable standards, and any other safety, security, or other requirements. These resources are subject to change without notice. Renesas grants you permission to use these resources only to develop an application that uses Renesas products. Other reproduction or use of these resources is strictly prohibited. No license is granted to any other Renesas intellectual property or to any third-party intellectual property. Renesas disclaims responsibility for, and you will fully indemnify Renesas and its representatives against, any claims, damages, costs, losses, or liabilities arising from your use of these resources. Renesas' products are provided only subject to Renesas' Terms and Conditions of Sale or other applicable terms agreed to in writing. No use of any Renesas resources expands or otherwise alters any applicable warranties or warranty disclaimers for these products.

(Disclaimer Rev.1.01 Jan 2024)

Corporate Headquarters

TOYOSU FORESIA, 3-2-24 Toyosu,
Koto-ku, Tokyo 135-0061, Japan
www.renesas.com

Trademarks

Renesas and the Renesas logo are trademarks of Renesas Electronics Corporation. All trademarks and registered trademarks are the property of their respective owners.

Contact Information

For further information on a product, technology, the most up-to-date version of a document, or your nearest sales office, please visit www.renesas.com/contact-us/.