

RAA211403, RAA211405

40V, 300mA, 4µA I_Q DC/DC Step-Down Regulator

The RAA211403 and RAA211405 are tiny, easy-to-use, ultra-low quiescent current (I_Q) buck regulators with a wide input voltage range of 7V to 40V and up to 300mA output current. RAA211403 has a fixed output voltage of 3.3V, and the RAA211405 output voltage is 5V.

The devices offer comprehensive protections, including V_{IN} UVLO, V_{OUT} OVP, overcurrent, and over-temperature protections.

The devices are offered in a TSOT23-5 package.

Applications

- General purpose or LDO replacement
- Industrial power supplies
- Embedded systems and I/O supplies
- E-Bikes, Power tools
- Home/Industrial Automation

Features

- 7V to 40V input supply range
- Up to 300mA output current
- I_Q = 4µA at 40V, at no load conditions, switching
- I_Q = 2.5µA at 40V at no load and no switching conditions
- RAA211403 is fixed 3.3V V_{OUT}, RAA211405 is fixed 5V V_{OUT}
- Minimum on-time of 75ns
- Variable frequency operation, frequency programmed by external inductor (4.7µH to 15µH)
- Pre-bias, monotonic, and smooth start-up
- Protections: Overcurrent (OC) Limit, input Undervoltage Lockout (UVLO), Over-Temperature Protection (OTP), output Overvoltage Protection (OVP)
- Accurate EN threshold
- Package: TSOT23-5 (2.9mm×1.63mm)

Programmable Feature

- Inductor: Change switching frequency
- Enable: Turn on/off with external logic or connect EN to V_{IN}

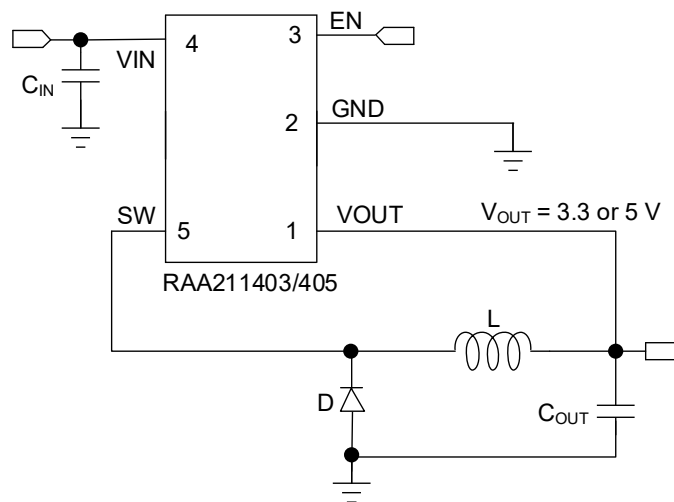

Figure 1. Typical Application Circuit

Contents

1. Overview	3
1.1 Block Diagram	3
1.2 Typical Applications	4
2. Pin Information	6
2.1 Pin Assignments	6
2.2 Pin Descriptions	6
3. Specifications	7
3.1 Absolute Maximum Ratings	7
3.2 Recommended Operating Conditions	7
3.3 Thermal Specifications	7
3.4 Electrical Specifications	8
4. Typical Performance Graphs	9
5. Functional Description	15
5.1 Peak Current and Propagation Delay	15
5.2 Soft-Start	16
5.3 Undervoltage Lockout	17
5.4 Enable Control	18
5.5 Overcurrent Protection (OCP)	19
5.6 Short Circuit	19
5.7 V_{OUT} Overvoltage Protection (OVP)	19
5.8 Pre-Biased Output Voltage	19
5.9 Over-Temperature Protection (OTP)	19
5.10 Switching Frequency	20
5.11 Thermal Derating	21
5.12 Fault Summary	21
6. Component Selection	22
6.1 Input Capacitor	22
6.2 Output Capacitor	22
6.3 Inductor	22
6.4 Diode	22
7. Layout Guidelines	23
8. Package Outline Drawing	24
9. Ordering Information	25
10. Revision History	25

1. Overview

1.1 Block Diagram

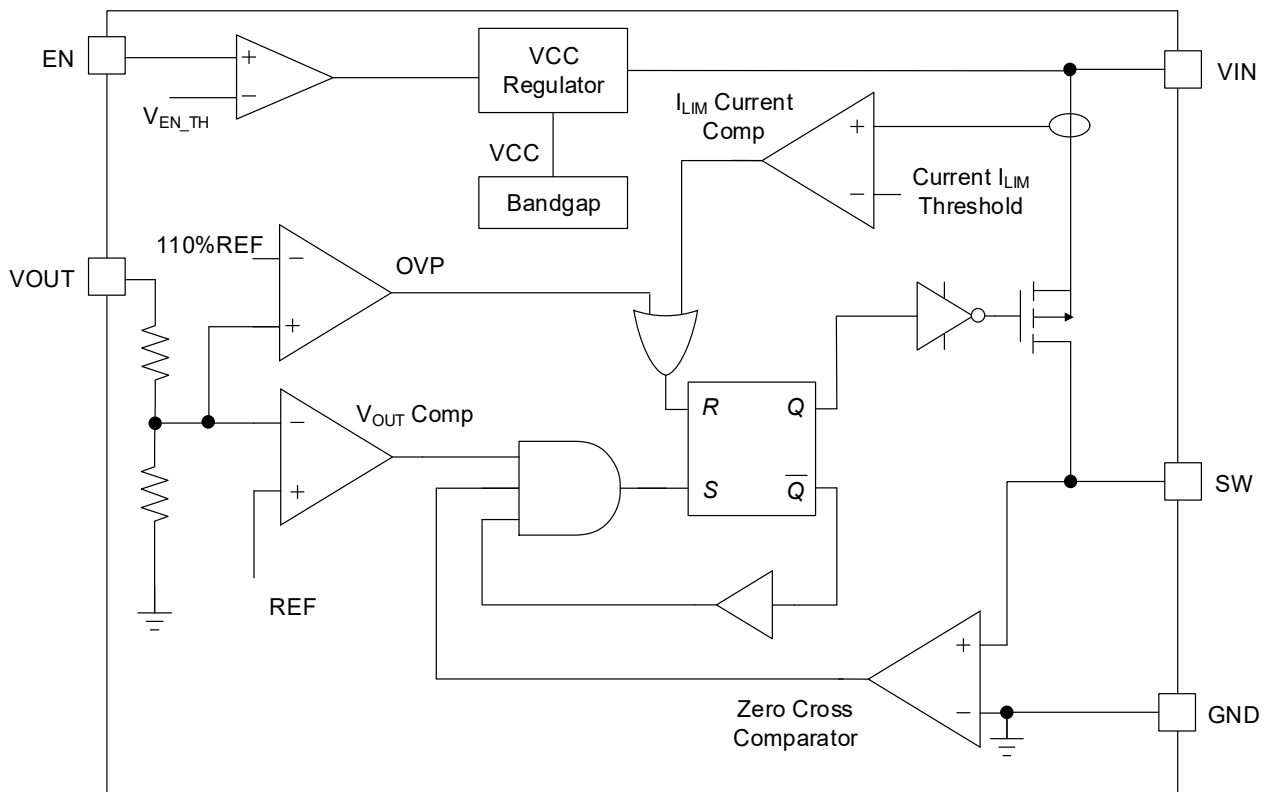

Figure 2. Block Diagram

1.2 Typical Applications

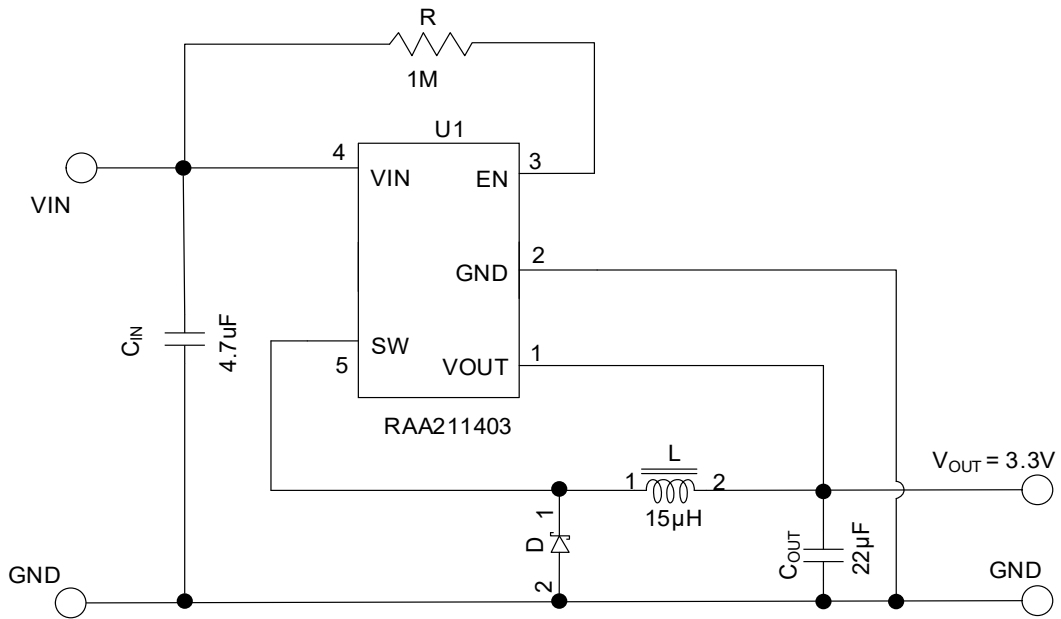

Figure 3. Typical Application Circuit (RAA211403)

Table 1. Typical BOM for RAA211403

Reference Designator	Description	Manufacturer	Manufacturer Part Number
L	COIL-PWR Inductor, SMD, 3mm, 15µH, 20%, 1.71A, 720mΩ DCR, WW, ROHS	Würth	74438335150
C _{IN}	Multilayer Cap, SMD, 0805, 4.7µF, 10%, 50V	Samsung	CL21A475KBQNNNE
R	Thick Film Chip Resistor, SMD, 0603, 1M, 1%, 1/10W	Generic	Various
D	1A 60V Low Vf Schottky Barrier Rectifier, SOD323F	Panjit	MBR1060HEWS_R1_00001
C _{OUT}	Multilayer Cap, SMD, 0603, 22µF, 20%, 10V	Generic	Various

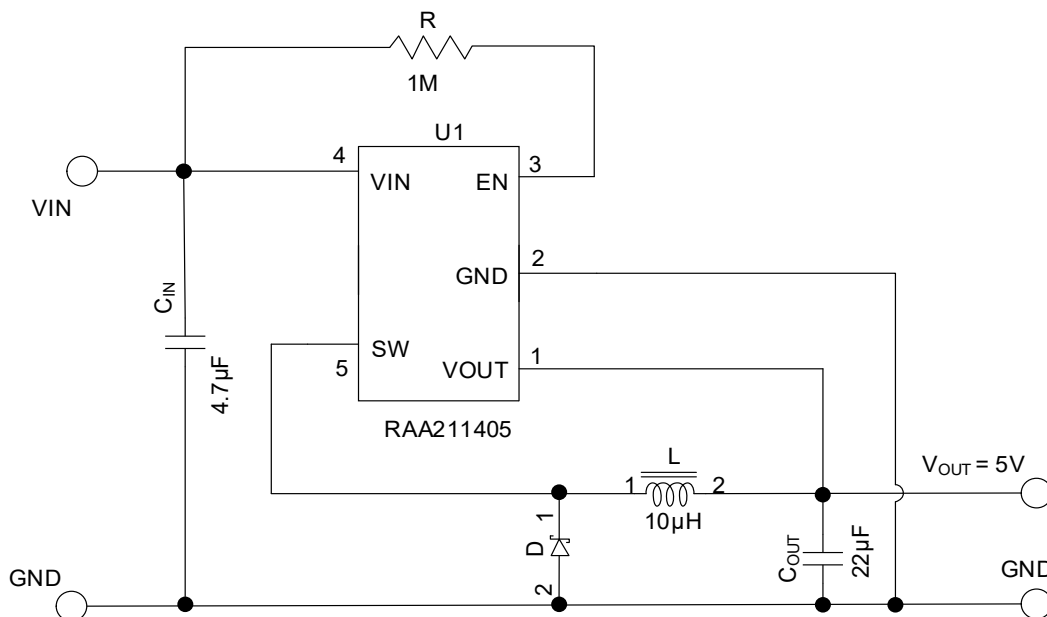

Figure 4. Typical Application Circuit (RAA211405)

Table 2. Typical BOM for RAA211405

Reference Designator	Description	Manufacturer	Manufacturer Part Number
L	COIL-PWR Inductor, SMD, 3mm, 10µH, 20%, 2A, 446mΩ DCR, WW, ROHS	Wurth	74438335100
C _{IN}	Multilayer Cap, SMD, 0805, 4.7µF, 10%, 50V	Samsung	CL21A475KBQNNNE
R	Thick Film Chip Resistor, SMD, 0603, 1M, 1%, 1/10W	Generic	Various
D	1A 60V Low Vf Schottky Barrier Rectifier, SOD323F	Panjit	MBR1060HEWS_R1_00001
C _{OUT}	Multilayer Cap, SMD, 0805, 22µF, 20%, 16V	Generic	Various

2. Pin Information

2.1 Pin Assignments

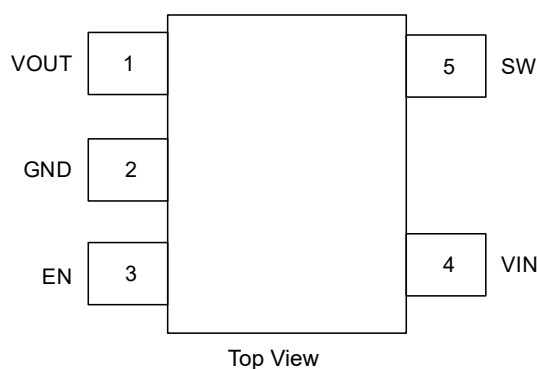

2.2 Pin Descriptions

Pin Number	Pin Name	Description
1	VOUT	Connect this pin to the output voltage of the regulator. This pin is also the bias supply for the IC after the device starts up and is in regulation.
2	GND	Ground connection pin.
3	EN	The enable pin is high voltage tolerant and, therefore, can be directly connected to VIN or a logic voltage for enable and disable. Do not leave this pin floating.
4	VIN	The voltage input for the IC. The VIN pin is connected to the integrated MOSFET source and to a suitable voltage source within the IC operation range of this pin.
5	SW	Switch node pin. This pin is the phase node of the regulator and is connected to the drain of the integrated MOSFET. Connect this pin to the inductor and diode.

3. Specifications

3.1 Absolute Maximum Ratings

Caution: Do not operate at or near the maximum ratings listed for extended periods of time. Exposure to such conditions can adversely impact product reliability and result in failures not covered by warranty.

Parameter	Minimum	Maximum	Unit
V _{IN}	-0.3	42	V
EN	-0.3	V _{IN} + 0.3	V
SW	-0.3	V _{IN} + 0.3	V
V _{OUT}	-0.3	7	V
SW, 20ns Transient	-6	V _{IN} + 0.3	V
Operating Junction Temperature	-40	150	°C
Maximum Storage Temperature Range	-65	150	°C
Human Body Model (Tested per JS-001-2017)	-	2	kV
Charged Device Model (Tested per JS-002-2018)	-	1	kV
Latch-Up (Tested per JESD78E; Class 2, Level A)	-	100	mA

3.2 Recommended Operating Conditions

Parameter	Minimum	Maximum	Unit
Input Voltage, V _{IN}	7	40	V
Output Current, I _{OUT}	0	0.3	A
Junction Temperature, T _J	-40	+125	°C

3.3 Thermal Specifications

Parameter	Package	Symbol	Conditions	Typical Value	Unit
Thermal Resistance	TSOT23-5	$\theta_{JA}^{[1]}$	Junction to ambient	90	°C/W
		$\theta_{JA}^{[2]}$	Junction to ambient	156	
		$\theta_{JC}^{[3]}$	Junction to case	48	

- $\theta_{JA}^{[1]}$ is measured in free air with the component mounted on RTKA211403DE0000BU/RTKA211405DE0000BU evaluation boards.
- $\theta_{JA}^{[2]}$ is measured in free air with the component mounted on a high-effective thermal conductivity test board. See [TB379](#).
- For $\theta_{JC}^{[3]}$, the case temperature location is the center of the package top surface.

3.4 Electrical Specifications

$T_J = -40^{\circ}\text{C}$ to $+125^{\circ}\text{C}$, $V_{IN} = 7\text{V}$ to 40V , unless otherwise noted. Typical values are at $T_A = +25^{\circ}\text{C}$. **Boldface limits apply across the junction temperature range, -40°C to $+125^{\circ}\text{C}$.**

Parameter	Symbol	Test Conditions	Min ^[1]	Typ	Max ^[1]	Unit
Supply Voltage						
V_{IN} Voltage Range	V_{IN}	-	7	-	40	V
V_{IN} Quiescent Current	I_Q	EN = $V_{IN} = 40\text{V}$, $V_{OUT} = 3.3\text{V}$ or 5V , no load operation, switching	-	4	-	μA
		EN = $V_{IN} = 40\text{V}$, $V_{OUT} > 3.3\text{V}$ or 5V , no load, no switching	-	2.5	-	μA
Shutdown Current	I_{SH}	EN = 0V , $V_{IN} = 24$, no switching	-	0.1	1	μA
V_{IN} Undervoltage Lockout	-	V_{IN} rising	6.0	6.5	7	V
V_{IN} Undervoltage Hysteresis	-	-	-	550	-	mV
Output Voltage						
V_{OUT} Valley Comparator Threshold	V_{OUT}	RAA211403, $V_{IN} = 12\text{V}$, no load	3.2	3.3	3.4	V
		RAA211405, $V_{IN} = 12\text{V}$, no load	4.8	4.95	5.1	V
Overvoltage Protection	OVP	RAA211403	-	3.63	-	V
		RAA211405	-	5.5	-	V
Enable Voltage						
EN High Level Input Voltage	V_{ENH}	-	1.13	1.23	1.33	V
EN Hysteresis	-	-	-	75	-	mV
EN Leakage Current	-	EN = $V_{IN} = 40\text{V}$	-	0	-	μA
Timer Control						
Minimum On-Time	t_{ON_MIN}	$V_{IN} = 12\text{V}$	-	75	-	ns
Internal Integrated MOSFETs						
On-Resistance	$r_{DS(ON)_H}$	$V_{IN} = 12\text{V}$	-	1.0	-	Ω
Current Limit and Protection						
Current Limit	I_{LIM}	$V_{IN} = 12\text{V}$	-	0.750	-	A
Current Limit Prop Delay	-	-	-	50	-	ns
Thermal Shutdown	TSD	-	-	160	-	$^{\circ}\text{C}$
Thermal Hysteresis	ΔTSD	-	-	20	-	$^{\circ}\text{C}$

- Parameters with MIN and/or MAX limits are 100% tested at $+25^{\circ}\text{C}$, unless otherwise specified. Temperature limits established by characterization and are not production tested.

4. Typical Performance Graphs

$V_{IN} = 24V$, $V_{OUT} = 3.3$ or $5V$, $I_{OUT} = 300mA$, $L = 15\mu H$ (RAA211403), $L = 10\mu H$ (RAA211405), $C_{OUT} = 22\mu F$, $T_A = +25^\circ C$, unless otherwise stated.

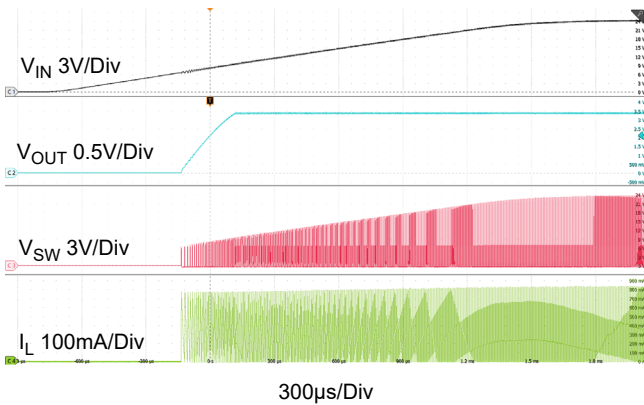

Figure 5. Startup through V_{IN} : RAA211403

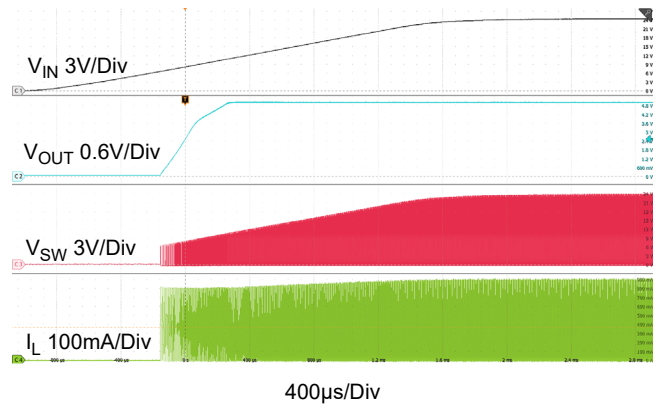

Figure 6. Startup through V_{IN} : RAA211405

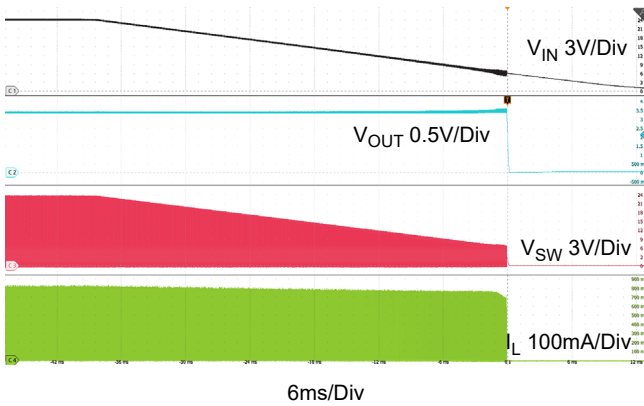

Figure 7. Shutdown through V_{IN} : RAA211403

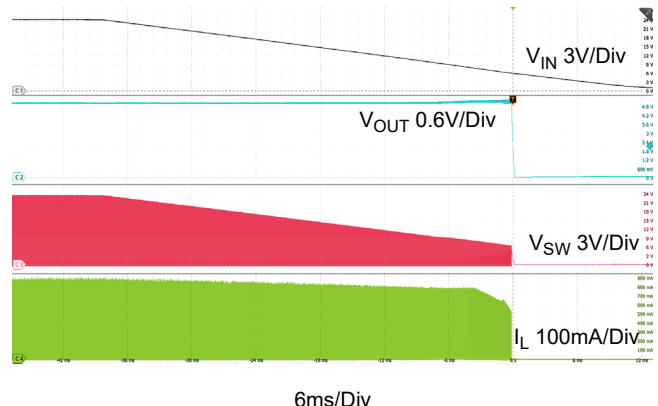

Figure 8. Shutdown through V_{IN} : RAA211405

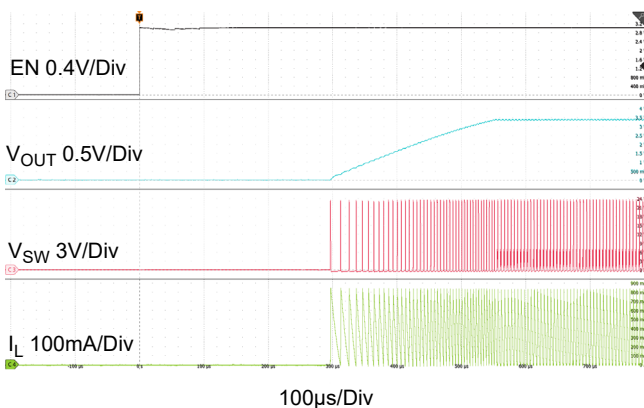

Figure 9. Startup through EN: RAA211403

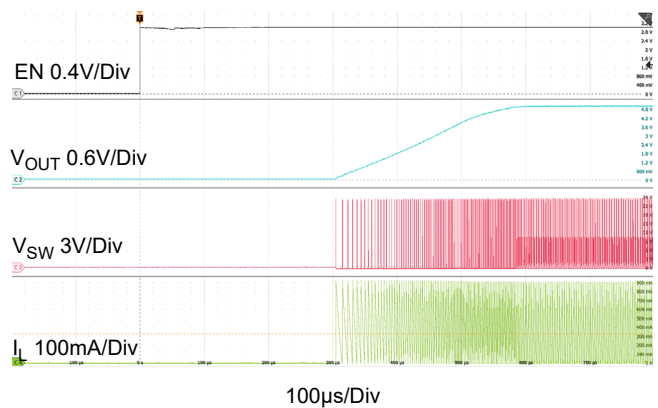

Figure 10. Startup through EN: RAA211405

$V_{IN} = 24V$, $V_{OUT} = 3.3$ or $5V$, $I_{OUT} = 300mA$, $L = 15\mu H$ (RAA211403), $L = 10\mu H$ (RAA211405), $C_{OUT} = 22\mu F$, $T_A = +25^\circ C$, unless otherwise stated. (Cont.)

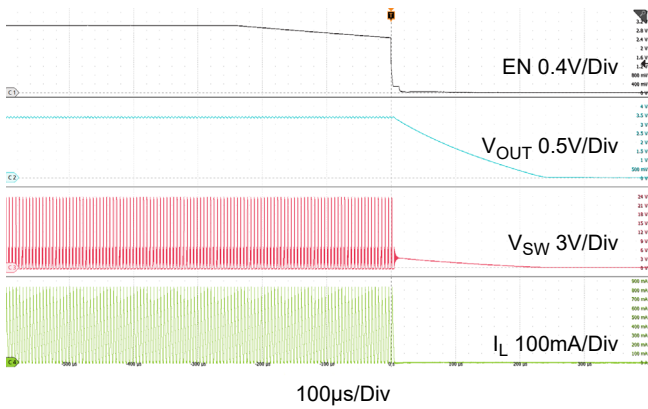

Figure 11. Shutdown through EN: RAA211403

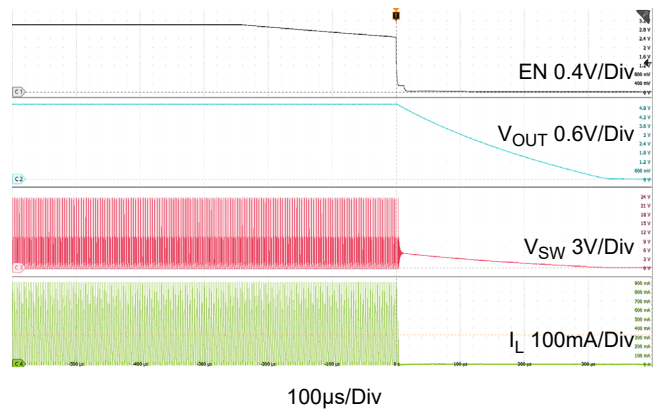

Figure 12. Shutdown through EN: RAA211405

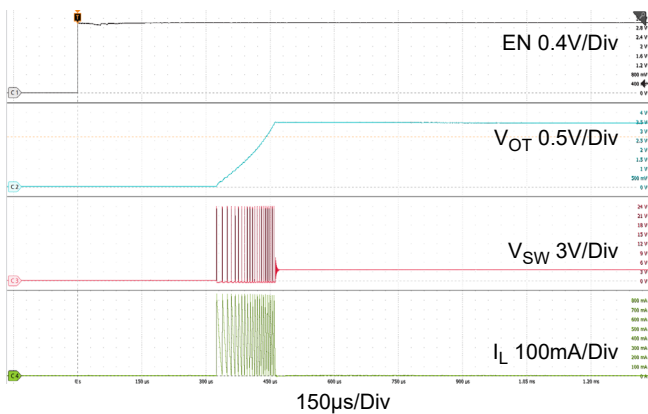

Figure 13. Startup through EN (No Load): RAA211403

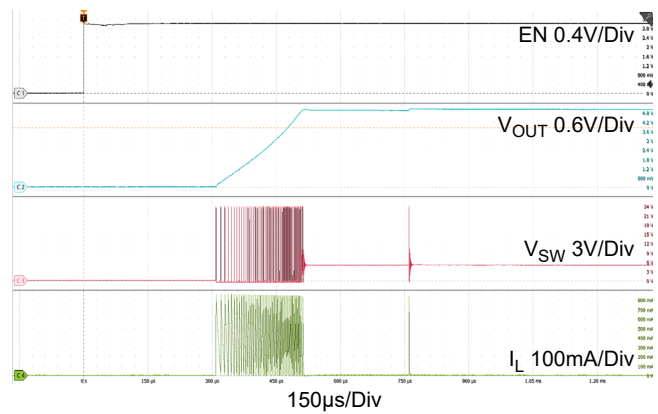

Figure 14. Startup through EN (No Load): RAA211405

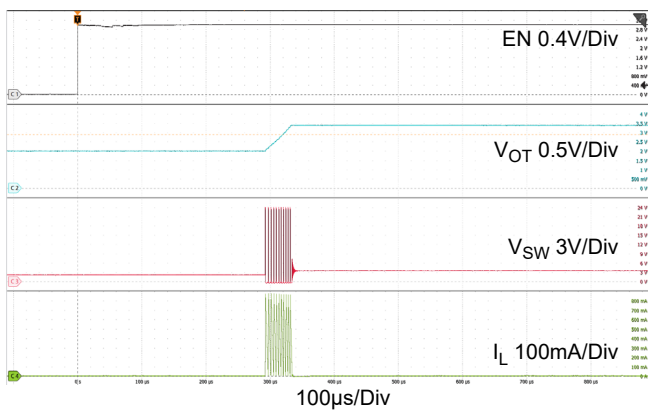

Figure 15. Startup through EN with Pre-biased (2V) Output Voltage (No Load): RAA211403

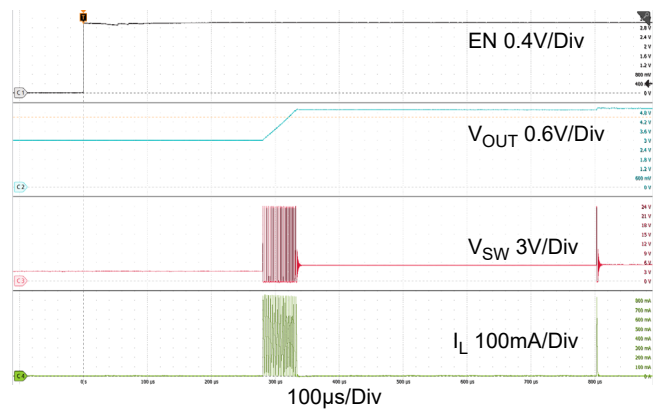

Figure 16. Startup through EN with Pre-Bias (3V) Output Voltage (No Load): RAA211405

$V_{IN} = 24V$, $V_{OUT} = 3.3$ or $5V$, $I_{OUT} = 300mA$, $L = 15\mu H$ (RAA211403), $L = 10\mu H$ (RAA211405), $C_{OUT} = 22\mu F$, $T_A = +25^\circ C$, unless otherwise stated. (Cont.)

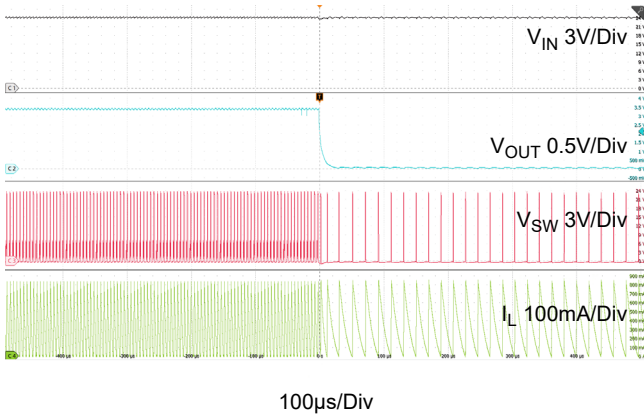

Figure 17. Short-Circuit: RAA211403

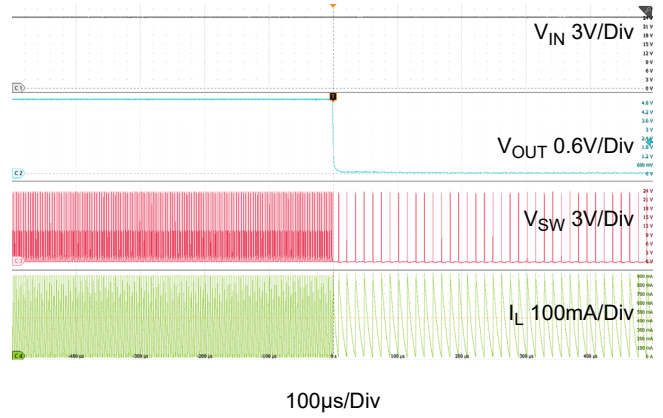

Figure 18. Short-Circuit: RAA211405

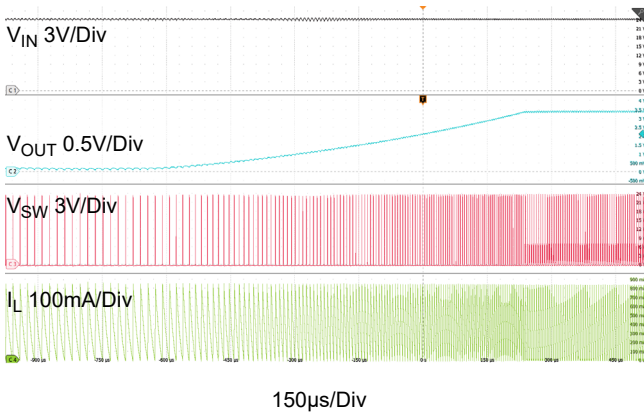

Figure 19. Recovery from Short-Circuit and Startup to Full Load: RAA211403

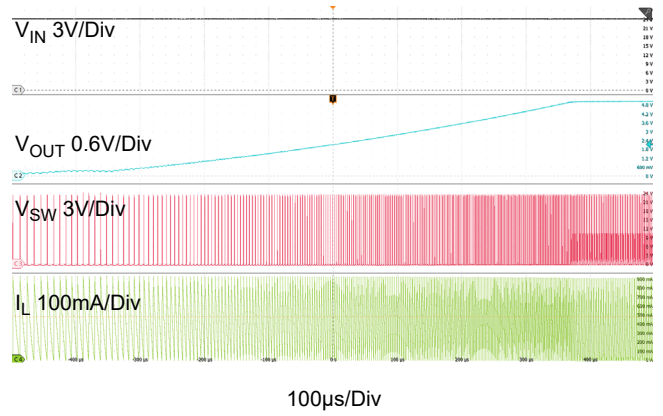

Figure 20. Recovery from Short-Circuit and Startup to Full Load: RAA211405

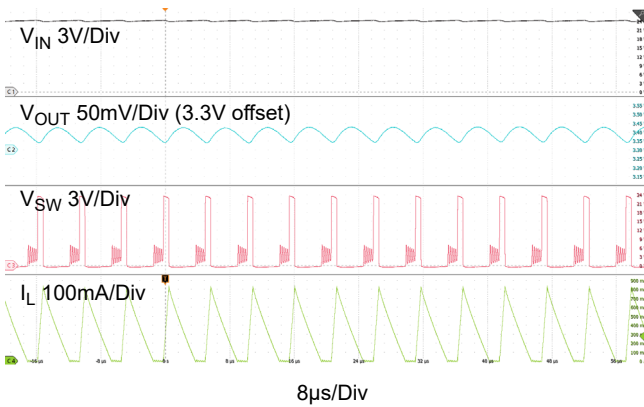

Figure 21. Typical Operation (Full Load): RAA211403

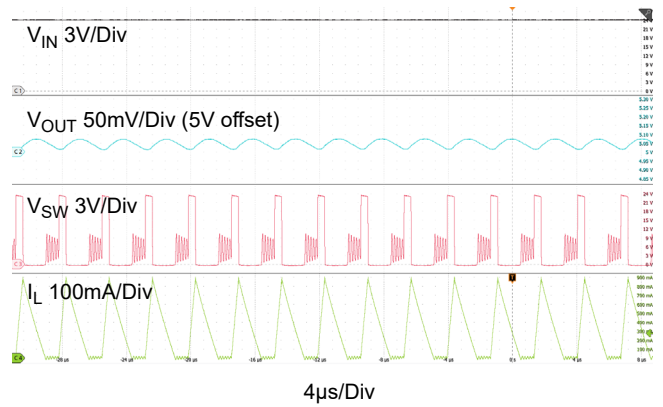

Figure 22. Typical Operation (Full Load): RAA211405

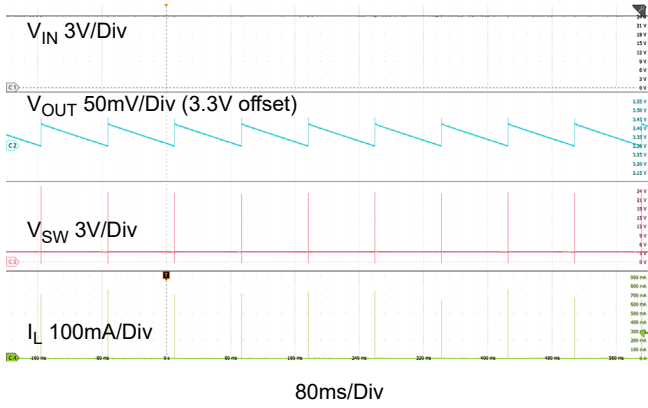

Figure 23. Typical Operation (No Load): RAA211403

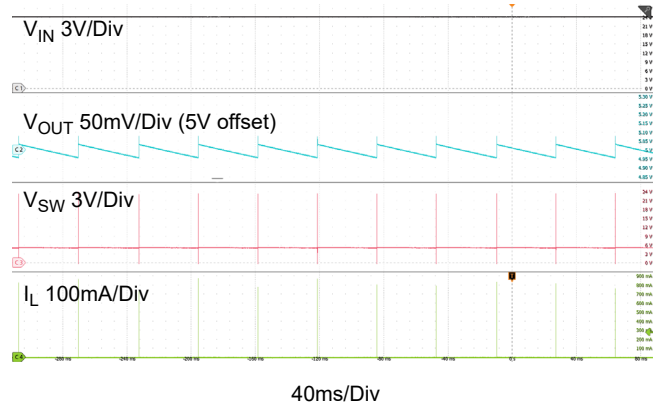

Figure 24. Typical Operation (No Load): RAA211405

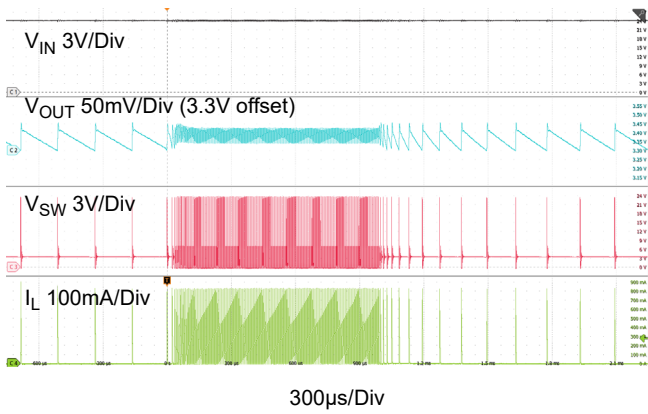

Figure 25. Load Transient (10mA to 300mA): RAA211403

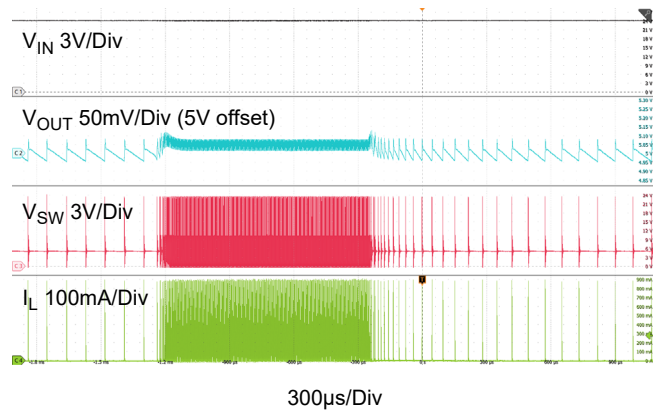

Figure 26. Load Transient (10mA to 300mA): RAA211405

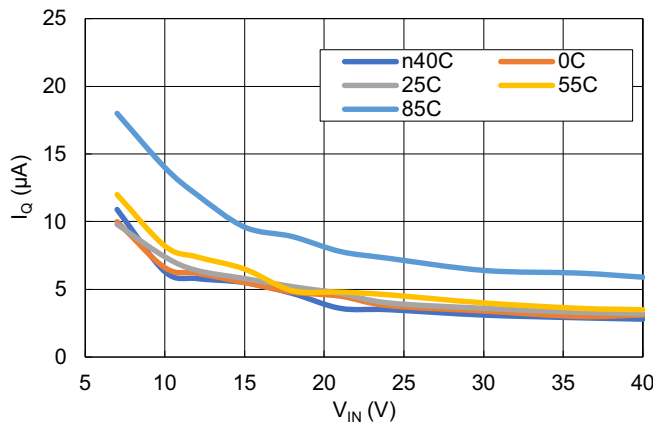

Figure 27. I_Q vs V_{IN} (In Regulation, No Load): RAA211403

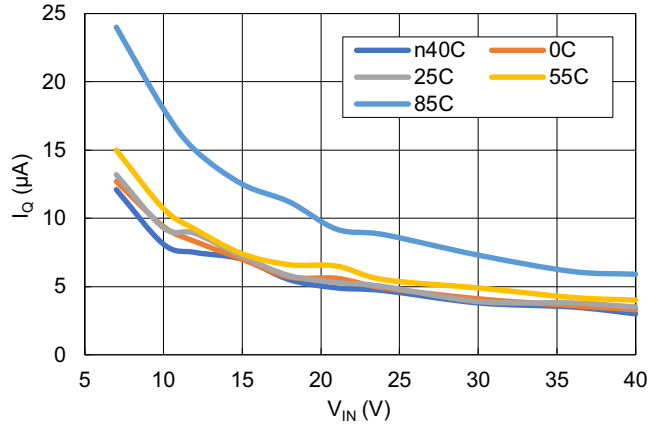

Figure 28. I_Q vs V_{IN} (In Regulation, No Load): RAA211405

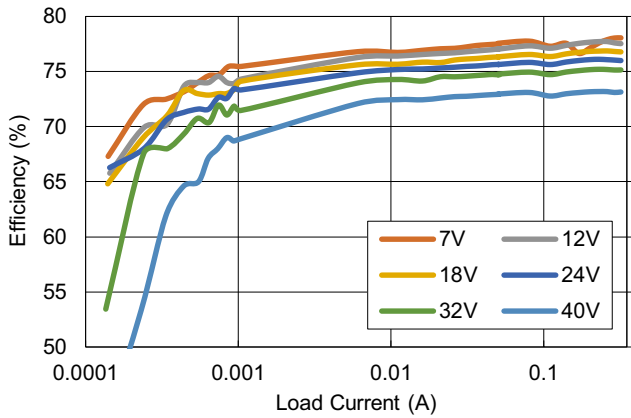

Figure 29. Efficiency: RAA211403

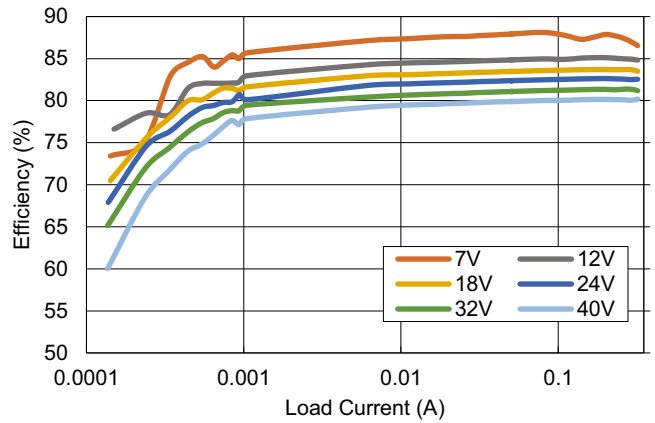

Figure 30. Efficiency: RAA211405

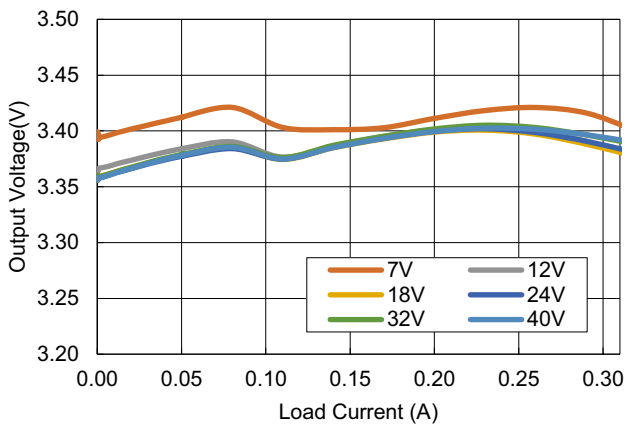

Figure 31. Load Regulation: RAA211403

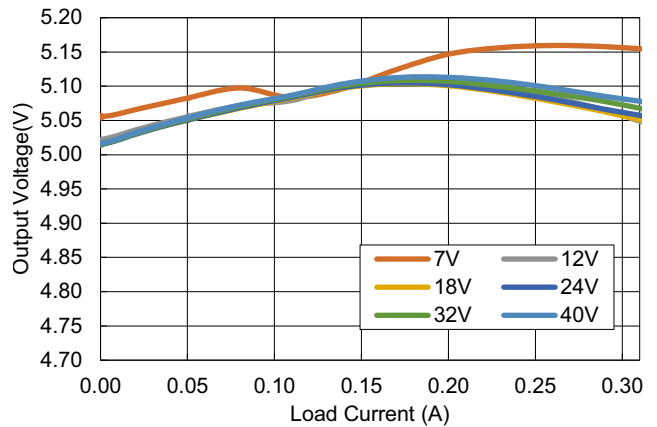

Figure 32. Load Regulation: RAA211405

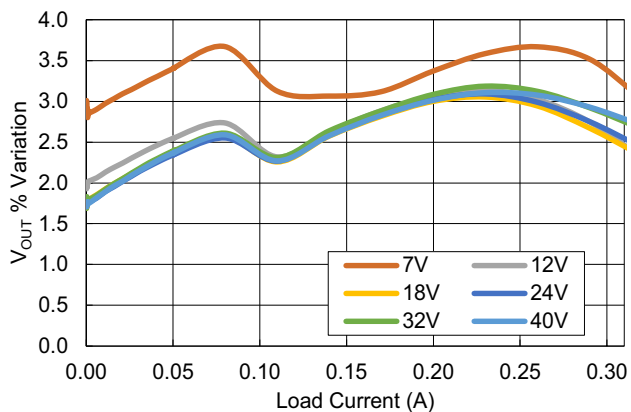

Figure 33. V_{OUT} Variation: RAA211403

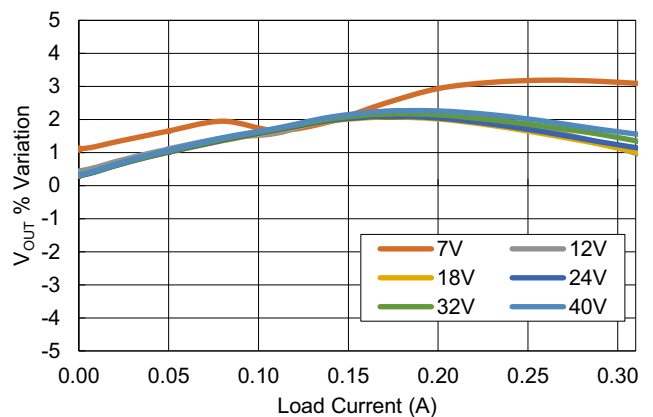

Figure 34. V_{OUT} Variation: RAA211405

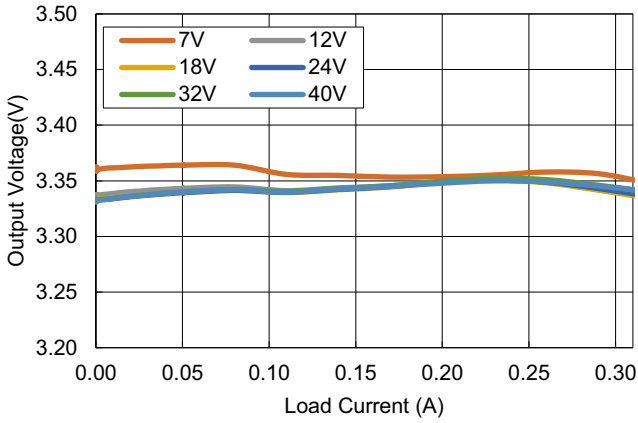

Figure 35. Load Regulation: RAA211403 ($C_{OUT} = 2 \times 22\mu F$)

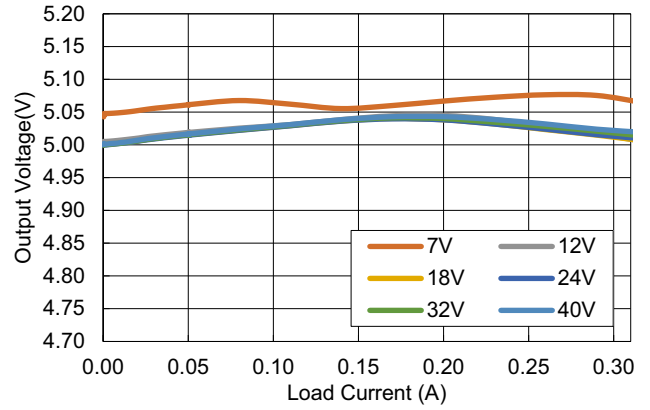

Figure 36. Load Regulation: RAA211405 ($C_{OUT} = 2 \times 22\mu F$)

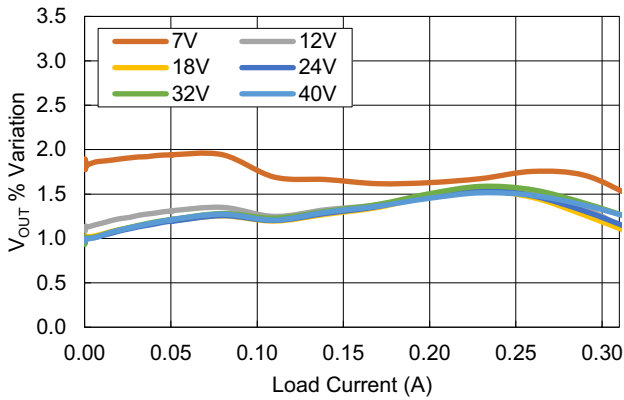

Figure 37. V_{OUT} Variation: RAA211403 ($C_{OUT} = 2 \times 22\mu F$)

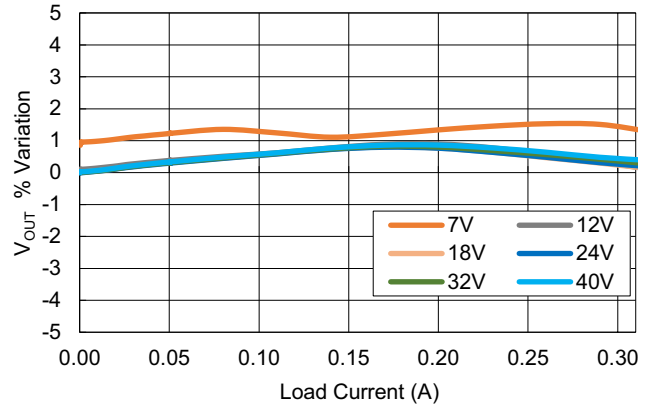

Figure 38. V_{OUT} Variation: RAA211405 ($C_{OUT} = 2 \times 22\mu F$)

5. Functional Description

The RAA211403/405 are easy-to-use 300mA low I_Q step-down regulators with a wide input voltage range of 7V to 40V across the -40°C to 125°C junction temperature range.

The regulators start switching when the input and enable voltage reaches their thresholds. They use a fixed current reference to turn the MOSFET off, and an output voltage valley threshold to turn the MOSFET back on. The following briefly describes the operation of the regulators.

The output voltage is sensed on the VOUT pin through internal feedback resistors and is compared with the internal reference of 1.2V to produce the control signal, which decides when to turn on the MOSFET. The MOSFET is switched on when both the following conditions are met:

- The inductor current hits zero
- The output voltage drops below a fixed V_{OUT} threshold

When the MOSFET is on, the inductor current rises linearly depending on the inductor and input voltage values. The MOSFET is switched off when the inductor current reaches the fixed I_{LIM} current threshold of 750mA (typical). Therefore, the regulators always operate in discontinuous current mode and need V_{OUT} ripple for the control scheme to function.

The switching frequency can be programmed by changing the inductor value. The operating frequency depends on the inductor, the input voltage, and the load current (See Figure 49 to Figure 54). As the peak current is fixed for a particular input voltage, the switching frequency is tied to the load. The charge (or current) in each switching cycle is fixed. Therefore, an increase in the load current is met by an increase in the switching frequency.

The no-load switching quiescent current (I_Q) at input 40V is 4 μA .

5.1 Peak Current and Propagation Delay

The regulators control the inductor peak current at 750mA (typical). However, because of the current sensor propagation delay, the peak current tends to be higher than 750mA. The propagation delay is typically 50ns.

Use Equation 1 to approximately calculate the actual inductor peak current.

$$(EQ. 1) \quad I_{peak} = 0.750 + 50 \times 10^{-9} \times \frac{(V_{IN} - V_{OUT})}{L}$$

In addition, the regulator has a minimum MOSFET turn-on time. Therefore, choosing too small of an inductance value may result in a current higher than predicted by Equation 1. Renesas recommends a minimum inductance of 4.7 μH or higher. Figure 39 and Figure 40 show the peak inductor current versus input voltage graphs for a few recommended inductors.

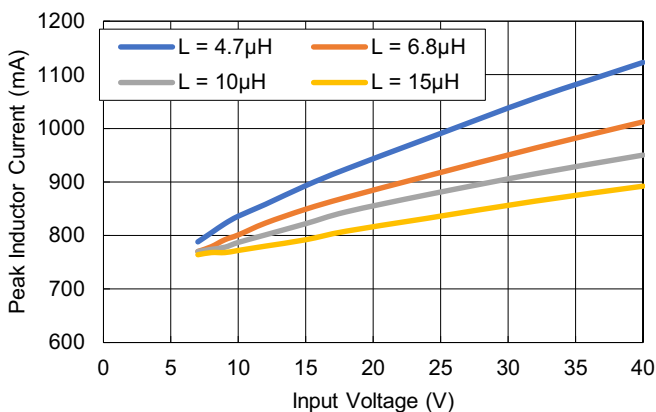

Figure 39. Peak Inductor Current: RAA211403

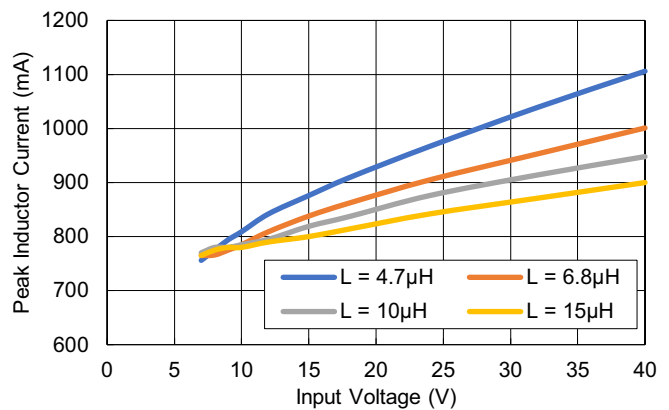

Figure 40. Peak Inductor Current: RAA211405

5.2 Soft-Start

The RAA211403 and RAA211405 are naturally current-limited and automatically provide a smoothly rising V_{OUT} voltage on power-up. Because the total output load of the device is limited, a startup with a heavy load generates a longer V_{OUT} ramp, and a startup with no load generates a faster ramp.

Soft-start time is approximately defined by Equation 2.

$$(EQ. 2) \quad \text{Soft-Start Time} = V_{OUT} \times \left[\frac{C_{OUT}}{\left(\frac{I_{peak}}{2}\right) - I_{LOAD}} \right]$$

The approximate soft-start time based on the evaluation boards (RTKA211403DE00BU and RTKA211405DE00BU) is given in Table 3, Table 4, and Figure 41 to Figure 46.

Table 3. Approximate Soft-Start Times (RAA211403)

Inductor (μH)	Soft-Start Time (No Load) ^[1] (μs)	Soft-Start Time (Full Load) ^[1] (μs)
15	135	235
10	130	210
6.8	125	200
4.7	110	170

1. Test conditions: V_{IN} = 24V, C_{OUT} = 22μF (PN:GRM187R61A226ME15), L = 15μH (PN:74438335150), Power supply: Chroma-632012P-100-50, Load: Resistive Load equivalent to full load at nominal V_{OUT}, measured through 0 to 100% of nominal V_{OUT}

Table 4. Approximate Soft-Start Times (RAA211405)

Inductor (μH)	Soft-Start Time (No Load) ^[1] (μs)	Soft-Start Time (Full Load) ^[1] (μs)
15	210	370
10	190	360
6.8	180	285
4.7	175	265

1. Test conditions: V_{IN} = 24V, C_{OUT} = 22μF (PN:GRM219R61C226ME15), L = 10μH (PN:74438335100), Power supply: Chroma-632012P-100-50, Load: Resistive Load equivalent to full load at nominal V_{OUT}, measured through 0 to 100% of nominal V_{OUT}

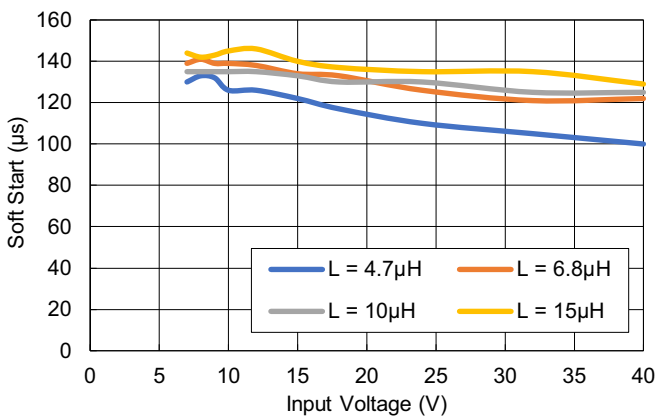

Figure 41. Soft-Start (No Load): RAA211403

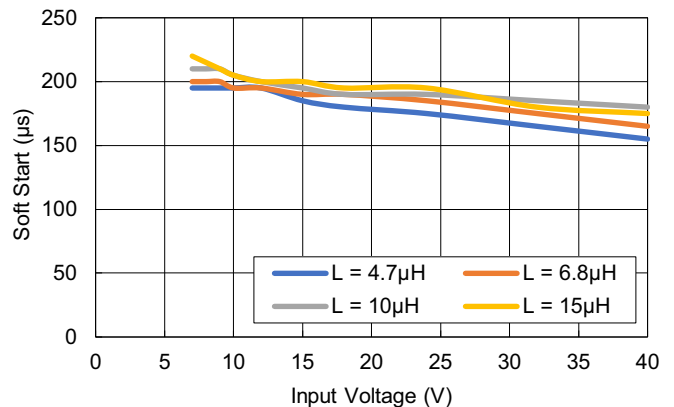

Figure 42. Soft-Start (No Load): RAA211405

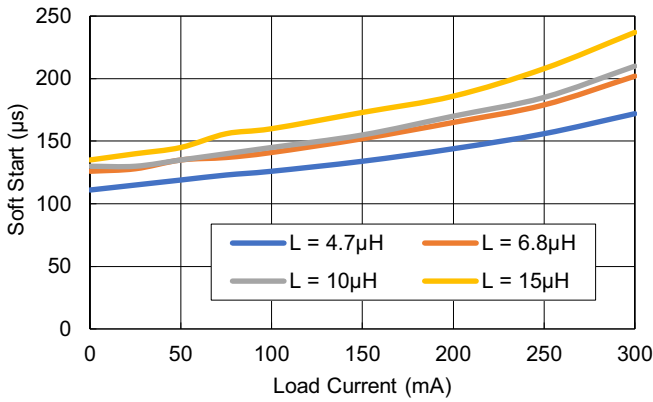

Figure 43. Soft-Start ($V_{IN} = 24V$): RAA211403

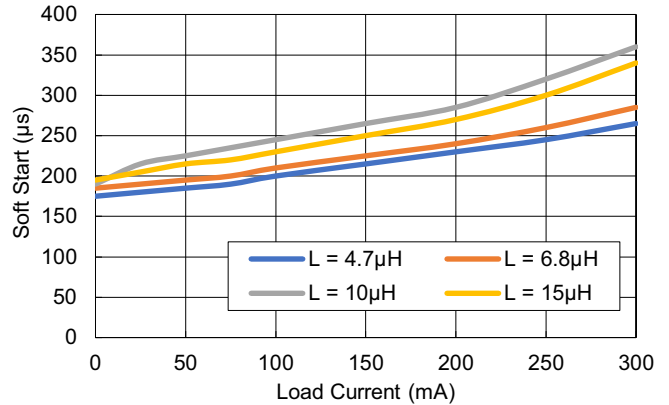

Figure 44. Soft-Start ($V_{IN} = 24V$): RAA211405

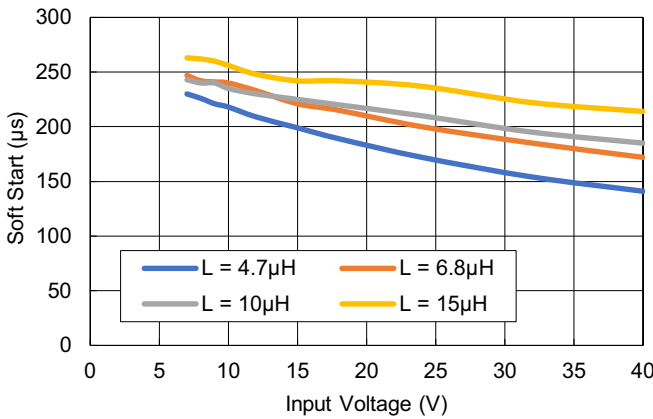

Figure 45. Soft-Start (Resistive Full Load): RAA211403

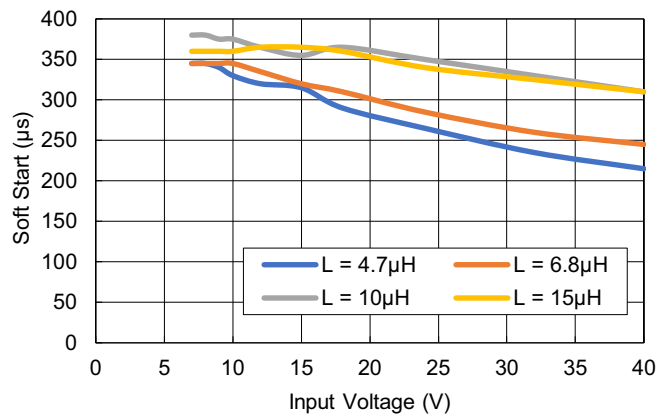

Figure 46. Soft-Start (Resistive Full Load): RAA211405

5.3 Undervoltage Lockout

The devices have an Undervoltage Lockout (UVLO) on the VIN pin. It prevents the regulators from starting up until the input voltage exceeds 6.5V (typical). The UVLO threshold has approximately 550mV of hysteresis. Therefore, the device continues to operate when VIN decreases until it drops below 6V (typical). Hysteresis prevents the part from turning off during power-up if the VIN is non-monotonic. Renesas recommends making the current path length from the VIN power supply or upstream input power supply to the IC as small as possible to prevent jittering during VIN turn-off and turn-on.

5.4 Enable Control

The devices have an enable pin that turns them on when pulled high. When EN is low, the ICs shut down (See Figure 9 to Figure 12). They have an EN rising threshold voltage of 1.2V (typical). EN threshold hysteresis is 75mV (typical).

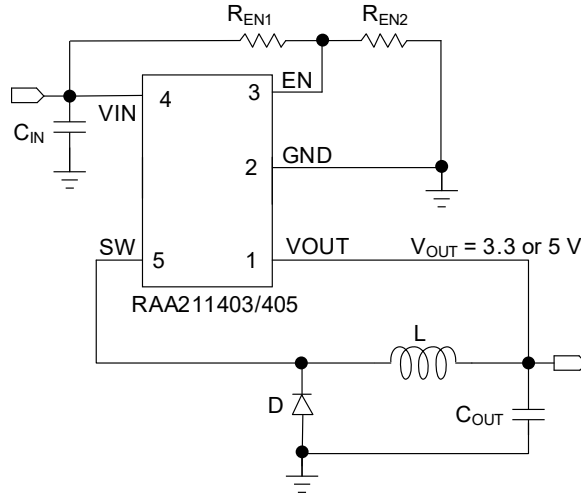

Figure 47. Typical Application Circuit Diagram with VIN UVLO Programming by ENABLE

The EN pin can be tied directly to VIN for always-on operation. The devices have an accurate Enable threshold that allows programming the VIN UVLO threshold by connecting VIN to EN using a resistor divider. The UVLO can be set with the resistor divider based on Equation 3, where VINR is the rising threshold of VIN UVLO (see Figure 47)

$$(EQ. 3) \quad \frac{R_{EN1}}{R_{EN2}} = \left(\frac{V_{INR} - 1.2}{1.2} \right)$$

Calculate the resulting input voltage for the part to be turned off using Equation 4:

$$(EQ. 4) \quad V_{INF} = 1.125 \times \frac{R_{EN1} + R_{EN2}}{R_{EN2}}$$

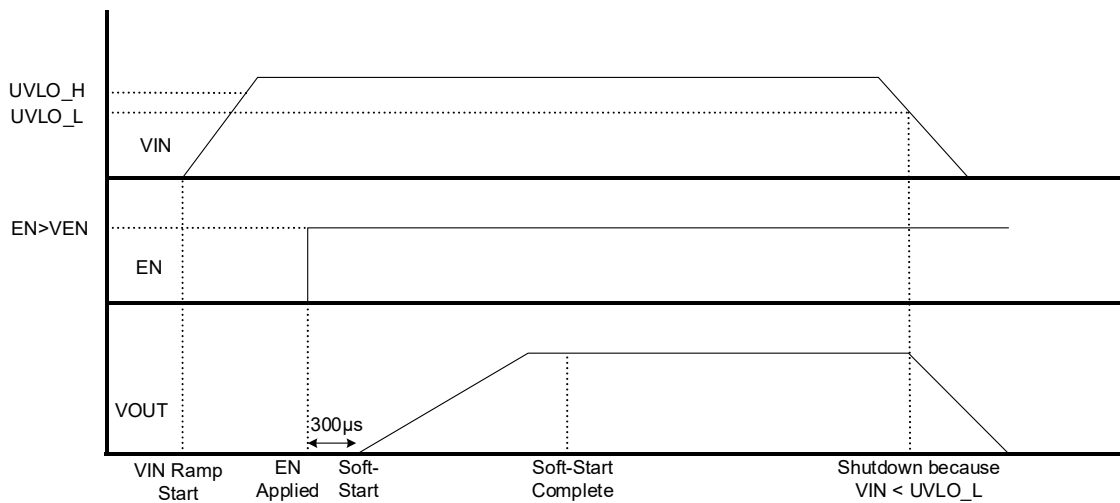

Figure 48. Timing Diagram with EN Turn-On and VIN UVLO Turn-Off

5.5 Overcurrent Protection (OCP)

RAA211403 and RAA211405 have built-in peak current protection with control. The MOSFET current is constantly monitored to turn off the MOSFET at 750mA (typical) peak current.

5.6 Short Circuit

The devices operate on boundary current mode during a short-circuit condition. The regulator still switches based on the control previously described. The output current during a short-circuit condition is given by [Equation 5](#) and shown in [Figure 17](#) to [Figure 20](#):

$$(EQ. 5) \quad I_{OUT} = \frac{I_{peak}}{2}$$

5.7 V_{OUT} Overvoltage Protection (OVP)

RAA211403 and RAA211405 have an output overvoltage protection. The internal overvoltage comparator compares the FB pin 110% of the reference voltage (see [Figure 2](#)). When this voltage exceeds 110% of the nominal, the regulator turns off the MOSFET. The MOSFET turns back on when the V_{OUT} voltage goes below the V_{OUT} valley threshold defined by the controller.

5.8 Pre-Biased Output Voltage

The part functions per the control scheme highlighted in the block diagram with an existing output voltage on the output pin. [Figure 15](#) and [Figure 16](#) show the start-up signals when the controller is enabled with pre-existing output voltage. The start-up is smooth, monotonic, and free from any glitches.

The part shuts off when the biased output voltage is above the V_{OUT} comparator's valley threshold, and no switching signal is given to the FET. This feature is useful in systems with paralleled power supplies for redundancy (to maintain high reliability) without the addition of any additional circuitry. This feature can be used as power saving feature, as the typical I_Q of the part is 2.5μA at no load and no switching conditions.

5.9 Over-Temperature Protection (OTP)

Over-temperature protection (OTP) limits the maximum junction temperature in the devices. This protection limits total power dissipation by shutting off the regulator when the junction temperature of the ICs exceeds 160°C (typical). There is a 20°C hysteresis for OTP. After the junction temperature drops below 140°C, the devices resume operation by stepping through soft-start.

5.10 Switching Frequency

The regulator is a variable frequency converter, and the switching frequency varies proportionally to the load. The maximum switching frequency is dependent on inductance and peak current.

Choose 15µH for a maximum frequency of approximately 210kHz (for RAA211403) and 10µH for a maximum frequency of 380kHz (for RAA211405). The bench data based on our evaluation boards (RTKA211403DE0000BU and RTKA211405DE0000BU) is shown in Figure 49 to Figure 54.

The switching frequency can be approximately given by Equation 6.

$$(EQ. 6) \quad \text{Switching Frequency} = \frac{2 \times I_{LOAD}}{L \times I_{peak} \times I_{peak} \times \left(\frac{1}{V_{IN} - V_{OUT}} + \frac{1}{V_{OUT}} \right) \times \text{Efficiency}}$$

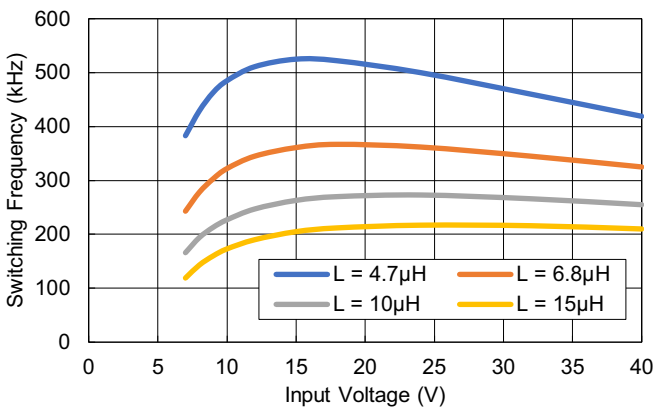

Figure 49. Switching Frequency vs Input Voltage
Full Load (300mA): RAA211403

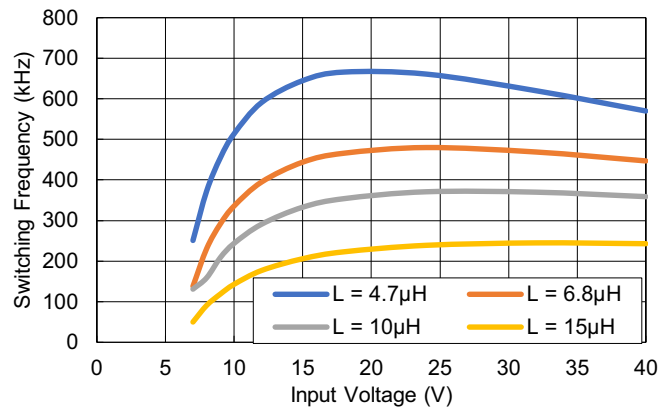

Figure 50. Switching Frequency vs Input Voltage
Full Load (300mA): RAA211405

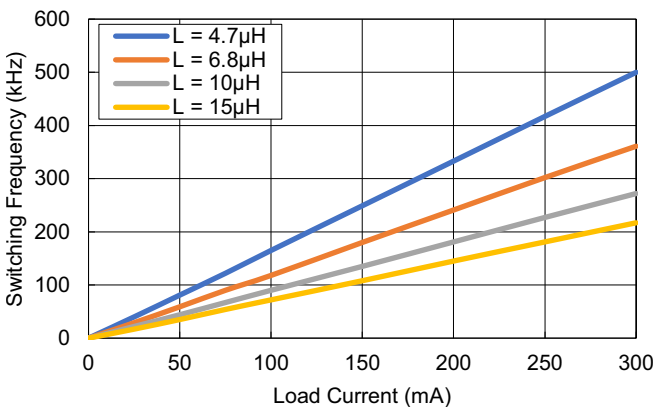

Figure 51. Switching Frequency vs Load Current
VIN = 24V: RAA211403

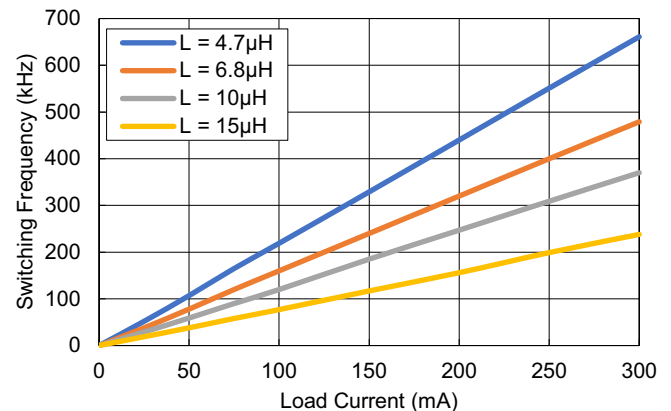

Figure 52. Switching Frequency vs Load Current
VIN = 24V: RAA211405

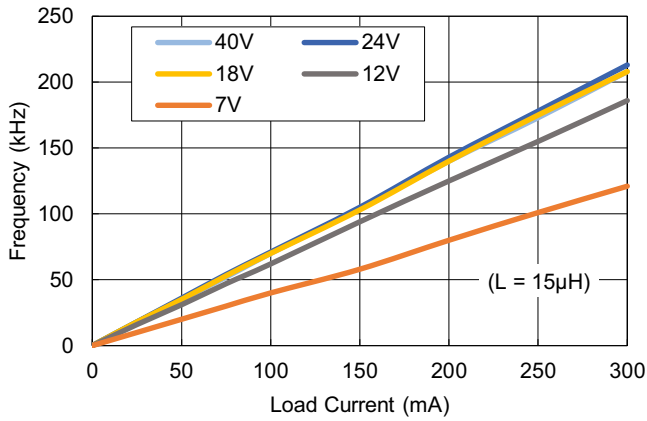

Figure 53. Switching Frequency vs Load Current (different input voltage): RAA211403

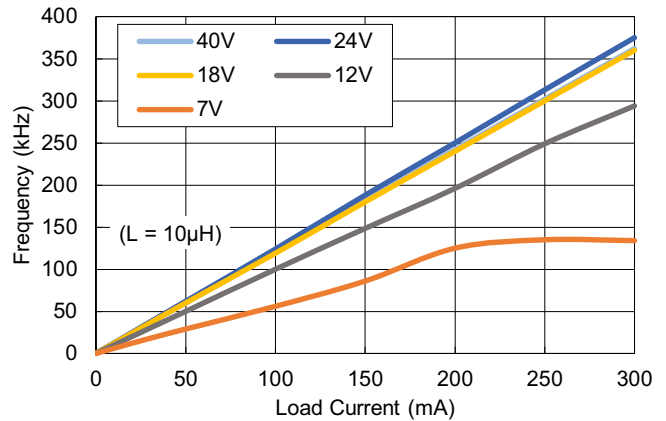

Figure 54. Switching Frequency vs Load Current (different input voltage): RAA211405

5.11 Thermal Derating

The devices do not have thermal derating in the operating range. On the evaluation board RTKA211403DE0000BU or RTKA211405DE0000BU, the IC operates approximately 20-25°C higher than the ambient temperature at full load. The regulators can operate on all operating voltage and current ranges from -40°C to 125°C ambient temperature without shutting down. The device has an over-temperature shutdown at 160°C junction temperature.

5.12 Fault Summary

Top Level faults (VIN UVLO, OTP) stop VOUT and enter the power-on reset (POR) state until the fault is relieved; next, the chip starts normally according to the EN state.

Fault	Detection Delay	Design Implementation
V _{IN} UVLO	2µs	Power On Reset (POR), chip restarts from initial reset state when UVLO is satisfied.
OT_shutdown	Immediate	Device shutdown and recovery after OT hysteresis is met, internal circuit monitor OT hysteresis.
Current Limit	Immediate	When the high-side MOSFET reaches current limit, the MOSFET turns off.
V _{OUT} Short	Immediate	Device operates in current limit mode.
V _{OUT} OVP	Immediate	When V _{OUT} reached the OVP limit, the MOSFET turns off.

6. Component Selection

6.1 Input Capacitor

The input capacitor in a buck converter maintains the input voltage by suppressing the voltage ripple induced by discontinuous switching current.

Renesas recommends using low ESR/low ESL ceramic capacitors across the input of the regulator. When selecting ceramic capacitors for power supply applications, it is important to consider that the effective capacitance reduces with DC bias voltage across it. Therefore, consult the capacitor datasheet to understand the impact of this effect. Renesas also recommends using X5R/X7R dielectric ceramic capacitors because of their small temperature coefficient. In addition, as RAA211403/405 are low quiescent current regulators, picking an input capacitor with a minimum voltage rating of 50V with a low leakage current is advised.

Choose a input capacitor of minimum 4.7μF. If the input to the regulator is fed through a high-impedance path, Renesas recommends adding an electrolytic capacitor and the ceramic capacitor to dampen the input voltage oscillation effects.

6.2 Output Capacitor

Output capacitor selection impacts the steady state and transient performance of the buck converter. Factors such as output ripple voltage, output voltage excursion during transients, and output voltage regulation should be considered when selecting the output capacitor. Renesas recommends using low ESR/low ESL X5R/X7R dielectric ceramic for the output capacitor with a minimum voltage rating of 10V for RAA211403 and 16V for RAA211405. It is important to consider that the effective capacitance reduces with DC bias voltage across it. Therefore, consult the capacitor datasheet to understand the impact of this effect. Use [Equation 7](#) to approximate the output voltage ripple, where I_{PEAK} is the peak inductor current from [Equation 1](#).

$$(EQ. 7) \quad V_{RIPPLE(C)} = \frac{L(I_{PEAK} - I_{OUT})^2}{2C_{OUT}V_{OUT}} \left(\frac{V_{IN}}{V_{IN} - V_{OUT}} \right)$$

Use [Equation 7](#) for initial capacitor selection. Select the final value based on testing a prototype board, capacitor DC bias derating, and capacitor ESR.

Output capacitance determines the output voltage ripple and V_{OUT} regulation for RAA211403/405. Choose a minimum of 10μF for the smallest area or a larger output capacitor to reduce ripple and provide tighter voltage regulation (see [Figure 31](#) to [Figure 38](#)).

6.3 Inductor

Select an inductor with the lowest possible DC resistance (DCR) to minimize power losses. The continuous current rating of the inductor should be high enough to accommodate the DC load current and AC ripple current with an additional margin for overload conditions. The saturation current rating should be more than the peak inductor current. The factory recommends a minimum inductance of 4.7μH or higher with a minimum saturation current of 1A. See [Figure 39](#) and [Figure 40](#) for inductor peak current values with different inductances.

6.4 Diode

The devices require a freewheeling diode for the inductor current to flow when the internal high-side MOSFET turns off. Select a diode with a reverse voltage rating at least 20% higher than the maximum input voltage. The continuous current rating of the diode should be greater than the highest output current. Select a diode with low forward voltage drop and fast reverse recovery time for better efficiency. For operation at high temperatures, Renesas recommends using a high-quality Schottky, as diode leakage increases the current consumption of the application. Renesas recommends a minimum reverse breakdown voltage of 50V, a continuous current rating of 0.5 A, and a peak current rating of 1A.

7. Layout Guidelines

The printed circuit board (PCB) layout is critical for proper operation of the RAA211403/405. The following guidelines are recommended to achieve good performance.

- Use multilayer PCB structure to achieve optimized performance. Our evaluation boards (RTKA211403DE0000BU and RTKA211405DE0000BU) use a two layer PCB with 1oz copper and bottom layer as ground.
- Place the input capacitor as close as possible to the IC. Input capacitor is the most important component for any step-down converter and should be the first component to be placed in the layout.
- The copper area of the SW node should not be more than needed. Place the inductor close to the regulator.
- Place an output capacitor close to the inductor.
- Place and route the power component to keep the power loop area minimum and short as possible.
- Keep all the power component to the same side of the PCB.
- Include thermal vias, as necessary, to improve heat dissipation.

The recommended PCB board layout example is shown in [Figure 55](#) and [Figure 56](#).

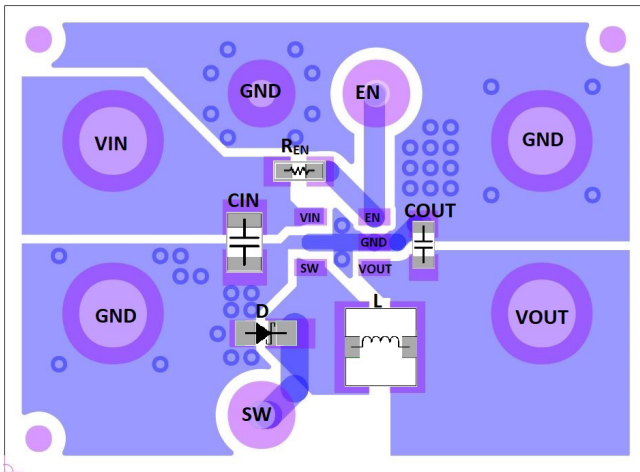

Figure 55. Layout (Top Layer)

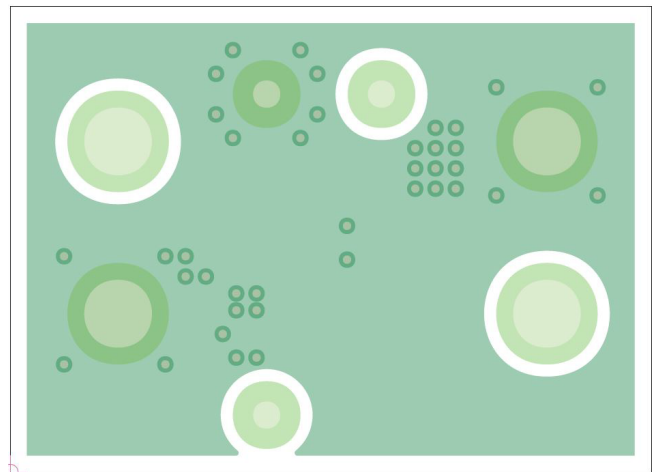

Figure 56. Layout (Bottom Layer)

8. Package Outline Drawing

For the most recent package outline drawing, see [P5.064B](#).

P5.064B

5 Lead Thin Small Outline Transistor (TSOT) Plastic Package

Rev 3, 2/2022

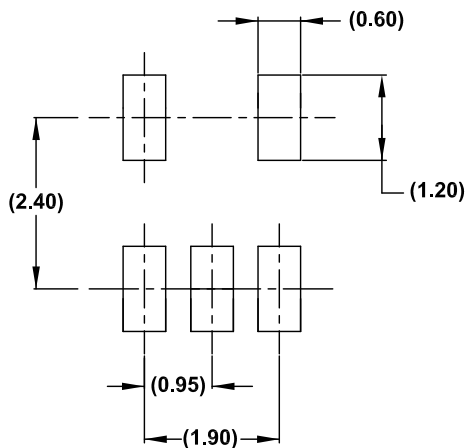
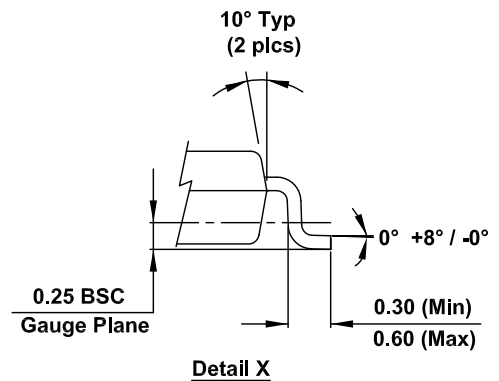
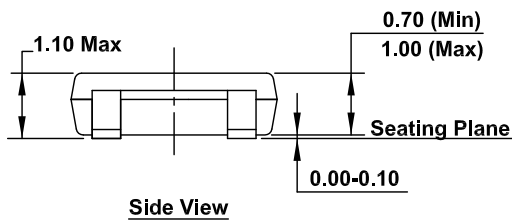
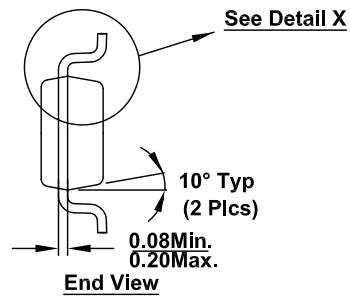
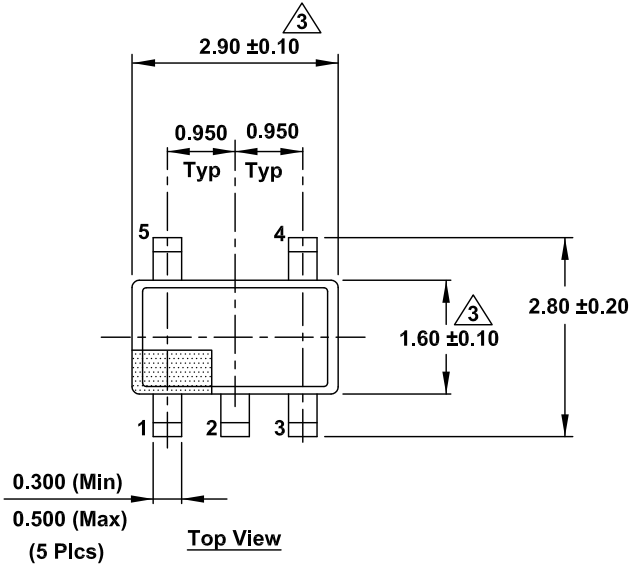

NOTE:

1. Dimensioning and tolerancing conform to ASME Y14.5m-1994.
2. Die is facing up for mold. Die is facing down for trim/form, that is reverse trim/form.
3. Dimensions are exclusive of mold flash and gate burr.
4. The footlength measuring is based on the gauge plane method.
5. All specifications comply to JEDEC Spec MO193 Issue C.

9. Ordering Information

Part Number ^{[1][2]}	Part Marking ^[3]	Package Description ^[4] (RoHS Compliant)	Pkg. Dwg #	Carrier Type ^[5]	Temp. Range
RAA2114034GP3#JA0	403	TSOT-23	P5.064B	Reel, 3k	-40 to +125°C
RAA2114054GP3#JA0	405				
RTKA211403DE0000BU	RAA211403 Evaluation Board				
RTKA211405DE0000BU	RAA211405 Evaluation Board				

1. These Pb-free plastic packaged products employ special Pb-free material sets; molding compounds/die attach materials and NiPdAu plate - e4 termination finish, which is RoHS compliant and compatible with both SnPb and Pb-free soldering operations. Pb-free products are MSL classified at Pb-free peak reflow temperatures that meet or exceed the Pb-free requirements of IPC/JEDEC J-STD-020.
2. For Moisture Sensitivity Level (MSL), see the [RAA211403](#), [RAA211405](#) product pages. For more information about MSL, see [TB363](#).
3. The part marking is located on the bottom of the part.
4. For the Pb-Free Reflow Profile, see [TB493](#).
5. See [TB347](#) for details about reel specifications.

10. Revision History

Revision	Date	Description
1.03	Dec 1, 2023	Updated COUT information in Tables 1 and 2. Updated Equation 6.
1.02	Jul 3, 2023	Changed POD information from P5.064D to P5.064B throughout the document. Added Note 4 to the ordering information table.
1.01	Jun 4, 2023	Updated Figures 51 and 52.
1.00	May 16, 2023	Initial release.

IMPORTANT NOTICE AND DISCLAIMER

RENESAS ELECTRONICS CORPORATION AND ITS SUBSIDIARIES (“RENESAS”) PROVIDES TECHNICAL SPECIFICATIONS AND RELIABILITY DATA (INCLUDING DATASHEETS), DESIGN RESOURCES (INCLUDING REFERENCE DESIGNS), APPLICATION OR OTHER DESIGN ADVICE, WEB TOOLS, SAFETY INFORMATION, AND OTHER RESOURCES “AS IS” AND WITH ALL FAULTS, AND DISCLAIMS ALL WARRANTIES, EXPRESS OR IMPLIED, INCLUDING, WITHOUT LIMITATION, ANY IMPLIED WARRANTIES OF MERCHANTABILITY, FITNESS FOR A PARTICULAR PURPOSE, OR NON-INFRINGEMENT OF THIRD PARTY INTELLECTUAL PROPERTY RIGHTS.

These resources are intended for developers skilled in the art designing with Renesas products. You are solely responsible for (1) selecting the appropriate products for your application, (2) designing, validating, and testing your application, and (3) ensuring your application meets applicable standards, and any other safety, security, or other requirements. These resources are subject to change without notice. Renesas grants you permission to use these resources only for development of an application that uses Renesas products. Other reproduction or use of these resources is strictly prohibited. No license is granted to any other Renesas intellectual property or to any third party intellectual property. Renesas disclaims responsibility for, and you will fully indemnify Renesas and its representatives against, any claims, damages, costs, losses, or liabilities arising out of your use of these resources. Renesas' products are provided only subject to Renesas' Terms and Conditions of Sale or other applicable terms agreed to in writing. No use of any Renesas resources expands or otherwise alters any applicable warranties or warranty disclaimers for these products.

(Disclaimer Rev.1.0 Mar 2020)

Corporate Headquarters

TOYOSU FORESIA, 3-2-24 Toyosu,
Koto-ku, Tokyo 135-0061, Japan
www.renesas.com

Contact Information

For further information on a product, technology, the most up-to-date version of a document, or your nearest sales office, please visit:
www.renesas.com/contact/

Trademarks

Renesas and the Renesas logo are trademarks of Renesas Electronics Corporation. All trademarks and registered trademarks are the property of their respective owners.