

RAA214223

150mA 20V Wide Input Voltage Range LDO Linear Regulator with 3.3V Fixed Output

The RAA214223 is a low-dropout linear voltage regulator that operates with a wide input voltage range from 4V to 20V, and the device provides up to 150mA of output current at a fixed output voltage of 3.3V.

Featuring a wide input voltage range with excellent line and load regulation, the device also has integrated fault protection that includes over-temperature shutdown (OTSD) and short-circuit current limit.

The output voltage of the device is fixed at 3.3V, and the device does well with regulating both the over-temperature and the operating range of the input voltage and load. It is also stable with an MLCC output capacitor as low as 1µF.

The RAA214223 is available in the 5-pin TSOT23 package.

Features

- Wide input voltage range 4V to 20V
- Output current up to 150mA
- Low 3.6µA shutdown current
- Accurate output voltage (-1.75% / +2.5% over-temperature)
- Low dropout voltage: 240mV typical at 150mA load
- Excellent line and load regulation
- Stable with 1µF minimum MLCC output capacitor
- Integrated fault protections including thermal shutdown and current limit
- Available in the compact and cost effective TSOT23 package

Applications

- Battery-powered equipment
- MCU power supply
- Electric meters
- USB devices
- Laptop computers and tablets
- Portable modules and appliances

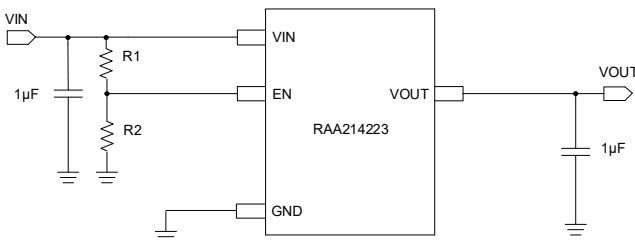

Figure 1. RAA214223 Typical Application (1)

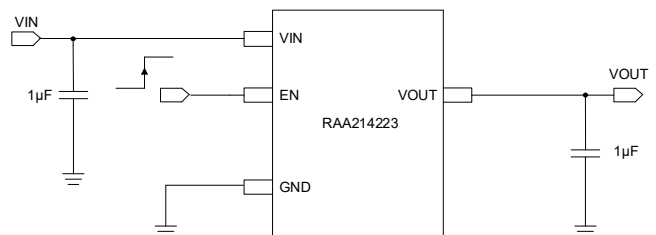

Figure 2. RAA214223 Typical Application (2)

Contents

1. Overview	3
1.1 Block Diagram	3
2. Pin Information	3
2.1 Pin Assignments	3
2.2 Pin Descriptions	3
3. Specifications	4
3.1 Absolute Maximum Ratings	4
3.2 Thermal Information	4
3.3 Recommended Operation Conditions	5
3.4 Electrical Specifications	5
4. Typical Performance Curves	6
5. Function Description	8
5.1 Function Overview	8
5.2 Enable Control	8
5.3 Current Limit Protection	8
5.4 Over-Temperature Shutdown (OTSD)	9
6. Application Information	9
6.1 Capacitor Selection	9
6.2 Power Dissipation	9
6.3 PCB Layout Recommendations	9
7. Package Outline Drawing	11
8. Ordering Information	12
9. Revision History	12

1. Overview

1.1 Block Diagram

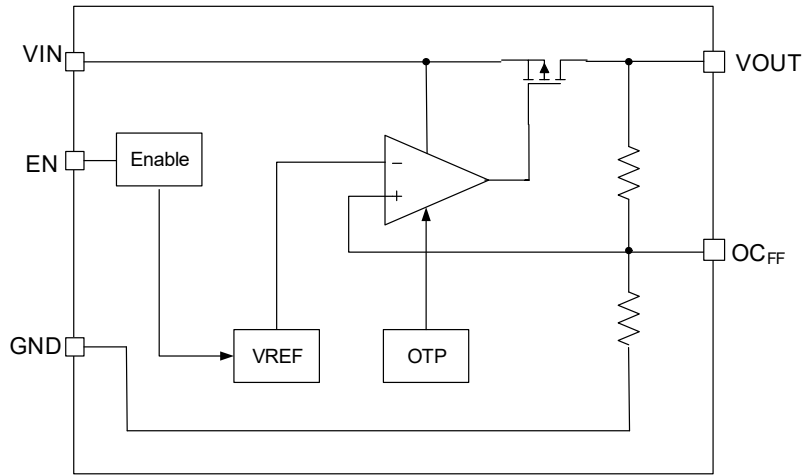
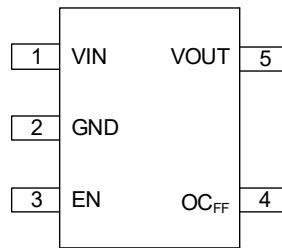

Figure 3. Block Diagram

2. Pin Information

2.1 Pin Assignments



Top View

2.2 Pin Descriptions

Pin Number	Pin Name	Description
VIN	1	Analog input supply voltage and positive supply for the linear regulator. Decouple this pin to ground with 0.1μF or larger high frequency ceramic capacitor to GND.
GND	2	Ground reference.
EN	3	Enable input. Drive EN high to turn on the linear regulator, low to turn it off. This pin can be connected to VIN directly or through a resistor divider for automatic turn on.
OC _{FF}	4	Optional C _{FF} pin. This pin does not need to be connected to any circuit. It does allow for an OPTIONAL feedforward capacitor to be placed between this pin and VOUT.
VOUT	5	3.3V output voltage pin. A minimum 1μF X5R/X7R output capacitor is required between this pin and GND. Place the capacitor as close to the output of the regulator as possible.

3. Specifications

3.1 Absolute Maximum Ratings

Caution: Do not operate at or near the maximum ratings listed for extended periods of time. Exposure to such conditions can adversely impact product reliability and result in failures not covered by warranty.

Parameter ^[1]	Minimum	Maximum	Unit
Supply Voltage, VIN	-0.3	+22	V
Enable Input Voltage, EN	-0.3	+22	V
Output Voltage, VOUT	-0.3	+22	V
OC _{FF} Pin Voltage	-0.3	+5.5	V
Output Current, IOUT	-	150	mA
Human Body Model (Tested per JS-001-2017)	-	3.5	kV
Charged Device Model (Tested per JS-002-2018)	-	1.5	kV
Latch-Up (Tested per JESD78E; Class 2, Level A)	-	100	mA

1. All voltages referenced to VSS unless otherwise specified.

3.2 Thermal Information

Parameter	Package	Symbol	Conditions	Typical Value	Unit
Thermal Resistance (Typical)	5-pin TSOT23	θ_{JA} ^[1]	Junction to air	215	°C/W
		θ_{JC} ^[2]	Junction to case	140	°C/W

1. θ_{JA} is measured in free air with the component mounted on a high-effective thermal conductivity test board with direct attach features. See [TB379](#).

2. For θ_{JC} , the case temperature location is on the top side of the package.

Parameter	Minimum	Maximum	Unit
Maximum Junction Temperature	-40	+150	°C
Maximum Storage Temperature Range	-65	+150	°C
Pb-Free Reflow Profile	see TB493		

3.3 Recommended Operation Conditions

Parameter	Minimum	Maximum	Unit
Supply Voltage, V_{IN}	+4	+20	V
Enable Input Voltage, EN	0	+20	V
Output Voltage, V_{OUT}	0	+3.3	V
Output Current, I_{OUT}	0	150	mA
Output Capacitor, C_{OUT}	1	200	μ F
Junction Temperature	-40	+125	$^{\circ}$ C

3.4 Electrical Specifications

At ambient temperature -40° C to $+125^{\circ}$ C, $I_{OUT} = 1$ mA, $C_{IN} = 1$ μ F, $C_{OUT} = 2.2$ μ F, $V_{IN} = 4.3$ V, EN = 5V, unless otherwise specified. Typical values are at $T_A = 25^{\circ}$ C.

Parameters	Symbol	Test Conditions	Min ^[1]	Typ	Max ^[1]	Unit
Input Voltage	V_{IN}	-	4	-	20	V
Output Voltage Accuracy	V_{OUT}	$V_{IN} = 4.3$ V to 20V, 25° C	-1.5	-	+2	%
		-40° C to 125° C	-1.75	-	+2.5	%
Line Regulation	$\frac{\Delta V_{OUT}\%}{\Delta V_{IN}}$	$V_{IN} = V_{OUT} + 1$ V to 20V	-	0.001	0.05	%/V
Load Regulation	$\frac{\Delta V_{OUT}\%}{\Delta I_{OUT}}$	$I_{OUT} = 100$ μ A to 150mA	-	0.003	0.01	%/mA
Dropout Voltage ^[2]	V_{DO}	$I_{OUT} = 10$ mA,	-	25	-	mV
		$I_{OUT} = 50$ mA	-	90	-	
		$I_{OUT} = 100$ mA	-	175	-	
		$I_{OUT} = 150$ mA	-	240	450	
Shutdown Current	I_{SHDN}	EN = 0, $V_{IN} = 4.5$ V	-	3.6	10	μ A
		EN = 0, $V_{IN} = 20$ V	-	5.2	-	
Ground Current	I_{GND}	$I_{OUT} = 0$	-	96	-	μ A
		$I_{OUT} = 10$ mA	-	147	-	
		$I_{OUT} = 100$ mA	-	176	-	
		$I_{OUT} = 150$ mA	-	190	275	
Power Supply Ripple Rejection	PSRR	f = 100Hz, $I_{OUT} = 10$ mA, $V_{IN} = 5$ V	-	86	-	dB
		f = 10kHz, $I_{OUT} = 10$ mA, $V_{IN} = 5$ V	-	65	-	dB
		f = 100kHz, $I_{OUT} = 10$ mA, $V_{IN} = 5$ V	-	34	-	dB
Output Voltage Noise	-	BW = 10Hz to 100kHz $I_{OUT} = 10$ mA, $V_{IN} = 5$ V	-	428	-	μ V _{RMS}
EN Rising Threshold	-	-	1.35	1.47	1.65	V
EN Falling Threshold	-	-	-	1.275	-	V

At ambient temperature -40°C to $+125^{\circ}\text{C}$, $I_{\text{OUT}} = 1\text{mA}$, $C_{\text{IN}} = 1\mu\text{F}$, $C_{\text{OUT}} = 2.2\mu\text{F}$, $V_{\text{IN}} = 4.3\text{V}$, $\text{EN} = 5\text{V}$, unless otherwise specified. Typical values are at $T_{\text{A}} = 25^{\circ}\text{C}$.

Parameters	Symbol	Test Conditions	Min ^[1]	Typ	Max ^[1]	Unit
EN Leakage Current	-	EN = 20V	-	0.8	2	μA
Short-Circuit Current Limit	-	-	160	220	275	mA
Thermal Shutdown	-	-	-	155	-	$^{\circ}\text{C}$
Hysteresis	-	-	-	22	-	$^{\circ}\text{C}$

- Parameters with MIN and/or MAX limits are 100% tested at $+25^{\circ}\text{C}$, unless otherwise specified. Temperature limits established by characterization and are not production tested.
- Dropout voltage is the input-to-output voltage difference at which the output voltage is 100mV below its normal value.

4. Typical Performance Curves

$C_{\text{IN}} = 1\mu\text{F}$, $C_{\text{OUT}} = 2.2\mu\text{F}$, $V_{\text{IN}} = 4.3\text{V}$, $T_{\text{A}} = +25^{\circ}\text{C}$, unless otherwise stated.

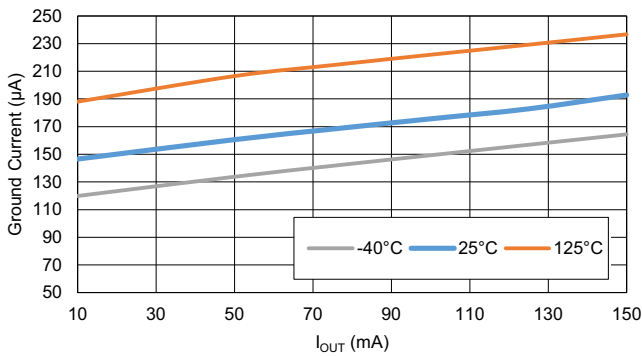

Figure 4. Ground Current vs Load Current

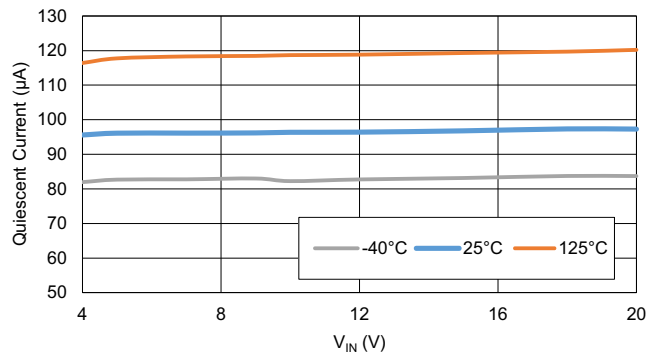

Figure 5. Quiescent Current (No Load) vs Input Voltage

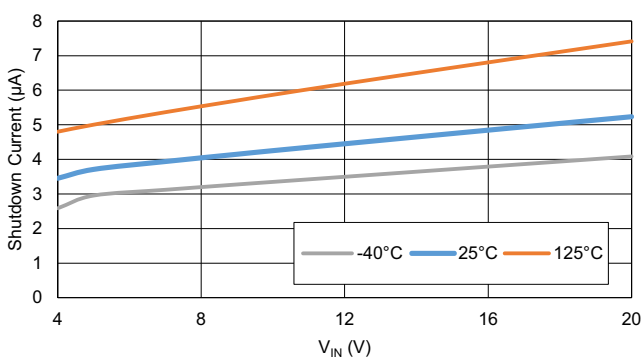

Figure 6. Shutdown Current (EN = 0) vs Input Voltage

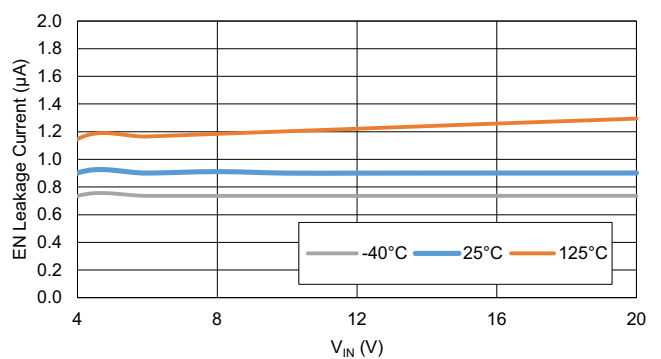

Figure 7. EN Leakage Current vs Temperature

$C_{IN} = 1\mu F$, $C_{OUT} = 2.2\mu F$, $V_{IN} = 4.3V$, $T_A = +25^\circ C$, unless otherwise stated. (Cont.)

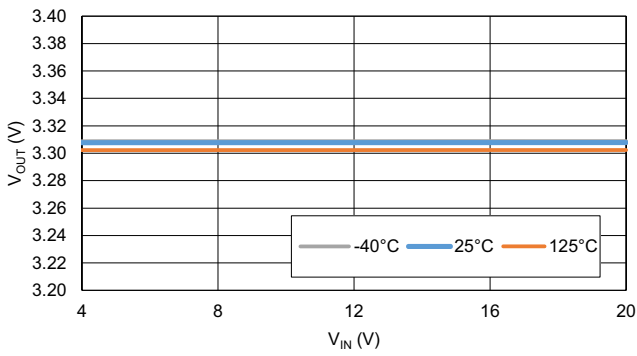

Figure 8. Output Voltage vs Input Voltage ($I_{OUT} = 1mA$)

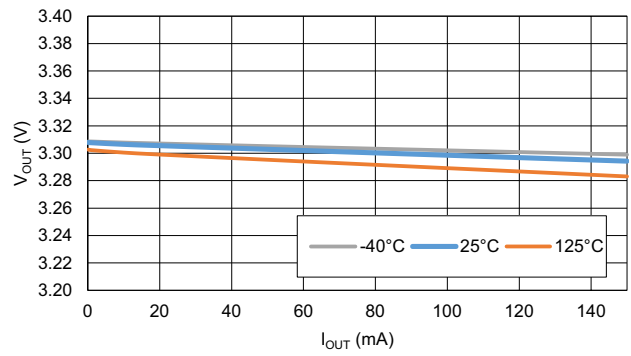

Figure 9. Output Voltage vs Load

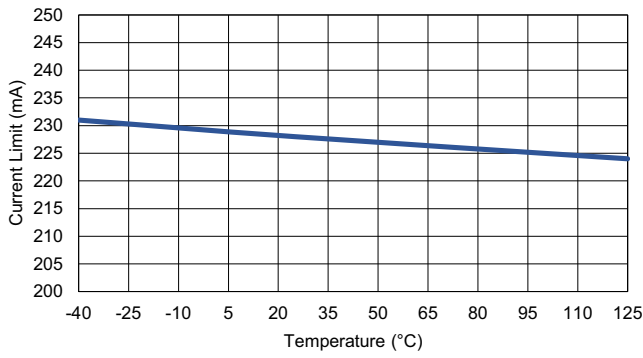

Figure 10. Current Limit vs Temperature

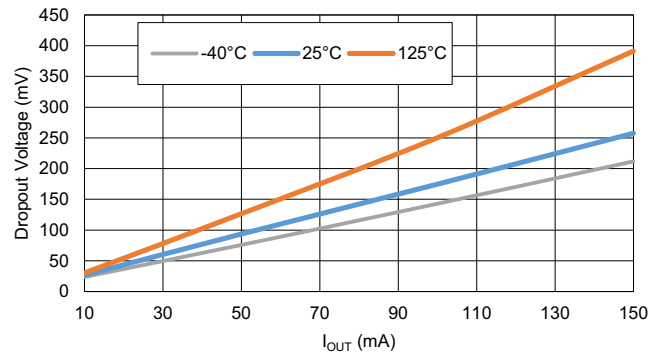

Figure 11. Dropout Voltage vs Load

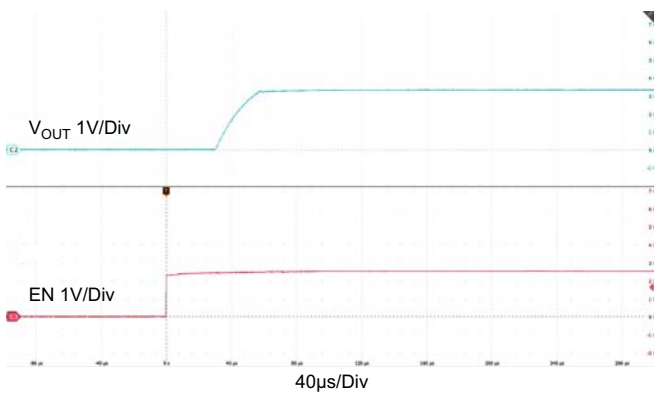

Figure 12. Startup with EN ($I_{OUT} = 150mA$)

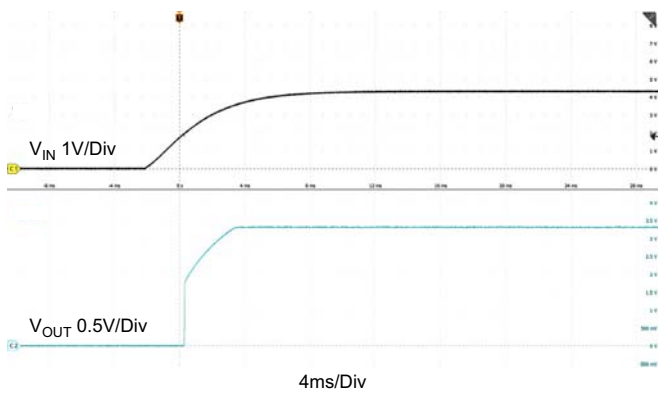

Figure 13. Startup with VIN ($I_{OUT} = 150mA$)

$C_{IN} = 1\mu F$, $C_{OUT} = 2.2\mu F$, $V_{IN} = 4.3V$, $T_A = +25^\circ C$, unless otherwise stated. (Cont.)

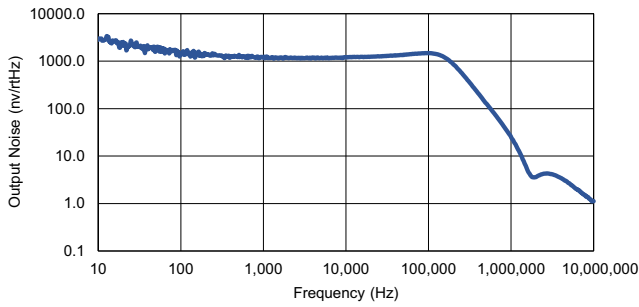

Figure 14. Output Noise Spectral Density ($V_{IN} = 5V$, $I_{OUT} = 10mA$)

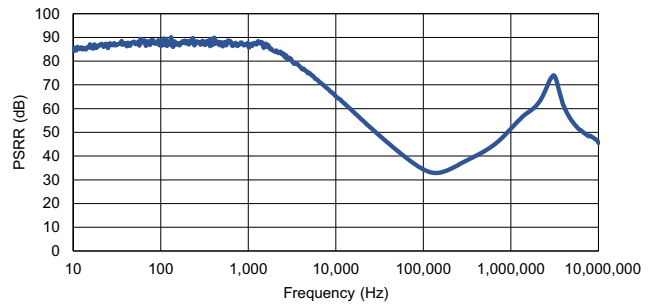

Figure 15. PSRR ($V_{IN} = 5V$, $I_{OUT} = 10mA$)

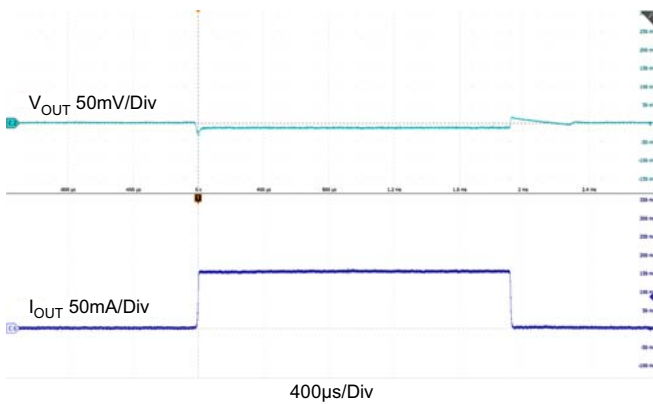

Figure 16. Load Transient (0 to 150mA, $C_{OUT} = 1\mu F$)

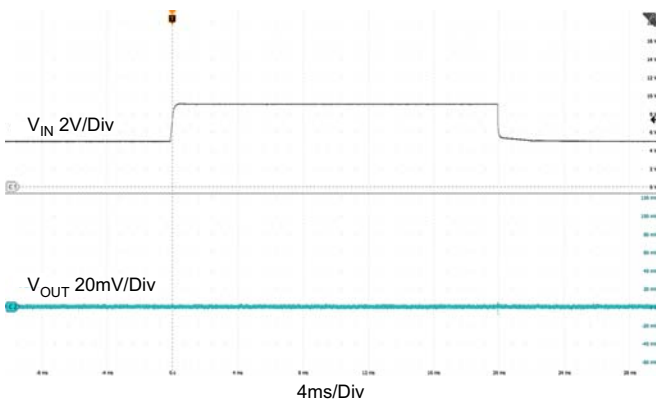

Figure 17. Line Transient (5V to 12V, $C_{OUT} = 1\mu F$, $I_{OUT} = 10mA$)

5. Function Description

5.1 Function Overview

The RAA214223 is a high-performance low-dropout linear voltage regulator with 150mA sourcing capability. It operates at an input voltage range of 4V to 20V and has a fixed output voltage of 3.3V.

5.2 Enable Control

The RAA214223 has an enable pin that turns the device on when pulled high. When EN is low, the IC enters shutdown mode and draws 3.6µA of current. To prevent shutdown and keep the device operating, tie the EN pin directly to VIN. The RAA214223 has an accurate and stable Enable threshold that allows you to program the Enable voltage through a resistor divider.

5.3 Current Limit Protection

The RAA214223 has internal current limiting functionality to protect the regulator during fault conditions. During the current limit, the output sources a fixed amount of current largely independent of the output voltage. If the short or overload is removed from VOUT, the output returns to normal voltage regulation mode.

5.4 Over-Temperature Shutdown (OTSD)

If the die temperature exceeds the over-temperature threshold of the device, the output of the LDO shuts down until the die temperature cools down to a temperature determined by the hysteresis of the OTSD. The level of power that dissipates, combined with the ambient temperature and the thermal impedance of the package, determines if the junction temperature exceeds the OTSD temperature.

6. Application Information

6.1 Capacitor Selection

Renesas recommends connecting a 1µF ceramic capacitor between VIN and GND at the input to reduce circuit sensitivity to the PCB layout. At a minimum, place a 0.1µF ceramic capacitor close to the input pin for noise decoupling. Higher capacitance improves the line transient response.

The device is stable with a minimum of 1µF output capacitor. An optional ceramic capacitor of 10-22pF between the VOUT and OC_{FF} pins can be used to improve overshoot or undershoot in startup or transient situations, although it is not required. This cap may also help improve PSRR at certain frequencies.

For both the input and output capacitors, and the optional C_{FF}, Renesas recommends the X7R type because it has a low capacitance variation over-temperature.

6.2 Power Dissipation

The junction temperature must not exceed the range specified in [Recommended Operation Conditions](#). The power dissipation is calculated using [Equation 1](#).

$$(EQ. 1) \quad P_D = (V_{IN} - V_{OUT}) \times I_{OUT} + V_{IN} \times I_{GND}$$

To calculate the maximum ambient operating temperature, use the junction-to-ambient thermal resistance (θ_{JA}) as shown in [Equation 2](#), where $T_{J(MAX)}$ is the maximum allowable junction temperature, and T_A is the ambient temperature.

$$(EQ. 2) \quad T_{J(MAX)} = P_{D(MAX)} \times \theta_{JA} + T_A$$

For any target junction temperature and output voltage, the maximum load that the IC allows decreases as the supply voltage increases. Given the thermal resistance θ_{JA} , use [Equation 1](#) and [Equation 2](#) to estimate the maximum load the IC supports up to its maximum junction temperature. The lower θ_{JA} is, the more load the device can handle. To lower θ_{JA} , a large trace metal area, and ground plane should be applied on the PCB.

6.3 PCB Layout Recommendations

When placing components and routing the trace, minimize the ground impedance and keep the parasitic inductance low. Place the input and output capacitors as close to the IC as possible. The optional feedforward capacitor can be placed between the IC and the output capacitor, but only a small 0402 or 0603 package is needed. VIN, VOUT, and GND traces should be reasonably wide to improve the thermal performance of the IC and to reduce the chance of noise pickup.

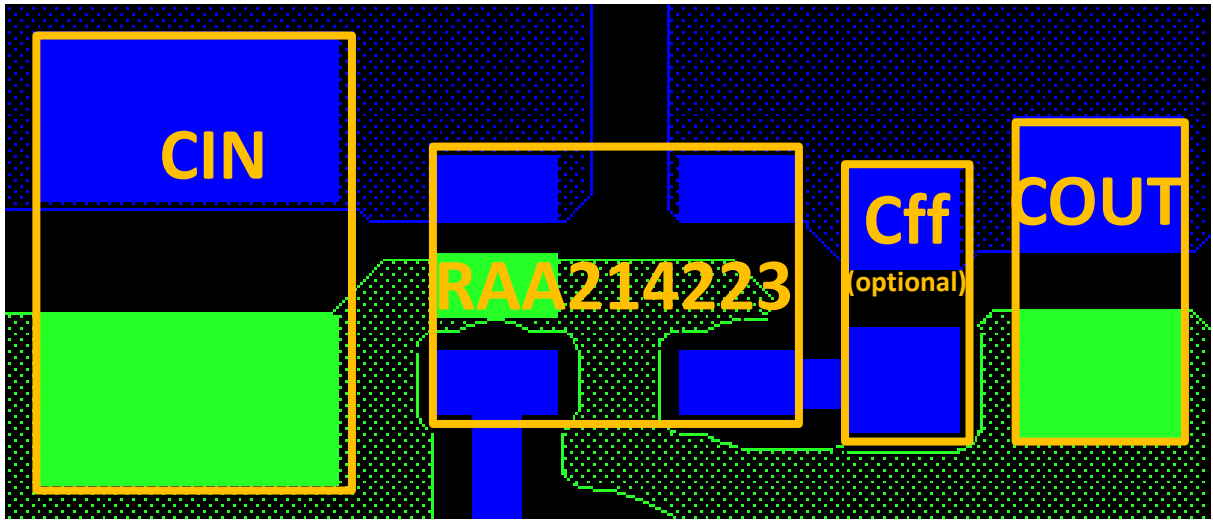
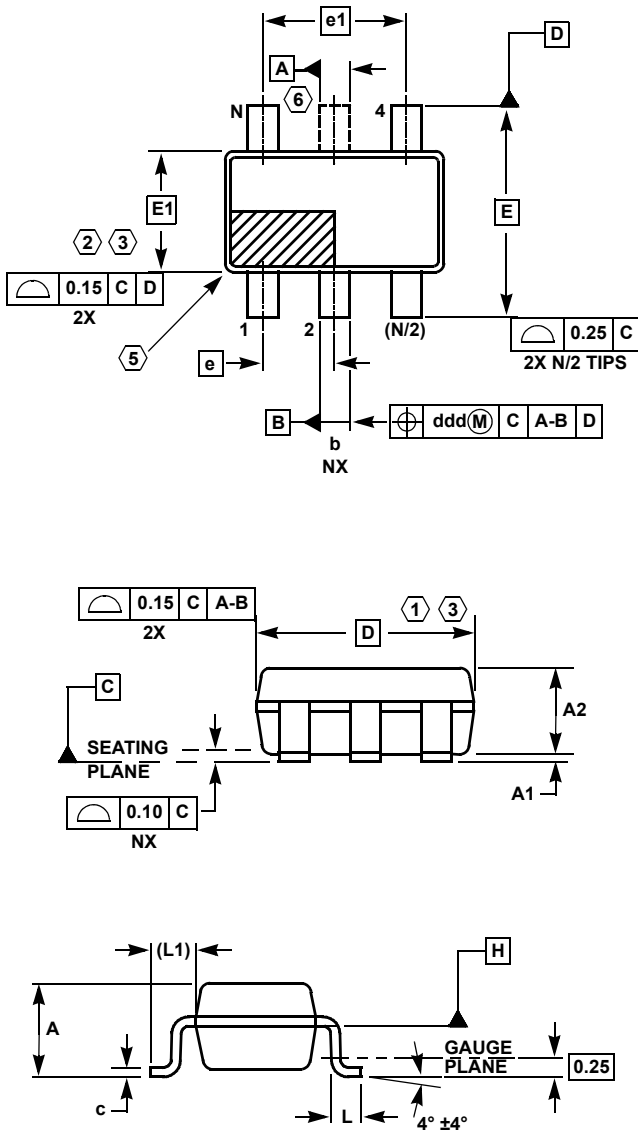

Figure 18. Recommended Component Placement

7. Package Outline Drawing

TSOT Package Family



MDP0049 TSOT PACKAGE FAMILY

SYMBOL	MILLIMETERS			TOLERANCE
	TSOT5	TSOT6	TSOT8	
A	1.00	1.00	1.00	Max
A1	0.05	0.05	0.05	±0.05
A2	0.87	0.87	0.87	±0.03
b	0.38	0.38	0.29	±0.07
c	0.127	0.127	0.127	+0.07/-0.007
D	2.90	2.90	2.90	Basic
E	2.80	2.80	2.80	Basic
E1	1.60	1.60	1.60	Basic
e	0.95	0.95	0.65	Basic
e1	1.90	1.90	1.95	Basic
L	0.40	0.40	0.40	±0.10
L1	0.60	0.60	0.60	Reference
ddd	0.20	0.20	0.13	-
N	5	6	8	Reference

Rev. B 2/07

NOTES:

1. Plastic or metal protrusions of 0.15mm maximum per side are not included.
2. Plastic interlead protrusions of 0.15mm maximum per side are not included.
3. This dimension is measured at Datum Plane "H".
4. Dimensioning and tolerancing per ASME Y14.5M-1994.
5. Index area - Pin #1 I.D. will be located within the indicated zone (TSOT6 AND TSOT8 only).
6. TSOT5 version has no center lead (shown as a dashed line).

8. Ordering Information

Part Number ^{[1][2]}	Part Marking ^[3]	Package Description (RoHS Compliant)	Pkg. Dwg. #	Carrier Type ^[4]	Temp Range
RAA2142234GP3#JA0	223	5-pin TSOT23	MDP0049	Reel, 3k	-40°C to 125°C

1. These Pb-free plastic packaged products employ special Pb-free material sets, molding compounds/die attach materials, and 100% matte tin plate plus anneal (e3 termination finish, which is RoHS compliant and compatible with both SnPb and Pb-free soldering operations). Pb-free products are MSL classified at Pb-free peak reflow temperatures that meet or exceed the Pb-free requirements of IPC/JEDEC J STD-020.
2. For Moisture Sensitivity Level (MSL), see the [RAA214223](#) product page. For more information about MSL, see [TB363](#).
3. The part marking is located on the bottom of the part.
4. See [TB347](#) for details about reel specifications.

9. Revision History

Revision	Date	Description
1.00	Jun 9, 2023	Initial release.

IMPORTANT NOTICE AND DISCLAIMER

RENESAS ELECTRONICS CORPORATION AND ITS SUBSIDIARIES (“RENESAS”) PROVIDES TECHNICAL SPECIFICATIONS AND RELIABILITY DATA (INCLUDING DATASHEETS), DESIGN RESOURCES (INCLUDING REFERENCE DESIGNS), APPLICATION OR OTHER DESIGN ADVICE, WEB TOOLS, SAFETY INFORMATION, AND OTHER RESOURCES “AS IS” AND WITH ALL FAULTS, AND DISCLAIMS ALL WARRANTIES, EXPRESS OR IMPLIED, INCLUDING, WITHOUT LIMITATION, ANY IMPLIED WARRANTIES OF MERCHANTABILITY, FITNESS FOR A PARTICULAR PURPOSE, OR NON-INFRINGEMENT OF THIRD PARTY INTELLECTUAL PROPERTY RIGHTS.

These resources are intended for developers skilled in the art designing with Renesas products. You are solely responsible for (1) selecting the appropriate products for your application, (2) designing, validating, and testing your application, and (3) ensuring your application meets applicable standards, and any other safety, security, or other requirements. These resources are subject to change without notice. Renesas grants you permission to use these resources only for development of an application that uses Renesas products. Other reproduction or use of these resources is strictly prohibited. No license is granted to any other Renesas intellectual property or to any third party intellectual property. Renesas disclaims responsibility for, and you will fully indemnify Renesas and its representatives against, any claims, damages, costs, losses, or liabilities arising out of your use of these resources. Renesas' products are provided only subject to Renesas' Terms and Conditions of Sale or other applicable terms agreed to in writing. No use of any Renesas resources expands or otherwise alters any applicable warranties or warranty disclaimers for these products.

(Disclaimer Rev.1.0 Mar 2020)

Corporate Headquarters

TOYOSU FORESIA, 3-2-24 Toyosu,
Koto-ku, Tokyo 135-0061, Japan
www.renesas.com

Contact Information

For further information on a product, technology, the most up-to-date version of a document, or your nearest sales office, please visit:
www.renesas.com/contact/

Trademarks

Renesas and the Renesas logo are trademarks of Renesas Electronics Corporation. All trademarks and registered trademarks are the property of their respective owners.