

## VersaClock 7 Setup Process for RCTIMING-DEMO Timing Solution

This guide provides detailed instructions for setting up and utilizing the RCTIMING-DEMO timing solution.

### Contents

<b>1. Introduction</b> .....	<b>2</b>
<b>2. Targeted Devices</b> .....	<b>2</b>
<b>3. Kit Contents</b> .....	<b>2</b>
3.1 Hardware Components.....	2
3.2 Software Components .....	3
<b>4. Features</b> .....	<b>3</b>
4.1 Operation Image.....	4
<b>5. Setting Up the Demo</b> .....	<b>4</b>
5.1 Download Code to RL78/L13.....	4
5.2 Download Code to DA14531MOD.....	4
5.3 Download Code to EEPROM.....	4
5.4 Install iOS / Android App.....	4
<b>6. Running the Demo</b> .....	<b>5</b>
6.1 IAQ and RTC Mode .....	5
6.2 Clocks Output Mode .....	5
6.3 Using Renesas SmartConsole to Send the Target Data .....	7
6.4 Using Serial Debugging Tool on PC to Set the Target Data.....	10
6.5 Format Types and Settings for VC7 Frequency and RTC .....	10
6.5.1 Setting the Output Clock Frequency of VC7.....	10
6.5.2 Setting the Output Mode of VC7.....	10
6.5.3 Setting the Hour and Minute Value of RTC .....	11
<b>7. References</b> .....	<b>11</b>
<b>8. Revision History</b> .....	<b>12</b>

### Figures

Figure 1. System Block Diagram .....	3
Figure 2. Operation Image.....	4
Figure 3. LCD Display in IAQ and RTC Mode .....	5
Figure 4. Channel 0 Display of VC7 Clocks Output Mode.....	5
Figure 5. Channel 1 Display of VC7 Clocks Output Mode .....	6
Figure 6. SmartConsole Icon on Android and iOS Device.....	7
Figure 7. SPS_531 Device Icon .....	7
Figure 8. List Menu – Read/transfer Data.....	8
Figure 9. Send Console Mode Text Box.....	9

Figure 10. Enter the Target Clock Frequency.....	9
Figure 11. Commix Configuration Interface.....	10

## 1. Introduction

This guide explains the process of utilizing the VersaClock® 7 (VC7) chip ([RC21008](#)) to calculate and configure the desired clock frequency. Additionally, it outlines the procedure for switching the output mode between LP-HCSL and LVCMOS for the two clock channels. Furthermore, clock values can be adjusted based on the target frequency received from either a PC via a UART-USB bridge or a mobile phone through the [DA14531 BLE](#) chip. When not actively outputting clocks, the system allows for indoor air quality monitoring using the [ZMOD4410](#) gas sensor and obtaining the current time from the real-time clock chip.

The highlighted device in this demonstration is the VC7, a programmable clock generator that can deliver outstanding performance, with maximum LP-HCSL output of 650MHz and LVCMOS output of 200MHz.

## 2. Targeted Devices

- VersaClock 7 Programmable Clock Generator Family: RC21008
- Main controller: RL78/L13 MCU with LCD controller
- Bluetooth Low Energy module: DA14531MOD
- Indoor air quality sensor: ZMOD4410
- Real-Time Clock with battery backed non-volatile RAM: 1338
- 16-Kbit EEPROM

## 3. Kit Contents

### 3.1 Hardware Components

The following hardware components are required for the setup of this demo:

- RL78/L13 chip with serial interface I<sup>2</sup>C, serial array unit, timer array unit, and LCD controller/driver
- RC21008 – a high-performance programmable clock generator for compute, data-communications, and industrial applications
- DA14531MOD – a Bluetooth Low Energy module for receiving data from mobile phone
- USB to UART bridge for receiving data from PC
- ZMOD4410 – a firmware configurable indoor air quality (IAQ) sensor with embedded artificial intelligence (AI)
- 1338 – a serial real-time clock device that consumes ultra-low power
- 24FC16 – a 16-Kbit electrically erasable PROM (EEPROM) for saving startup configuration file of VC7
- A dedicated LCD panel used for displaying screens running in two different modes, one is for indoor air quality and real-time clock monitoring, the other is two channels of VC7 clock frequency output
- USB cable

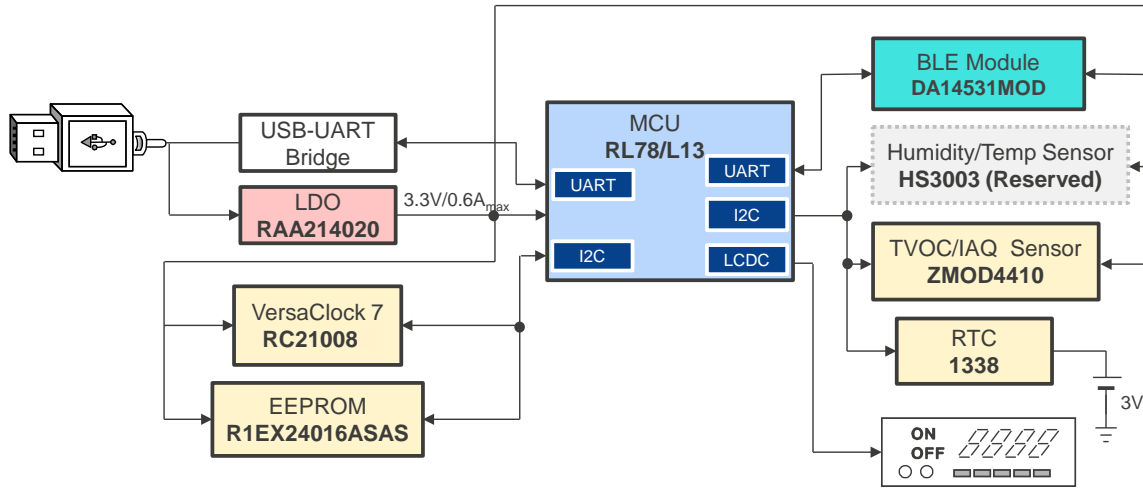

Figure 1. System Block Diagram

### 3.2 Software Components

The following software components are required for the setup of this demo:

Category		Item	Comment
MCU	Firmware	CN369_Timing_Solution_RL78L13_V100.mot	Needs to be downloaded to RL78/L13 MCU.
	Software	Renesas Flash Programmer	A tool to program the firmware to MCU.
DA14531 Module	Image	dsps_device_531_multi.bin	For DA14531 SmartBond TINY™ Module.
	Software	SmartBond™ Flash Programmer	A tool to program the DSPS firmware to DA14531MOD.
EEPROM	Image	RC21008__SST_CN369_V1.0.rbs	Store device configuration file for VC7 clock chip starting up.
	Software	RICBox	A tool to download configuration file for VC7 starting up to EEPROM.
Mobile App	Android or iOS application	Renesas SmartControl for iOS or Renesas SmartControl for Android	An app for sending the target frequency, output mode, and real time to the solution board.
PC App	Commix.exe	Serial debugging tool	

### 4. Features

- Ability to configure two channels of VC7 output frequency and two channels of VC7 output mode by PC or mobile phone at VC7 clocks output mode. The output mode switches between LP-HCSL and LVCMOS.
- Adjustable hour and minute of real-time clock (RTC) by PC or mobile phone at IAQ and RTC mode.
- Provides two screens in two modes: one is for indoor air quality and real-time monitoring mode and the other is for VC7 clocks output mode. The refresh time for each mode is 3 seconds.

## 4.1 Operation Image

This demo utilizes two configurable channels of clock output and an adjustable real-time clock. It can also be used as a tool for monitoring the indoor air quality.

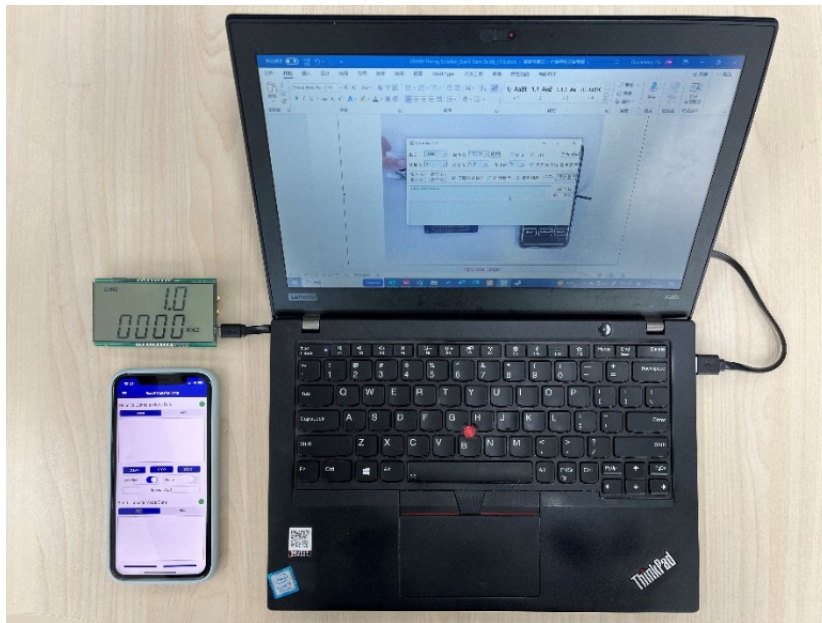

Figure 2. Operation Image

## 5. Setting Up the Demo

### 5.1 Download Code to RL78/L13

The solution board provides a 4-pin interface for RL78 Core programming and debugging, which includes Tool0, Reset, VCC and GND. The Renesas E1 and conversion board are used as a debugging tool.

The target code has been downloaded into RL78/L13 prior to shipment.

### 5.2 Download Code to DA14531MOD

The solution board provides an 8-pin interface for I<sup>2</sup>C debugging and DA14531 programming. Using the SWDIO, SWCLK, VCC and GND to connect related pins of J-Link debugger realizes DA14531 serial programming, cooperating with Dialog SmartBond Flash Programmer GUI.

For more information on programming the DA14531, see [SmartBond™ Flash Programmer](#).

### 5.3 Download Code to EEPROM

The solution board provides a chip carrier socket of EEPROM for installing an externally pre-programmed chip. The EEPROM ought to be programmed in advance by the VC7 EVK using the Renesas IC Toolbox (RICBox) software as the entity keeping the configuration file for VC7 chip start-up.

All EEPROMs in the board have been programmed prior to shipment.

### 5.4 Install iOS / Android App

The Dialog Serial Port Service (DSPA) reference application comes with an SPS demo application for Android and iOS systems. The Renesas SmartConsole application can discover, connect and exchange data with SPS-enabled devices within the Bluetooth RF range of the mobile device.

In this solution, software of Renesas SmartConsole on iOS or Android is used for a tool to control clock output frequency of VC7 and set the current time to RTC.

For more information on the SmartConsole, download the [UM-B-088: DA145x User Manual for Dialog Serial Port Service](#) document from the Renesas website.

## 6. Running the Demo

### 6.1 IAQ and RTC Mode

Provide power to the solution board via the USB connector to monitor the display on the LCD. In IAQ and RTC mode, the following figure shows the initial status of the board after it's powered on by plugging-in micro-USB cable.



Figure 3. LCD Display in IAQ and RTC Mode

In this mode, only one screen of indoor air quality value, and hour and minute of real-time clock is displayed. The default value of IAQ is 0. The default value of RTC is 12:20 when no coin battery is present. VC7 is powered down at this time to ensure whole board consumption is reduced. The data displayed refreshes every 3 seconds.

RTC value can be set by a PC or mobile phone. The time continues counting from this new set when a coin battery is installed.

### 6.2 Clocks Output Mode

In VC7 clocks output mode, a VC7 device is powered on and two channels of frequency output mode are available.

Press the S1 key at the bottom-left corner of the board to power up the VC7 chip. The display switches to VC7 clocks output mode. The default output frequency of two channels is 100MHz and the default output mode is LP-HCSL. The two displays alternate every 3 seconds from channel 0.

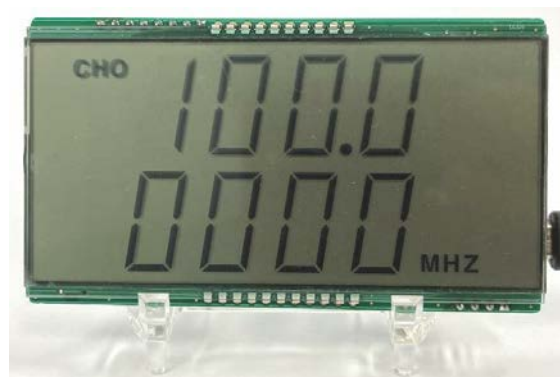

Figure 4. Channel 0 Display of VC7 Clocks Output Mode

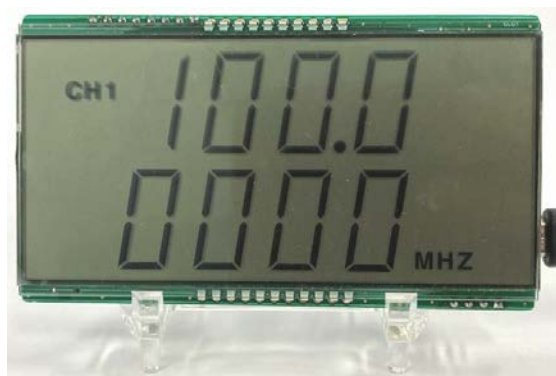

Figure 5. Channel 1 Display of VC7 Clocks Output Mode

The output frequency changes according to the frequency set by the PC or mobile phone.

*Note:* When the output mode of VC7 is changed from LP-HCSL to LVCMOS or from LVCMOS to LP-HCSL, nothing changes on the display – only the relative register of VC7 has been modified.

Pressing the S1 key again returns the program to IAQ and RTC mode, and the VC7 device is powered down again.

### 6.3 Using Renesas SmartConsole to Send the Target Data

1. Open the SmartConsole App on your iOS or Android mobile phone. Tap the *SmartConsole* icon to start the application.



Figure 6. SmartConsole Icon on Android and iOS Device

2. Slide down to find device named *SPS\_531* (see Figure 7). Tap on this name to connect to the device.



Figure 7. SPS\_531 Device Icon

3. Tap the List Menu icon on the left upper corner of the screen and select the second operation mode – *Read/Transfer Data* (see Figure 8).

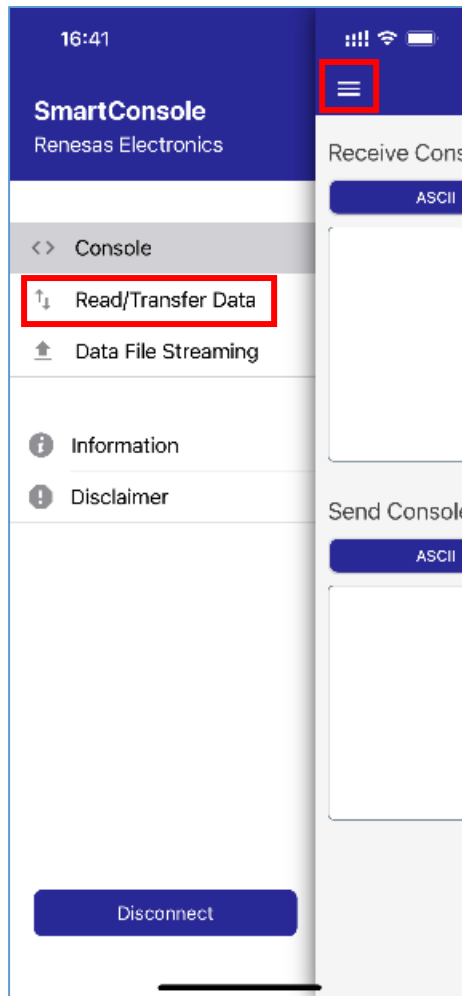

Figure 8. List Menu – Read/transfer Data



4. Use the text box named *Send Console Mode Data* at the bottom of the screen (see Figure 9) to send data to the specified DA14531MOD via the keyboard tapping.

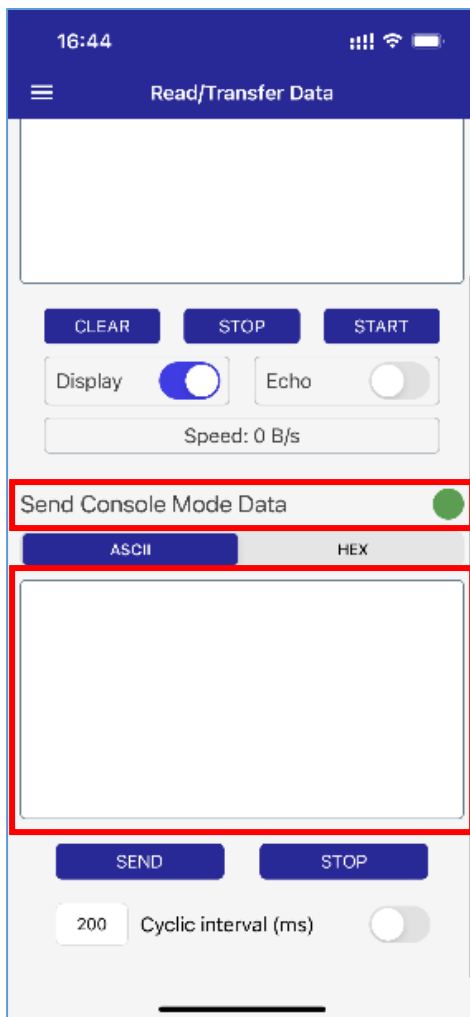

Figure 9. Send Console Mode Text Box

5. Type the target clock frequency or real-time clock via keyboard (see Figure 10) and click *Send*. The clock frequency of this specified channel is changed and output to the LCD.

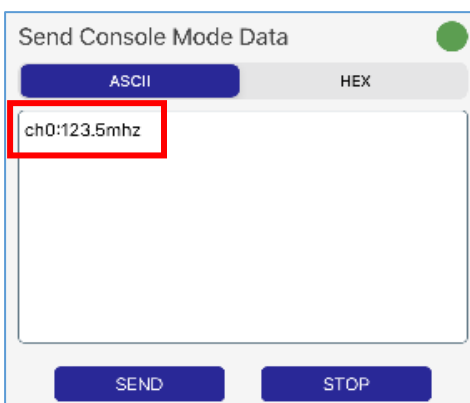

Figure 10. Enter the Target Clock Frequency

## 6.4 Using Serial Debugging Tool on PC to Set the Target Data

The USB cable connected to the PC not only provides power to the board, but also functions as a serial debugging cable.

The PC software named “Commix” can be used as a serial debugging tool to send the target clock frequency and real-time to the solution board by a PC. Figure 11 shows the configuration interface after Commix is opened.

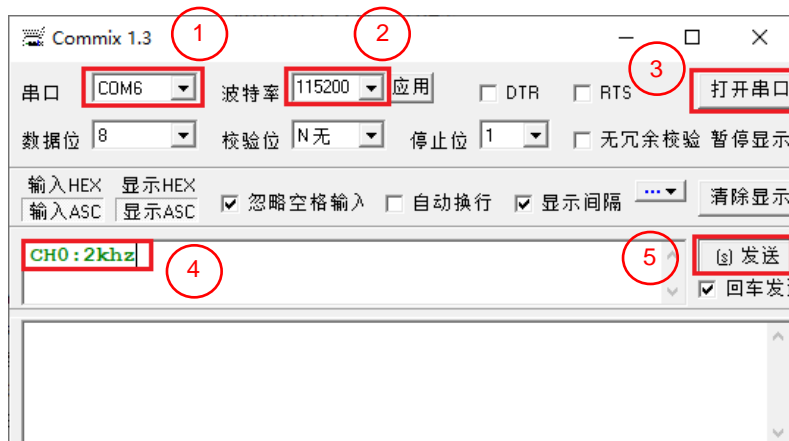

Figure 11. Commix Configuration Interface

1. Find the dedicated serial port assigned to the solution board on the PC, then select it in the serial port box of Commix.
2. Set the baud rate as 115200bps.
3. Click “open the serial port” to establish a connection between the PC and the solution board.
4. Input the desired clock frequency.
5. Click “transmit” button to send it to the solution board.

The clock frequency of this specified channel is changed and output to the LCD.

## 6.5 Format Types and Settings for VC7 Frequency and RTC

The three format types for setting the target frequency and real-time clock are shown below.

### 6.5.1 Setting the Output Clock Frequency of VC7

ch + channel number + : + frequency value + unit.

Example:

ch0:123.45678kHz, ch0: 1kHz, ch1:320.42MHz, ch1:1MHz

Notes:

1. Only ch0 and ch1 can be recognized as the channel setting. The number of channels must follow the channel name.
2. The units can be identified as MHz and kHz.
3. The inputs are case insensitive. The maximum number of decimal places is 5.
4. If the wrong format or frequency value is entered, “input error!” will return.
5. Frequency setting only works in VC7 clocks output mode. If frequency is set in IAQ and RTC mode, “display mode err!” will return.

### 6.5.2 Setting the Output Mode of VC7

ch + channel number + : + hcsl or lvcmos

Example:

```
ch0:hcs1 or ch1:lvcmos
```

Notes:

1. Only ch0 and ch1 can be recognized as the channel setting. The number of channels must follow the channel name.
2. The inputs are case insensitive. Only LVCMOS and LP-HCSL are supported.
3. If the wrong format or frequency value is entered, "input error!" will return.
4. The default output of all channels is LP-HCSL (100Ω).
5. LVCMOS is set when LVCMOS is sending.
6. There is no display change when output mode is set. The updated output mode can be confirmed by other devices such as an oscilloscope.
7. Mode change only works in VC7 clocks output mode.

### 6.5.3 Setting the Hour and Minute Value of RTC

```
rtc + : + hour + minute
```

Example:

```
rtc:1:23, or rtc:12:05.
```

Notes:

1. There are two colons in this command.
2. The inputs are case insensitive. The hour range is from 00 to 23 and minute range is from 00 to 59.
3. If the wrong format is entered, "input error!" will return.
4. Only the hour and minute can be set in the solution board. Other time related parameters (such as year, month) can not be set.
5. RTC setting only works in IAQ and RTC mode.

## 7. References

[RC210 – VersaClock® 7 Programmable Clock Generator Family](#)

[RL78/L13 – Standard LCD Microcontrollers with Low Power Consumption, Suitable for LCD Display of Home Appliances or Measurement Devices](#)

[DA14531MOD – SmartBond TINY™ Bluetooth® Low Energy Module](#)

[ZMOD4410 – Firmware Configurable Indoor Air Quality \(IAQ\) Sensor with Embedded Artificial Intelligence \(AI\)](#)

For additional technical information, updates, or support, please visit the [Renesas](#) website.

## 8. Revision History

Revision	Date	Description
1.00	Jun 27, 2023	Initial release.

## IMPORTANT NOTICE AND DISCLAIMER

RENESAS ELECTRONICS CORPORATION AND ITS SUBSIDIARIES (“RENESAS”) PROVIDES TECHNICAL SPECIFICATIONS AND RELIABILITY DATA (INCLUDING DATASHEETS), DESIGN RESOURCES (INCLUDING REFERENCE DESIGNS), APPLICATION OR OTHER DESIGN ADVICE, WEB TOOLS, SAFETY INFORMATION, AND OTHER RESOURCES “AS IS” AND WITH ALL FAULTS, AND DISCLAIMS ALL WARRANTIES, EXPRESS OR IMPLIED, INCLUDING, WITHOUT LIMITATION, ANY IMPLIED WARRANTIES OF MERCHANTABILITY, FITNESS FOR A PARTICULAR PURPOSE, OR NON-INFRINGEMENT OF THIRD-PARTY INTELLECTUAL PROPERTY RIGHTS.

These resources are intended for developers who are designing with Renesas products. You are solely responsible for (1) selecting the appropriate products for your application, (2) designing, validating, and testing your application, and (3) ensuring your application meets applicable standards, and any other safety, security, or other requirements. These resources are subject to change without notice. Renesas grants you permission to use these resources only to develop an application that uses Renesas products. Other reproduction or use of these resources is strictly prohibited. No license is granted to any other Renesas intellectual property or to any third-party intellectual property. Renesas disclaims responsibility for, and you will fully indemnify Renesas and its representatives against, any claims, damages, costs, losses, or liabilities arising from your use of these resources. Renesas' products are provided only subject to Renesas' Terms and Conditions of Sale or other applicable terms agreed to in writing. No use of any Renesas resources expands or otherwise alters any applicable warranties or warranty disclaimers for these products.

(Disclaimer Rev.1.01 Jan 2024)

### Corporate Headquarters

TOYOSU FORESIA, 3-2-24 Toyosu,  
Koto-ku, Tokyo 135-0061, Japan  
[www.renesas.com](http://www.renesas.com)

### Trademarks

Renesas and the Renesas logo are trademarks of Renesas Electronics Corporation. All trademarks and registered trademarks are the property of their respective owners.

### Contact Information

For further information on a product, technology, the most up-to-date version of a document, or your nearest sales office, please visit [www.renesas.com/contact-us/](http://www.renesas.com/contact-us/).