

# EEPROM Emulation Library

16

Type T01, European Release

16 Bit Single-chip Microcontroller  
RL78 Family

Installer: RENESAS\_RL78\_EEL-FDL\_T01\_PACK01\_xVxx

All information contained in these materials, including products and product specifications, represents information on the product at the time of publication and is subject to change by Renesas Electronics Corp. without notice. Please review the latest information published by Renesas Electronics Corp. through various means, including the Renesas Technology Corp. website (<http://www.renesas.com>).

## Notice

1. Descriptions of circuits, software and other related information in this document are provided only to illustrate the operation of semiconductor products and application examples. You are fully responsible for the incorporation or any other use of the circuits, software, and information in the design of your product or system. Renesas Electronics disclaims any and all liability for any losses and damages incurred by you or third parties arising from the use of these circuits, software, or information.
2. Renesas Electronics hereby expressly disclaims any warranties against and liability for infringement or any other claims involving patents, copyrights, or other intellectual property rights of third parties, by or arising from the use of Renesas Electronics products or technical information described in this document, including but not limited to, the product data, drawings, charts, programs, algorithms, and application examples.
3. No license, express, implied or otherwise, is granted hereby under any patents, copyrights or other intellectual property rights of Renesas Electronics or others.
4. You shall not alter, modify, copy, or reverse engineer any Renesas Electronics product, whether in whole or in part. Renesas Electronics disclaims any and all liability for any losses or damages incurred by you or third parties arising from such alteration, modification, copying or reverse engineering.
5. Renesas Electronics products are classified according to the following two quality grades: "Standard" and "High Quality". The intended applications for each Renesas Electronics product depends on the product's quality grade, as indicated below.  
"Standard": Computers; office equipment; communications equipment; test and measurement equipment; audio and visual equipment; home electronic appliances; machine tools; personal electronic equipment; industrial robots; etc.  
"High Quality": Transportation equipment (automobiles, trains, ships, etc.); traffic control (traffic lights); large-scale communication equipment; key financial terminal systems; safety control equipment; etc.  
Unless expressly designated as a high reliability product or a product for harsh environments in a Renesas Electronics data sheet or other Renesas Electronics document, Renesas Electronics products are not intended or authorized for use in products or systems that may pose a direct threat to human life or bodily injury (artificial life support devices or systems; surgical implantations; etc.), or may cause serious property damage (space system; undersea repeaters; nuclear power control systems; aircraft control systems; key plant systems; military equipment; etc.). Renesas Electronics disclaims any and all liability for any damages or losses incurred by you or any third parties arising from the use of any Renesas Electronics product that is inconsistent with any Renesas Electronics data sheet, user's manual or other Renesas Electronics document.
6. When using Renesas Electronics products, refer to the latest product information (data sheets, user's manuals, application notes, "General Notes for Handling and Using Semiconductor Devices" in the reliability handbook, etc.), and ensure that usage conditions are within the ranges specified by Renesas Electronics with respect to maximum ratings, operating power supply voltage range, heat dissipation characteristics, installation, etc. Renesas Electronics disclaims any and all liability for any malfunctions, failure or accident arising out of the use of Renesas Electronics products outside of such specified ranges.
7. Although Renesas Electronics endeavors to improve the quality and reliability of Renesas Electronics products, semiconductor products have specific characteristics, such as the occurrence of failure at a certain rate and malfunctions under certain use conditions. Unless designated as a high reliability product or a product for harsh environments in a Renesas Electronics data sheet or other Renesas Electronics document, Renesas Electronics products are not subject to radiation resistance design. You are responsible for implementing safety measures to guard against the possibility of bodily injury, injury or damage caused by fire, and/or danger to the public in the event of a failure or malfunction of Renesas Electronics products, such as safety design for hardware and software, including but not limited to redundancy, fire control and malfunction prevention, appropriate treatment for aging degradation or any other appropriate measures. Because the evaluation of microcomputer software alone is very difficult and impractical, you are responsible for evaluating the safety of the final products or systems manufactured by you.
8. Please contact a Renesas Electronics sales office for details as to environmental matters such as the environmental compatibility of each Renesas Electronics product. You are responsible for carefully and sufficiently investigating applicable laws and regulations that regulate the inclusion or use of controlled substances, including without limitation, the EU RoHS Directive, and using Renesas Electronics products in compliance with all these applicable laws and regulations. Renesas Electronics disclaims any and all liability for damages or losses occurring as a result of your noncompliance with applicable laws and regulations.
9. Renesas Electronics products and technologies shall not be used for or incorporated into any products or systems whose manufacture, use, or sale is prohibited under any applicable domestic or foreign laws or regulations. You shall comply with any applicable export control laws and regulations promulgated and administered by the governments of any countries asserting jurisdiction over the parties or transactions.
10. It is the responsibility of the buyer or distributor of Renesas Electronics products, or any other party who distributes, disposes of, or otherwise sells or transfers the product to a third party, to notify such third party in advance of the contents and conditions set forth in this document.
11. This document shall not be reprinted, reproduced or duplicated in any form, in whole or in part, without prior written consent of Renesas Electronics.
12. Please contact a Renesas Electronics sales office if you have any questions regarding the information contained in this document or Renesas Electronics products.

(Note 1) "Renesas Electronics" as used in this document means Renesas Electronics Corporation and also includes its directly or indirectly controlled subsidiaries.

(Note 2) "Renesas Electronics product(s)" means any product developed or manufactured by or for Renesas Electronics.

## Table of Contents

Chapter 1	Introduction .....	6
1.1	Naming convention .....	7
1.2	Related documents .....	8
1.3	MF3 Data Flash.....	8
1.3.1	Dual operation.....	8
1.4	Functional elements within the EEPROM Emulation system .....	9
1.5	Pool structure .....	10
1.6	Address virtualization .....	11
Chapter 2	EEL architecture .....	12
2.1	EEL pool structure.....	12
2.2	EEL block structure .....	14
2.2.1	EEL block header .....	15
2.2.2	Reference area .....	16
2.2.3	Data area .....	16
2.3	EEL Instance structure.....	17
2.3.1	Data Reference Pointer, DRP.....	17
2.3.2	Instance data .....	17
2.3.3	Data Checksum, DCS.....	18
2.4	Block management .....	18
2.4.1	EEL block circulation .....	18
2.4.2	EEL block status .....	19
2.4.3	Security aspects, block exclusion .....	19
2.5	Instance management .....	20
2.5.1	Write instance sequence .....	21
2.5.2	Security aspects, checksums .....	21
2.6	Processes .....	22
2.7	Space treatment.....	23
2.8	Request–Response oriented dialog.....	24
2.9	Handler oriented command execution .....	25
2.10	Execution modes of the EEL.....	26
2.10.1	Enforced execution mode .....	27
2.10.2	Timeout execution mode .....	30
2.10.3	Polling execution mode.....	33
2.11	Supported command spectrum.....	36
2.12	EEL execution planes .....	37
2.12.1	Foreground plane .....	37
2.12.2	Background plane.....	38
Chapter 3	Application Programming Interface.....	39

3.1	Data types .....	39
3.1.1	Library specific simple type definitions .....	39
3.1.2	Enumeration type "eel_command_t" .....	39
3.1.3	Enumeration type "eel_operation_status_t" .....	40
3.1.4	Enumeration type "eel_access_status_t" .....	40
3.1.5	Enumeration type "eel_status_t" .....	41
3.1.6	Structured type "eel_request_t" .....	42
3.1.7	Structured type "eel_driver_status_t" .....	42
3.2	Functions.....	43
3.2.1	EEL_Init .....	43
3.2.2	EEL_Open .....	44
3.2.3	EEL_Close .....	45
3.2.4	EEL_Execute .....	46
3.2.5	EEL_Handler.....	48
3.2.6	EEL_TimeOut_CountDown .....	50
3.2.7	EEL_GetDriverStatus .....	51
3.2.8	EEL_GetSpace .....	54
3.2.9	EEL_GetVersionString.....	56
Chapter 4	Operation .....	58
4.1	Obtaining the Library.....	58
4.2	Installation .....	58
4.2.1	File Structure.....	58
4.3	Basic workflow .....	60
4.4	Configuration.....	61
4.4.1	Pool configuration .....	61
4.4.2	Endurance Calculation.....	62
4.4.3	Variable configuration .....	62
4.4.4	EEL Variable Initialization .....	63
4.4.5	Pool configuration hints and tips.....	64
4.5	Initialization .....	68
4.6	EEL activation and deactivation.....	68
4.7	Foreground and background process .....	69
4.7.1	Controlling background process .....	69
4.8	Commands.....	72
4.8.1	Pool oriented commands .....	72
4.8.2	Variable oriented commands .....	85
Chapter 5	Characteristics .....	96
5.1	Resource consumption .....	96
5.2	Timing characteristics .....	96

5.2.1 Reference command execution times ..... 96  
Chapter 6 Cautions.....99  
Revision History.....101

## Chapter 1 Introduction

This user's manual describes the internal structure, the functionality and the software interface (API) of Renesas RL78 EEPROM Emulation Library (EEL) Type 01, designed for RL78 flash devices with so called Data Flash based on the MF3 flash technology.

The EEL Type 01 provides APIs for the C and assembly language of the CA78K0R, IAR V1.xx and IAR V2.xx tool chains. (APIs for the assembly language are provided by the CA78K0R tool chain only.)

The EEL Type 01 for IAR V2.xx tool chain (except linker sample file) can also be used with the IAR V3.xx and IAR V4.xx tool chains.

The EEL is the highest layer of Renesas EEPROM Emulation System which aspires to mime at least the functionality of a non-volatile memory (internal EEPROM) under usage of the on-chip embedded flash memory. Beyond that drivers service and administrative functionality is provided by the EEL to simplify the handling at application side.

Figure 1-1 Elements of the EEPROM Emulation System

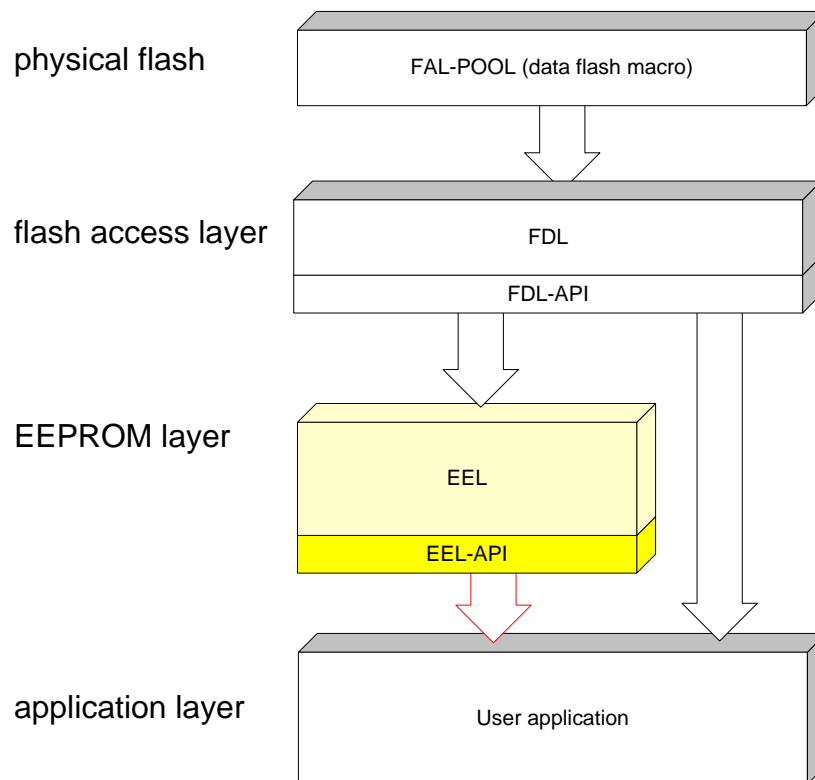

**Note:**

This user's manual describes the functional block marked in yellow

## 1.1 Naming convention

Certain terms, required for the description of the Flash and EEPROM emulation are long and too complicated for good readability of the document. Therefore, special names and abbreviations will be used in the course of this document to improve the readability.

Table 1-1 Used abbreviations and acronyms

Abbreviations / Acronyms	Description
Block	Smallest erasable unit of a flash macro
Code Flash	Embedded Flash where the application code is stored. For devices without Data Flash EEPROM emulation might be implemented on that flash in the so called data area.
Data Flash	Embedded Flash where mainly the data of the EEPROM emulation are stored. Beside that also code operation might be possible.
Dual Operation	Dual operation is the capability to fetch code during reprogramming of the flash memory. Current limitation is that dual operation is only available between different flash macros. Within the same flash macro it is not possible!
EEL	EEPROM Emulation Library
EEPROM emulation	In distinction to a real EEPROM the EEPROM emulation uses some portion of the flash memory to emulate the EEPROM behavior. To gain a similar behavior some side parameters have to be taken in account.
FAL	Flash Access Library (Flash access layer)
FCL	Code Flash Library (Code Flash access layer)
FDL	Data Flash Library (Data Flash access layer)
Flash	"Flash EPROM" - Electrically erasable and programmable nonvolatile memory. The difference to ROM is, that this type of memory can be re-programmed several times.
Flash Block	A flash block is the smallest erasable unit of the flash memory.
Flash Macro	A flash comprises of the cell array, the sense amplifier and the charge pump (CP). For address decoding and access some additional logic is needed.
NVM	Non volatile memory. All memories that hold the value, even when the power is cut off. E.g. Flash memory, EEPROM, MRAM...
RAM	"Random access memory" - volatile memory with random access
ROM	"Read only memory" - nonvolatile memory. The content of that memory can not be changed.
Serial programming	The onboard programming mode is used to program the device with an external programmer tool.
Single Voltage	For the reprogramming of single voltage flashes the voltage needed for erasing and programming are generated onboard of the microcontroller. No external voltage needed like for dual- voltage flash types.

## 1.2 Related documents

Table 1-2 List of related documents

Document Number	Description
R01US0034EDxxxx	Data Flash Access Library Type T01

## 1.3 MF3 Data Flash

Almost all devices of the RL78 microcontroller family are equipped with a separate flash area called Data Flash.

### 1.3.1 Dual operation

Common for all Flash implementations is, that during Flash modification operations (Erase/Write) a certain amount of Flash memory is not accessible for any read operation (e.g. program execution or data read).

This does not only concern the modified Flash range, but a certain part of the complete Flash system. The amount of not accessible Flash depends on the device architecture.

A standard architectural approach is the separation of the Flash into Code Flash and Data Flash. By that, it is possible to fetch instruction code from the Code Flash (to execute program) while data are read or written into Data Flash. This allows implementation of EEPROM emulation concepts running quasi parallel to the application software without significant on its execution timing.

If not mentioned otherwise in the device user's manuals, RL78 device with Data Flash are designed according to this standard approach.

**Note:**

**It is not possible to modify Code Flash and Data Flash in parallel.**



## 1.4 Functional elements within the EEPROM Emulation system

Even though this user's manual describes the functional block "EEPROM Emulation Library" a short description of all concerned functional blocks and their relationship could be beneficial for the general understanding of the system. The following figure illustrates the basic idea behind and its involved functional blocks but the shown dependencies are not complete.

Figure 1-2 Relationship between functional blocks inside the EEPROM emulation systems

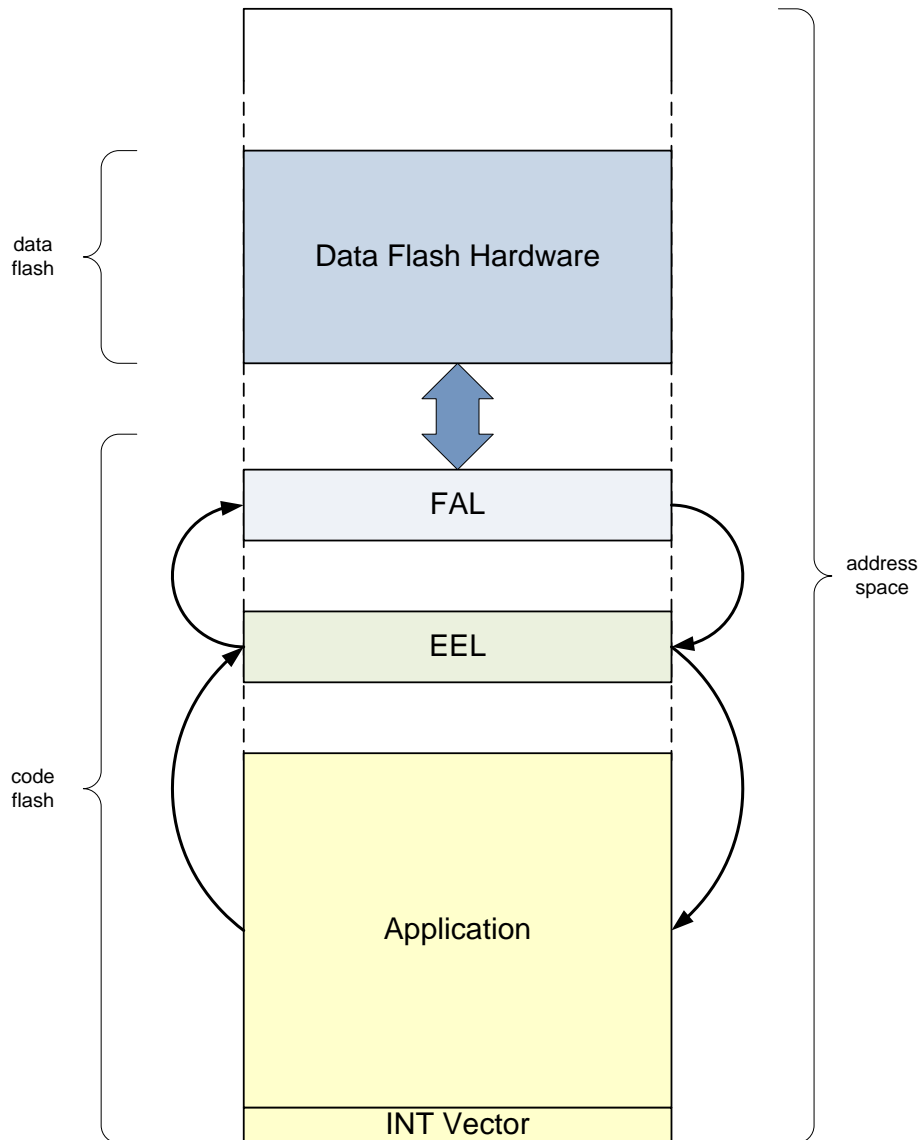

### Application:

The functional block "Application" contains the instruction code of user's software using the EEL.

**EEPROM Emulation Library (EEL):**

The functional block “EEPROM Emulation library” is the subject of this user’s manual. It offers all functions and commands the “Application” can use in order to handle its EEPROM data.

**Data Flash Access Library (FAL):**

The “Data Flash Access Library” offers an interface to access any user-defined flash area, so called “FDL-pool” (described in next chapter). Beside the initialization function the FDL allows the execution of access-commands like write as well as a suspend-able erase command.

**Note:**

General requirement is to be able to deliver pre-compiled EEL libraries, which can be linked to either Data Flash Access Libraries (FDL) or Code Flash Access Libraries (FCL). To support this, a unique API towards the EEL must be provided by these libraries. Following that, the standard API prefix FDL\_... which would usually be provided by the FDL library, will be replaced by a standard Flash Access Layer prefix FAL\_... All functions, type definitions, enumerations etc. will be prefixed by FAL\_ or fal\_. Independent from the API, the module names will be prefixed with FDL\_ in order to distinguish the source/object modules for Code and Data Flash.

## 1.5 Pool structure

The EEL-pool is a part of the FDL-pool defined by the user in the file `fdl_descriptor.h`. In that file the user can divide the FDL-pool into two independent parts: the EEL-pool (used exclusively by the EEL only) and the USER-pool which can be freely used by the application to store any data.

To protect the content of the EEL-pool against unwanted user accesses the EEL-driver is using only hidden subroutines reserved exclusively for the EEL.

**Pool details:**

- **FDL-pool** allocates the physical Data Flash memory that can be handled by the FDL. It is a kind of container reserving room for the EEL-pool and USER-pool. All characteristics (valid address information, partitioning information, ...) of the FDL-pool are defined in the FDL-pool descriptor. Based on that information the FDL protect all flash content against illegal access.
- **EEL-pool** is a virtual pool inside the FDL-pool used exclusively by the EEL for storing data and control information.
- **User Pool** is completely in the hands of the user application. It can be used to build up an own user EEPROM emulation or to simply store constants.

**Note:**

Please refer to the FDL user’s manual for further details.

Figure 1-3 Pool access scheme, general scheme

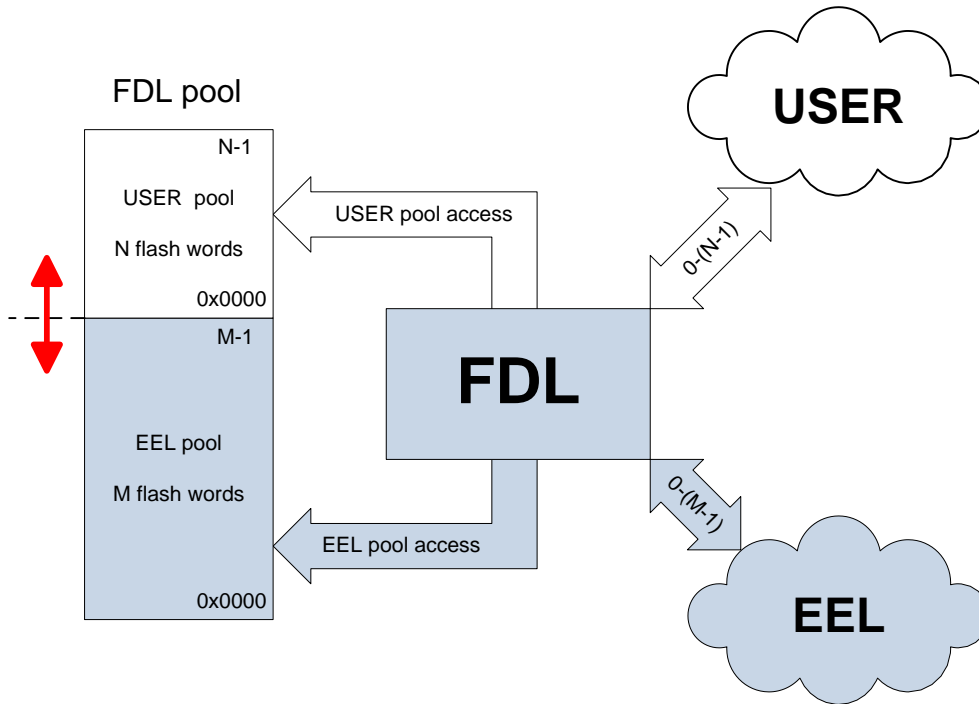

## 1.6 Address virtualization

To simplify the flash content handling as well the parameter passing between the FAL and the EEL the physical addresses used by the flash hardware were transformed into a linear 16-bit index addressing flash-words (32-bit units) inside the corresponding pool. By this measure each owner of the pool can use it as a simple array of words. To address the array elements (read/write access) word-index starting at 0x0000 can be used. The max. range of the word-index depends on the FAL-pool configuration and the number of flash blocks reserved for the particularly pool. This kind of address virtualization allows to access max 2 \* 256kBytes Data Flash and offers an effective access rights management.

Note:

The user of the EEL is not touched by the above address virtualization.

## Chapter 2 EEL architecture

This chapter describes the internal architecture of the EEPROM Emulation Library.

### 2.1 EEL pool structure

The EEL pool is the virtual storage medium used by the EEL driver for storing data and block management information during its operation. From logical point of view the EEL-pool is organized as a single-linked ring of blocks.

“Single-linked ring” means here:

- the next block to block N is block (N+1)
- the next block to the last one is the first one.

Figure 2-1 Structure of an empty EEL pool (no data inside)

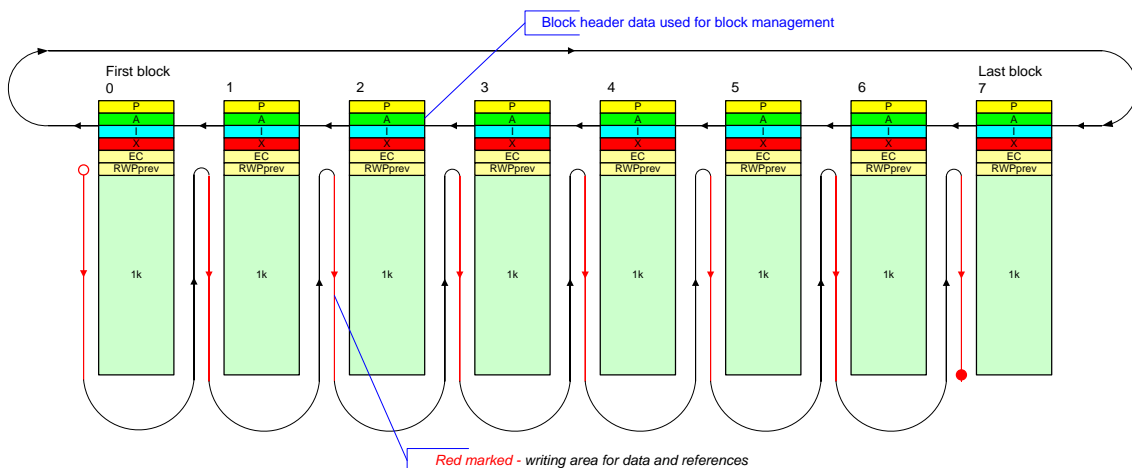

Each block of the EEL-pool contains a block-header for storing block management information. Because the block indexing within the EEL-pool is based on the homogenous and fixed virtual block numbers 0x0000.... (EEL\_POOL\_SIZE - 1) it is not necessary to store the neighbors inside the block header.

All flash-blocks of the EEL pool are grouped in three consecutive “regions” indicated by the “block status” in the block header.

- |                   |   |
|-------------------|---|
| “active region”   | - consists of blocks containing active data         |
| “invalid region”  | - consists of blocks without active data            |
| “prepared region” | - consists only of blocks ready to receive new data |

When contemplate EEL-pool blocks clockwise the regions are always in the same fixed chronological order:

- “prepared region” is before “active region”
- “active region” is before “invalid region”
- “invalid region” is before “prepared region”

Figure 2-2 EEL pool regions during normal operation

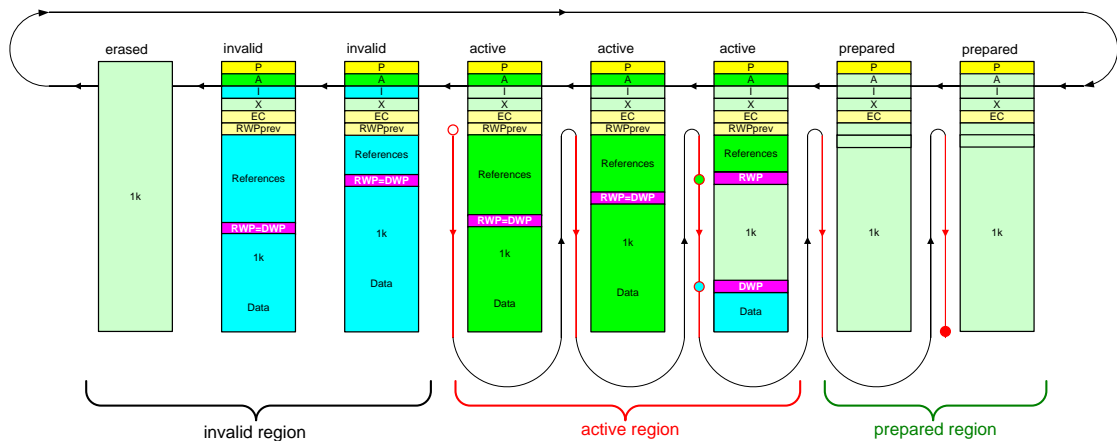

Block organization scheme based illustrated above offers following advantages:

- a) two symmetrical sections (where always 50% of Data Flash does not contain valid data) are not needed anymore
- b) the “active region” can grow and be adapted to the momentary need
- c) the reference area is separated from the data inside the same EEL block
- d) copy-processes are mostly much faster because reduced to the only last active block has to be released from valid instances.
- e) exclude functionality does not reduce performance of the driver

## 2.2 EEL block structure

Each EEL block belonging to the EEL-pool is basically divided into three areas: the block header, reference area and the data area. The block-header contains information about the actual status of the block which is needed for the block-management within the pool. The reference area contains reference entities off all instances written into this block during its live-cycle. It is necessary for actual data localization after power-on. The data area contains the pure data belonging to the corresponding references in reference area.

Figure 2-3 EEL block, general structure

wid <sub>x</sub>	byte 0	byte 1	byte 2	byte 3	bid <sub>x</sub>
0	P				0
1	A				4
2	I				8
3	X				12
4	CS (EC)	EC			16
5	RWPprev		OOH	CS8	20
6	CS (XEC)	XEC			24
7	FIP flag				28
8	wid <sub>x</sub>	CS8		ID_1	32
9	CS32 (data)				36
10	wid <sub>x</sub>	CS8		ID_2	40
11	CS32 (data)				44
12	wid <sub>x</sub>	CS8		ID_3	48
13	CS32 (data)				52
14	wid <sub>x</sub>	CS8		ID_4	56
15	CS32 (data)				60
16	wid <sub>x</sub>	CS8		ID_5	64
17	CS32 (data)				68
18	wid <sub>x</sub>	CS8		ID_6	72
19	CS32 (data)				76
20	wid <sub>x</sub>	CS8		ID_7	80
21	CS32 (data)				84
22	wid <sub>x</sub>	CS8		ID_8	88
23	CS32 (data)				92
24	wid <sub>x</sub>	CS8		ID_9	96
25	CS32 (data)				100
26	wid <sub>x</sub>	CS8		ID_10	104
27	CS32 (data)				108
28	0xff	0xff	0xff	0xff	112
29	0xff	0xff	0xff	0xff	116
30	0xff	0xff	0xff	0xff	120
31	0xff	0xff	0xff	0xff	124
...					...
...					...
...					...
232	0xff	0xff	0xff	0xff	943
233	0xff	0xff	0xff	0xff	947
234	0xff	0xff	0xff	0xff	951
235	data	data	0xff	0xff	955
236	data	data	data	data	959
237	data	data	data	data	963
238	data	0xff	0xff	0xff	967
239	data	data	data	data	971
240	data	data	data	data	975
241	data	data	data	data	979
242	data	data	data	data	983
243	data	data	data	0xff	987
244	data	data	data	data	991
245	data	data	0xff	0xff	995
246	data	data	data	data	999
247	data	0xff	0xff	0xff	1003
248	data	data	data	data	1007
249	data	data	data	data	1011
250	data	data	data	0xff	1015
251	data	data	0xff	0xff	1019
252	data	0xff	0xff	0xff	1023
wid <sub>x</sub>					bid <sub>x</sub>

## 2.2.1 EEL block header

The block header is a small area on the top of each flash block belonging to the EEL pool. It contains all information necessary for block management during EEL operation. The structure of the block header is the same in all blocks of the EEL-pool.

Figure 2-4 EEL block header structure

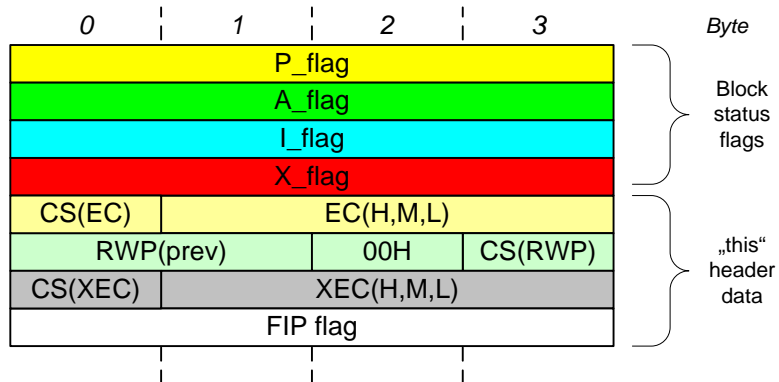

### 2.2.1.1 EEL block status flags

Each flag within the block header consists of one flash word (4 bytes).

There are two types of block status flags:

- “constructive status flag” used in processes like “activation” and “preparation”
- “destructive status flags” used in processes like “invalidation” and “exclusion”

When reading the exact pattern 0x55555555 a “constructive” flag is TRUE

When reading a pattern other than 0xFFFFFFFF a “destructive” flag is TRUE

When setting “constructive” flag: 0x55555555 is written into the flag-word.

When setting “destructive” flag: 0x00000000 is written into the flag-word.

**P\_flag:** = 0x55555555 marks a “prepared” block that waits for data.

**A\_flag:** = 0x55555555 marks an “active” block that may contain data

**I\_flag:** ≠ 0xFFFFFFFF marks an “invalid” block (without valid data)

**X\_flag:** ≠ 0xFFFFFFFF marks a block “excluded” from block management.

#### 2.2.1.2 EEL block erase counter

The block header word four contains the block erase counter. Its consistency is protected by an 8 bit checksum which is used by the EEL internally only.

#### 2.2.1.3 EEL previous reference write pointer

Its points the last RWP position of the previous block within the EEL pool. It is used by the EEL internally only.

#### 2.2.1.4 EEL exclusion erase counter

Stores the EC value at exclusion time. It is used by the EEL internally only.

#### 2.2.1.5 EEL Format In Progress (FIP) indicator

FIP<>0xFFFFFFFF indicates an FORMAT command discontinued by RESET. It marks the completely EEL pool as inconsistent and enforces the user to re-start the FORMAT command.

### 2.2.2 Reference area

The “reference area” is located in each EEL block directly behind the block header. It consists of so called reference entries that are used for instance identification, localization and for safeguarding during the read/write process. When writing new data into the EEL a corresponding reference entry is stacked in the reference area.

The reference area is growing upstairs from lower widx to higher.

### 2.2.3 Data area

The “data area” consists of data-records and is located on the bottom of each EEL pool block. Each data record within the data area consists of pure data information without any data- frame. The data-frame information exists completely in the corresponding reference-entry in the reference-area.

When writing new data into the EEL the data area is growing downstairs from higher widx to lower.



## 2.3 EEL Instance structure

EEL instance is a complete data-set consisting of three components:

- 32-bit data reference pointer DRP in the reference area
- the data in the data area
- 32-bit checksum in reference area (directly behind the corresponding DRP)

Whenever the application writes a new value into the EEL pool a new EEL instance is generated.

### 2.3.1 Data Reference Pointer, DRP

The main purpose of the DRP is referencing the data belonging to the given instance inside the data-area. The consistency of the DRP is safeguarded by an own 8-bit checksum. A DRP is always written to an even flash word index inside the reference area.

The structure of each DRP consists of:

- ID: 8-bit EEL-variable identifier registered in the EEL descriptor.
- widx: 16-bit virtual index inside EEL pool pointing to the data
- RCS: Reference Check Sum, 8-bit checksum across the DRP.

Figure 2-5 Structure of the DRP

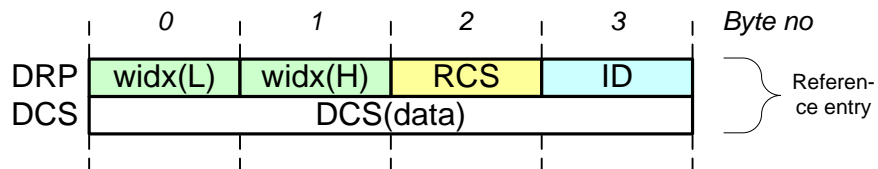

### 2.3.2 Instance data

The pure instance data without any frame-information stored directly in the data area at the bottom of the corresponding block.

Figure 2-6 Example of 6-byte data entry

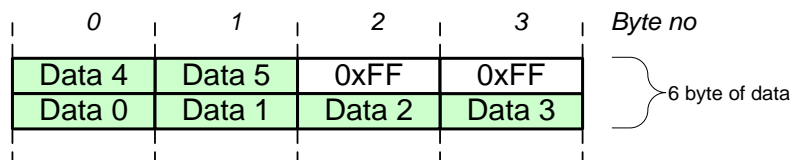

Note:

Not used bytes remain 0xFF.

### 2.3.3 Data Checksum, DCS

The DCS is written behind the DRP in the reference area behind the corresponding DRP after the instance data were written correctly. It ensures the plausibility of the data and the corresponding DRP.

Figure 2-7 Data Checksum of an instance

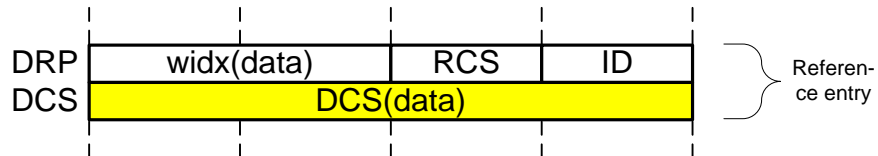

## 2.4 Block management

This chapter describes how the block management organizes the blocks inside the EEL pool during its operation.

### 2.4.1 EEL block circulation

The block management is leaned on the concept of single linked ring. It is build based on the unique virtual block numbers inside the EEL pool. It is an easy scheme for "creation" and "consumption" of writeable space inside the EEL-pool. As already mentioned the whole EEL pool is divided into three regions organized in a fixed order.

Active region:	always in front of the invalid region
Prepared region:	always in front of the active region
Invalid region :	always in front of the prepared region

From the operation point of view the block management works like a caterpillar. The following figure should illustrate the idea behind the block management:

Figure 2-8 Circulatory block management inside the EEL pool

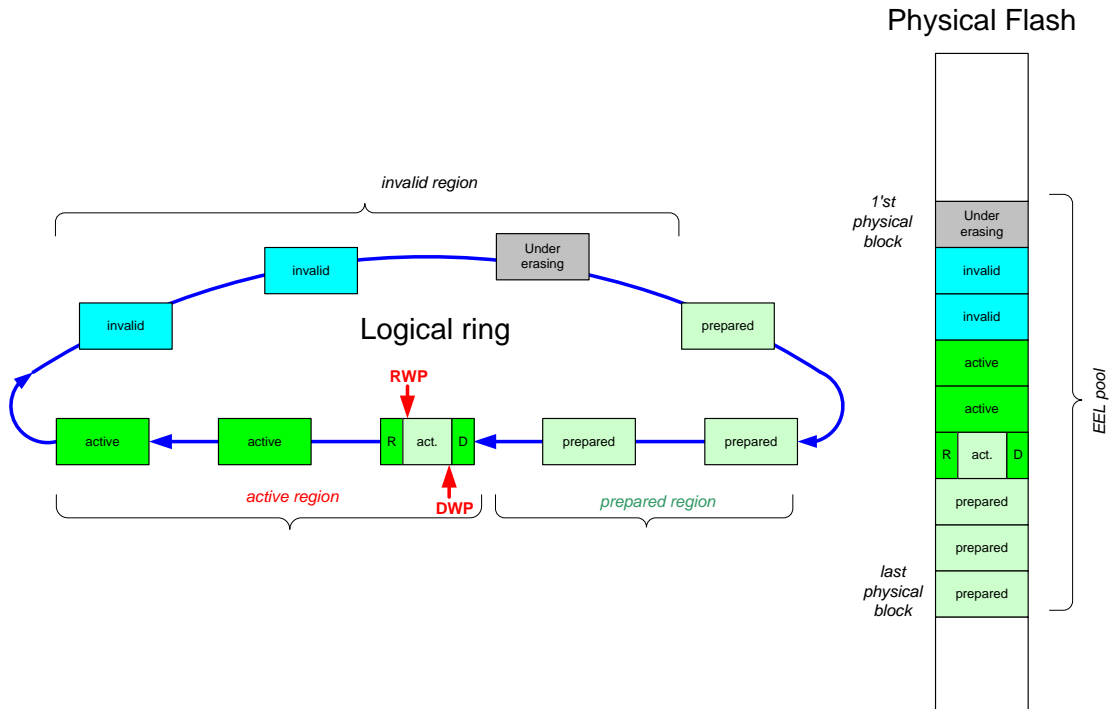

### 2.4.2 EEL block status

During the operation of the EEPROM driver the participating flash blocks change their internal status cyclically. To mark and to recognize the status of each block 32-bit block-status flags are used. The block status-flags are read and analyzed after power-on RESET to reconstruct the current EEL pool configuration. The block management based on that information is fundamental for correct operation of the EEL driver.

### 2.4.3 Security aspects, block exclusion

When erasing a flash block in the "preparation" process an erase-error could happen theoretically. The probability is very low but if happens, it is not allowed to write data into such a block. To fulfill this condition the "exclusion" mechanism was added to the block management

Basically during block preparation write-error can be generated when writing block header information. In that case the effected block will be excluded from block management too.

An asynchronous device RESET during operation of the EEL may cause various problems like inconsistent pool or inconsistent data. The STARTUP command detects such problems and performs fitting countermeasure to recover pool and data consistency

As already mentioned, there are two different types of block status flags:

- 1) Constructive block status flags are the P-Flag and the A-Flag.  
 Coding: writing pattern 0x55555555 into the flag flash-word.  
 Decoding: TRUE when read pattern is 0x55555555 otherwise FALSE.
- 2) Destructive block status flags are the I-Flag and the X-Flag.  
 Coding: writing pattern 0x00000000 into the flag flash-word.  
 Decoding: FALSE when pattern inside is 0xFFFFFFFF otherwise TRUE.

Analyzing the block header flags the EEL is in the position to recognize the status of each block of the EEL pool. Following scenarios are possible:

Figure 2-9 Block status code

	still	erased =	prepared		active		invalid		excluded	
	invalid	invalid	ongoing	ready	ongoing	ready	ongoing	ready	ongoing	ready
P-flag	????????	FFFFFFF	????????	55555555	55555555	55555555	55555555	55555555	XXXXXXXX	XXXXXXXX
A-flag	????????	FFFFFFF	FFFFFFF	FFFFFFF	????????	55555555	55555555	55555555	XXXXXXXX	XXXXXXXX
I-flag	????????	FFFFFFF	FFFFFFF	FFFFFFF	FFFFFFF	FFFFFFF	????????	00000000	XXXXXXXX	XXXXXXXX
X-flag	????????	FFFFFFF	FFFFFFF	FFFFFFF	FFFFFFF	FFFFFFF	FFFFFFF	FFFFFFF	????????	00000000

Block status:	← invalid →	← prepared →	← invalid →	← active →	← invalid →	← excluded →
---------------	-------------	--------------	-------------	------------	-------------	--------------

Note:  
 Invalid block status can be produced by RESET during block activation (red marked here) is repaired in the STARTUP command sequence.

## 2.5 Instance management

Whenever a new instance of an EEL variable is written into the EEL-pool, the following sequence is executed by the EEL-driver internally:

### Step 1)

Data-Reference-Pointer (DRP) is calculated and written into the flash word referenced by RWP. After that the space for instance data is allocated in the data area of the active region.

### Step 2)

Write the complete instance data word by word into the reserved in step 1)

### Step 3)

Calculate and write the checksum DCS into the word next to DRP from step 1)

### 2.5.1 Write instance sequence

Whenever a new instance of an EEL variable is written into the EEPROM the following sequence is executed by the EEL-driver:

Writing a new instance of an EEPROM variable consists of three successive phases.

Figure 2-10 Write instance sequence

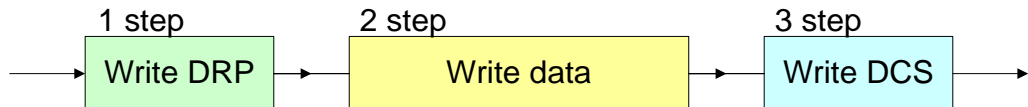

The structure and the handling of the instance references should manage possible destructive effects caused by asynchronous power-on RESET as well as by potential flash problems.

### 2.5.2 Security aspects, checksums

When writing a new value of EEPROM variable into EEL the reference and the data are written flash-word wise into the EEL-pool. During this process an asynchronous RESET may happen at any time and produce rubbish data. To ensure a reliable detection of any data inconsistency within a written instance two stage checksum protection has been implemented. The first checksum (8 bit) ensures the consistency of the DRP written in phase 1). This checksum is a part of the 32-bit DRP. The second checksum is calculated and written in phase 3. It is a 32-bit checksum calculated across all data written in phase 1) and 2) (over DRP and all data words).

The consistency of the instance is checked in the STARTUP and in the READ command.

- when STARTUP command detects checksum error during instance searching (RAM reference fill process) the corresponding instance will be ignored.

- when READ command detects a checksum error the instance search will be restarted (same criteria as for STARTUP), the RAM reference table refilled and the newest instance with correct checksum will be read finally.

## 2.6 Processes

All things happening in the EEL (data access, CPU processing, administrative activities....) take time. Sequences of actions, measures and countermeasures to achieve any targeted effect/result are called processes here.

There are two groups of EEL processes:

### Foreground process:

Initiated by the user, when requesting commands at the EEL.

### Background process:

Initiated by the EEL themselves, when it recognizes the necessity internally.

In exceptional cases foreground processes can initiate background processes.

From block management point of view each block is sorted into one of the three regions within the EEL pool (active, prepared, invalid) or it can be excluded. A block can change from one region to another one when being treated by dedicated "processes".

Also the instance management influences the position of the instances within the EEL pool using background and/or foreground processes.

Figure 2-11 Overview of the main processes inside the EEL driver

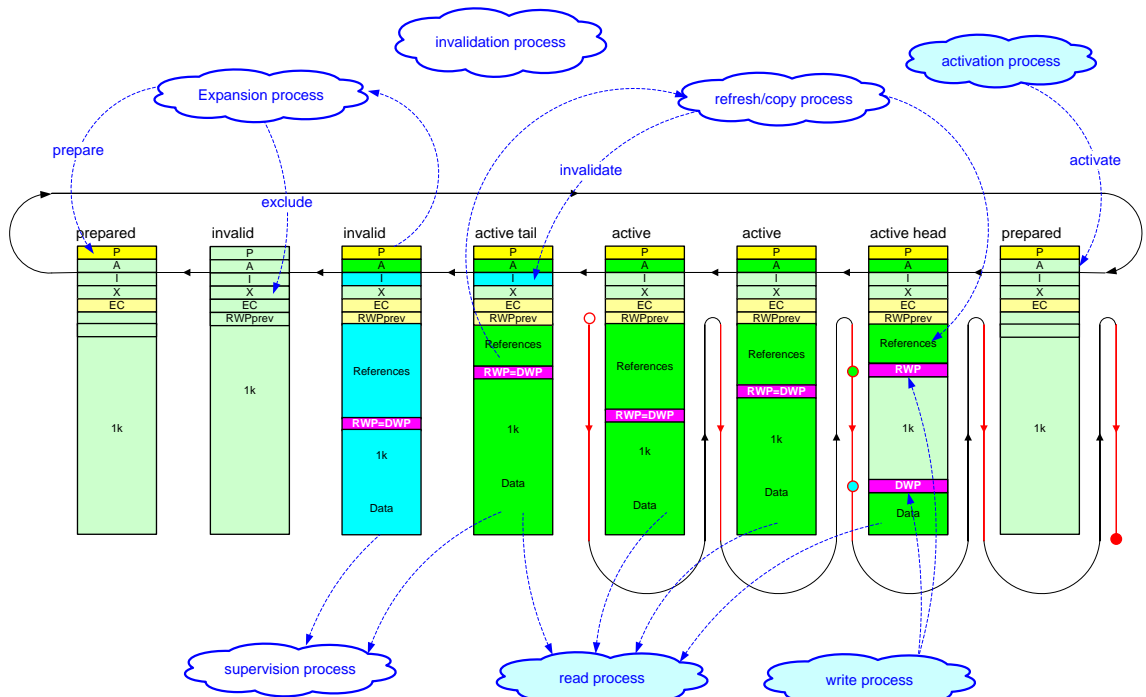

## 2.7 Space treatment

Space within the EEL pool is the sum of all flash words prepared for the accommodation of data and references (exclusive block header area).

Internally the EEL driver differentiates between pool-space and active-space.

Pool-space is the space available in all prepared blocks plus the remaining space available in the active heading block.

Active-space is the space available in active heading block only.

Both can be effected by background and foreground processes as follows:

Pool-space is produced in the background PREPARATION process only.

Pool-space is consumed by foreground WRITE command or background REFRESH process.

Active-space is consumed by foreground WRITE command or background REFRESH process.

Active-space is enlarged by foreground or background ACTIVATION process.

The user does not need to take care for the space management during EEL operation. Depending on the configuration and used operation mode the EEL takes care internally for adequate space conditions.

## 2.8 Request–Response oriented dialog

Like the FAL, the EEL is also using the Request-Response architecture to place and process the commands. This means the “requester” (normally users Application) has to fill-up a kind of “request form sheet” (the request variable) and pass it to the EEL using the reference (pointer) of the request variable for further processing. The EEL is interpreting the request variable, check its plausibility and process it for the time slice defined in the request variable. After time-out period or after finishing the execution with positive/negative command execution the EEL is updating the status code in the request variable.

The biggest advantage of the request-response architecture is the constant and narrow parameter interface. It allows constant parameter passing independent used compiler and its memory models.

Another advantage is the possibility to isolate the dialog in multi-tasking systems.

Figure 2-12 Schematic usage of the request variable

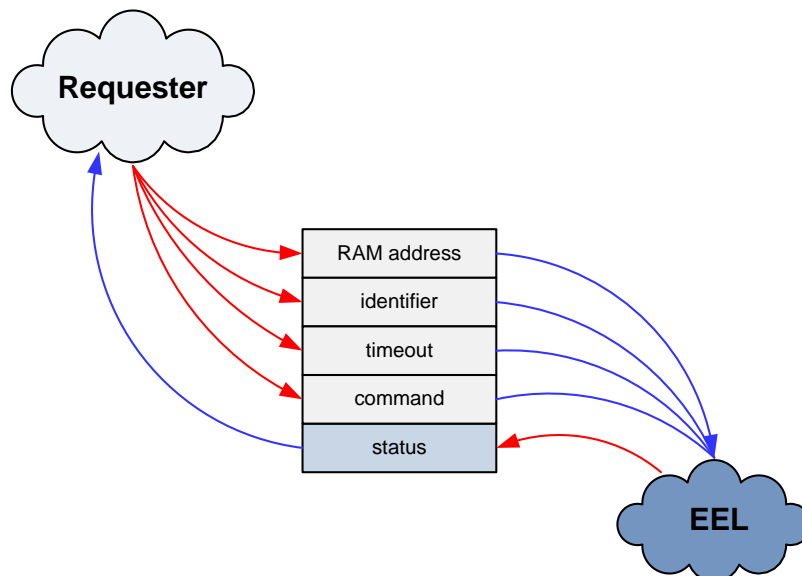



## 2.9 Handler oriented command execution

To satisfy operation in concurrent or distributed systems the command execution is divided generally into two phases:

- 1) Initiation of command execution using `EEL_Execute(&my_eel_request)`
- 2) processing of the command that is performed piece-wise (state-wise or time-slice-wise depending on the used execution mode)

The main advantage of such architecture is that maintenance and command processing can be done centrally on one place in the target system (normally the idle-loop or the scheduler loop).

The other advantage is that commands can be requested in several places in the system. Using separate request variables the EEL feedback can be directed correctly in spite of the fact, that the processing is done centrally.

The EEL is using the function `EEL_Execute(&my_eel_request)` for command initiation and `EEL_Handler(my_eel_timeslice)` for command processing.

## 2.10 Execution modes of the EEL

One claim of this EEPROM driver is to satisfy all the various systems and SW architectures exit in the market. Some target systems does not care about execution time and use EEL-commands like function call. Some other systems use complex operating systems to manage task execution quasi simultaneously (time sharing). Another use even driven asynchronous mechanisms only.

To fulfill the above requirements, the EEL offers several operation modes that can deal with the parameter "time" in different way.

There are two places where the "time" parameter can be treated :

a) in the request-variable passed by the `EEL_Execute(&my_eel_request)`

This timeout value determines the operation mode of the EEL command.

`my_eel_request.timeout_u08 = 0x00` -> execution in polling mode  
`0x00 < my_eel_request.timeout_u08 < 0xFF` -> execution in timeout mode  
`my_eel_request.timeout_u08 = 0xFF` -> execution in enforced mode

b) by the timeout parameter of the `EEL_Handler(my_eel_timeslice_u08)`

`my_eel_timeslice_u08 = 0x00` -> execute the actual EEL state only  
`my_eel_timeslice_u08 > 0x00` -> execute the time-slice EEL

Table 2-1 Overview of time parameter meaning

Timeout	Execution mode	EEL behaviour
0x00	polling	<b>EEL_Execute(t):</b> starts the command and leaves EEL immediately <b>EEL_Handler(t):</b> executes next internal state of the EEL
0x00<N<0xFF	timeout	<b>EEL_Execute(t):</b> executes states until timeout or command is finished <b>EEL_Handler(t):</b> executes states until timeout or command is finished
0xFF	enforcing	<b>EEL_Execute(t):</b> executes command until it's finished <b>EEL_Handler(t):</b> executes states until command or timeout is finished

Depending on the target system architecture one of the operation modes can be used for command execution and background maintenance purpose.

Note:

The timeout used in the request variable is completely independent on the timeout used in the `EEL_Handler(t)` mixing of the operation modes in one target system is possible.

Figure 2-13 Overview over the EEL operation modes

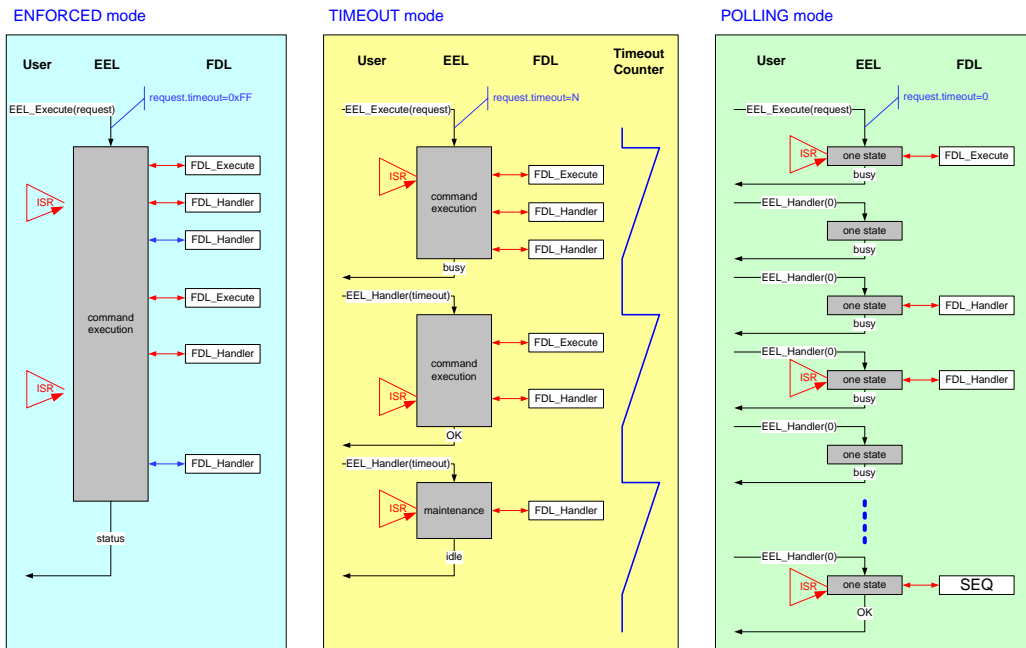

**2.10.1 Enforced execution mode**

This mode can be used in simple systems in that EEPROM access have to be processed like a simple function CALL. The requested command is directly and completely executed with positive or negative result. The handling is very easy, the background process that takes care for maintenance is not visible to the user.

Command execution in enforced mode is determined by timeout =0xFF in the request variable. When using enforced mode for command execution, the target system can use the EEL\_Handler(t) for background maintenance (space generation) but it is not mandatory.

Figure 2-14 Schematic illustration of the enforced operation mode

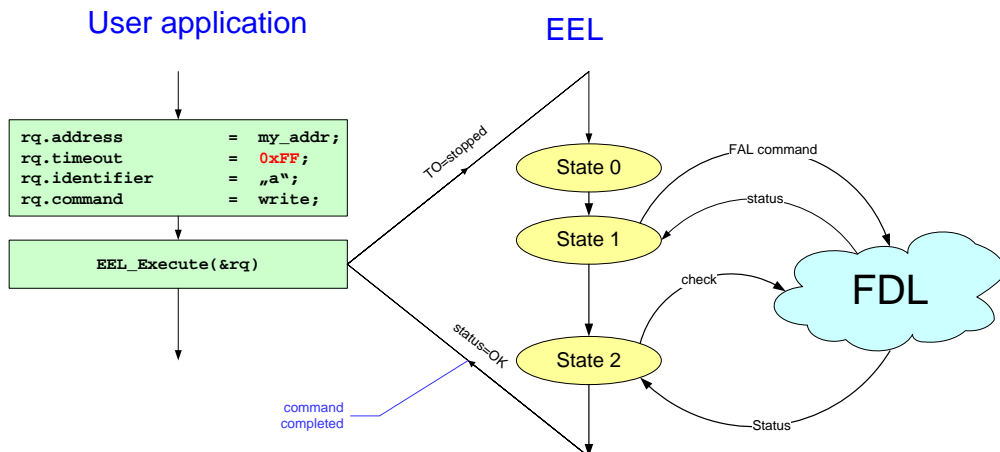

### 2.10.1.1 Enforced operation mode without usage of EEL\_Handler(t)

The available space (inside the active and prepared regions) for accommodation of variable instances is limited. When executing commands in enforced mode without EEL\_Handler(t) the available space decreases continuously during writing as long as the space becomes consumed. In that case new space must be generated internally inside the EEL before starting the command execution. This means that the execution time of “space consuming” commands (the WRITE command) cannot be constant. On the other hand the user does not need to take care for background maintenance.

When pure enforced mode is used in the target system the EEL\_TimeOut\_CountDown() function as well the EEL\_Handler(t) are mandatory.

Figure 2-15 Timing example of enforced command execution without EEL\_Handler(t)

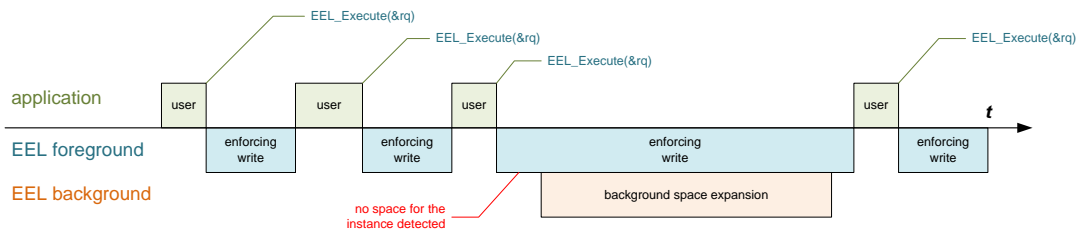

Example conditions:

rq.address_pu08	- no meaning for the timing
rq.identifier_u08	- always same identifier used
rq.timeout_u08	- always 0xFF used
rq.command_enu	- always EEL_CMD_WRITE command used

### 2.10.1.2 Enforced mode with background maintenance

To enjoy the simplicity of the enforced execution mode without the disadvantage of not pre-determinable execution time the application can use EEL\_Handler(t) to prepare space in advance in convenient phases.

Calling EEL\_Handler(t) cyclically at idle time (no EEL command under execution) the application activates the EEL background supervision and maintenance process. The background supervision checks if the momentary EEL-pool status does still correspond with the EEL-pool configuration. If not enough space detected by the background supervision, the background maintenance starts space production process autonomous. This is the instrument the application can use to produce enough space in advance and to guaranty fast and constant write execution time at any time.

Note:

The foreground writing and background maintenance are dynamical processes that influence each other. To ensure constant execution time of the WRITE command the application must provide enough CPU time to the background process. The relationship between “production of space” in the background and “consumption of space” by foreground writing must match.

The degree of “space production” is only determined by the CPU time offered to the background process via EEL\_Handler(t).

The degree of “space consumption” is determined by the frequency and size of variables written into the EEL-pool, as well by the space needed for refreshing variables in background maintenance.

Figure 2-16 Timing example of enforced command execution using EEL\_Handler(t)

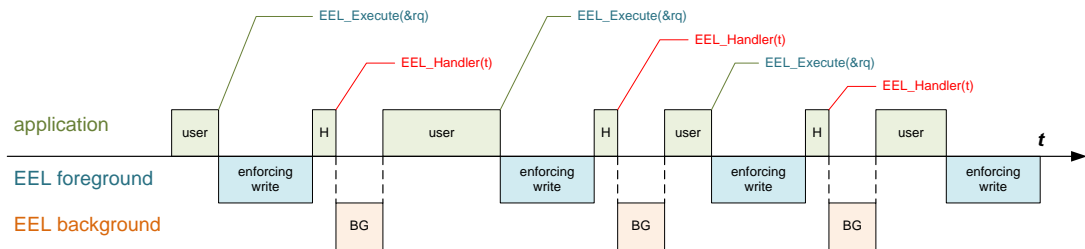

Example conditions:

- |                   |  |
|-------------------|--|
| rq.address_pu08   | - no meaning for the timing                        |
| rq.identifier_u08 | - always same identifier used                      |
| rq.timeout_u08    | - always 0xFF used                                 |
| rq.command_enu    | - always EEL_CMD_WRITE command used                |
| time              | - used by EEL_Handler(t) for time-slice definition |

### 2.10.2 Timeout execution mode

In the timeout execution mode the requester can determine the CPU time for the command execution in advance. The resolution of the time period is defined freely by the user when choosing the counting interrupt source. The timeout period is defined in counting ticks. If the timeout period is longer than the real command execution time, the command is executed in the same wise as in enforced mode. If the timeout period is shorter than the command execution time the EEL\_Execute(&my\_eel\_request) function will return with request-status "busy". The remaining command will be continued time-slice-wise by the EEL\_Handler(t). The timeout mode is intended to be used in synchronous time-slice based systems where each task allocates a fix interval of CPU time for its activity.

Figure 2-17 Schematic illustration of the timeout operation mode

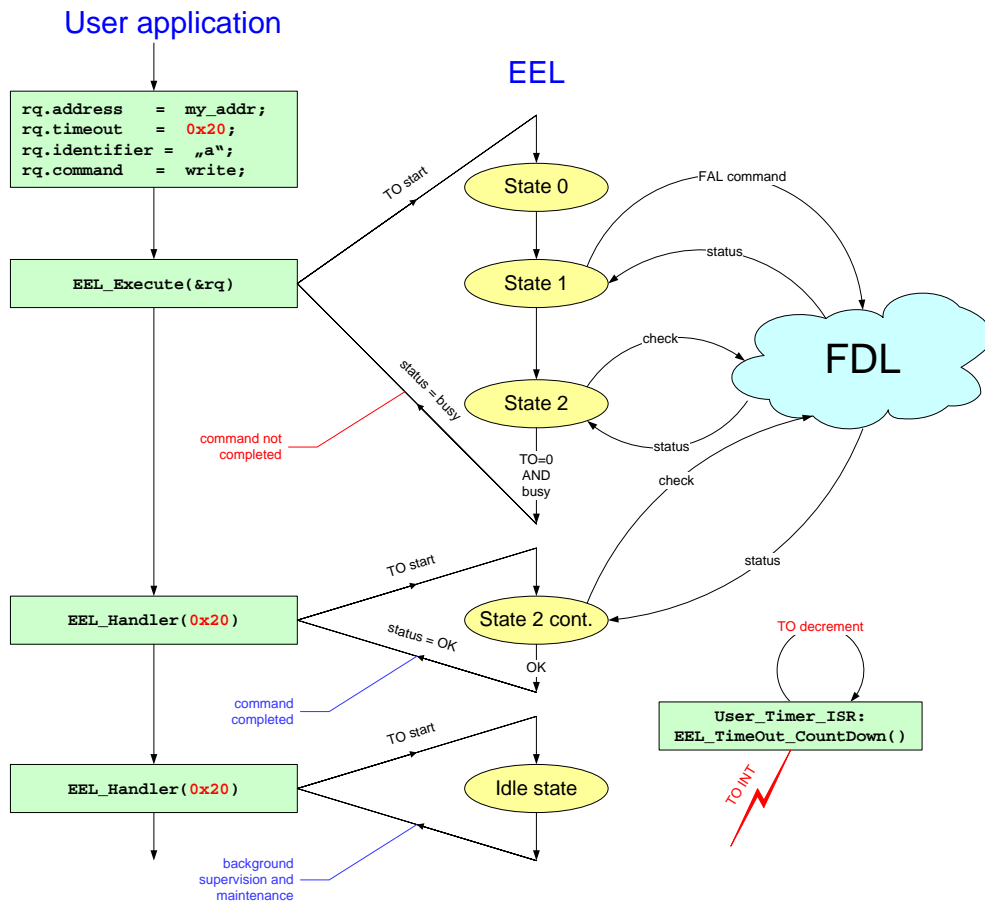

### 2.10.2.1 Command execution finished before timeout

When the timeout period specified in the request variable is longer than the real time needed by the EEL for command execution, the `EEL_Execute(&my_eel_request)` is left immediately after command completion. The EEL does not consume the remaining time during command execution. The reason is, that application normally writes variables asynchronously and wants to write as fast as possible.

Example conditions:

<code>rq.address_pu08</code>	- no meaning for the timing
<code>rq.identifier_u08</code>	- small EEL variable (i.e. 5 bytes)
<code>rq.timeout_u08</code>	- long timeout (16 timer ticks)
<code>rq.command_enu</code>	- always <code>EEL_CMD_WRITE</code> command used
<code>timeslice</code>	- 0x02 used here by <code>EEL_Handler(t)</code> for time-slice

Figure 2-18 Command execution completed before timeout

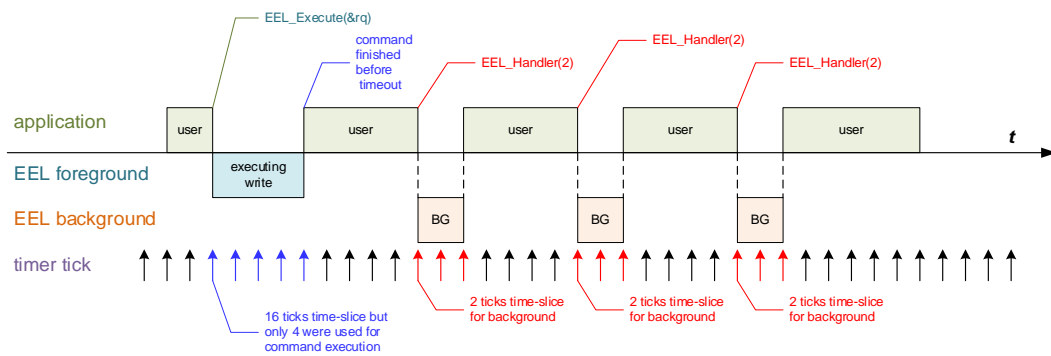

Note:

Black arrows symbolizes non-counting timer ticks (timeout counter is counted down to 0x00).

### 2.10.2.2 Timeout before command execution finished

When the timeout period specified in the request variable is shorter than the real time needed by the EEL for command execution, the `EEL_Execute(&my_eel_request)` is suspended with `status=BUSY`. The uncompleted command must be continued by using the `EEL_Handler(t)` function. When the remaining command is completed before time-slice is passed, the `EEL_Handler(t)` will be terminated immediately. The status inside the request variable changes from busy to finished. EEL does not consume the remaining time of the time-slice when command is finished. The reason is, that application normally writes asynchronously and want to write as fast as possible.

Example conditions:

<code>rq.address_pu08</code>	- no meaning for the timing
<code>rq.identifier_u08</code>	- larger EEL variable (i.e. 125 bytes)
<code>rq.timeout_u08</code>	- execution timeout (5 timer ticks)
<code>rq.command_enu</code>	- always <code>EEL_CMD_WRITE</code> command used
<code>timeslice</code>	- 6 ticks, used here by <code>EEL_Handler(t)</code> for time-slice

Figure 2-19 Command execution completed in `EEL_Handler(t)`

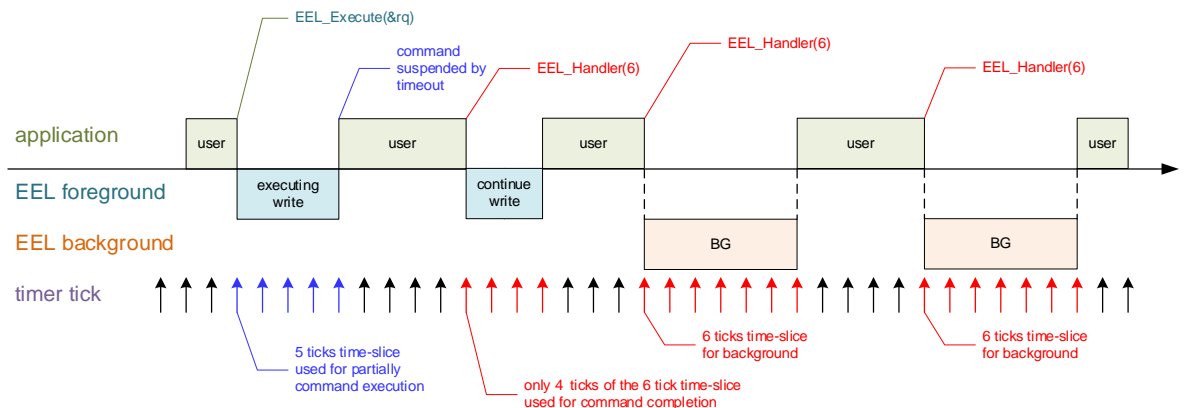

Note:

The 1<sup>st</sup> `EEL_Handler(t)` call continues the command execution. If the command is finished in that time-slice, the `EEL_Handler(t)` will return immediately before timeout is elapsed.

The next `EEL_Handler(t)` calls are managing the BG processes according to the internal status of the EEL-pool:

- when no maintenance \*) is necessary, supervision is running for full 6 ticks
- when any background process (REFRESH/PREPARATION) was interrupted by a write command, it will be continued in `EEL_Handler(t)` after write completion

\*) maintenance means refresh or space expansion



### 2.10.3 Polling execution mode

In the polling execution mode the function `EEL_Execute(&my_eel_request)` is just initiating the command execution and returns with the request-status "busy" after execution of the first internal state. The further command execution is performed in the `EEL_Handler(t)` that can operate with its own timeout period. If calling of `EEL_Handler(0)`, the command execution or background maintenance will be executed state by state. In this operation mode the interaction frequency between the application and the EEL is the highest (fastest reaction). It is intended to be used in asynchronous systems where blocking of the CPU by any process must be minimized.

Note:

When pure polling mode is used in the system `EEL_TimeOut_CountDown()` function becomes mandatory.

Figure 2-20 Schematic illustration of the polling operation mode

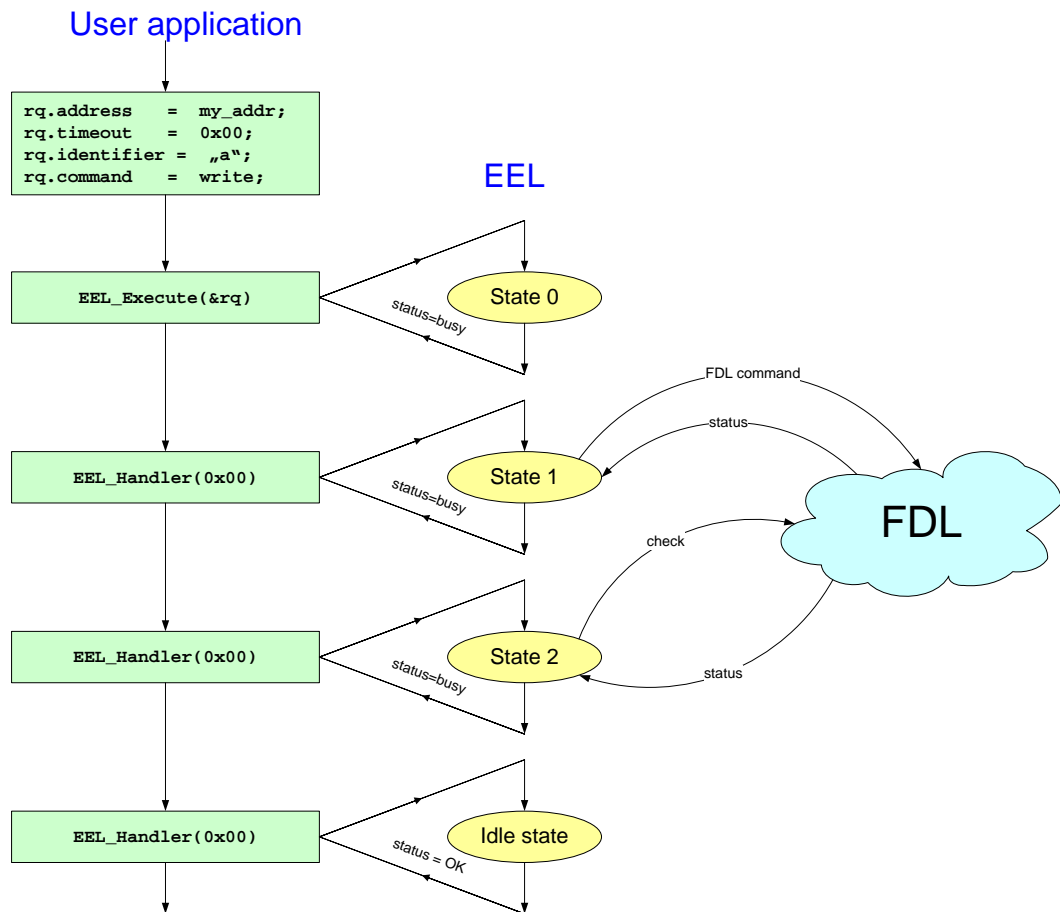

### 2.10.3.1 Full polling execution mode

The timeout parameter in the request variable as well the handler time-slice value are 0x00. The EEL commands, the supervision and maintenance process are executed very smooth, state by state.

Example conditions:

rq.address_pu08	- no meaning for the timing
rq.identifier_u08	- EEL variable
rq.timeout_u08	- 0x00, polling mode
rq.command_enu	- always EEL_CMD_WRITE command used
time-slice	- 0x00, no time-slice for the handler

Figure 2-21 Timing example of pure polling operation

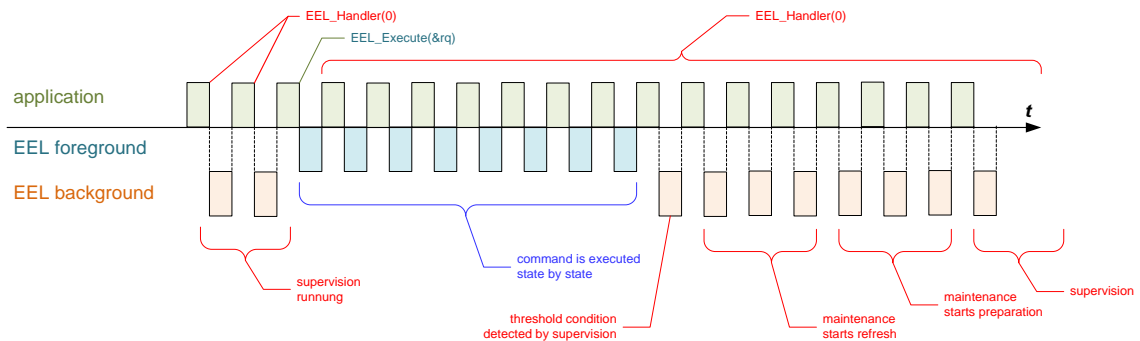

### 2.10.3.2 Mixed execution mode (timeout execution and polling maintenance)

The timeout parameter in the request variable as well the handler time-slice value are 0x00. The EEL commands, the supervision and maintenance process are executed very smooth, state by state.

Example conditions:

rq.address_pu08	- no meaning for the timing
rq.identifier_u08	- EEL variable
rq.timeout_u08	- 0x04, timeout execution
rq.command_enu	- always EEL_CMD_WRITE command used
time-slice	- 0x00, no time-slice for the handler (maintenance)

Figure 2-22 Timing in mixed operation mode (timeout and polling)

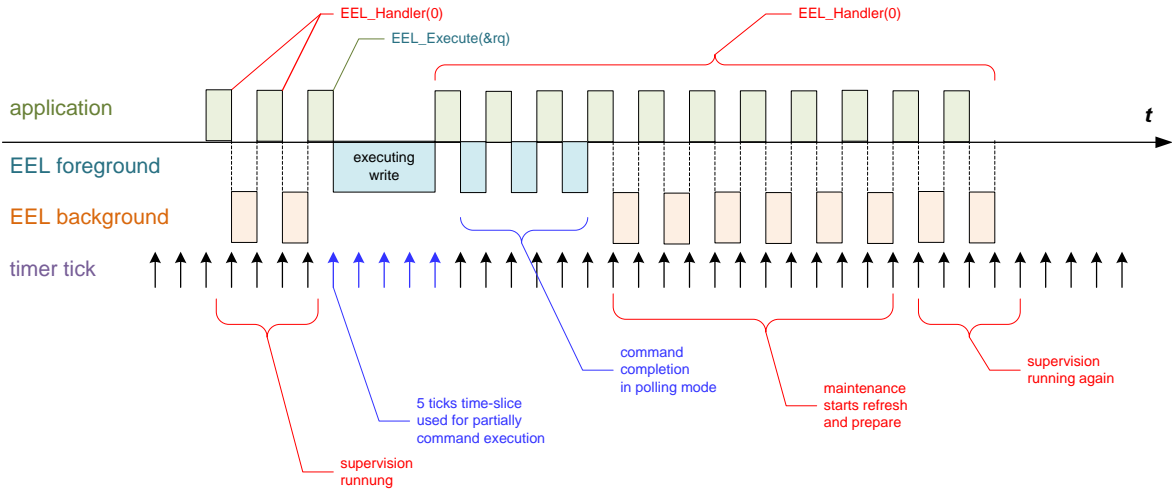

## 2.11 Supported command spectrum

There are two groups of commands supported by the EEL:

- a) pool related commands influencing the whole pool status and structure.
- b) variable related commands that control the access to the EEL data

**Table 2-2 Command groups of the EEL**

Command group	normal operation	exceptional operation
Pool related commands	EEL_CMD_STARTUP	EEL_CMD_CLEANUP
	EEL_CMD_SHUTDOWN	EEL_CMD_FORMAT
Variable related commands	EEL_CMD_READ	-
	EEL_CMD_WRITE	-

Note:

Refer to chapter "Operation" for command execution details

## 2.12 EEL execution planes

The EEL operates in so called two planes: background plane and foreground plane that dedicated to different purposes. The background plane is intended to perform maintenance and supervision work. The foreground plane is used exclusively to perform asynchronous commands requested by the user. Some of the commands require processes already implemented in the background plane. In such cases the foreground is able to activate background processes by swapping the activity focus into the background to perform necessary maintenance measures.

### 2.12.1 Foreground plane

The foreground plane is receiving and executing user commands only. Any foreground command can always suspend the maintenance process running in the background. On the other hand a foreground command has to be finished before next command can be executed.

Variable oriented commands (read and write) are executed directly and completely in the foreground and are normally isolated from the maintenance running in background. Only when space-alert or checksum-error happens in the foreground the process focus is swapped temporary to the background.

Pool oriented commands (startup, shutdown, cleanup and format) are just passing the command-request to the background and waits for its completion. This allows re-usage of common FSM's used for background maintenance and foreground command execution.

In exceptional cases it can happen that due to very heavy write traffic the maintenance process running in background gets no chance to prepare enough space in time. In such a case the foreground write process can request "space expansion" at the background process before being able to continue writing. For that purpose the activity focus is swapped.

Figure 2-23 Swap mechanism scheme

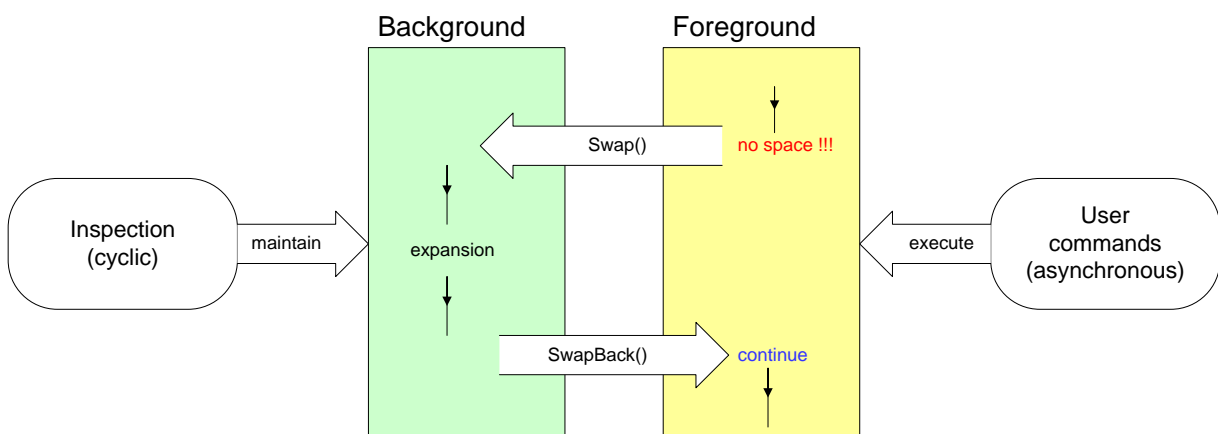

This approach allows collision-free operation even the user do not use the EEL\_Handler(t) and all commands are executed in “enforced” mode. It simplifies the handling at user side without losing any flexibility in the operability. Swapping of execution focus plane does not change the command handling at user side. It is not visible at user side, just the command execution time increases for the time needed for the background processing.

As mentioned above, pool-oriented commands use the background processes for its execution. That means that all error-codes generated in the background must be transferred to the foreground (request variable). There could be errors like FAL\_ERR\_PROTECTION that never happens during normal operation. To simplify the error handling at user side unexpected error codes are transformed to one common error code EEL\_ERR\_INTERNAL. The original error code remains stored in the background and can be read by the function EEL\_GetDriverStatus(&my\_eel\_driver\_status).

### 2.12.2 Background plane

The background plane is dealing with background processes, normally executed when calling the function EEL\_Handler(t) periodically. After EEL initialization the background process is passive (EEL-Handler does not have any effect and consumes, just few CPU cycles). After successful STARTUP the handler becomes active and starts the execution of the background process. There are several task the background process does manage, like:

- a) background execution of pool related commands initiated by the foreground plane
- b) background execution of exceptional handling initiated by the foreground:
  - when less than 2 prepared blocks detected
  - when checksum error during READ command
- c) supervision of the refresh threshold and size of the invalid region
- d) maintenance to eliminate problems detected by c)

## Chapter 3 Application Programming Interface

The following chapters describe formally the user interface of the EEPROM Emulation Library.

### 3.1 Data types

This chapter describes all data definitions used and offered by the EEL.

#### 3.1.1 Library specific simple type definitions

Simple numerical type used by the library:

```
typedef unsigned char      eel_u08;
typedef unsigned int      eel_u16;
typedef unsigned long int eel_u32;
```

Note: types are defined in eel\_types.h

#### 3.1.2 Enumeration type “eel\_command\_t”

This type defines all codes of available commands:

```
/* EEL command set */
typedef enum {
    EEL_CMD_UNDEFINED      = (0x00),
    EEL_CMD_STARTUP       = (0x00 | 0x01),
    EEL_CMD_WRITE         = (0x00 | 0x02),
    EEL_CMD_READ          = (0x00 | 0x03),
    EEL_CMD_CLEANUP       = (0x00 | 0x04),
    EEL_CMD_FORMAT        = (0x00 | 0x05),
    EEL_CMD_SHUTDOWN      = (0x00 | 0x06)
} eel_command_t;
```

Note: type is defined in eel\_types.h

Code value description:

EEL\_CMD\_UNDEFINED - undefined command (initial value)  
 EEL\_CMD\_STARTUP - plausibility check of the EEL data and driver  
 EEL\_CMD\_WRITE - creates new instance of specified EEL variable  
 EEL\_CMD\_READ - reads last instance of the specified EEL variable  
 EEL\_CMD\_CLEANUP - refresh of all variables (minimize active region)  
 EEL\_CMD\_FORMAT - format the EEL pool, all instances (data) are lost  
 EEL\_CMD\_SHUTDOWN - deactivates the EEL

### 3.1.3 Enumeration type “eel\_operation\_status\_t”

This type defines all codes of available driver operation status:

```
/* type of the EEL driver operation status */
typedef enum {
    EEL_OPERATION_PASSIVE      = (0x00),
    EEL_OPERATION_IDLE        = (0x30 | 0x01),
    EEL_OPERATION_BUSY        = (0x30 | 0x02)
} eel_operation_status_t;
```

Note: type is defined in eel\_types.h

Code value description:

EEL\_OPERATION\_PASSIVE - when library is not yet started

EEL\_OPERATION\_IDLE - only background supervision process is active

EEL\_OPERATION\_BUSY - foreground or background process is active

### 3.1.4 Enumeration type “eel\_access\_status\_t”

This type defines all codes of available driver access status:

```
/* type of the access status */
typedef enum {
    EEL_ACCESS_LOCKED          = (0x00),
    EEL_ACCESS_UNLOCKED        = (0x40 | 0x01)
} eel_access_status_t;
```

Note: type is defined in eel\_types.h

Code value description:

EEL\_ACCESS\_LOCKED - neither read nor write access possible

EEL\_ACCESS\_UNLOCKED - full access to the EEL is possible



### 3.1.5 Enumeration type “eel\_status\_t”

This type defines all codes of available request status and errors:

```

/* EEL status set */
typedef enum {
    EEL_OK                = (0x00),
    EEL_BUSY              = (0x00 | 0x01),
    EEL_ERR_CONFIGURATION = (0x80 | 0x02),
    EEL_ERR_INITIALIZATION = (0x80 | 0x03),
    EEL_ERR_ACCESS_LOCKED = (0x80 | 0x04),
    EEL_ERR_COMMAND      = (0x80 | 0x05),
    EEL_ERR_PARAMETER     = (0x80 | 0x06),
    EEL_ERR_REJECTED      = (0x80 | 0x07),
    EEL_ERR_NO_INSTANCE   = (0x80 | 0x08),
    EEL_ERR_POOL_FULL     = (0x80 | 0x09),
    EEL_ERR_POOL_INCONSISTENT = (0x80 | 0x0A),
    EEL_ERR_POOL_EXHAUSTED = (0x80 | 0x0B),
    EEL_ERR_INTERNAL      = (0x80 | 0x0C)
} eel_status_t;

```

Note: type is defined in eel\_types.h

Code value description:

EEL_OK	- no error occurred
EEL_BUSY	- request is under processing
EEL_ERR_CONFIGURATION	- bad FAL or EEL configuration
EEL_ERR_INITIALIZATION	- EEL_Init(), EEL_Open missed
EEL_ERR_ACCESS_LOCKED	- STARTUP missing or fatal operation error
EEL_ERR_COMMAND	- wrong command code
EEL_ERR_PARAMETER	- wrong parameter
EEL_ERR_REJECTED	- another request under processing
EEL_ERR_NO_INSTANCE	- no instance found (variable never written)
EEL_ERR_POOL_FULL	- no space for writing data
EEL_ERR_POOL_INCONSISTENT	- no active block found within EEL-pool
EEL_ERR_POOL_EXHAUSTED	- EEL pool too small for correct operation
EEL_ERR_INTERNAL	- internal error

### 3.1.6 Structured type “eel\_request\_t”

This type defines structure of the EEL request variables:

```
/* EEL request type */
typedef __near struct {
    __near eel_u08*      address_pu08;
    __near eel_u08      identifier_u08;
    __near eel_u08      timeout_u08;
    __near eel_command_t command_enu;
    __near eel_status_t status_enu;
} eel_request_t;
```

Note: type is defined in eel\_types.h

Structure member description:

address_pu08	- source/destination RAM-address
identifier_u08	- variable identifier
timeout_u08;	- number of timeout ticks for execution
command_enu;	- command has to be processed
status_enu;	- error code after command execution

### 3.1.7 Structured type “eel\_driver\_status\_t”

This type defines structure of the EEL request variables:

```
/* type of the internal EEL driver status */
typedef struct {
    eel_operation_status_t operationStatus_enu;
    eel_access_status_t    accessStatus_enu;
    eel_status_t           backgroundStatus_enu;
} eel_driver_status_t;
```

Note: type defined in eel\_types.h

Structure member description:

operationStatus_enu	- operation status of the foreground process
accessStatus_enu	- access rights indicator
backgroundStatus_enu	- error status of the background process

## 3.2 Functions

Due to the request (data) oriented interface of the EEL the functional interface is very narrow. Beside the initialization function and some administrative function the whole EEPROM access is concentrated to two functions only: **EEL\_Execute(&my\_eel\_request)** and **EEL\_Handler(t)**.

The interface functions create the functional software interface of the library. They are prototyped in the header file eel.h

### 3.2.1 EEL\_Init

Initialization of all internal data and variables.

#### C interface for CA78K0R compiler

```
eel_status_t __far EEL_Init(void);
```

#### C interface for IAR V1.xx compiler

```
__far_func eel_status_t EEL_Init(void);
```

#### C interface for IAR V2.xx compiler

```
__far_func eel_status_t EEL_Init(void);
```

#### Pre-condition

The FDL must be initialized already

#### Post-condition

None

#### Argument

Argument	Type	Description
none		

#### Return types/values

Value	Type	Description
EEL_OK	eel_status_t	when EEL pool and descriptor OK
EEL_ERR_CONFIGURATION	eel_status_t	when EEL pool or EEL descriptor wrong

#### Code example:

```
eel_status_t my_eel_status;

my_eel_status = EEL_Init();
if(my_eel_status != EEL_OK) MyErrorHandler();
```

### 3.2.2 EEL\_Open

This function can be used by the application to open the access to the EEL pool.

#### C interface for CA78K0R compiler

```
void __far EEL_Open(void);
```

#### C interface for IAR V1.xx compiler

```
__far_func void EEL_Open(void);
```

#### C interface for IAR V2.xx compiler

```
__far_func void EEL_Open(void);
```

#### Pre-condition

The FDL must be initialized already

#### Post-condition

none

#### Argument

Argument	Type	Description
none		

#### Return types/values

Value	Type	Description
none		

#### Code example:

```
EEL_Open();
```

### 3.2.3 EEL\_Close

This function can be used by the application to close the access to the EEL pool.

#### C interface for CA78K0R compiler

```
void __far EEL_Close(void);
```

#### C interface for IAR V1.xx compiler

```
__far_func void EEL_Close(void);
```

#### C interface for IAR V2.xx compiler

```
__far_func void EEL_Close(void);
```

#### Pre-condition

None

#### Post-condition

In case that the USER part of the FDL-pool also “opened” too at that time, the Data Flash hardware remains active. To switch the Data Flash passive, both parts of the FAL-pool (EEL-part and USER-part) has to be closed.

#### Argument

Argument	Type	Description
none		

#### Return types/values

Value	Type	Description
none		

#### Code example:

```
EEL_Close();
```

### 3.2.4 EEL\_Execute

This is one of the main function of the EEL the application can use to initiate execution of any command. Depending on the defined operation mode (time out value) this function returns:

- a) immediately after execution of the first command state (timeout = 0)
- b) after execution of the defined time-slice (0<timeout<255)
- c) after execution of the complete command (timeout = 255)

#### C interface for CA78K0R compiler

```
void __far EEL_Execute(eel_request_t* request_pstr);
```

#### C interface for IAR V1.xx compiler

```
__far_func void EEL_Execute(__near eel_request_t __near*  
                           request_pstr);
```

#### C interface for IAR V2.xx compiler

```
__far_func void EEL_Execute(eel_request_t __near *  
                           request_pstr);
```

#### Pre-condition

EEL\_Init() executed successfully  
EEL\_Open() must be executed before.

#### Post-condition

none

#### Argument

Argument	Type	Description
request_pstr	eel_request_t*	This argument defines user's request should be processed by the EEL. It is passing the request variable to the driver that is used for bi-directional information exchange before and during command execution between EEL and the application.

## Return types/values

Value	Type	Description
none		

## Code example:

```

eel_request_t    my_eel_request_str;
eel_status_t    my_eel_status;

my_eel_status = EEL_Init();
EEL_Open();

/* enforced mode ----- */
my_eel_request_str.timeout_u08      = 0xFF;
my_eel_request_str.command_enu      = EEL_CMD_STARTUP;

EEL_Execute(&my_eel_request_str);
if(my_eel_request_str.status_enu != EEL_OK) MyErrorHandler();

/* timeout mode ----- */
my_eel_request_str.timeout_u08      = 5;
my_eel_request_str.command_enu      = EEL_CMD_FORMAT;

do {
    EEL_Execute(&my_eel_request_str);
    EEL_Handler(0);
}while(my_eel_request_str.status_enu == EEL_ERR_REJECTED);

do {
    EEL_Handler(5);
while(my_eel_request_str.status_enu == EEL_ERR_BUSY);

if(my_eel_request_str.status_enu != EEL_OK) MyErrorHandler();

/* STARTUP after FORMAT mandatory (enforced mode)----- */
my_eel_request_str.timeout_u08      = 0xFF;
my_eel_request_str.command_enu      = EEL_CMD_STARTUP;

EEL_Execute(&my_eel_request_str);
if(my_eel_request_str.status_enu != EEL_OK) MyErrorHandler();

/* polling mode ----- */
my_eel_request_str.address_pu08     = (eel_u08)&A[0];
my_eel_request_str.identifier_u08   = 'A';
my_eel_request_str.timeout_u08      = 0;
my_eel_request_str.command_enu      = EEL_CMD_WRITE;

do {
    EEL_Execute(&my_eel_request_str);
    EEL_Handler(0);
}while(my_eel_request_str.status_enu == EEL_ERR_REJECTED);

do {
    EEL_Handler(0);
while(my_eel_request_str.status_enu == EEL_ERR_BUSY);

if(my_eel_status != EEL_OK) MyErrorHandler();

```

### 3.2.5 EEL\_Handler

Depending on internal status of the EEL this function is managing different processes as follows:

a)

When no user command is processed in the foreground, the EEL\_Handler(t) is executing the internal maintenance process. It is monitoring permanently the size of the “active region” to trigger the “refresh process” when exceeded the defined EEL\_REFRESH\_BLOCK\_THRESHOLD. On the other side “preparation process” is triggered in the background whenever an invalid block is found in the EEL pool. Finally it checks if any requests from the foreground are pending in the meantime.

b)

If a foreground command is not finished in “timeout” or “polling” mode the EEL\_Handler(t) takes care for continuation of the execution of not-finished commands in the next time-slices.

#### C interface for CA78K0R compiler

```
void __far EEL_Handler(eel_u08 timeout_u08);
```

#### C interface for IAR V1.xx compiler

```
__far_func void EEL_Handler(eel_u08 timeout_u08);
```

#### C interface for IAR V2.xx compiler

```
__far_func void EEL_Handler(eel_u08 timeout_u08);
```

#### Pre-condition

EEL initialized and opened

#### Post-condition

None



**Argument**

Argument	Type	Description
timeout_u08	eel_u08	<p>Timeout value expressed in ticks.</p> <p>If timeout_u08=0 only one state of the internal FSM will be executed.</p> <p>If timeout_u08&lt;&gt;0 internal states are executed as long the timeout counter&gt;0.</p>

**Return types/values**

Value	Type	Description
none		

**Code example:**

```

/* The best place for EEL_Handler is the scheduler loop */
eel_u08  my_time_slice;

my_time_slice = 0x00;
do {
    EEL_Handler(my_time_slice);
    User_Task_A();
    User_Task_B();
    User_Task_C();
    User_Task_D();
} while(true);

```

### 3.2.6 EEL\_TimeOut\_CountDown

This function counts the internal 8-bit timeout counter down to zero. When executing a command, the program counter remains inside the EEL\_Execute(&my\_eel\_request) or EEL\_Handler(t) as long this counter>0. The EEL\_TimeOut\_CountDown() function can be called at any place in the application. The preferable place is any periodical interrupt service routine, for example the timer ISR of the operating system. When the internal 8-bit timer achieve the value 0x00 the EEL\_TimeOut\_CountDown() function stops the counting. The counter starts counting again when a new "timeout" request was placed via EEL\_Execute(&my\_eel\_request) or when EEL\_Handler(t) was called with t>0.

#### C interface for CA78K0R compiler

```
void __far EEL_TimeOut_CountDown(void);
```

#### C interface for IAR V1.xx compiler

```
__far_func void EEL_TimeOut_CountDown(void);
```

#### C interface for IAR V2.xx compiler

```
__far_func void EEL_TimeOut_CountDown(void);
```

#### Pre-condition

none

#### Post-condition

Timeout counter decremented in case it was running.

#### Argument

Argument	Type	Description
none		

#### Return types/values

Value	Type	Description
none		

#### Code example:

```
#pragma interrupt INTTM00 isr_OS_timer

void isr_OS_timer(void)
{
    EEL_TimeOut_CountDown();
}
```

### 3.2.7 EEL\_GetDriverStatus

This function opens a way to check the internal status of the EEL driver in advance, before placing a request.

#### C interface for CA78K0R compiler

```
void __far EEL_GetDriverStatus(__near eel_driver_status_t*
                               driverStatus_pstr);
```

#### C interface for IAR V1.xx compiler

```
__far_func void EEL_GetDriverStatus(__near eel_driver_status_t
                                     __near* driverStatus_pstr);
```

#### C interface for IAR V2.xx compiler

```
__far_func void EEL_GetDriverStatus(eel_driver_status_t
                                     __near * driverStatus_pstr);
```

#### Pre-condition

EEL initialized and opened

#### Post-condition

none

**Argument**

Argument	Type	Description
driverStatus_pstr	eel_driver_status_t*	This argument is a placeholder for capturing the internal status of the driver. It indicates the operation status, the access status and the status of the background process of the EEL.
EEL_OPERATION_PASSIVE	driverStatus_pstr->operationStatus_enu	EEL not initialized or not opened or not started-up successfully. Operation and access to the data is not possible.
EEL_OPERATION_IDLE		After successful STARTUP when neither foreground command nor background maintenance is active.
EEL_OPERATION_BUSY		EEL is processing an user command or when maintenance process is active in background. Other commands are not possible at that time.
EEL_ACCESS_LOCKED	driverStatus_pstr->accessStatus_enu	STARTUP not executed/successful or access to data-flash was locked by the EEL due to any internal problems.
EEL_ACCESS_UNLOCKED		STARTUP executed successfully, read/write access to the EEL-pool is possible
any	driverStatus_pstr->backgroundStatus_enu	Any value of the eel_status_t related to background processes are possible. It will be actualized/overwritten by the background process only. The usage of it is quite limited.

**Return types/values**

Value	Type	Description
none		

**Code example:**

```

eel_request_t          my_eel_request_str;
eel_status_t          my_eel_status_enu;
eel_driver_status_t   my_eel_driver_status_str;

my_eel_status_enu = EEL_Init();
EEL_Open();

/* execute STARTUP if not already done */
EEL_GetDriverStatus(&my_eel_driver_status_str);
if(my_eel_driver_status_str.operationStatus_enu==EEL_OPERATION_P
ASSIVE)
{
    my_eel_request_str.timeout_u08          = 0xFF;
    my_eel_request_str.command_enu         = EEL_CMD_STARTUP;

    EEL_Execute(&my_eel_request_str);
    if(my_eel_request_str.status_enu != EEL_OK) MyErrorHandler();
}

/* write data when access already possible */
EEL_GetDriverStatus(&my_eel_driver_status_str);
if(my_eel_driver_status_str.accessStatus_enu==EEL_ACCESS_UNLOCKED)
{
    my_eel_request_str.address_pu08       = (eel_u08)&A[0];
    my_eel_request_str.identifier_u08     = 'A';
    my_eel_request_str.timeout_u08       = 0;
    my_eel_request_str.command_enu       = EEL_CMD_WRITE;

    do {
        EEL_Execute(&my_eel_request_str);
        EEL_Handler(0);
    }while(my_eel_request_str.status_enu==EEL_ERR_REJECTED);

    do {
        EEL_Handler(0);
    }while(my_eel_request_str.status_enu==EEL_ERR_BUSY);

    if(my_eel_request_str.status_enu != EEL_OK) MyErrorHandler();
}

```

### 3.2.8 EEL\_GetSpace

This function provides the number of flash words inside the active-head and the prepared region that can still absorb new references and data.

#### C interface for CA78K0R compiler

```
eel_status_t __far EEL_GetSpace(__near eel_u16* space_pu16);
```

#### C interface for IAR V1.xx compiler

```
__far_func eel_status_t EEL_GetSpace(__near eel_u16 __near*
                                     space_pu16);
```

#### C interface for IAR V2.xx compiler

```
__far_func eel_status_t EEL_GetSpace(eel_u16 __near *
                                     space_pu16);
```

#### Pre-condition

EEL must be initialized, opened and STARTUP must be executed before space can be calculated

#### Post-condition

none

#### Argument

Argument	Type	Description
space_pu16	eel_u16*	Address of the space information variable

#### Return types/values

Value	Type	Description
EEL_OK	eel_status_t	When space value is correct
EEL_ERR_INITIALIZATION	eel_status_t	When EEL_Init() or EEL_Open() is missing
EEL_ERR_ACCESS_LOCKED	eel_status_t	when STARTUP command missing
EEL_ERR_REJECTED	eel_status_t	when space not stable, just being modified.

**Code example:**

```
eel_request_t          my_eel_request_str;
eel_status_t          my_eel_status_enu;
eel_u16               my_eel_space_u16;

my_eel_status = EEL_Init();
EEL_Open();

/* execute STARTUP if not already done */
EEL_GetDriverStatus(&my_eel_driver_status_str);
if(my_eel_driver_status_str.operationStatus_enu==EEL_OPERATION_P
ASSIVE)
{
    my_eel_request_str.timeout_u08      = 0xFF;
    my_eel_request_str.command_enu     = EEL_CMD_STARTUP;

    EEL_Execute(&my_eel_request_str);
    if(my_eel_request_str.status_enu != EEL_OK) MyErrorHandler();
}

/* read current space value */
my_eel_status_enu = EEL_GetSpace(&my_eel_space_u16);

if(my_eel_status_enu==EEL_OK)
{
    if(my_eel_space_u16<MY_SPACE_ALERT_THRESHOLD)
    {
        my_eel_request_str.timeout_u08      = 0xFF;
        my_eel_request_str.command_enu     = EEL_CMD_CLEANUP;

        EEL_Execute(&my_eel_request_str);
        if(my_eel_request_str.status_enu!=EEL_OK) MyErrorHandler();
    }
}
else
{
    MyErrorHandler();
}
```

### 3.2.9 EEL\_GetVersionString

This function can be used by the application to check and control the library version information at runtime.

#### C interface for CA78K0R compiler

```
__far eel_u08* __far EEL_GetVersionString(void);
```

#### C interface for IAR V1.xx compiler

```
__far_func eel_u08 __far* EEL_GetVersionString(void);
```

#### C interface for IAR V2.xx compiler

```
__far_func eel_u08 __far * EEL_GetVersionString(void);
```

#### Pre-condition

none

#### Post-condition

none

#### Argument

Argument	Type	Description
none		

#### Return types/values

Value	Type	Description
	__far eel_u08*	pointer to the first character of the zero-terminated library version string.

#### Code example:

```
__far eel_u08* my_version_string_pu08;

my_version_string_pu08 = EEL_GetVersionString();

PrintMyVersion(&my_version_string_pu08);
```



## Description of the version string

For version control at runtime the developer can use this function to find the starting character of the library version string (ASCII format).

The version string is a zero-terminated string constant that covers library-specific information and is based on the following structure: NMMMMTTTCCCCGVVV..V, where:

- N : library type specifier (here 'E' for EEL)
- MMMM : series name of microcontroller (here 'RL78')
- TTT : type number (here 'T01')
- CCCCC : compiler information (4 or 5 characters)
  - 'Rxyy' for CA78K0R compiler
  - 'lxyy' for IAR V1.xx compiler
  - 'Lxyyz' for IAR V2.xx compiler
- G : all memory models (here 'G' for general)
- VVV..V : library version
  - 'Vxyy' for release version x.yy
  - 'Exyyy' for engineering version x.yyy

Examples:

The version string of the EEL V1.15 for the CA78K0R compiler is:  
"ERL78T01R110GV115"

The version string of the EEL V1.15 for the IAR V1.xx compiler is:  
"ERL78T01I120GV115"

The version string of the EEL V1.15 for the IAR V2.xx compiler is:  
"ERL78T01L1000GV115"

## Chapter 4 Operation

This chapter describes the installation, integration, configuration and of the EEPROM Emulation library.

### 4.1 Obtaining the Library

The EEL T01 is provided by means of an installer via the Renesas homepage at [http://www.renesas.eu/updates?oc=EEPROM\\_EMULATION\\_RL78](http://www.renesas.eu/updates?oc=EEPROM_EMULATION_RL78). Please follow the instructions of the installer carefully and read this user manual which is also available there. For operation, the EEL T01 requires the corresponding FDL (RL78 FDL Type T01). Please ensure to always work on the latest version of both libraries.

### 4.2 Installation

All components of the EEPROM Library package are extracted by the self extracting installer file **RENESAS\_RL78\_EEL-FDL\_T01\_PACK01\_xVxx.exe**

After acceptance of the license the library for the required tool chain can be selected.

#### 4.2.1 File Structure

The main file of the installed library package is the pre-compiled EEL. The header and include files defining the API as well the descriptor files are available in source form.

Table 4-1: Common files of the EEL T01

File	Description
<b>&lt;installation folder&gt;</b>	
Release.txt	contains release-specific information about the installed library
support.txt	library support information

Table 4-2: File structure of the EEL T01 for CA78K0R tool chain

<b>&lt;installation folder&gt;/CA78K0R_xxx/EEL/lib</b>	
eel.h	EEL header file, EEL interface definition
eel_types.h	EEL header file, EEL types definition
eel.inc	EEL assembler include file with interface definition
eel_types.inc	EEL assembler include file with EEL types definition
eel.lib	precompiled library file
<b>&lt;installation folder&gt;/CA78K0R_xxx/EEL/Sample/C</b>	
eel_descriptor.c	user defined EEL-variable descriptor
eel_descriptor.h	EEL configuration part
eel_user_types.h	sample user types for EEL variables
eel_sample_linker_file.dr	linker sample file

<b>&lt;installation folder&gt;/CA78K0R_xxx/EEL/Sample/asm</b>	
eel_descriptor.asm	user defined EEL-variable descriptor and sample user types
eel_descriptor.inc	EEL configuration part
eel_sample_linker_file.dr	linker sample file

Table 4-3: File structure of the EEL T01 for IAR V1.xx tool chain

<b>&lt;installation folder&gt;/IAR_1xx/EEL/lib</b>	
eel.h	EEL header file, EEL interface definition
eel_types.h	EEL header file, EEL types definition
eel.r87	precompiled library file
<b>&lt;installation folder&gt;/IAR_1xx/EEL/Sample/C</b>	
eel_descriptor.c	user defined EEL-variable descriptor
eel_descriptor.h	EEL configuration part
eel_user_types.h	sample user types for EEL variables
eel_sample_linker_file.xcl	linker sample file

Table 4-4: File structure of the EEL T01 for IAR V2.xx tool chain

<b>&lt;installation folder&gt;/IAR_2xx/EEL/lib</b>	
eel.h	EEL header file, EEL interface definition
eel_types.h	EEL header file, EEL types definition
eel.a	precompiled library file
<b>&lt;installation folder&gt;/IAR_2xx/EEL/Sample/C</b>	
eel_descriptor.c	user defined EEL-variable descriptor
eel_descriptor.h	EEL configuration part
eel_user_types.h	sample user types for EEL variables
eel_sample_linker_file.icf	linker sample file

### 4.3 Basic workflow

To be able to use the EEL (execute commands) in a proper way the user has to follow a specific startup and shutdown procedure.

Figure 4-1 Basic workflow of the EEL

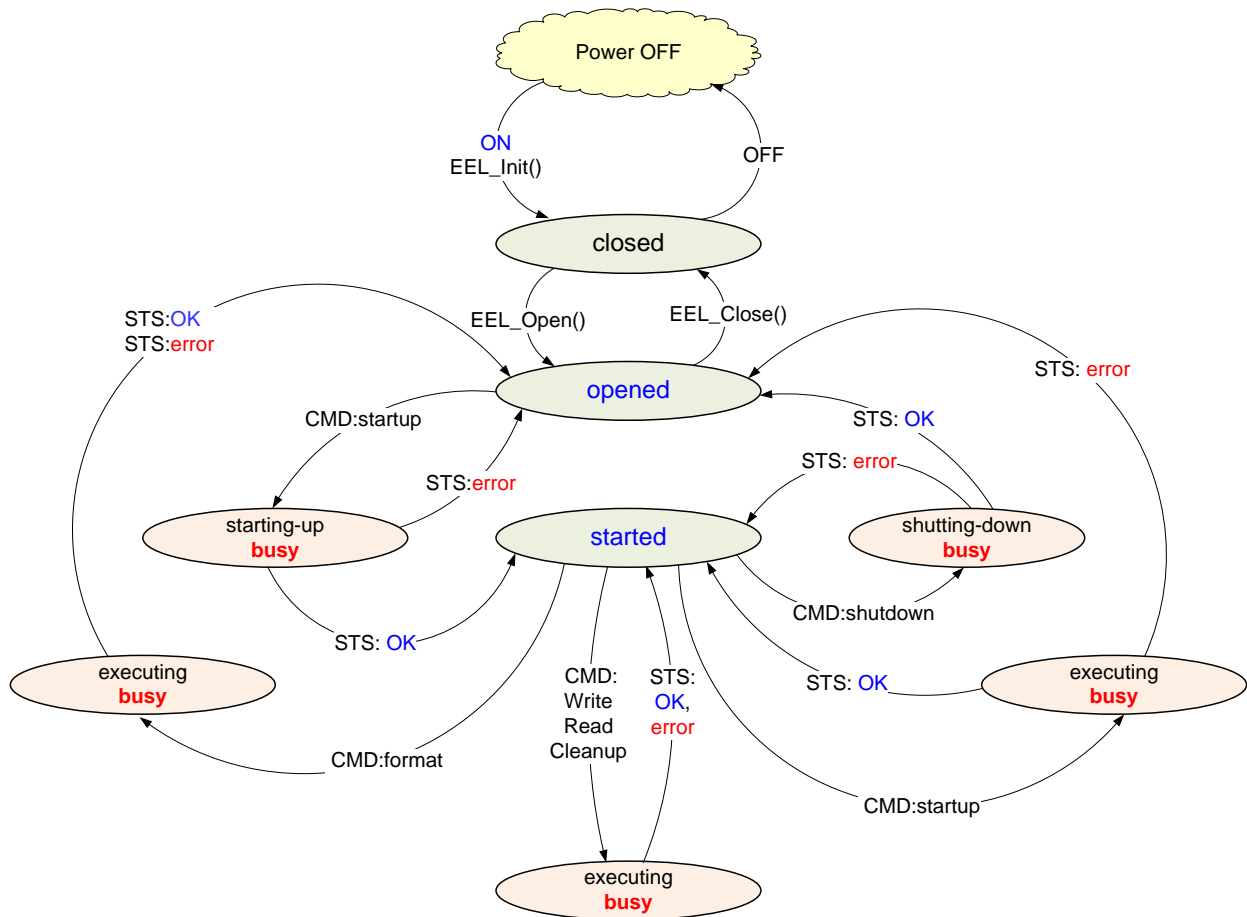

Notes:

- 1 - The FORMAT command can be executed without successful STARTUP
- 2 - After execution of the FORMAT command the EEL goes into state "opened", so STARTUP command must be executed again .

## 4.4 Configuration

The EEL configuration can be divided into two stages:

- configuration of the EEL pool in the FAL-descriptor
- configuration of the EEL variables in EEL-descriptor

### 4.4.1 Pool configuration

The size of the EEL pool is configured in the FAL\_descriptor files. The minimum size of the EEL-pool is 4 blocks (1 active, 1 prepared, 1 being erased and one potentially excluded). This is the virgin condition. At runtime the EEL must be able to work with at least 1 excluded block.

#### File fdl\_descriptor.h

```
EEL_POOL_SIZE 6      /* specify number of EEL blocks, min 4 */
```

Note:

EEL\_POOL\_SIZE should not exceed the FAL\_POOL\_SIZE

#### File eel\_descriptor.h

```
EEL_STORAGE_TYPE    'D'    /* determines flash medium */
```

'D'                    - Data Flash and FDL in use  
other values         - invalid

```
EEL_REFRESH_BLOCK_THRESHOLD 3 /* determines refresh threshold */
```

Note:

It is not easy to develop a precise and certain formula for the refresh-threshold because the order of written/refreshed instances in the active-region is a random process decided at runtime. Good results can be achieved when defining the threshold to  $(N + 1)$  where  $N$  is the number of blocks needed for coverage of all initial instances of all variables declared in EEL descriptor. Generally the bigger the prepared region the smoother is the run-time operation of the EEL. Therefore the threshold should be minimized in relationship to the amount of data.

**It is strongly recommend to check the runtime behavior of the EEL at a given configuration in the target system under worst case conditions (variable size, variable number, threshold, pool-size, block exclusion, writing speed...) before establishing and releasing the configuration.**

#### 4.4.2 Endurance Calculation

Every write operation of a new EEL variable instance occupies space in the Data Flash. Whenever the active block is full, the current variable set needs to be copied to a new block by means of the refresh operation during which the target block is erased (see also Section 2.4).

This process is repeated many times over the device lifetime. However, the endurance of the Data Flash blocks regarding the number of erase cycles is limited. Hence, it is necessary to calculate the application-specific number of erase cycles required over the device lifetime and to ensure that the specified Data Flash endurance is not exceeded.

Renesas provides an endurance calculation sheet which can be filled with the different data sets sizes and the required write cycles. The sheet can estimate the expected number of Flash erase cycles and indicate an exceedance of the Data Flash specification. Thereby, the number of available EEL blocks has a major impact the overall endurance of the pool. By using varying numbers of EEL blocks for the calculation, the required number of EEL blocks can be derived for the target application scenario.

Note:

The endurance calculation sheet is a very helpful tool. However, please note that the result is only an estimate and the sheet cannot produce absolutely accurate numbers. The exact endurance depends on additional constraints—like for instance the write sequence of the variables—which are not captured by the sheet. Therefore, any result of the endurance calculation sheet must be confirmed in the actual user application.

The calculation sheet can be obtained from the Renesas Flash support, which can be contacted via Email at the following address: [application\\_support.flash-eu@lm.renesas.com](mailto:application_support.flash-eu@lm.renesas.com).

#### 4.4.3 Variable configuration

The number and size of variable managed by the EEL are configured in the `eel_descriptor` files. The EEL driver/library can only read/write variable-ID's registered in the EEL-descriptor.

##### File `eel_descriptor.h`

```
EEL_VAR_NO    8    /* number of variables handled by EEL, min 1 */
```

##### File `eel_descriptor.c`

```
/* EEL variable size expressed in bytes */
#define bsize_A (sizeof(type_A))
#define bsize_B (sizeof(type_B))
#define bsize_C (sizeof(type_C))
#define bsize_D (sizeof(type_D))
#define bsize_E (sizeof(type_E))
#define bsize_F (sizeof(type_F))
#define bsize_X (sizeof(type_X))
#define bsize_Z (sizeof(type_Z))

/* EEL variable size expressed in words */
#define wsize_A (bsize_A+3)/4
#define wsize_B (bsize_B+3)/4
#define wsize_C (bsize_C+3)/4
#define wsize_D (bsize_D+3)/4
#define wsize_E (bsize_E+3)/4
#define wsize_F (bsize_F+3)/4
#define wsize_X (bsize_X+3)/4
#define wsize_Z (bsize_Z+3)/4
```

```

__far const eel_u08 eel_descriptor[EEL_VAR_NO+1][4] =
{
/*identifier      word-size (1..64)  byte-size (1..255)  RAM-Ref.  */
/*-----*/
(eel_u08)'a', (eel_u08)(wsize_A), (eel_u08)(bsize_A), 0x01, \
(eel_u08)'b', (eel_u08)(wsize_B), (eel_u08)(bsize_B), 0x01, \
(eel_u08)'c', (eel_u08)(wsize_C), (eel_u08)(bsize_C), 0x01, \
(eel_u08)'d', (eel_u08)(wsize_D), (eel_u08)(bsize_D), 0x01, \
(eel_u08)'e', (eel_u08)(wsize_E), (eel_u08)(bsize_E), 0x01, \
(eel_u08)'f', (eel_u08)(wsize_F), (eel_u08)(bsize_F), 0x01, \
(eel_u08)'x', (eel_u08)(wsize_X), (eel_u08)(bsize_X), 0x01, \
(eel_u08)'z', (eel_u08)(wsize_Z), (eel_u08)(bsize_Z), 0x01, \
0x00,      0x00,      0x00,      0x00, \
};

```

The EEL descriptor is a [N+1] vector containing descriptor information of each EEL variable (N is the total number of EEL variables registered).

Each variable descriptor is an array of 4 bytes.

The EEL descriptor must be terminated by a descriptor terminator (4 bytes 0x00). This pattern is used internally by the EEL as descriptor-end-criteria in the variable searching process.

**Identifier:**

The 1<sup>st</sup> byte of the variable descriptor is the “identifier” field that must be unique within the whole EEL-descriptor. Variables can be identified, read and written by using this identifier.

**Word-size:**

The 2<sup>nd</sup> byte of the variable descriptor specifies the size of the variable expressed in words.

**Byte-size:**

The 3<sup>rd</sup> byte of the variable descriptor specifies the size of the variable expressed in bytes.

**RAM-ref:**

The 4<sup>th</sup> byte of the variable descriptor is the “RAM-reference” which should indicate EEL variables referenced by RAM-reference. This field is only relevant when EEL is using the FCL for flash access. When FDL is accessing the flash, the “RAM-reference” files doesn’t have any meaning (in that case each variable is referenced by RAM automatically).

#### 4.4.4 EEL Variable Initialization

Before being able to regularly use the Data Flash for EEPROM emulation, the EEL pool must be formatted and—depending on the application—be filled with initial values for the EEL variables. This can be done using different approaches. Two very common ways are presented in the following:

- The application itself executes the format operation and then writes initial instances of the variables. As the format operation deletes all data, it needs to be carefully considered in this scenario how to prevent accidental pool formatting by the application.
- A serial programming tool (e.g. PG-FP5) or debugger is used to program the Data Flash in the same flow that also programs the Code Flash.

For the later approach (using a programming tool or a debugger), a hex file is required which contains the Data Flash content (i.e. the complete EEL pool in raw format). This content can be gained by

- dumping the content of the Data Flash with an already formatted EEL pool into a hex file using a serial programming tool or the debugger, or by
- using a tool chain of Data Flash Converter and/or Data Flash Editor to convert EEL variable values into a hex file.

Data Flash Converter and Data Flash Editor can be obtained from the following URLs (including dedicated user manuals):

- <http://www.renesas.eu/updates?oc=DATAFLASHCONVERTER>
- <http://www.renesas.eu/updates?oc=DATAFLASHEDITOR>

#### 4.4.5 Pool configuration hints and tips

During operation the situation in the EEL-pool changes whenever data are written into it. This is a high dynamic, unpredictable random process. On the other hand each application has different timing requirements when writing data. Some application need so called burst write (writing many data in relatively short time e.g. crash data in airbag applications). Other applications have to write data permanently in equidistant intervals like odometer in automotive applications. Moreover the size of variables and its individual write cycles and writing frequency may influence the real write-time.

When writing data into the EEL-pool three different cases are possible:

- 1) enough space for the instance and its reference exists in active head
- 2) not enough space in active head but more than 2 prepared blocks exist.
- 3) not enough space in active head but less than 3 prepared blocks exist.

In case 1) the execution time of the WRITE command consists of the pure writing-time only:

$$T_1(\text{WRITE}) = t(\text{write}).$$

In case 2) the execution time of the WRITE command consists of two components: the activation-time and writing-time:

$$T_2(\text{WRITE}) = t(\text{activation}) + t(\text{write}).$$

In case 3) the execution time of the WRITE command consists of three components: the expansion-time, activation-time and writing-time:

$$T_3(\text{WRITE}) = t(\text{expand}) + t(\text{activation}) + t(\text{write}).$$

Where:  $T_1(\text{WRITE}) < T_2(\text{WRITE}) \lll T_3(\text{WRITE})$

The difference between  $T_1(\text{WRITE})$  and  $T_2(\text{WRITE})$  is very small and cannot/mustn't be avoided by the user (system architecture related behavior).

The  $T_3(\text{WRITE})$  is much longer than  $T_1/T_2(\text{WRITE})$  because it incorporates block erase time. Consequently to keep writing-time constant during EEL operation the user should avoid situation described in case 3) by keeping the background maintenance alive. When calling the `EEL_Handler(t)` permanently in the application idle loop the EEL will automatically remove conditions described in case 3) according to the EEL-pool configuration.



There are some general dependencies that should be taken into account when configuring the EEL and its pool.

- 1) the bigger the prepared area B(P) the better the real time performance
- 2) the bigger the S(F) the better (more efficient) the usage of erase cycles
- 3) the refresh threshold should be max. 1 block bigger than S(D)

In below examples following abbreviations were used:

B(P) – number of prepared blocks in initially programmed EEL-pool  
 B(D) – number of blocks containing initial data  
 S(H) – size of block header expressed in flash words  
 S(R) – size of the initial reference area in the active heading block in words  
 S(F) – size of the free space in active heading block in words (active space)  
 S(D) – size of the initial data area in the active head expressed in word  
 S(B) – size of the block expressed in words  
 SEP – size of the min. separator between reference and data area in words  
 N – number of variables registered in the eel\_descriptor.  
 wsize - size of the given variable expressed in words (see eel\_descriptor).  
 TH - refresh threshold defined in eel\_descriptor.h

Where:

$S(B) = 256$ ,  $S(H) = 8$ ,  $SEP = 3$ ,  $S(R) = 2*N + SEP$

$$S(D) = \sum_{i=1}^N wsize(data_i)$$

After initial programming following situation in EEL pool is assumed:

- 1) the active region of the EEL-pool contains only one instance (the initial one) of each variable registered in EEL descriptor.
- 2) the remaining EEL (none-excluded and data-less) blocks are prepared.

In such situation the remaining active space S(F) in the active heading block and the number of prepared blocks S(P) could be one criteria for proper configuration of the refresh threshold.

$$S(F) = S(B) - S(H) - S(R) - S(D)$$

**CAUTION:**

**Before releasing the EEL configuration have to be ensured by tests under worst case conditions (write frequency, write duration, block exclusion and so on) required by the application.**

The following practical examples of EEL pool configuration should illustrate the dependencies.

Figure 4-2 Configuration for small data amount where S(F) is sufficient

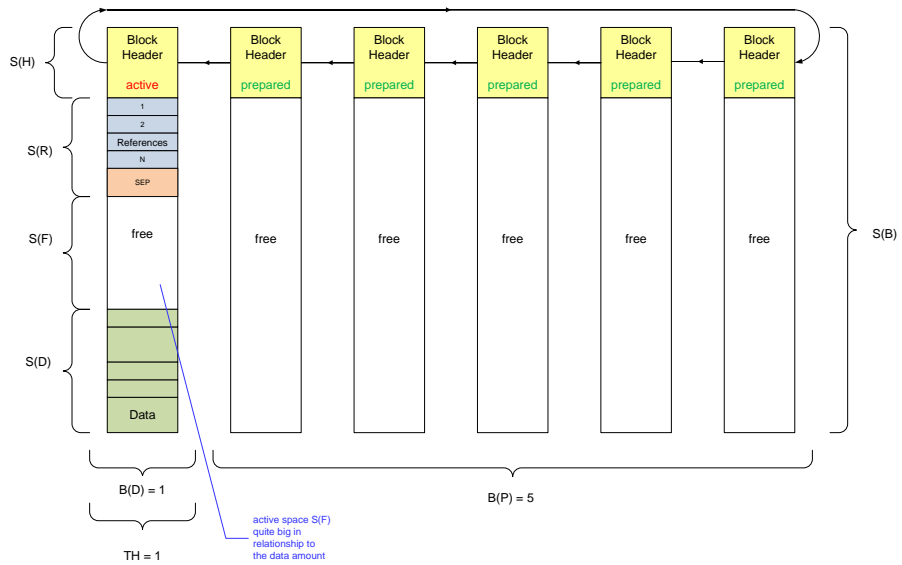

In the above scenario the active space S(F) is quite big, so that many instances of relatively small variables can be written into it before activation of the next block becomes necessary. When setting TH=1 the B(P) will be maximized automatically by the background process (EEL\_Handler(t)). The relatively big buffer of prepared blocks allows intensive, continuous writing process for a long time before “space expansion” will be enforced by a pool-full situation.

Figure 4-3 Configuration for larger data amount where S(F) is sufficient

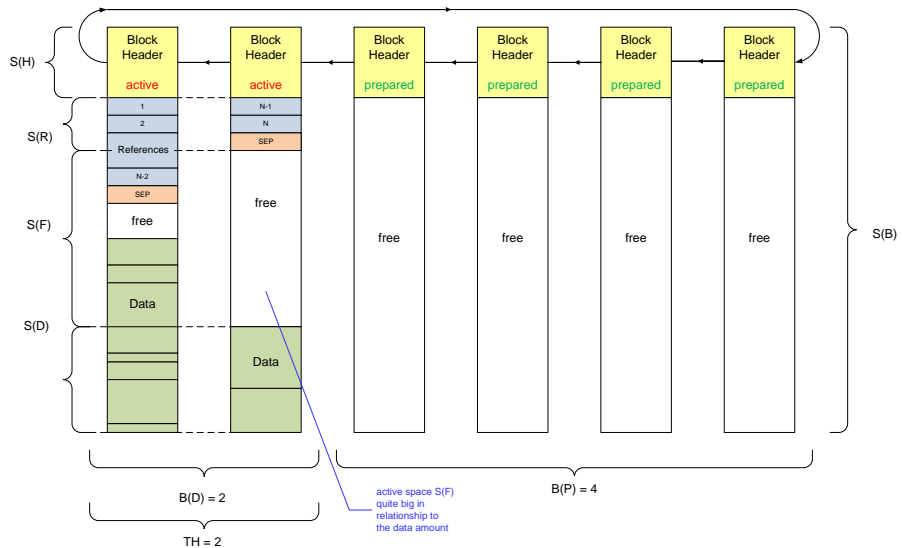

This example is similar to the previous one, but the total amount of initial data exceeds the space in one block. The active space is big enough, consequently the refresh threshold TH can be set to 2 to keep B(P) at maximal possible level.

Figure 4-4 Configuration for larger data amount where S(F) is not sufficient

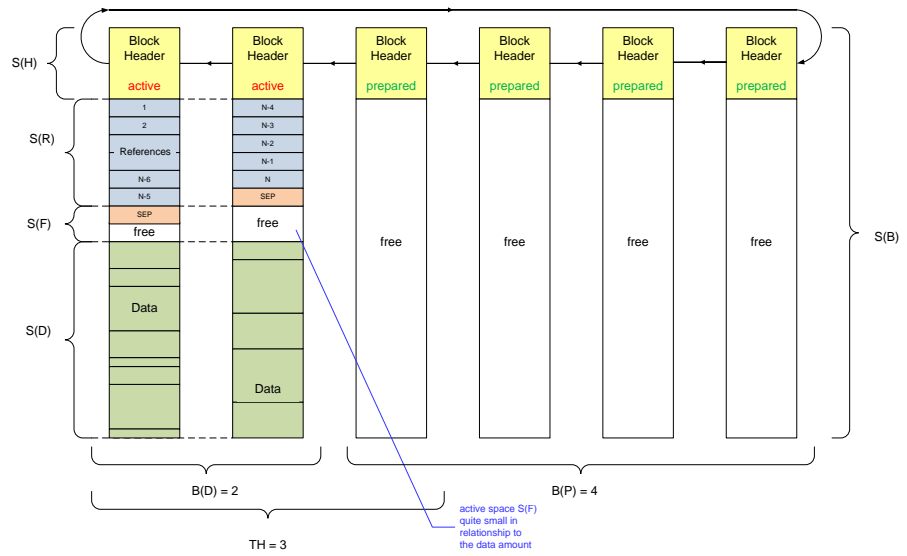

In that example like in the previous one, the initial data occupies 2 blocks ( $B(D)=2$ ), but in that case the remaining space  $S(F)$  in the active head is very small. To avoid that each write access would immediately cause a refresh and afterwards an erase cycle, the refresh threshold  $TH$  must be set to  $TH = B(D) + 1 = 3$  in that case.

## 4.5 Initialization

After power-on RESET the EEL has to be initialized by using the `EEL_Init` function. After this the plausibility of the configuration is checked and all internal variables are initialized. The driver remains passive and access to the flash medium is disabled.

```
my_eel_status_u08 = EEL_Init();

if (my_eel_status_u08 == EEL_OK)
{
    /* EEL is initialized */
}
else My_ErrorHandler();
```

## 4.6 EEL activation and deactivation

After power-ON reset the Data Flash hardware is passive. Before using the EEL commands the access to the Data Flash has to be opened and the clock of the Data Flash hardware has to be switched on.

The physical resource data-flash is divided in the FAL into two virtual parts: the EEL-pool and the USER-pool. Both of them can be opened and closed independently. To open access to the EEL-pool the `EEL_Open()` function has to be called. To avoid unexpected side-effects the FAL is managing the Data Flash clock status (ON/OFF) internally.

The sequencer clock:

- is OFF after `FAL_Init(...)`
- goes ON when any part of the FAL-pool is being opened.
- remains ON when any part of the FAL-pool is still open
- goes OFF when both parts of the FAL-pool were closed.

The EEL-pool can be opened and closed by using the interface function `EEL_Open()/EEL_Close()`.

```

.....
<POWER-ON RESET>                /* sequencer clock is OFF */
.....
my_fal_status = FAL_Init(&my_fal_descriptor);
if (my_fal_status <> FAL_OK) My_ErrorHandler();
.....
.....
my_eel_status = EEL_Init();
if (my_eel_status <> EEL_OK) My_ErrorHandler();
.....
.....
EEL_Open(); /* data flash clock starts here controlled */
.....
.....
EEL-commands can be executed here
.....
.....
FAL_Open();          /* data flash clock remains ON here */
.....
.....
FAL commands can be used for access to the USER-pool
.....
.....
EEL_Close();        /* data flash clock remains ON because */
.....                /* FAL is still accessing the USER-pool */
.....
EEL-commands cannot be executed anymore
FAL-commands can be used for access to the USER-pool

.....
.....
FAL_Close();        /* data flash clock is switched OFF here */
.....
.....

```

## 4.7 Foreground and background process

The background process is not visible directly to the user. It should take care for keeping conditions defined by the user in the configuration. Especially minimation of the invalid region and maximation of the space (according to the predefined refresh threshold).

### 4.7.1 Controlling background process

When automatical maintenance is required, the EEL\_Handler(t) has to be called periodically in any loop (for example in the idle-loop or in the scheduler-loop).

When the application want to know if background maintenance is surely finished the operation status provided by EEL\_GetDriverStatus(...) must be stable EEL\_OPERATION\_IDLE for at least 4 EEL\_Handler(0) calls.

In other words, min. 4 internal states of the EEL must be executed in EEL\_OPERATION\_IDLE operation-status to be sure that the background maintenance is definitively finished.

Figure 4-5 Example flow to ensure background passivity (enforced mode only)

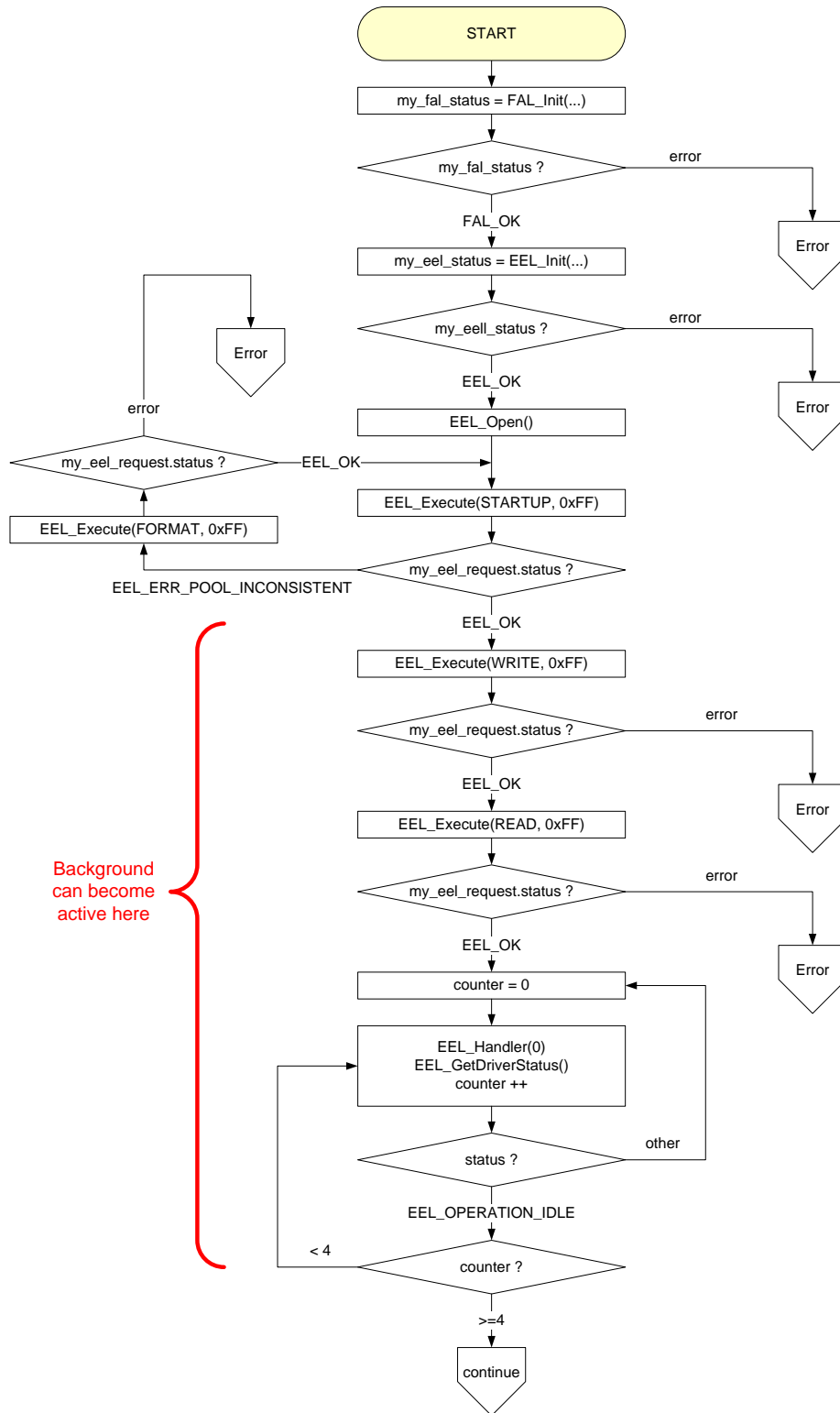
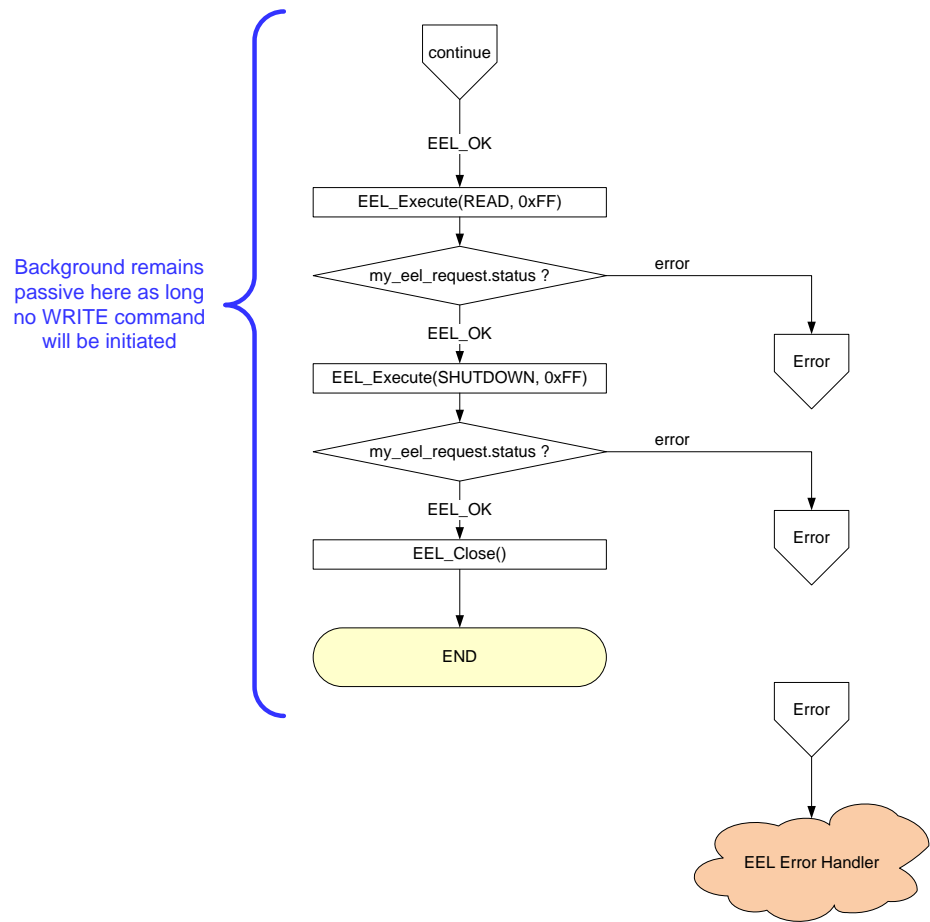

Figure 4-6 Example flow to ensure background passivity (cont.)



## 4.8 Commands

EEL commands has to be initiated by passing completed EEL-request using the function `EEL_Execute(&my_eel_request)`. To simplify the handling of the EEL the command spectrum was reduced to the essential only. Depending on the affected object there are two groups of commands supported by the EEL. Some of them influences the operation and status of the whole EEL-pool and some other the instance data only.

All EEL commands are executed/handled in the same wise and can be executed in individual execution mode.

Figure 4-7 General command execution flow

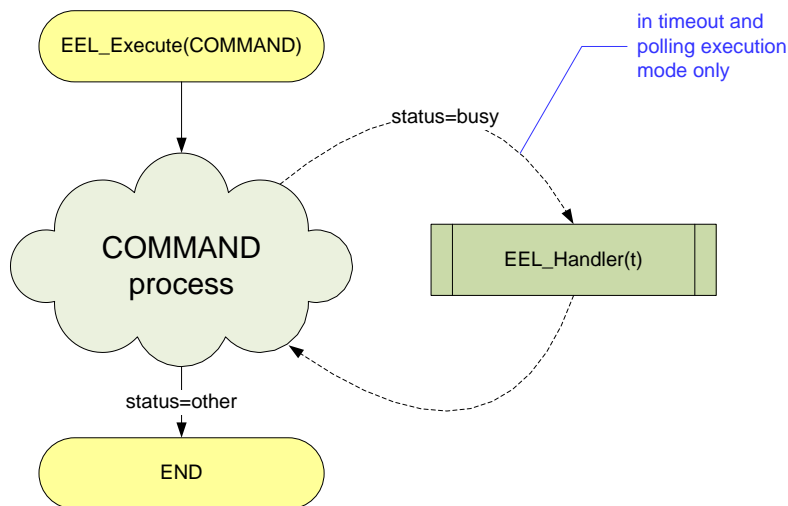

### 4.8.1 Pool oriented commands

EEL pool oriented command influences the blocks or data in the whole EEL pool.

#### 4.8.1.1 Command STARTUP

The startup command interprets the actual status of the EEL-pool, especially the region parameters, block status flags and instance references. Successful STARTUP command opens the access to the EEL data for the variable oriented commands.



Table 4-5 Status of EEL\_CMD\_STARTUP command

Status	Class	Background and Handling	
EEL_ERR_INITIALIZATION	heavy	meaning	EEL not initialized or not opened
		reason	wrong handling on user side
		remedy	Initialize and open EEL before using it
EEL_ERR_COMMAND	light	meaning	invalid command code
		reason	unknown code used in request
		remedy	use eel_command_t type only
EEL_ERR_POOL_INCONSISTENT	heavy	meaning	pool structure not usable
		reason	inconsistent EEL pool detected *)
		remedy	FORMAT the EEL pool
EEL_ERR_POOL_EXHAUSTED	fatal	meaning	EEL pool size smaller < 3 blocks
		reason	to much blocks excluded
		remedy	no remedy, EEL dead
EEL_ERR_REJECTED	normal	meaning	EEL cannot accept the request
		reason	EEL busy with any other request
		remedy	wait until status changes or call EEL_Handler() until request accepted.
EEL_BUSY	normal	meaning	request is being processed
		reason	request checked and accepted
		remedy	wait until status changes call EEL_Handler() until request accepted.
EEL_OK	normal	meaning	request was finished regular
		reason	no problems during command execution
		remedy	nothing

**Supported execution modes:**

enforcing, timeout, polling

Note 1):

EEL pool inconsistency can be caused by various reasons, for example:

- FIP flag is <> 0xFFFFFFFF
- RWP or DWP not found
- no active region detected or active-head missing
- active region not homogenous (discontinued by invalid block)
- all blocks excluded

**Code example (enforced mode):**

```

/* declaration of the request variable */
eel_request_t my_eel_request;
.....
.....
.....
/* specification of a time limited STARTUP request */
my_eel_request.command_enu = EEL_CMD_STARTUP;
my_eel_request.timeout_u08 = 255;
EEL_Execute(&my_eel_request);

if (my_eel_request.status_enu != EEL_OK) My_Error_Handler();

.....
.....
.....

```

**Code example (timeout mode):**

```

/* declaration of the request variable */
eel_request_t my_eel_request;
.....
.....
.....
/* specification of a time limited STARTUP request */
my_eel_request.command_enu = EEL_CMD_STARTUP;
my_eel_request.timeout_u08 = 20;
EEL_Execute(&my_eel_request);
.....
.....
.....

/* execute a state as long not finished */
do{
    EEL_Handler(20);
} while (my_eel_request.status_enu == EEL_BUSY)

if (my_eel_request.status_enu != EEL_OK) My_Error_Handler();

.....
.....
.....

/* periodical counting timeout tick */
void isr_tm01(void)
{
    EEL_TimeOut_CountDown();
}

```

**Code example (polling mode):**

```
/* declaration of the request variable */
eel_request_t my_eel_request;

.....

/* specification of a time limited STARTUP request */
my_eel_request.command_enu = EEL_CMD_STARTUP;
my_eel_request.timeout_u08 = 0;
EEL_Execute(&my_eel_request);

.....

/* execute a state as long not finished */
do{
    EEL_Handler(0);
} while (my_eel_request.status_enu == EEL_BUSY)

if (my_eel_request.status_enu != EEL_OK) My_Error_Handler();

.....
```

## 4.8.1.2 Command SHUTDOWN

There is no real functionality behind the SHUTDOWN command. It is just used for synchronization between the background processes and the application. Practically it is just waiting until all running background processes (REFRESH, EXPANSION,...) are finished correctly. The access to the EEL pool is closed and the access status provided by EEL\_GetDriverStatus(&my\_driver\_status) is EEL\_ERR\_ACCESS\_LOCKED. Also the EEL\_Handler(t) becomes passive and does not consume CPU time anymore (just few clocks).

Table 4-6 Status of EEL\_CMD\_SHUTDOWN command

Status	Class	Background and Handling	
EEL_ERR_INITIALIZATION	heavy	meaning	EEL not initialized
		reason	wrong handling on user side
		remedy	Initialize EEL before using it
EEL_ERR_COMMAND	light	meaning	invalid command code
		reason	unknown code used in request
		remedy	use eel_command_t type only
EEL_ERR_INTERNAL	heavy	meaning	unexpected/unknown error code generated in background
		reason	SW bug, EMI, unexpected problems
		remedy	no standard remedy possible. Next STARTUP should manage the problem
EEL_ERR_REJECTED	normal	meaning	EEL cannot accept the request
		reason	EEL busy with other request
		remedy	Call EEL_Handler() and retry later
EEL_BUSY	normal	meaning	request is being processed
		reason	request checked and accepted
		remedy	Call EEL_Handler() until status have changed.
EEL_OK	normal	meaning	request was finished regular
		reason	no problems did happen during command execution
		remedy	nothing

**Supported execution modes:**  
enforcing, timeout, polling

**Code example (enforced mode):**

```

/* declaration of the request variable */
eel_request_t my_eel_request;
.....
.....
/* specification of a time limited SHUTDOWN request */
my_eel_request.command_enu = EEL_CMD_SHUTDOWN;
my_eel_request.timeout_u08 = 255;
EEL_Execute(&my_eel_request);

if (my_eel_request.status_enu != EEL_OK) My_Error_Handler();
.....
.....

```

**Code example (timeout mode):**

```

/* declaration of the request variable */
eel_request_t my_eel_request;
.....
.....
/* specification of a time limited SHUTDOWN request */
my_eel_request.command_enu = EEL_CMD_SHUTDOWN;
my_eel_request.timeout_u08 = 20;
EEL_Execute(&my_eel_request);
.....
.....
/* execute a state as long not finished */
do{
    EEL_Handler(20);
} while (my_eel_request.status_enu == EEL_BUSY)

if (my_eel_request.status_enu != EEL_OK) My_Error_Handler();
.....
.....
.....
/* periodical timeout count tick */
void isr_tm01(void)
{
    EEL_TimeOut_CountDown();
}

```

**Code example (polling mode):**

```

/* declaration of the request variable */
eel_request_t my_eel_request;
.....
.....
/* specification of a time limited SHUTDOWN request */
my_eel_request.command_enu = EEL_CMD_SHUTDOWN;
my_eel_request.timeout_u08 = 0;
EEL_Execute(&my_eel_request);
.....
.....
/* execute a state as long not finished */
do{
    EEL_Handler(0);
} while (my_eel_request.status_enu == EEL_BUSY)

if (my_eel_request.status_enu != EEL_OK) My_Error_Handler();
.....
.....

```

## 4.8.1.3 Command FORMAT

The format command destroys all data and creates an “empty” EEL pool consists of one active block. All remaining “not excluded” blocks are “prepared” by this command. After format the STARTUP command must be executed after FORMAT to identify the new EEL-pool status.

Table 4-7 Status of EEL\_CMD\_FORMAT command

Status	Class	Background and Handling	
EEL_ERR_INITIALIZATION	heavy	meaning	EEL not initialized
		reason	wrong handling on user side
		remedy	Initialize EEL before using it
EEL_ERR_COMMAND	light	meaning	invalid command code
		reason	unknown code used in request
		remedy	use eel_command_t type only
EEL_ERR_POOL_EXHAUSTED	fatal	meaning	EEL pool size smaller < 3 blocks
		reason	to much blocks excluded
		remedy	no remedy, EEL dead
EEL_ERR_INTERNAL	heavy	meaning	unexpected/unknown error code generated in background
		reason	SW bug, EMI, unexpected problems
		remedy	No standard remedy possible, analyze background status for details.
EEL_ERR_REJECTED	normal	meaning	EEL cannot accept the request
		reason	EEL busy with other request
		remedy	Call EEL_Handler or retry later
EEL_BUSY	normal	meaning	request is being processed
		reason	request checked and accepted
		remedy	Call EEL_Handler
EEL_OK	normal	meaning	request was finished regular
		reason	no problems during command execution happens
		remedy	nothing

**Supported execution modes:**  
enforcing, timeout, polling

**CAUTION:**

Once started, the **FORMAT** command must be completed successfully. When **RESET** discontinues a running **FORMAT**, the following **STARTUP** command will fail with status **EEL\_ERR\_POOL\_INCONSISTENT**. This should enforce the user to re-start the broken **FORMAT** just to create a consistent and empty EEL-pool in any case.

**Code example (enforced mode):**

```

/* declaration of the request variable */
eel_request_t my_eel_request;
.....
.....
.....
/* specification of a time limited FORMAT request */
my_eel_request.command_enu = EEL_CMD_FORMAT;
my_eel_request.timeout_u08 = 0xFF;
EEL_Execute(&my_eel_request);

if (my_eel_request.status_enu != EEL_OK) My_Error_Handler();

.....
.....
.....

```

**Code example (timeout mode):**

```

/* declaration of the request variable */
eel_request_t my_eel_request;
.....
.....
.....
/* specification of a time limited FORMAT request */
my_eel_request.command_enu = EEL_CMD_FORMAT;
my_eel_request.timeout_u08 = 20;
EEL_Execute(&my_eel_request);
.....
.....
.....

/* execute a state as long not finished */
do{
    EEL_Handler(20);
} while (my_eel_request.status_enu == EEL_BUSY)

if (my_eel_request.status_enu != EEL_OK) My_Error_Handler();

.....
.....
.....

/* periodical timeout count tick */
void isr_tm01(void)
{
    EEL_TimeOut_CountDown();
}

```

**Code example (polling mode):**

```

/* declaration of the request variable */
eel_request_t my_eel_request;
.....
.....
/* specification of a time limited FORMAT request */
my_eel_request.command_enu = EEL_CMD_FORMAT;
my_eel_request.timeout_u08 = 0;
EEL_Execute(&my_eel_request);
.....
.....

/* execute a state as long command not finished */
do{
    EEL_Handler(0);
    CheckCommunicationInterface();
    DoSomethingElse();
} while (my_eel_request.status_enu == EEL_BUSY)

if (my_eel_request.status_enu != EEL_OK) My_Error_Handler();

.....
.....

```

**Figure 4-8 EEL pool after FORMAT (pool complete)**



Figure 4-9 EEL pool after FORMAT (1 block excluded)

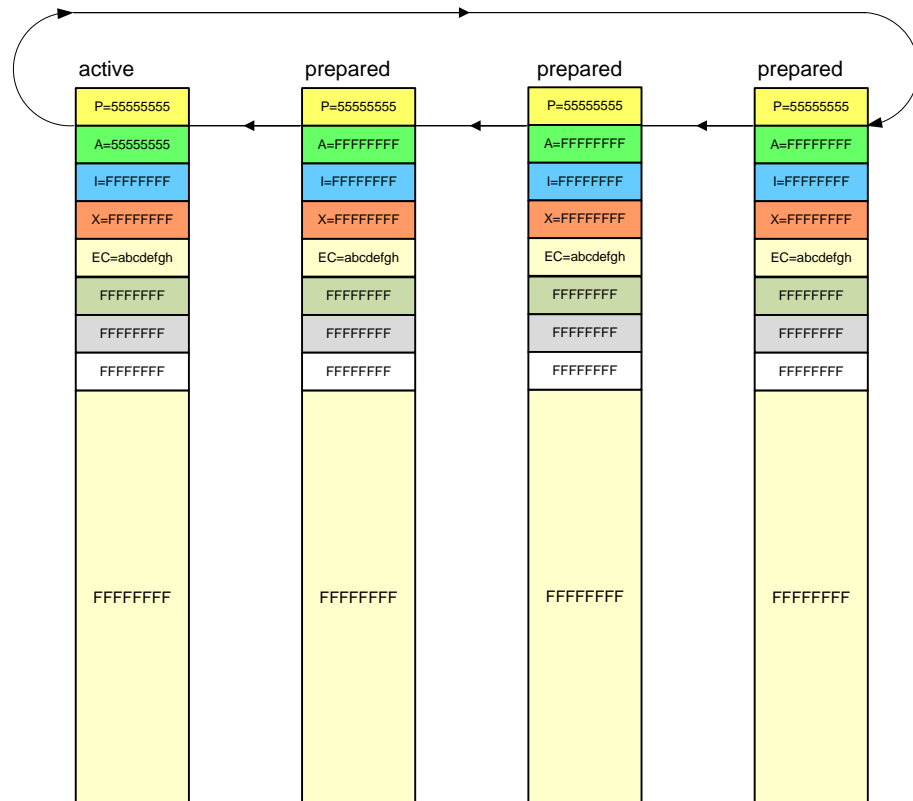
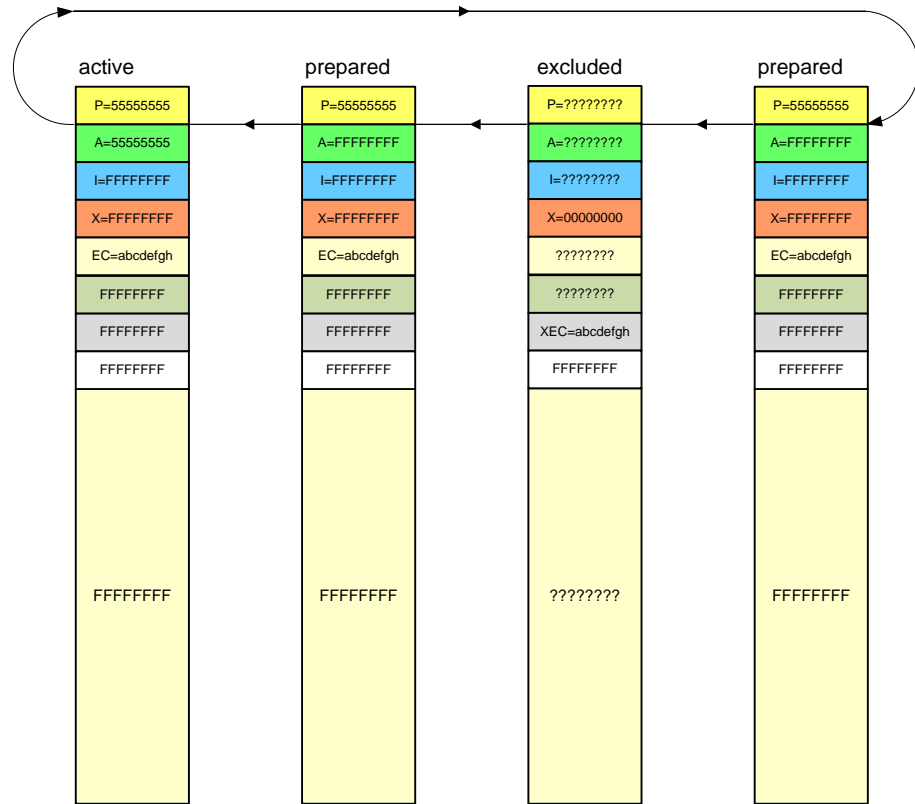

Note:

If the third block was already excluded before starting formatting its status remains untouched by the FORMAT command.

## 4.8.1.4 Command CLEANUP

The cleanup command compresses the active region occupied by data to minimum. The “prepared” region is maximized. Data are not lost in that case. STARTUP is not necessary after CLEANUP for further operation.

Table 4-8 Status of EEL\_CMD\_CLEANUP command

Status	Class	Background and Handling	
EEL_ERR_INITIALIZATION	heavy	meaning	EEL not initialized
		reason	wrong handling on user side
		remedy	Initialize EEL before using it
EEL_ERR_COMMAND	light	meaning	invalid command code
		reason	unknown code used in request
		remedy	use eel_command_t type only
EEL_ERR_ACCESS_LOCKED	light	meaning	no access to EEL pool
		reason	STARTUP missing
		remedy	Execute STARTUP
EEL_ERR_POOL_EXHAUSTED	fatal	meaning	EEL pool size smaller < 3 blocks
		reason	to much blocks excluded
		remedy	no remedy, EEL dead
EEL_ERR_INTERNAL	heavy	meaning	unexpected/unknown error code generated in background
		reason	SW bug, EMI, unexpected problems
		remedy	Execute STARTUP. Background status can be analyzed for details.
EEL_ERR_REJECTED	normal	meaning	EEL cannot accept the request
		reason	EEL busy with other request
		remedy	Call EEL_Handler or retry later
EEL_BUSY	normal	meaning	request is being processed
		reason	request checked and accepted
		remedy	Call EEL_Handler
EEL_OK	normal	meaning	request was finished regular
		reason	no problems during command execution happens
		remedy	nothing

**Supported execution modes:**

enforcing, timeout, polling

**Code example (enforced mode):**

```

/* declaration of the request variable */
eel_request_t my_eel_request;
.....
.....
/* specification of a time limited CLEANUP request */
my_eel_request.command_enu = EEL_CMD_CLEANUP;
my_eel_request.timeout_u08 = 255;
EEL_Execute(&my_eel_request);

if (my_eel_request.status_enu != EEL_OK) My_Error_Handler();
.....
.....

```

**Code example (timeout mode):**

```

/* declaration of the request variable */
eel_request_t my_eel_request;
.....
.....
.....
/* specification of a time limited CLEANUP request */
my_eel_request.command_enu = EEL_CMD_CLEANUP;
my_eel_request.timeout_u08 = 20;
EEL_Execute(&my_eel_request);
.....
.....
.....

/* execute a state as long not finished */
do{
    EEL_Handler(20);
} while (my_eel_request.status_enu == EEL_BUSY)

if (my_eel_request.status_enu != EEL_OK) My_Error_Handler();

.....
.....
.....

/* periodical timeout count tick */
void isr_tm01(void)
{
    EEL_TimeOut_CountDown();
}

```

**Code example (polling mode):**

```

/* declaration of the request variable */
eel_request_t my_eel_request;
.....
.....
.....
/* specification of a time limited CLEANUP request */
my_eel_request.command_enu = EEL_CMD_CLEANUP;
my_eel_request.timeout_u08 = 0;
EEL_Execute(&my_eel_request);
.....
.....
.....

/* execute a state as long not finished */
do{
    EEL_Handler(0);
} while (my_eel_request.status_enu == EEL_BUSY)

if (my_eel_request.status_enu != EEL_OK) My_Error_Handler();

.....
.....
.....
    
```

**Figure 4-10 EEL pool before CLEANUP command (example)**

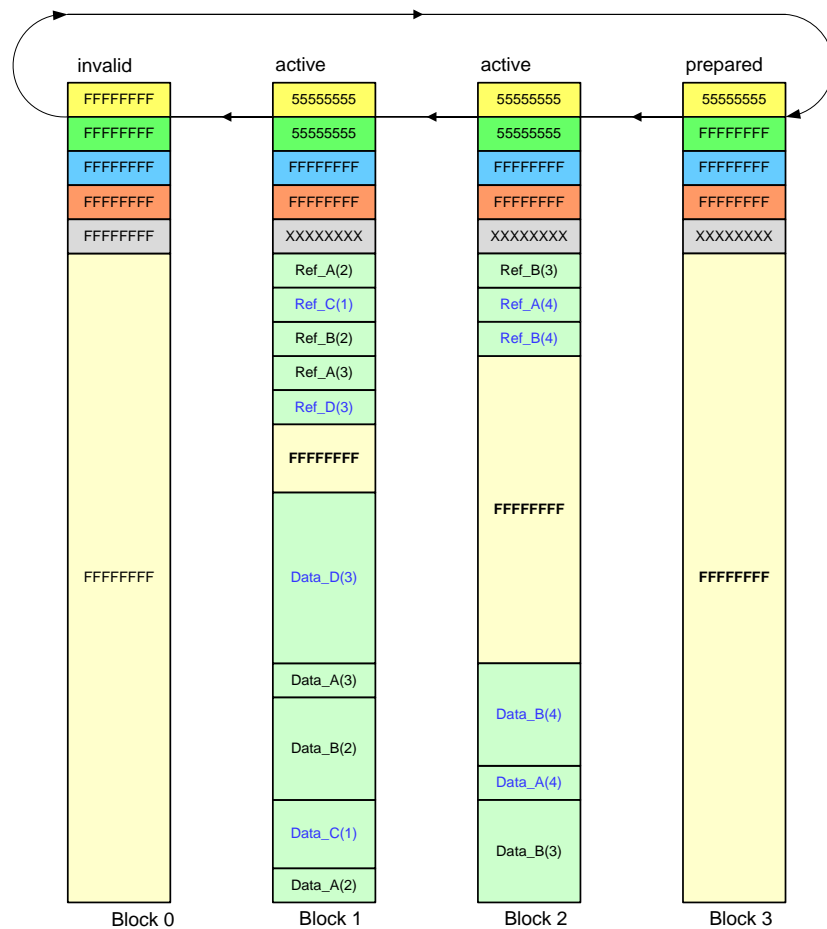
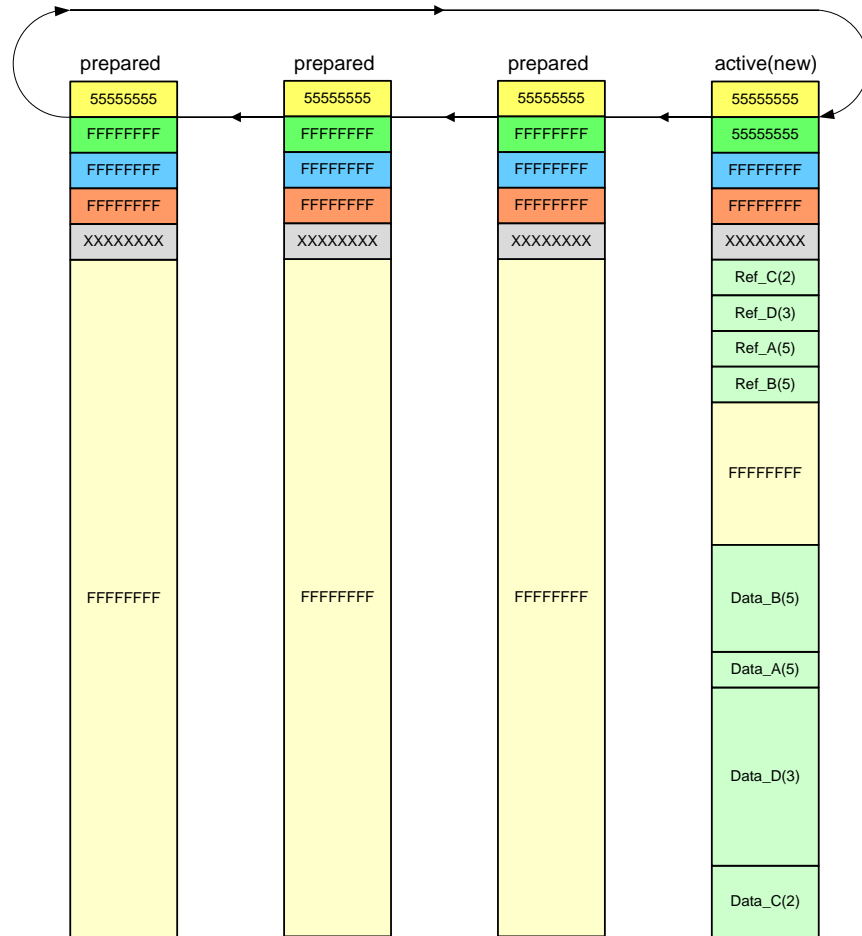

Figure 4-11 EEL pool after CLEANUP command (example)



Note:

Header word marked as XXXXXXXX contain EC, RWPprev, XEC...

#### 4.8.2 Variable oriented commands

EEL variable oriented command can be used by the application to read/write new instances (values) of the variables registered in the EEL-descriptor.

##### 4.8.2.1 Command WRITE

The write command writes new value of the EEL-variable specified by the identifier.

Table 4-9 Status of EEL\_CMD\_WRITE command

Status	Class	Background and Handling	
		meaning	
EEL_ERR_INITIALIZATION	heavy	meaning	EEL not initialized
		reason	wrong handling on user side
		remedy	Initialize EEL before using it
EEL_ERR_ACCESS_LOCKED	light	meaning	no access to EEL pool
		reason	STARTUP missing
		remedy	Execute STARTUP
EEL_ERR_PARAMETER	heavy	meaning	Unknown variable identifier
		reason	Not registered variable ID used
		remedy	Correct or register the variable in the EEL descriptor
EEL_ERR_POOL_EXHAUSTED	fatal	meaning	EEL pool size smaller < 3 blocks
		reason	to much blocks excluded
		remedy	no remedy, EEL dead
EEL_ERR_POOL_FULL	heavy	meaning	no space in pool
		reason	Due to block exclusion not enough space is to cover all variables
		remedy	Execute CLEANUP
EEL_ERR_REJECTED	normal	meaning	EEL cannot accept the request
		reason	EEL busy with other request
		remedy	Call EEL_Handler or retry later
EEL_BUSY	normal	meaning	request is being processed
		reason	request checked and accepted
		remedy	Call EEL_Handler
EEL_OK	normal	meaning	request was finished regular
		reason	no problems during command execution happens
		remedy	none

**Supported execution modes:**  
enforcing, timeout, polling

**Code example (enforced mode):**

```

/* declaration of the request variable */
eel_request_t my_eel_request;
.....
.....
.....
/* specification of a time limited WRITE request */
my_eel_request.address_pu08 = (eel_u08*)&my_A_mirror;
my_eel_request.identifier_u08 = 'A';
my_eel_request.command_enu = EEL_CMD_WRITE;
my_eel_request.timeout_u08 = 255;
EEL_Execute(&my_eel_request);

if (my_eel_request.status_enu != EEL_OK) My_Error_Handler();

.....
.....
.....

```

**Code example (timeout mode):**

```

/* declaration of the request variable */
eel_request_t my_eel_request;
.....
.....
.....
/* specification of a time limited WRITE request */
my_eel_request.address_pu08 = (eel_u08*)&my_A_mirror;
my_eel_request.identifier_u08 = 'A';
my_eel_request.command_enu = EEL_CMD_WRITE;
my_eel_request.timeout_u08 = 20;
EEL_Execute(&my_eel_request);
.....
.....
.....

/* execute a state as long not finished */
do{
    EEL_Handler(20);
} while (my_eel_request.status_enu == EEL_BUSY)

if (my_eel_request.status_enu != EEL_OK) My_Error_Handler();

.....
.....
.....

/* periodical timeout count tick */
void isr_tm01(void)
{
    EEL_TimeOut_CountDown();
}

```

**Code example (polling mode):**

```

/* declaration of the request variable */
eel_request_t my_eel_request;
.....
.....
.....
/* specification of a time limited WRITE request */
my_eel_request.address_pu08 = (eel_u08*)&my_A_mirror;
my_eel_request.identifier_u08 = 'A';
my_eel_request.command_enu = EEL_CMD_WRITE;
my_eel_request.timeout_u08 = 0;
EEL_Execute(&my_eel_request);
.....
.....
.....

/* execute a state as long not finished */
do {
    EEL_Handler(0);
} while (my_eel_request.status_enu == EEL_BUSY)

if (my_eel_request.status_enu != EEL_OK) My_Error_Handler();

.....
.....
.....

```

**Note:**

Whenever the application writes data into the EEL-pool the space available in active head may not be sufficient to cover the reference and data of the new instance. To guaranty proper operation in any situation the EEL takes care for sufficient space conditions before writing the instance. This may cause different execution time for writing same portion of data. The user can avoid that situation by offering enough CPU time for the background process that can prepare space in advance.

Depending on space precondition in different behavior is possible when writing new instance into the EEL pool. Please have a look to the below examples.



**Example 1:**

Best case conditions.

**Conditions:**

- a) Enough space available in heading active block to cover the complete instance (reference and data)
- b) EEL\_REFRESH\_BLOCK\_THRESHOLD > 1

**Sequence:**

- 1) DRP\_A(6) is written into flash word addressed by RWP  
(allocates space for the new instance in reference- and data-area)
- 2) Data\_A(6) are written word by word into the allocated space in data area.
- 3) DCS\_A(6) is written into the flash word addressed by (RWP+1)
- 4) RWP, DWP, RAM-reference, and region parameter are updated

Figure 4-12 EEL pool after WRITE command (normal example).

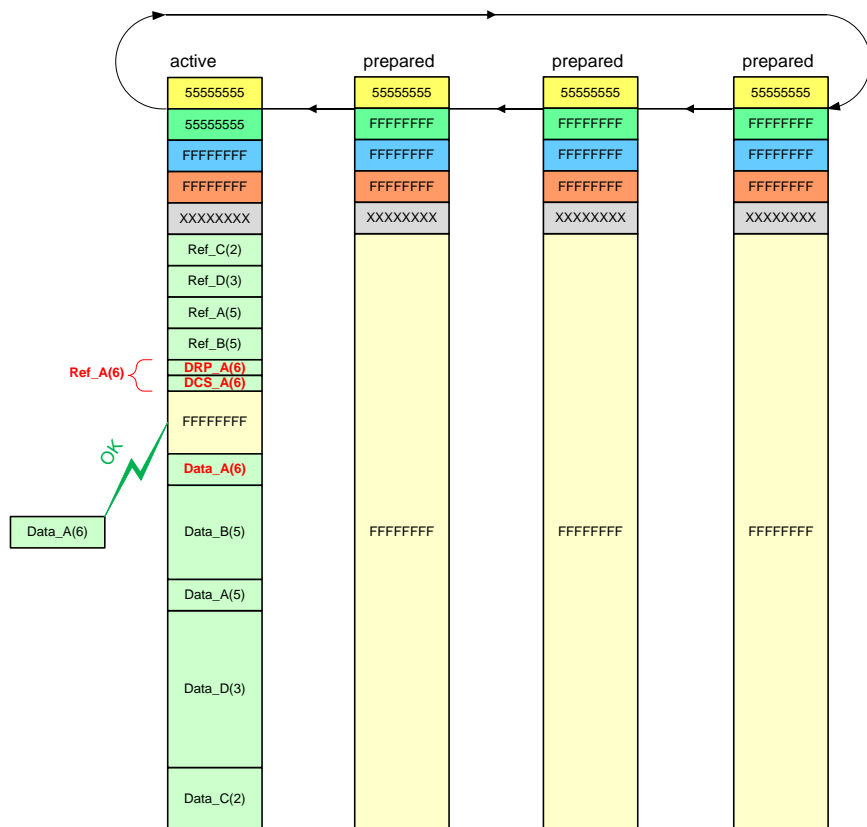

**Note:**

Data\_A(6) means 6'ts instance of the variable "A"

**Example 2:**

Best case conditions.

**Conditions:**

- a) Not enough space available in heading active block to cover the complete instance (reference and data).
- b) more than two blocks are prepared and ready for activation
- c) EEL\_REFRESH\_BLOCK\_THRESHOLD > 2

**Sequence:**

- 1) After negative space check next block will be activated before write
- 2) DRP\_D(4) is written into flash word addressed by RWP  
(allocates space for the new instance in reference- and data-area)
- 3) Data\_D(4) are written word by word into the allocated space in data area.
- 4) DCS\_D(4) is written into the flash word addressed by (RWP+1)
- 5) RWP, DWP, RAM-reference, and region parameter are updated

Figure 4-13 EEL pool after WRITE command (activation example)

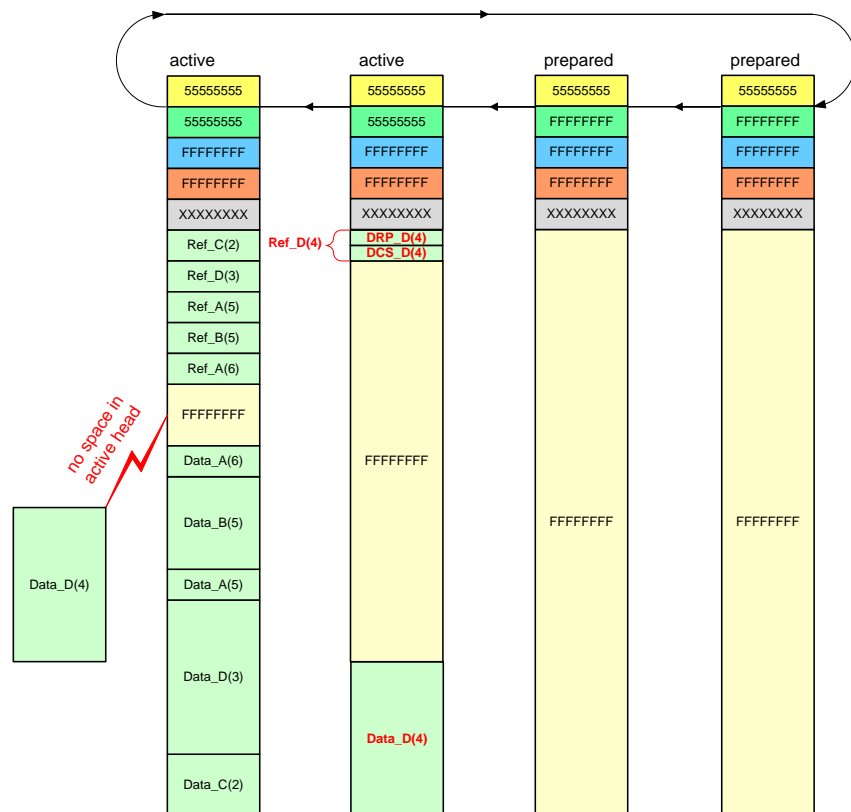

**Example 3:**

Best case conditions.

**Conditions:**

- a) Not enough space available in heading active block to cover the complete instance (reference and data).
- b) Not enough prepared for activation
- c) EEL\_REFRESH\_BLOCK\_THRESHOLD > 2

**Sequence:**

- 1) After negative space check next block should be activated before write
- 2) Activation not possible (prepared region to small)
- 3) Execution focus swapped to background for space expansion
- 4) The background refreshes the last active block C(2) -> C(3)
- 5) After refresh completion of block 0 will be invalidated and prepared
- 6) Completed space expansion swaps the execution focus back to foreground
- 7) DRP\_D(5) is written into flash word addressed by RWP  
(allocates space for the new instance in reference- and data-area)
- 8) Data\_D(5) are written word by word into the allocated space in data-area.
- 9) DCS\_D(5) is written into the flash word addressed by (RWP+1)
- 10) RWP, DWP, RAM-reference, and region parameter are updated

Figure 4-14 EEL pool before WRITE command (expansion example)

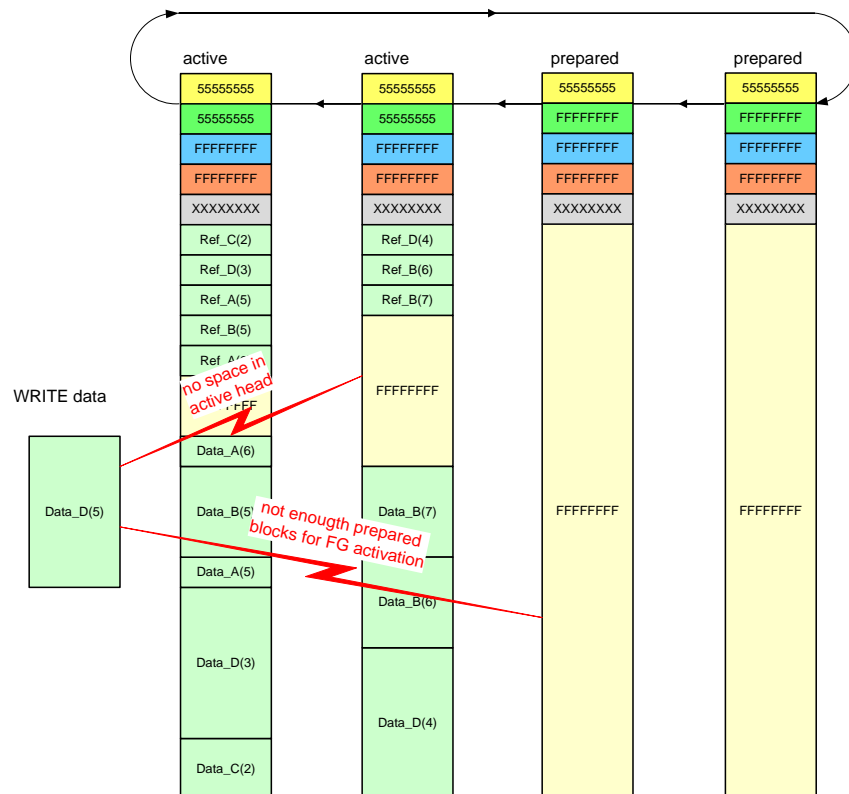
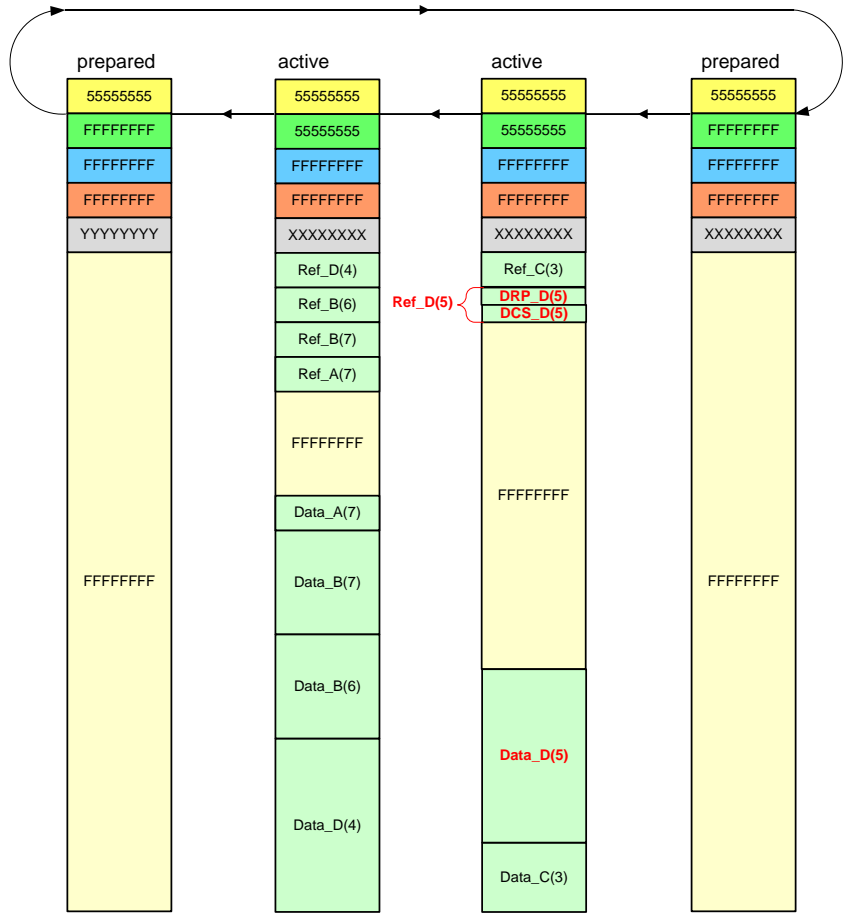

Figure 4-15 EEL pool after WRITE command (expansion example)



The final scenario after completion WRITE(D) is:

- block 0 is prepared after refreshing instance C(2) -> C(3)
- the newest (5'th) instance of D is written into block 2

## 4.8.2.2 Command READ

The read command copies the actual value of the EEL-variable specified by the identifier into its RAM mirror variable.

When checksum error (DCS) is detected internally during READ execution, the EEL will enforce re-filling the reference table and before reading the next older instance of the specified variable automatically. When no older instance exists, the READ command signalizes EEL\_ERR\_NO\_INSTANCE.

Table 4-10 Status of EEL\_CMD\_READ command

Status	Class	Background and Handling	
EEL_ERR_INITIALIZATION	heavy	meaning	EEL not initialized
		reason	wrong handling on user side
		remedy	Initialize EEL before using it
EEL_ERR_ACCESS_LOCKED	light	meaning	no access to EEL pool
		reason	STARTUP missing
		remedy	Execute STARTUP
EEL_ERR_PARAMETER	heavy	meaning	Unknown variable identifier
		reason	Not registered variable ID used
		remedy	Correct or register the variable in the EEL descriptor
EEL_ERR_NO_INSTANCE	light	meaning	no instance of the identifier found
		reason	no initial value written
		remedy	write initial value of the variable
EEL_ERR_REJECTED	normal	meaning	EEL cannot accept the request
		reason	EEL busy with other request
		remedy	Call EEL_Handler or retry later
EEL_BUSY	normal	meaning	request is being processed
		reason	request checked and accepted
		remedy	Call EEL_Handler
EEL_OK	normal	meaning	request was finished regular
		reason	no problems during command execution happens
		remedy	none

**Supported execution modes:**  
enforcing, timeout, polling

**Code example (enforced mode):**

```

/* declaration of the request variable */
eel_request_t my_eel_request;
.....
.....
.....
/* specification of a time limited READ request */
my_eel_request.address_pu08 = (eel_u08*)&my_A_mirror;
my_eel_request.identifier_u08 = 'A';
my_eel_request.command_enu = EEL_CMD_READ;
my_eel_request.timeout_u08 = 255;
EEL_Execute(&my_eel_request);

if (my_eel_request.status_enu != EEL_OK) My_Error_Handler();

.....
.....
.....

```

**Code example (timeout mode):**

```

/* declaration of the request variable */
eel_request_t my_eel_request;
.....
.....
.....
/* specification of a time limited READ request */
my_eel_request.address_pu08 = (eel_u08*)&my_A_mirror;
my_eel_request.identifier_u08 = 'A';
my_eel_request.command_enu = EEL_CMD_READ;
my_eel_request.timeout_u08 = 20;
EEL_Execute(&my_eel_request);
.....
.....
.....

/* execute a state as long not finished */
do{
    EEL_Handler(20);
} while (my_eel_request.status_enu == EEL_BUSY)

if (my_eel_request.status_enu != EEL_OK) My_Error_Handler();

.....
.....
.....

/* periodical timeout count tick */
void isr_tm01(void)
{
    EEL_TimeOut_CountDown();
}

```

**Code example (polling mode):**

```
/* declaration of the request variable */
eel_request_t my_eel_request;
.....
.....
.....
/* initiation of a READ request */
my_eel_request.address_pu08 = (eel_u08*)&my_A_mirror;
my_eel_request.identifier_u08 = 'A';
my_eel_request.command_enu = EEL_CMD_READ;
my_eel_request.timeout_u08 = 0;
EEL_Execute(&my_eel_request);
.....
.....
.....

/* execute a state as long not finished */
do{
    EEL_Handler(0);
} while (my_eel_request.status_enu == EEL_BUSY)

if (my_eel_request.status_enu != EEL_OK) My_Error_Handler();

.....
.....
.....
```

## Chapter 5 Characteristics

### 5.1 Resource consumption

All values are based on the RL78 EEL T01 V1.15 and FDL T01 V1.12.

#### RAM consumption at user side:

High speed RAM: 2 bytes  
Short address RAM: 9 bytes

#### ROM consumption:

EEL code size: 6.6 kByte  
EEL constant size:  $4+(N+1)*4$ , N = number of EEL variables

#### Final stack consumption:

FDL and EEL stack: < 120 bytes

### 5.2 Timing characteristics

The timing measurements presented in the following are based on the RL78 EEL T01 V1.15 and RL78 FDL T01 V1.12.

#### 5.2.1 Reference command execution times

The reference command execution times listed in Table 5-1 have been measured for the following scenario:

- There are 4 EEL blocks defined
- No excluded block exists
- Refresh threshold = 1
- There are 8 variables defined by EEL descriptor:  
a - 2 bytes, b - 3 bytes, c - 4 bytes, d - 5 bytes, e - 6 bytes, f - 10 bytes, x - 20 bytes, z - 255 bytes
- Each variable has been successfully written at least once into EEL pool
- The system clock frequency is 20 MHz
- Timeout time parameters for request structure and handler call  
 $T = t = 4$
- Timeout count-down tick for timing mode  $dt = 256\mu s$

Furthermore, the WRITE command is measured for two preconditions:

- Without activation: There is enough space in current active block to write any variable once more without the need of a new block activation.
- With activation: There is not enough space in current active block to write any variable once more without the need of a new block activation. A foreground activation was necessary before being able to write the instance.

Please note that presented values are no specification but rather a measurement of execution times under the above mentioned conditions and should therefore only be treated as reference.



Table 5-1 Reference command execution times (example)

Command	reference command execution time [ $\mu$ s] @ $f_x = 20$ MHz			
	condition	polling	timeout	enforcing
READ(n)	a = 2 bytes	115	90	89
	b = 3 bytes	117	92	91
	c = 4 bytes	119	93	93
	d = 5 bytes	143	113	113
	e = 6 bytes	144	115	115
	f = 10 bytes	171	138	137
	x = 20 bytes	224	183	182
	z = 255 bytes	1714	1494	1452
WRITE(n) without activation	a = 2 bytes	1332	1280	1263
	b = 3 bytes	1333	1282	1264
	c = 4 bytes	1335	1283	1266
	d = 5 bytes	1764	1702	1679
	e = 6 bytes	1766	1703	1680
	f = 10 bytes	2198	2138	2095
	x = 20 bytes	3061	2976	2926
	z = 255 bytes	28468	27679	27365
WRITE(n) with activation	a = 2 bytes	2271	2177	2158
	b = 3 bytes	2273	2178	2159
	c = 4 bytes	2275	2180	2161
	d = 5 bytes	2704	2595	2581
	e = 6 bytes	2706	2597	2575
	f = 10 bytes	3137	2994	2990
	x = 20 bytes	4001	3858	3820
	z = 255 bytes	29408	28559	28267
STARTUP	4 blocks, empty pool	4251	3989	3865
	4 blocks, a...z in pool	6460	5478	5314
FORMAT	4 blocks	28283	28148	28066
CLEANUP	a...z	50063	48694	48288
SHUTDOWN	background idle already	55	34	33

## Note 1:

The command execution time depends on the situation inside the EEL pool. The number of variables, its size, the position of the instance inside the EEL-pool, as well the momentary size of the regions inside the EEL-pool can influence the execution time of a command. The user can neutralize such effects for the WRITE command in a wide range by proper configuration of the EEL pool and by offering enough CPU time to the background process (calling EEL\_Handler(t) in the idle-loop of the application).

Note 2:

When writing continuously big amount of data the “space consumption” in the foreground process (WRITE) can become faster than the “space production” in the background process (MAINTENANCE). This could cause a deviation of the WRITE-command execution time. To avoid such effects the user should reserve adequate CPU time for the background process in relationship to the required data throughput. This can be done by calling EEL\_Handler(0) multiple or by increasing the time-slice “t” in EEL\_Handler(t).

Note 3:

After block exclusion the timing characteristics of the commands may change. This effect becomes more relevant when the data amount is quite big in relationship to the EEL pool size.

## Chapter 6 Cautions

- Library code and its constants must be located completely in the same 64k flash page.
  - For CA78K0R compiler, the library takes care in the code to define these sections with UNIT64KP relocation attribute.
  - For IAR V1.xx and IAR V2.xx compiler, the user has to ensure that the linker file specifies the Flash page size equal to 64KB when defining FAL\_CODE, FAL\_CNST, EEL\_CODE and EEL\_CNST sections.
- The FDL library initialization by means of FAL\_Init must be performed before calling EEL\_Init.
- The EEL library initialization by means of EEL\_Init must be performed before the execution of EEL\_Open, EEL\_Close, EEL\_Handler, EEL\_Execute, EEL\_TimeOut\_CountDown, EEL\_GetDriverStatus and EEL\_GetSpace.
- It is not allowed to read the data flash directly (meaning without FDL) during a command execution of the FDL/EEL.
- Do not execute the STOP or HALT instruction during the execution of the FDL/EEL. Please shutdown and close both libraries properly first.
- The watchdog timer does not stop during the execution of the FDL/EEL.
- Each request variable must be located at an even address.
- Before executing any command, all members of the request variable must be initialized. If there are any unused members in the request variable, please set arbitrary values to these members. Otherwise, a RAM parity error may cause a reset of the device. For details, please refer to the document “User's Manual: Hardware” of your RL78 product.
- The EEL is not designed as a re-entrant software. For this reason each EEL function has to be finished before a next one can be called. Consequently EEL functions should not be called in interrupt service routines. If this cannot be achieved due to interrupt processing, task switching or other mechanism, the application has to take care for the synchronization and protection against re-entrancy.
- After execution of FAL\_Init, EEL\_Init or EEL\_Close function all requested/running EEL commands will be aborted and cannot be resumed. Please take care that all running EEL commands are finished before calling this functions. This can be achieved by SHUTDOWN command as illustrated in Figure 4-1.
- It is not possible to modify the Data Flash parallel to modification of the Code Flash. This means Self-programming (FSL) and EEPROM emulation cannot work at the same time.
- The internal high-speed oscillator must be started before using of the FDL/EEL.
- It is not allowed to locate any arguments and stack memory to address of 0xFFE20 and above.
- In case the Data Transfer Controller (DTC) is used in parallel to the FDL/EEL, do not locate the RAM area for DTC to address 0xFFE20 and above.
- Please check the restrictions of your target device described in the device user's manual in case of accessing the data flash via the FDL/EEL.
- Do not use the RAM area used by the FDL/EEL (including the prohibited RAM area) before both libraries have been closed. Please see also “Self RAM list of Flash Self-Programming Library for RL78 Family” (R20UT2944EJxxxx).

- In case of an accidental write to the EEL pool (e.g. due to stack runaway, misuse of FDL etc.), the following scenarios may occur:
  - In case of damaged block flags the whole eel pool could become inconsistent. As a result, all valid instances could be lost.
  - In case of damaged instance entry, the affected instance could become invalid rendering an old instance (and therefore outdated value) valid.
- It is not allowed to continue the execution of the EEL in case the FDL or EEL descriptor has been changed. In such a situation, the initialization of the FDL and EEL shall be performed as well as the EEL pool format via the FORMAT command.
- Do not operate the DFLCTL(Data Flash Control register) during the execution of the EEL.
- Additional cautions for using the EEL for IAR V2.xx.
  - Library code and constants must be located completely in the same 32KB memory range.
  - Each segment (EEL\_SDAT, EEL\_CNST(including constant eel\_descriptor),EEL\_UDAT) must be located from an even address.
  - Do not align the members of any structure (by padding between them) that is to be used in the argument of an EEL library function. Refer to the eel\_types.h file for more information about the size of each structure.
  - If you wish to use a linker configuration file included of the IAR V2.2x compiler (instead of a sample linker configuration file in the flash library package), specify flash libraries sections with special names for Renesas objects (R\_TEXTF\_UNIT64KP, R\_SBSS) in the linker configuration file.

e.g.)

```
ro section FAL_CODE -> ro code R_TEXTF_UNIT64KP section FAL_CODE
ro section EEL_CODE -> ro code R_TEXTF_UNIT64KP section EEL_CODE
rw section FAL_DATA -> rw data R_SBSS section FAL_DATA
rw section EEL_SDAT -> rw data R_SBSS section EEL_SDAT
```

Note:

Sections FAL\_CNST and EEL\_CNST do not require special names for Renesas objects since these sections are defined in the sample source files. (eel\_descriptor.c, fdl\_descriptor.c).

Simply declare these flash libraries sections in a linker configuration file as if they are normal sections.

e.g.)

```
ro section FAL_CNST
ro section EEL_CNST
```

## Revision History

Chapter	Page	Description
All		Rev. 1.00: Initial document
All		Rev. 1.01: Switching document style to 'User Manual', previous document number: R01AN0707ED0100.
4.1	59	Adding section describing how to obtain the library.
4.4.2	63	Adding section about endurance calculation.
4.4.4	64	Adding section about variable initialization.
4.4.5	66	Correcting block size S(B) =256.
5.1	97	Correcting high speed RAM consumption (2byte).
5.2	97	Adding reference command execution times
6	100	Adding general cautions.
All	All	Rev. 1.10: "Renesas version", "Renesas compiler" and "REN compiler" unified to "CA78K0R compiler"
All	All	IAR V2.xx Compiler support extended
6	99	Adding general cautions.

# EEPROM Emulation Library