

EU096 Flexible 6-Channel Power Sequencer

Software Design

Contents

1. Introduction.....	3
1.1 Overview.....	3
1.2 Main Features.....	3
1.3 Tools and Software Versions required	3
1.3.1 RL78/G12	3
1.3.2 RL78/G1C.....	3
1.3.3 Graphical User Interface	3
2. Resource Constraints and Usage	4
2.1 Memory resources.....	4
2.2 CPU Load	4
2.3 Timing constraints	4
3. Physical Structure.....	6
3.1 Structure	6
3.2 Hardware block diagram	6
4. Software Layer	8
4.1 Layering.....	8
4.2 Subsystems	9
5. Context Management	10
5.1 System Initialization.....	10
5.2 Interrupts	10
5.3 Critical Sections.....	11
5.4 Synchronization	11
6. Mechanism	12
6.1 System State Model	12
6.1.1 Main application sequence Diagram	12
6.1.2 Power On/Off Sequence Diagram.....	13
7. Peripherals Configuration	14
7.1 Fixed Function Assignments	14
7.2 Clock tree	14
7.3 On-Chip Debugging.....	15
7.4 Reset Source / Output Function	16
7.5 Port function / Pin assignments.....	16

7.5.1	Port 0 setup:	16
7.5.2	Port 1 setup:	16
7.5.3	Port 2 setup:	17
7.5.4	Port 3 setup:	17
7.5.5	Port 4 setup:	17
7.5.6	Port 5 setup:	17
7.5.7	Port 6 setup:	18
7.5.8	Port 12 setup:	18
7.5.9	Port 13 setup:	18
7.5.10	Port 14 setup:	18
7.5.11	Port Configuration Summary	19
7.6	External Interrupt	19
7.7	A / D Converter	19
7.8	Timer Array Unit	21
7.8.1	Channel 0	21
7.8.2	Channel 1	21
7.8.3	Channel 2	22
8.	Functional Design	23
8.1	Component Interfaces	23
8.1.1	Application Module Interface	23
8.1.2	UART Communication	23
9.	Software-Update	24
10.	GUI – Graphical User Interface	25
10.1	System Information	25
10.2	COM Configuration	25
10.3	Set ON Transition Time	26
10.4	Set OFF Transition Time	28
10.5	Oscilloscope	29
10.6	Power On/ Power Off	30
10.7	Data Handling	32
11.	Nomenclature	33
	References	34
	Revision History	35

1. Introduction

1.1 Overview

This document provides detailed information about the EU096 Flexible 6-Channel Power Sequencer software architecture and how the functionality was implemented. The EU096 Flexible 6-Channel Power Sequencer demonstrator board is dedicated to a whole set of FPGAs and SoC applications (e.g., due to unrestrained programmable delays, sensing of main input voltage via ADC of the microcontroller, monitoring of each single power rail via MCU-integrated ADC, reading the Power good-signals of each DC/DC Converter etc.).

The whole system is built around a Renesas RL78/G12 microcontroller. The IDE used for this software project is E2Studio for RL78 version which also include the configurator tool and a CC-RL compiler.

1.2 Main Features

The main characteristics of the EU096 Flexible 6-Channel Power Sequencer board are:

- Board Power Supply (12V default)
- 6 independent DC-DC Converters supplied by 12V input (0V85, 1V, 1V5, 1V8, 2V5 and 3V3 output voltage)
- RL78/G12 – main microcontroller
- RL78/G1C – microcontroller with integrated USB controller for USB2Serial converter
- Debug feature via E1 connector
- Individual Power Good and output voltage monitoring

1.3 Tools and Software Versions required

1.3.1 RL78/G12

For the RL78/G12 Microcontroller the following software versions are required:

- [Renesas e² studio Integrated Solution Development Environment \(ISDE\)](#) v 2020-10 or greater
- [Code Generator Plug-in for RL78](#)
- [Renesas CC-RL](#) v1.09.00 or greater

1.3.2 RL78/G1C

For RL78/G1C Microcontroller following versions are required:

- [Renesas e² studio Integrated Solution Development Environment \(ISDE\)](#) v 2020-10 or greater
- [Code Generator Plug-in for RL78](#)
- [Renesas CC-RL](#) v1.09.00 or greater

1.3.3 Graphical User Interface

For Graphical User Interface the following tools were used:

- Visual Studio Community 2019
- ZedGraph Api

2. Resource Constraints and Usage

2.1 Memory resources

The chosen microcontroller, RL78/G12 (R5F102A7), includes:

- 4KB Code Flash Memory
- 2KB Data Flash Memory
- 512 Bytes RAM • 256 Bytes + 2 KB Special Function Register (SFR)

2.2 CPU Load

There is no CPU Load constraints and power usage is not taken into consideration given that the Power Sequencer is powered by an external source at 12V.

2.3 Timing constraints

- Regarding timing constraints, it is required on the GUI to select the baud rate of 115200 in order for the communication on UART to work properly.
- The Power Sequencer updates the GUI with the voltages on outputs cyclically at every 10ms.
- The Power On sequence output can be configured from the *Set ON Transition Time* GUI menu (Chapter 10.3) and starts automatically after the 12V power supply is connected. It can be enabled also from *Power ON* GUI button (Chapter 10.6). A group of timing delays is added to the selected output interval, as follows:

1. First channel delay: **selected time interval and 2.1ms delay** added from power supply stabilization and system initialization (Chapter 5.1): initialization of variables and hardware components, read data flash and start first timer delay. This delay is available for start-up sequence. For GUI *Power On* selection, the added delay is about 1.3ms.

Example:

For the first output channel: if 10ms is configured as time value, the real delay between 12V power supply rising edge and enable first channel will be 12.1ms.

2. The other channel's delay: **selected time interval and 3.7ms delay**. A soft-start time from IC converter is added to the *Power On* sequence time delay. It represents the delay between enable chip and Power-Good response to uC. The rising edge delay for the output channel is around 1.9ms, and the Power Good transitions high about 1.5ms after the switching regulator's output voltage reaches the regulation threshold, which is typically 85% of the regulated output voltage.

The user can extend the soft start time, by connecting a capacitor between SS pin and ground for each channel, according to the next equation:

$$C_{ss} [nF] = 3.7 * t_{ss} [msec] - 1.6nF$$

where t_{ss} represents the soft-start interval of the converter.

Example:

For output channels except the first one: if 10ms is configured as channel timing, the real delay will be 13.7ms.

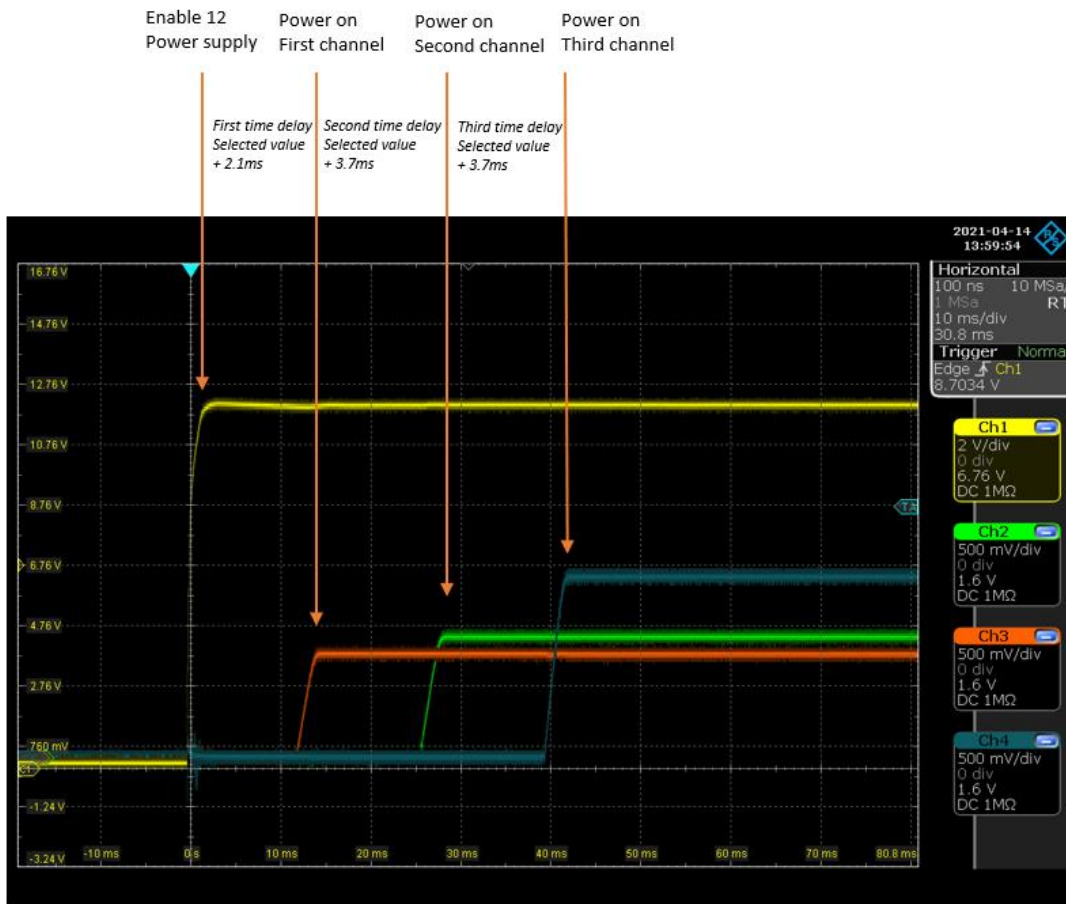

Figure 1. Power on time delay

- The Power Off delay can be configured from the *Set OFF Transition Time* GUI menu (Chapter 10.4) and is enabled from *Power OFF* GUI button (Chapter 10.6). An 18us Power Good falling edge delay is added to the selected value.

Note. In case the GUI scope is enabled, the ADC conversion and UART transmission will introduce a delay of 250us for both Power On and Power Off sequences time.

3. Physical Structure

3.1 Structure

The EU096 Flexible 6-Channel Power Sequencer demonstrator board provides the following structure:

- RL78/G12 microcontroller 30 pins – low power and high performance
- RL78/G1C microcontroller for UART communication
- A green presence LED when Power Sequencer is working
- A red presence LED for error and UART communication
- A debugger connector – available for debugging or flashing.

3.2 Hardware block diagram

The following figures show the hardware blocks available for:

- **Development board:** The hardware block diagram of the entire Power Sequencer PoC is presented below. The RL78/G12 master unit enables programmable delays, senses the main input voltage via ADC of the microcontroller, monitors each single power rail via MCU-integrated ADC, reads the Power good-signals of each DC/DC Converter and establishes an UART communication with the GUI.

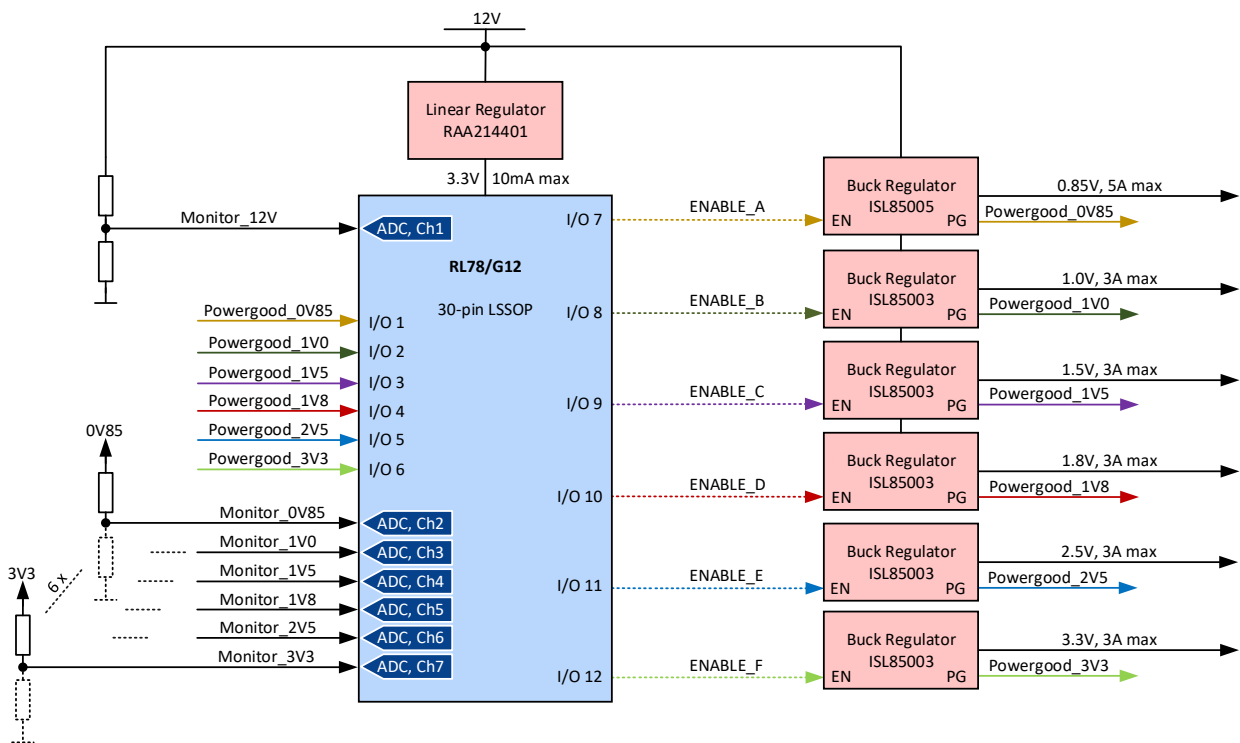

Figure 1. Power Sequencer Hardware block diagram

- **Building the RL78/G12 microcontroller:** In the current configuration are present: 3 Timer Array Unit channels (one for power sequence delay, one for led blinking and the last one for sending ADC values to GUI), GPIOs – for enable/disable channels, A/D converter – 7 channels, and Interrupt control – 6 channels from Power Good output.

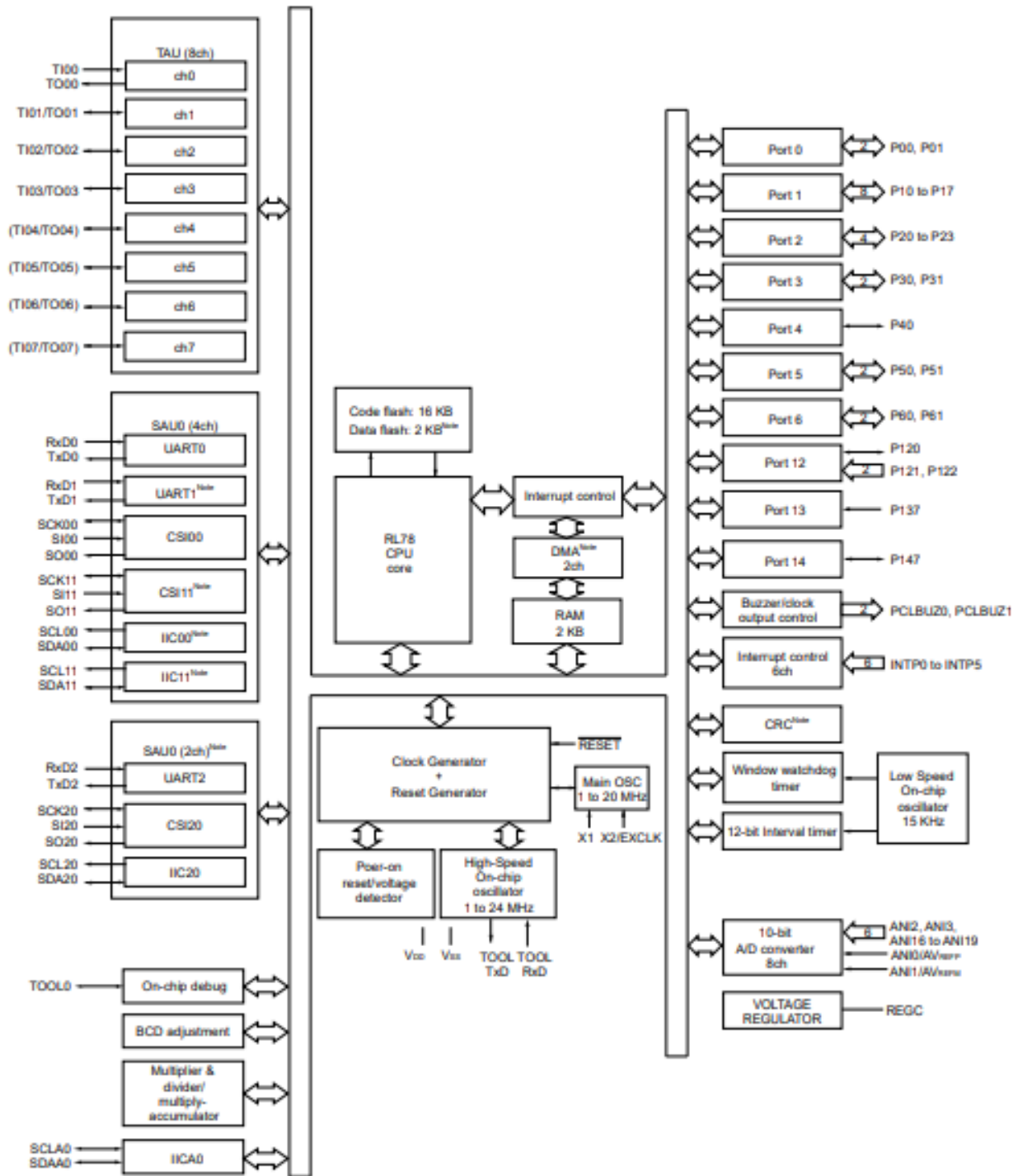

Figure 2. RL78/G12 block diagram

4. Software Layer

4.1 Layering

The following diagram represents the software layer model.

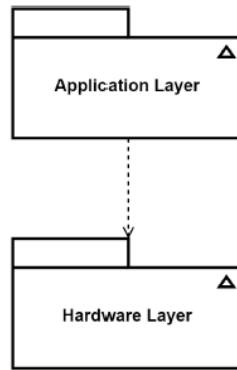

Figure 3. Software layers

The **Application Layer** implements the functionality of the Power Sequencer. This layer contains:

- System initialization (SINI).
- Specific functionalities implementation: update power ON time, update power OFF time, read ADC channels, enable power on/off delay, enable/disable power channel, set user Led state, data flash communication (APP).

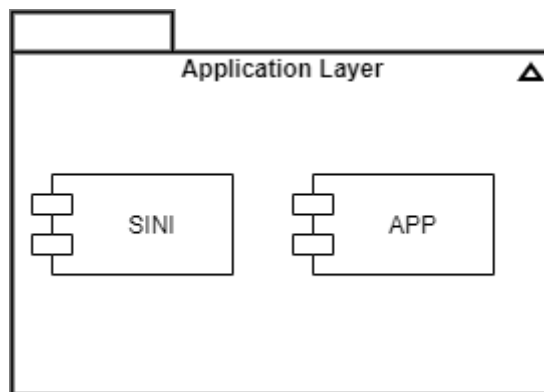

Figure 4. Application layer structure

The **Hardware Layer** is responsible for interfacing the MCU hardware components of the system with the rest of application. The main content of this layer are the drivers of the MCU, which are generated and configured into E2Studio IDE.

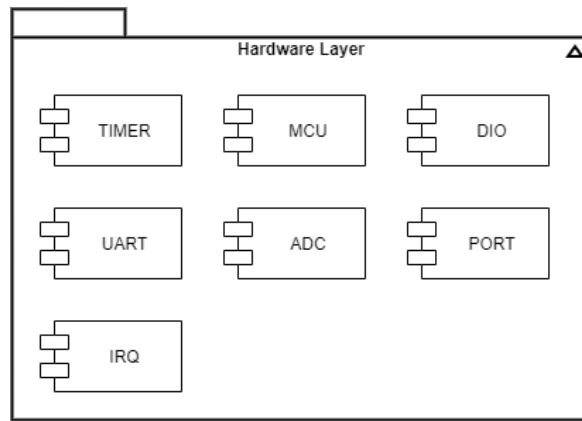

Figure 5. Hardware layer structure

4.2 Subsystems

Next image represents the software components diagram, and for each subsystem, the detailed modules:

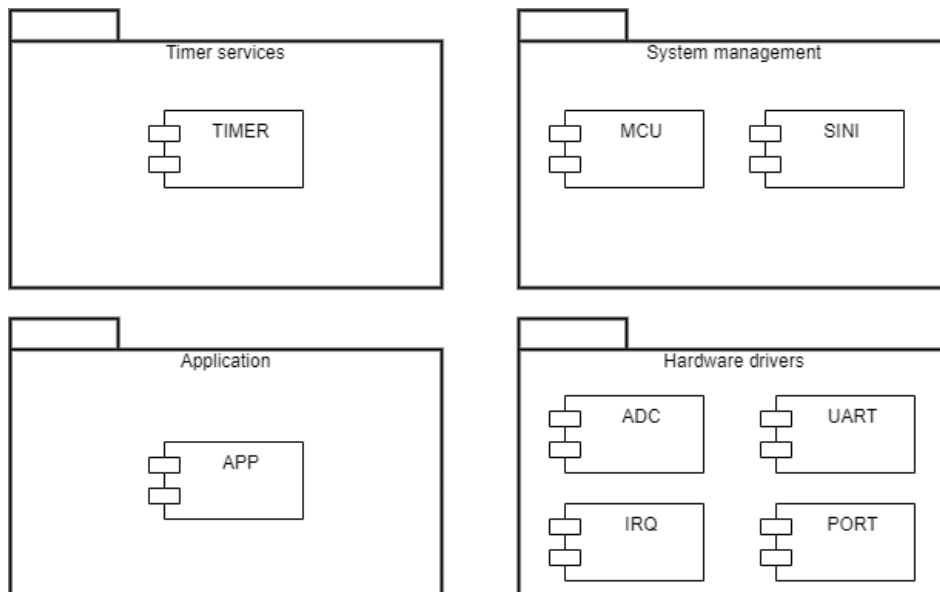

Figure 6. Software component's structure

Timer services – This module is responsible for providing the correct timing for measurements, like the timing used for power sequence, the timing used for blink user Led, or the timing used for sending ADC values to the GUI oscilloscope.

System management – This software module contains modules and functions used for the initialization and management of the system.

Application – This component includes all customer specific functionalities.

Hardware driver – This module contains all hardware drivers and hardware-linked modules in the system.

5. Context Management

5.1 System Initialization

The following activity diagram shows the sequence after power-on reset:

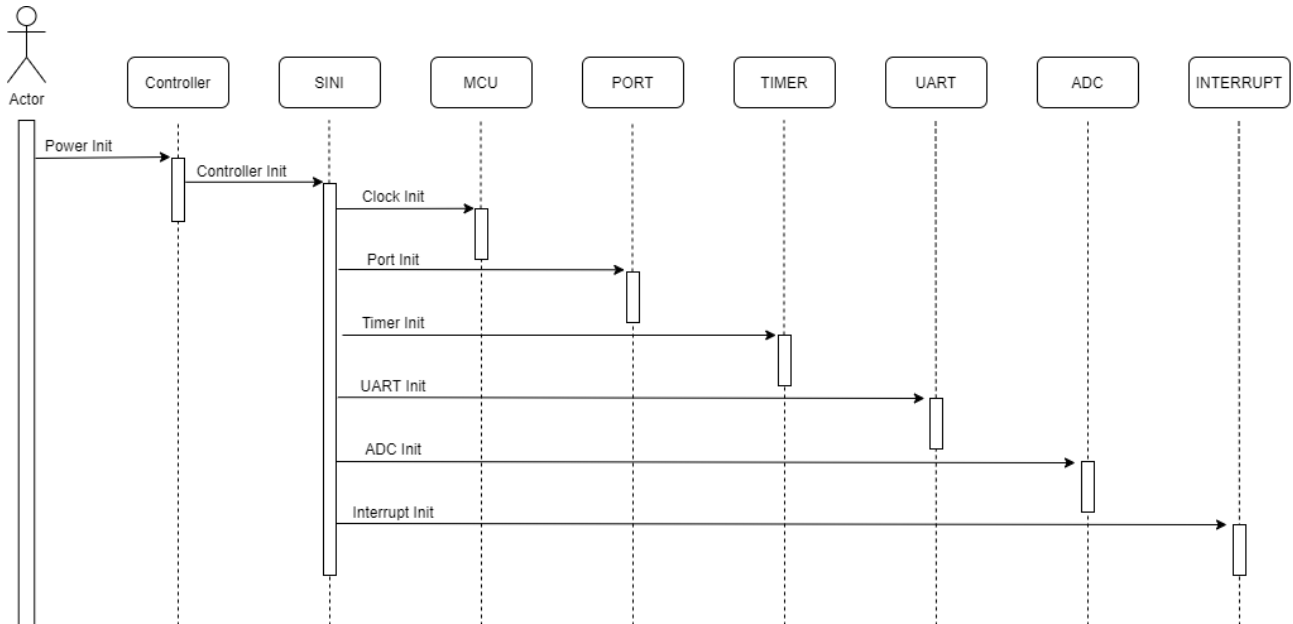

Figure 7. Power ON reset sequence

The first step after power-on reset is the basic controller initialization. This is followed by the initialization the clock tree and microcontroller hardware components. The sequence is finished with initialization of AFE IC ports.

5.2 Interrupts

The next table presents all the interrupts used in the Power Sequencer:

Interrupt	Priority	Description
r_intc0_interrupt	Level1	Feedback from the 0v85 channel
r_intc1_interrupt	Level1	Feedback from the 1v channel
r_intc2_interrupt	Level1	Feedback from the 1v5 channel
r_intc3_interrupt	Level1	Feedback from the 1v8 channel

r_intc4_interrupt	Level1	Feedback from the 2v5 channel
r_intc5_interrupt	Level1	Feedback from the 3v3 channel

5.3 Critical Sections

The critical section must be protected by disabling the interrupts during their run-time to avoid data mismatch across multiple modules or even software dead locks. As a result, the length of the interrupt locked section should be maintained to minimum.

In the current algorithm, the most sensitive sections are the channels monitoring and UART communication.

5.4 Synchronization

The communication on UART between the Power Sequencer board and GUI is done using a separate microcontroller (RL78 G1C). For synchronization it is required a baud rate of 115200.

The synchronization between the Power Sequencer and GUI is done when you are connecting to the board. The Power ON and Power OFF timers together with the outputs that are enabled/disabled are fetched from the board.

6. Mechanism

6.1 System State Model

6.1.1 Main application sequence Diagram

The following Sequence Diagram provides the main functionality of the EU096 Flexible 6-Channel Power Sequencer:

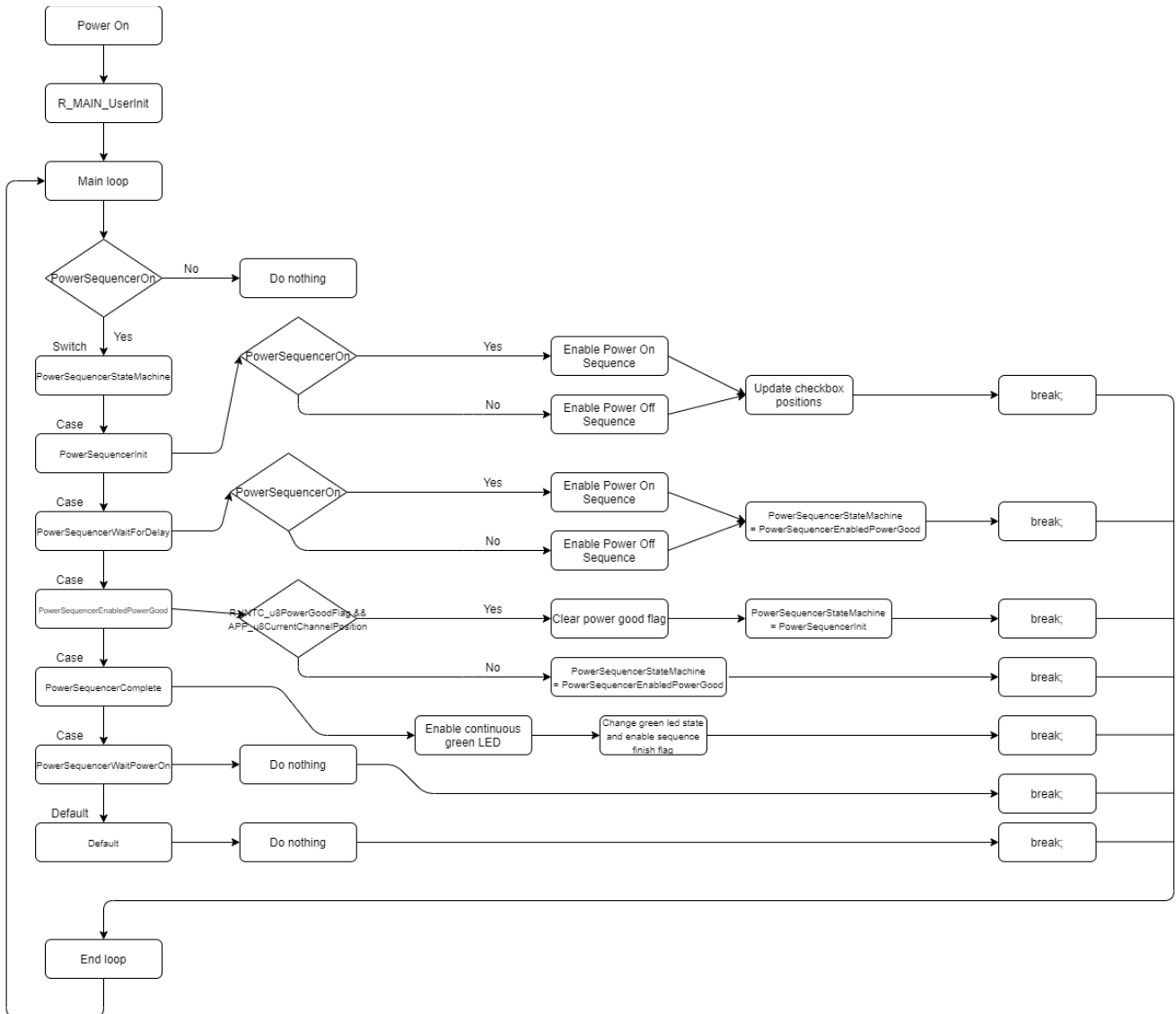

Figure 8. Main application sequence diagram

6.1.2 Power On/Off Sequence Diagram

The following Sequence Diagram provides the Power State Loop of the EU096 Flexible 6-Channel Power Sequencer:

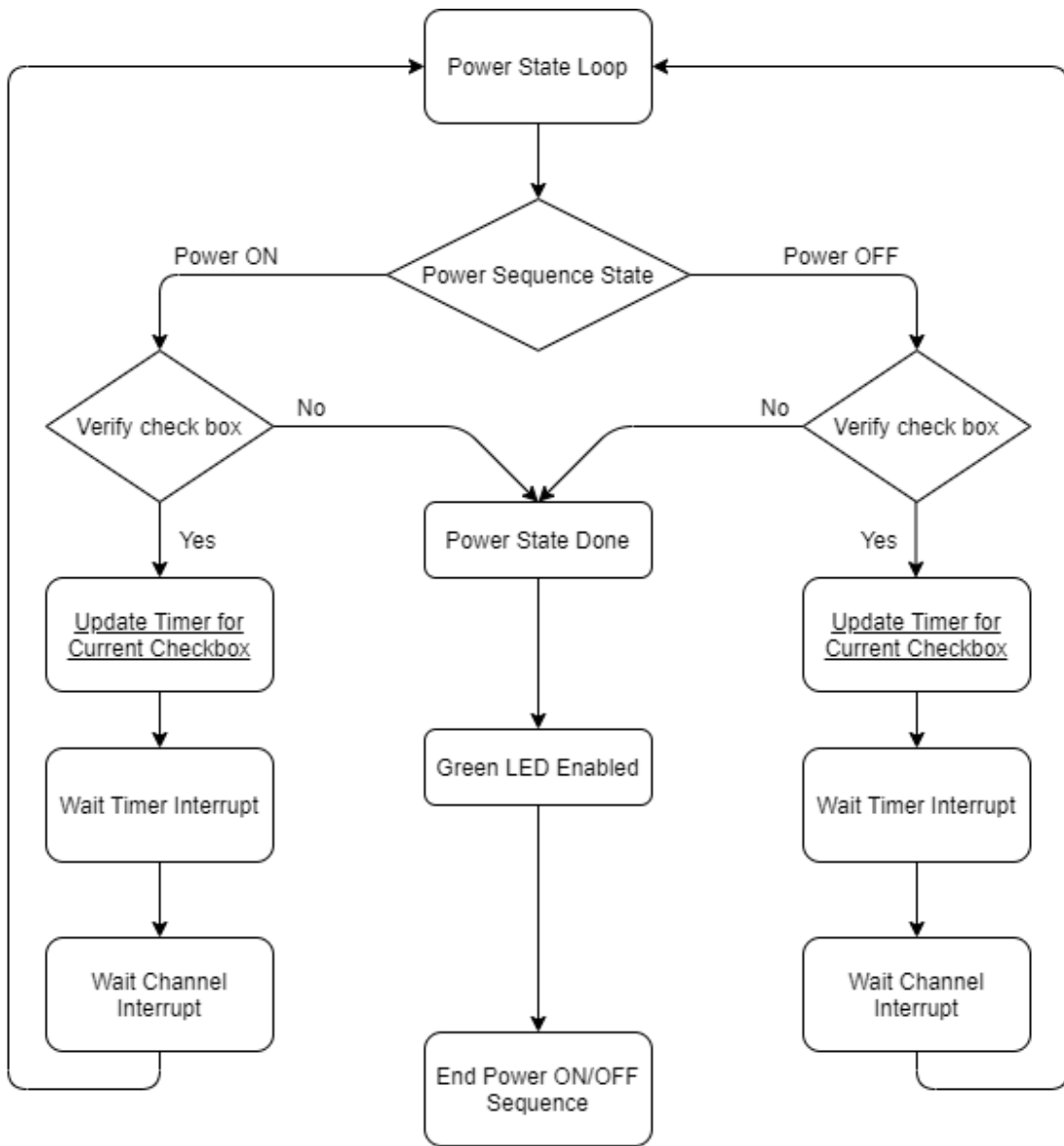

Figure 9. Power On/Off sequence diagram

7. Peripherals Configuration

This chapter presents the configuration of the peripherals used in the system. Before starting to configure the peripherals, it is necessary to assign fixed functions to some pins of the MCU. The setup for the fixed pins is presented in the following figures.

7.1 Fixed Function Assignments

PIOR0 bit = 1
 PIOR1 bit = 1
 PIOR2 bit = 1

When it's decided once, it isn't possible to change it later.
It's necessary to make a project again to change it.

Fix settings

Pin	Function
P17	TI02/TO02
P31	TI03/TO03
P11	RxD0/SI00/SDA00
P12	TxD0/SO00
P10	_SCK00/SCL00
P14	RxD2/SI20/SDA20
P13	TxD2/SO20
P15	_SCK20/SCL20
P60	SCLA0
P61	SDAA0

Figure 10. Fix settings

Once these settings have been applied, no more changes are allowed, only if a new configuration is started.

7.2 Clock tree

The RL78/L1C clock tree is based on the internal high-speed on-chip oscillator configured at 16MHz working frequency. This frequency value provides the lower power consumption.

Operation mode setting

High speed main mode 4.0 (V) ≤ VDD ≤ 5.5 (V)
 High speed main mode 3.6 (V) ≤ VDD ≤ 5.5 (V)
 High speed main mode 2.7 (V) ≤ VDD ≤ 5.5 (V)
 High speed main mode 2.4 (V) ≤ VDD ≤ 5.5 (V)
 Low speed main mode 1.8 (V) ≤ VDD ≤ 5.5 (V)

Main system clock (fMAIN) setting

High-speed OCO (fIH) High-speed system clock (fMX) ⓘ

High-speed OCO clock setting

Operation Frequency: (MHz)

High-speed system clock setting

Operation ⓘ
 X1 oscillation (fX) External clock input (fEX)

Frequency: (MHz)
 Stable time: (μs)

Internal low-speed oscillation clock (fIL) setting

Frequency: (kHz)

Interval timer operation clock setting

Interval timer operation clock: (kHz)

CPU and peripheral clock setting

CPU and peripheral clock (fCLK): (kHz)

Figure 11. Clock settings

7.3 On-Chip Debugging

In the same configuration window, only for debugging mode it is necessary to set the On-chip debug operation setting to Used and select the emulator model for debugging or flashing.

On-chip debug operation setting

Unused Used

Emulator setting

E1/E20 E2 E2 Lite

Pseudo-RRM/DMM function setting

Used Unused

Start/Stop function setting

Used Unused

Monitoring point function setting

Used Unused

Security ID setting

Use Security ID
 Security ID:

Security ID authentication failure setting

Do not erase flash memory data
 Erase flash memory data

Figure 12. On-chip debug operation setting

7.4 Reset Source / Output Function

It is recommended to enable the reset source of the system, to be able to determine the last reset source. The option Output the function for confirming reset source must be selected from the Confirming reset source tab.

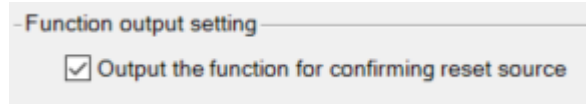

Figure 13. Function output setting

7.5 Port function / Pin assignments

The RL78/G12 model R5F102A7, provides 30 digital I/O pins which can control a variety of operations. In addition, these pins have several alternative functions.

7.5.1 Port 0 setup:

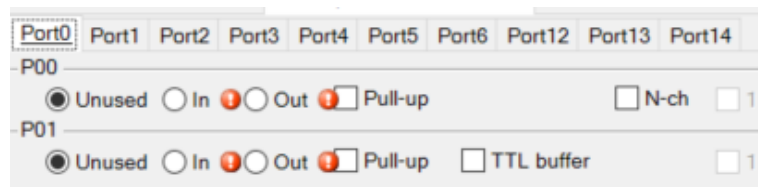

Figure 14. Port0 setup

7.5.2 Port 1 setup:

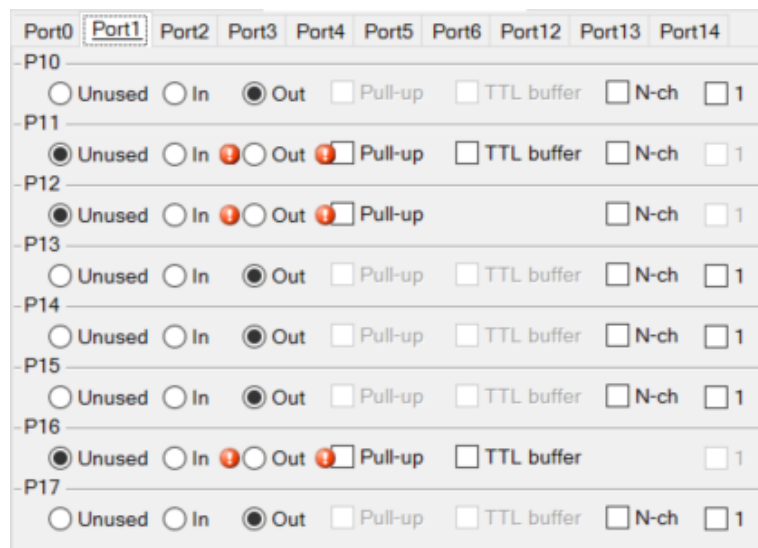

Figure 15. Port1 setup

7.5.3 Port 2 setup:

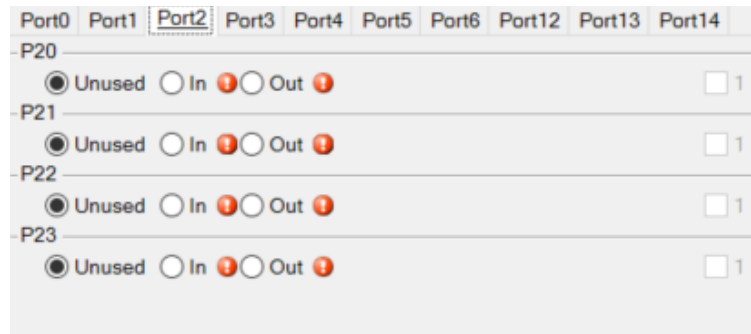

Figure 16. Port2 setup

7.5.4 Port 3 setup:

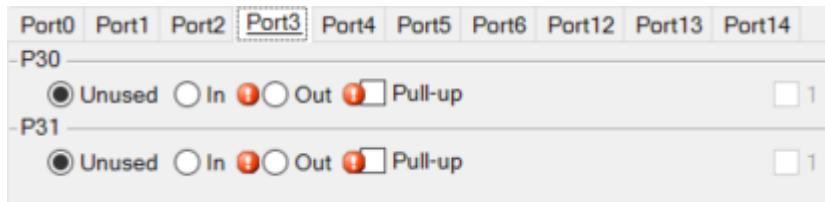

Figure 17. Port3 setup

7.5.5 Port 4 setup:

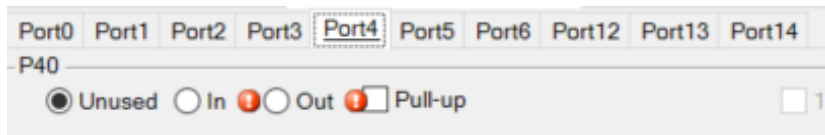

Figure 18. Port4 setup

7.5.6 Port 5 setup:

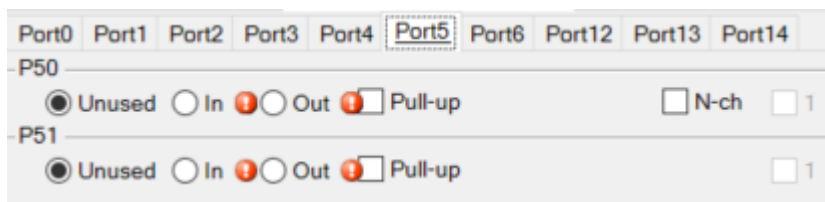

Figure 19. Port5 setup

7.5.7 Port 6 setup:

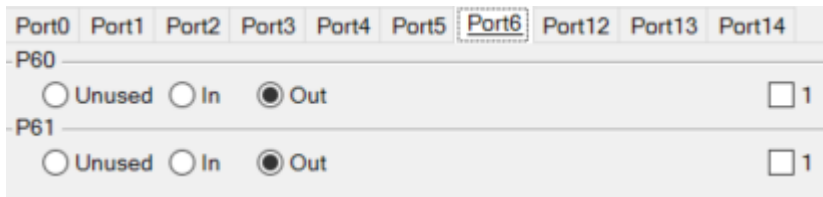

Figure 20. Port6 setup

7.5.8 Port 12 setup:

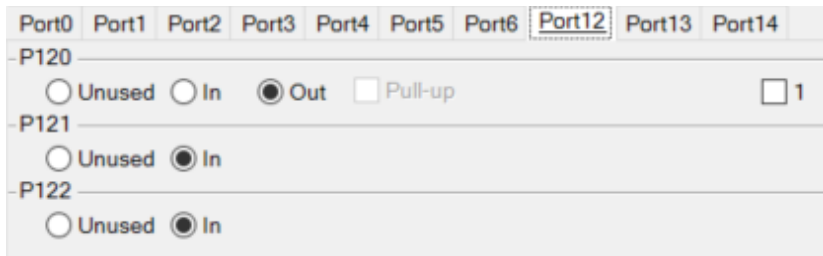

Figure 21. Port12 setup

7.5.9 Port 13 setup:

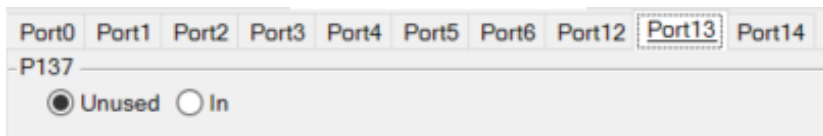

Figure 22. Port13 setup

7.5.10 Port 14 setup:

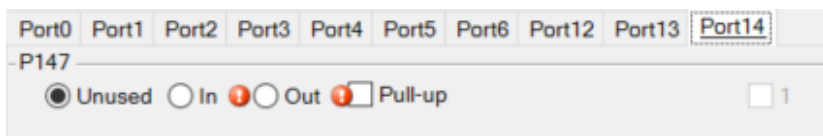

Figure 23. Port14 setup

7.5.11 Port Configuration Summary

The table below represents the description of port configuration.

PORT	State	Description
P10	OUT	Output 1v8
P13	OUT	Output 2v5
P14	OUT	Output 3v3
P15	OUT	Output 1v5
P17	OUT	Output 0v85
P60	OUT	Green LED
P61	OUT	Red LED
P120	OUT	Output 1v
P121	IN	External Clock (not used)
P122	IN	External Clock (not used)

7.6 External Interrupt

In the present configuration a single external interrupt is necessary, used for User Button, which is configured to both rising and falling edge mode.

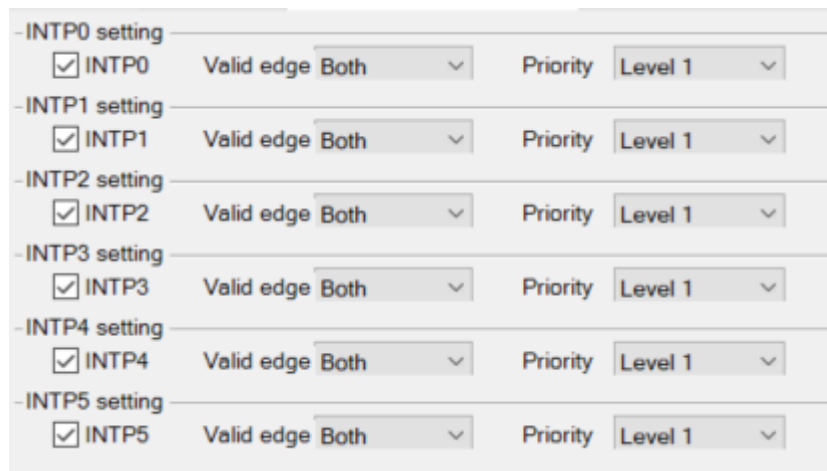

Figure 24. External interrupt configuration

7.7 A / D Converter

The A/D Converter of the RL78/G12 Microcontroller is used for:

- reading the voltages on the outputs and power supply

- A/D convertor operation setting

Unused Used

- Comparator operation setting

Stop Operation

- Resolution setting

10 bits 8 bits

- VREF(+) setting

VDD AVREFP Internal reference voltage

- VREF(-) setting

VSS AVREFM

- Trigger mode setting

Software trigger mode
 Hardware trigger no wait mode
 Hardware trigger wait mode

INTTM01

- Operation mode setting

Continuous select mode Continuous scan mode
 One-shot select mode One-shot scan mode

ANI0 - ANI3 analog input selection ANI0 - ANI3

ANI16 - ANI19 analog input selection

ANI16 ANI17 ANI18 ANI19 

A/D channel selection ANI16

- Conversion time setting

Conversion time mode Low-voltage 1

Conversion time 19 (304/fCLK) (μs)

- Conversion result upper/lower bound value setting

Generates an interrupt request (INTAD) when $ADLL \leq ADCRH \leq ADUL$
 Generates an interrupt request (INTAD) when $ADUL < ADCRH$ or $ADLL > ADCRH$

Upper bound (ADUL) value 255

Lower bound (ADLL) value 0

- Interrupt setting

Use A/D interrupt (INTAD)

Priority Low

Figure 25. ADC configuration

7.8 Timer Array Unit

The Timer Array Unit has 8 channels but only 3 of them are configured as following:

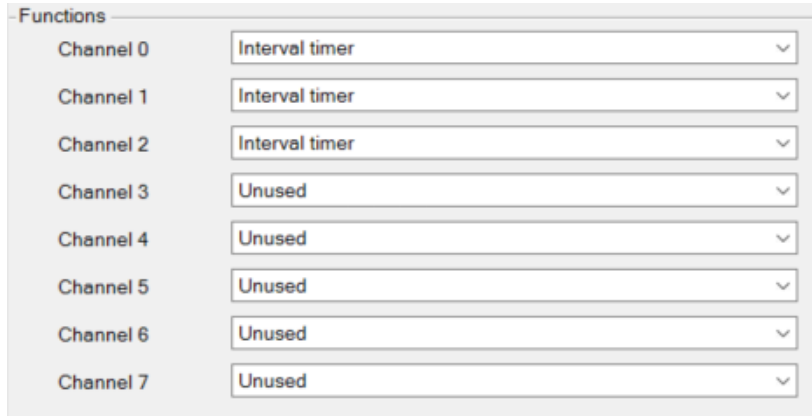

Figure 26. Timer array unit configuration

7.8.1 Channel 0

Timer 0 is used for the Power On of the 6 channels (used for calculating the time between each enable).

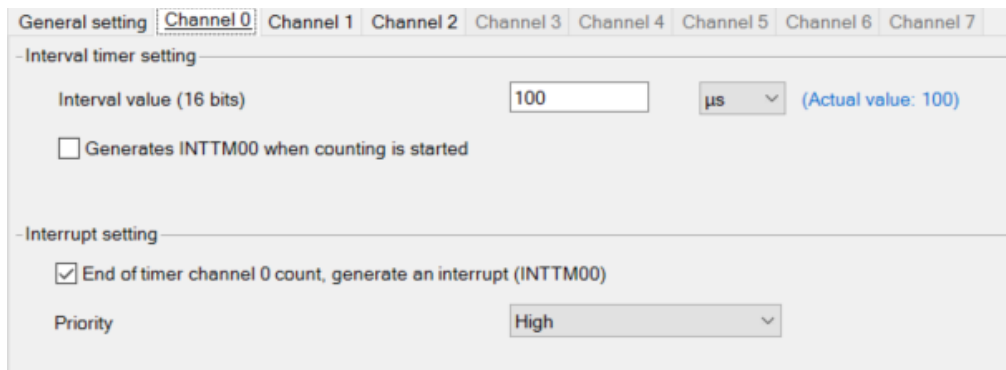

Figure 27. Channel 0 configuration

7.8.2 Channel 1

Timer 1 is used for the Green LED.

Figure 28. Channel 1 configuration

7.8.3 Channel 2

Timer 3 is used for the UART communication.

Figure 29. Channel 2 configuration

8. Functional Design

This chapter contains information about the implemented modules and their interfaces.

8.1 Component Interfaces

8.1.1 Application Module Interface

Interface	Description
void main(void);	Main function where the main loop is
void R_MAIN_UserInit(void);	Initialization Function
uint16_t APP_u16ReadADC(void);	Read ADC values for the 6 channels and power supply
void APP_vSaveValuesToFlash(APP_stPowerTime* inputBuffer);	Save values to flash into a buffer
void APP_vGetValueFlash(void);	Read values from flash
uint8_t APP_vEnablePowerOnDelay(uint8_t ChannelPosition);	Set delay to power on for each individual channel
uint8_t APP_vEnablePowerOffDelay(uint8_t ChannelPosition);	Set delay to power off for each individual channel
void APP_vEnablePowerOnChannel(uint8_t ChannelPosition);	Enable the output for each individual channel
void APP_vEnablePowerOffChannel(uint8_t ChannelPosition);	Disable the output for each individual channel
void APP_vUpdateCheckBox(void);	Update the GUI with the channels that are active
void APP_vPowerOnDone(void);	Function to be called when Power ON was successful
void APP_vUserLed(tLedState localLedState);	Function to enable or disable the green LED

8.1.2 UART Communication

void UART_vHandleReceiveData(void);	Handle the conversion from UART
void UART_vHandleEventData(uint16_t rx_data_handle);	Handle the messages based on the ID
void UART_vUpdateADC_ConsoleLog(void);	Handle the message that will be sent to GUI regarding the raw values of the output voltages
void UART_vSendPowerTime_ConsoleLog(void);	Send the message via UART to GUI

9. Software-Update

The application can be updated using the E1 Renesas debugger and Renesas Flash Programmer tool. This feature is available both for data and code flash. To be able to do this, it is required to have a *.hex file that contains the data flash parameter values or a new version of firmware. The next steps should be followed: A new project must be created.

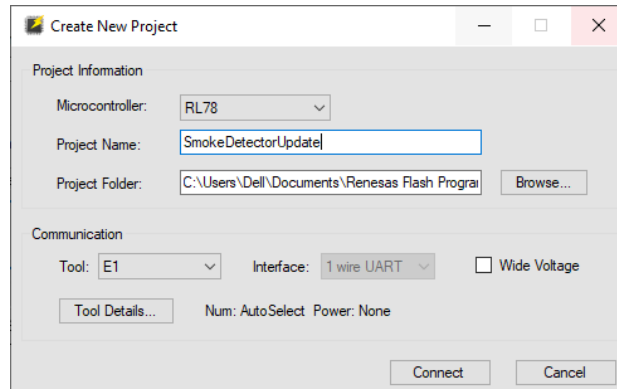

Figure 30. Creating a new project

Connect to the development board. Load the .hex file using *Browse* button and finally press *Start* to start flashing the new dataset.

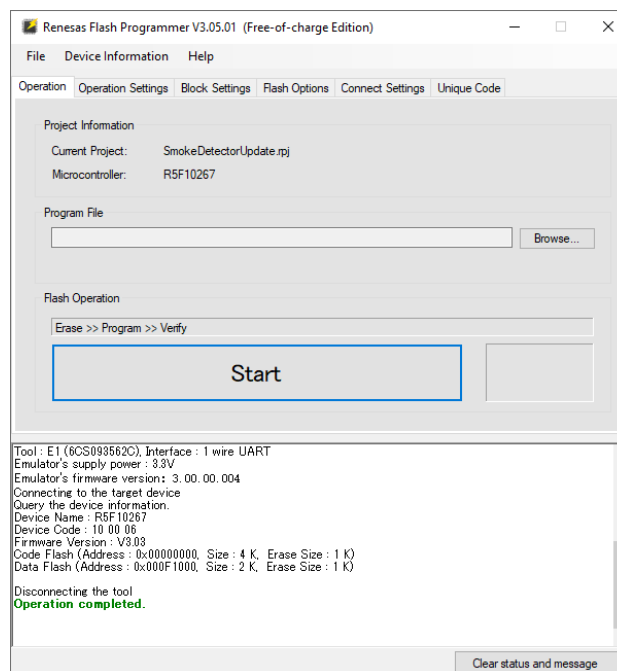

Figure 31. Connect to the development board

10. GUI – Graphical User Interface

The Graphical User Interface was implemented for an easier configuration of the Renesas EU096 Flexible 6-Channel Power Sequencer parameters. It has also a visual representation of the output signals from the board. The communication is handled through UART.

10.1 System Information

The System Information tab provides information related to the Application Version and Release Date.

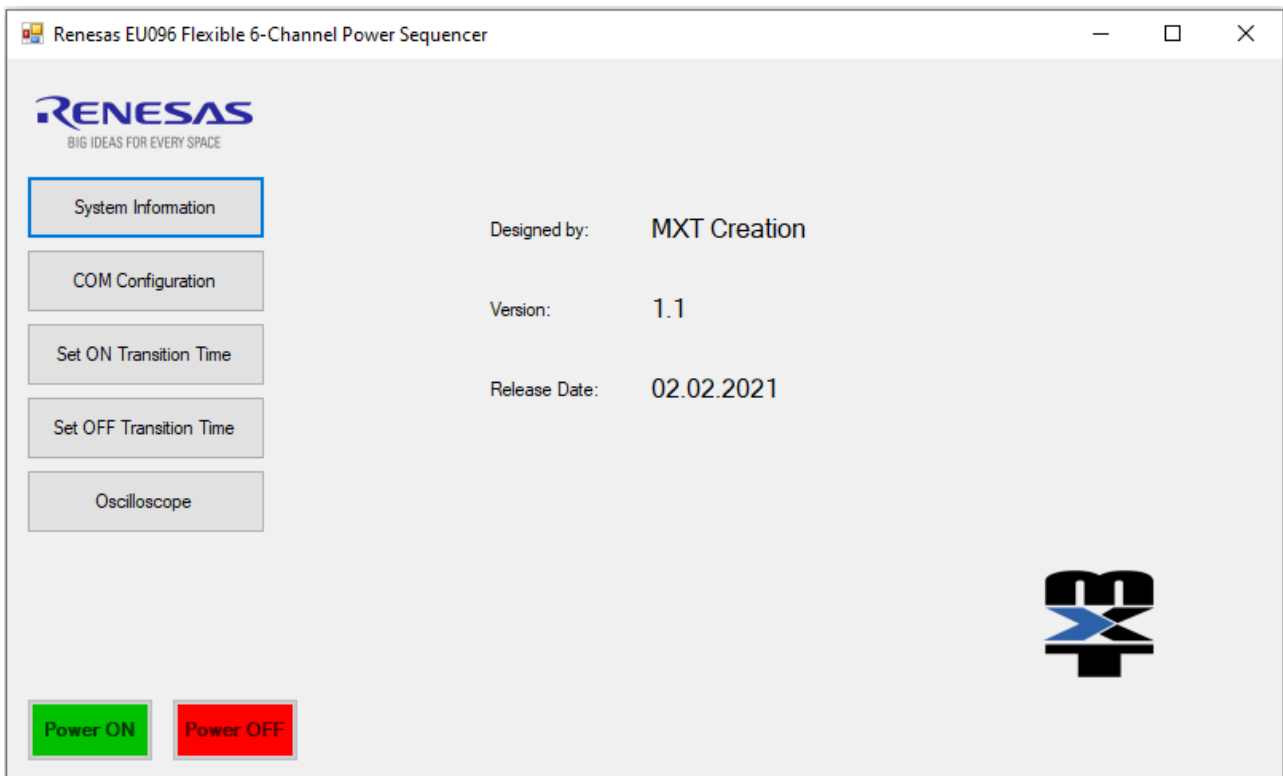

Figure 32. System Information tab

10.2 COM Configuration

The connection to the board is realized in the "COM Configuration" tab. The communication is done using UART protocol.

Only the Port on which the Renesas EU096 Power Sequencer is connected must be selected. All other COM properties are set by default to the following values:

Baud Rate : 115200;

Data Bits: 8;

Stop Bits: One;

Parity Bits: None;

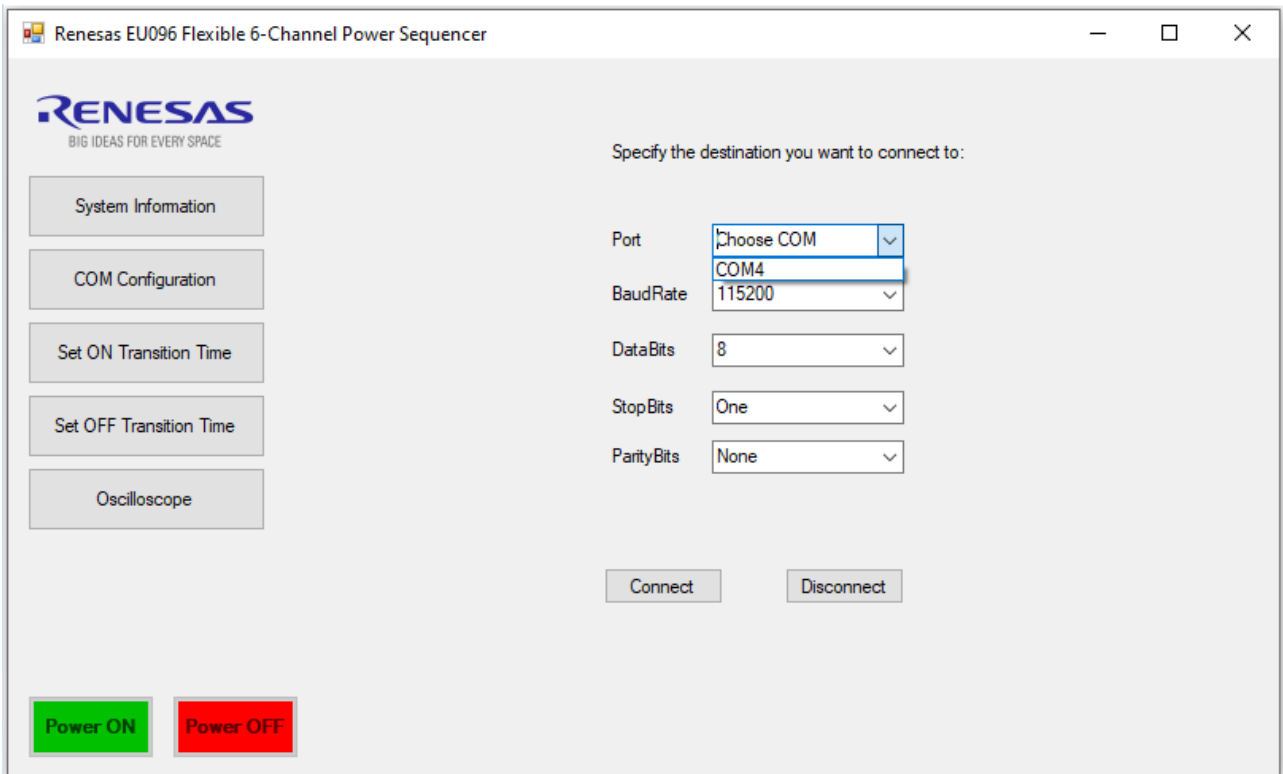

Figure 33. COM configuration tab

After selecting the correct Port, you should press Connect Button in order to establish connection.

If a different Port should be used, pressing Disconnect Button, selecting a different Port and pressing Connect Button again will do.

A cyclical check is done every 5 seconds to verify if the connection is still active. If the communication is closed, a pop up warning will notify the user that the serial communication has been closed.

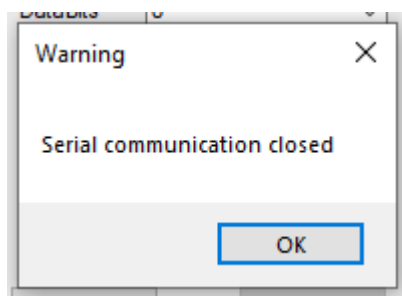

Figure 34. Serial communication warning

10.3 Set ON Transition Time

This screen tab allows the user to individually modify the delays between each regulator enable.

On the top half of the tab there is a graph to help the user understand how the enable sequence is done on the Renesas EU096 board. The second half provides each individual timer to be set by the user. Values

introduced in these fields must be unsigned integers type in the interval 1-65535. The values set are in microseconds unit. If a connection was established in the “Com Configuration” tab, the current settings of the board for each corresponding output are showed.

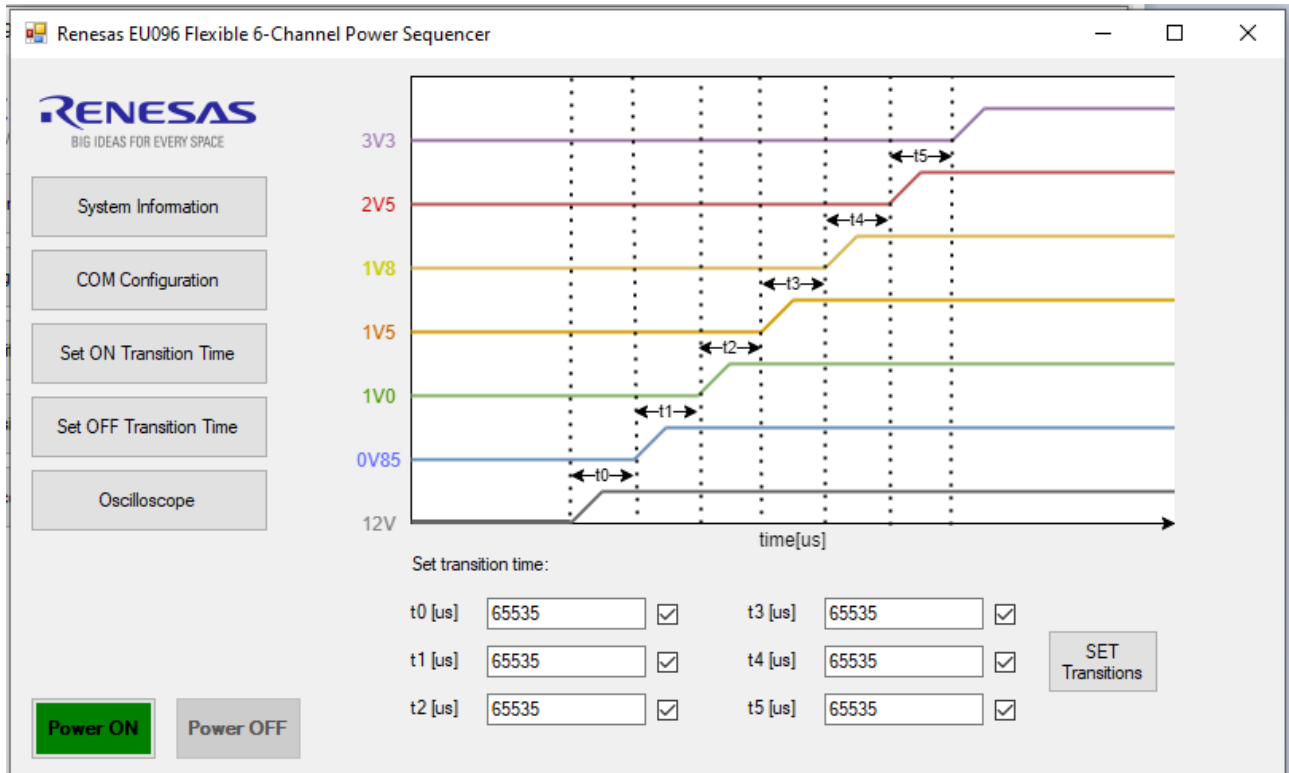

Figure 35. Set ON Transition Time tab

If the user wants to change the timer values this can be done for each output individually. The values represent the time it takes an output to be enabled after the previous output was enabled. (ex: $t_0 = 10.000$ it will take the 0V85 output 10 milliseconds to enable after the 12V was enabled). After all values are set, the user should press Set Transitions button. The new values will be saved in the data flash of the microcontroller. After a Power Off – Power On sequence is done the new timers will be applied.

All value boxes should be filled in order to set a new transition, otherwise a pop-up warning will inform the user to complete them.

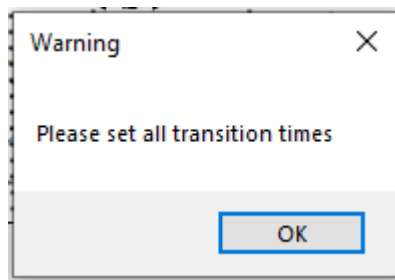

Figure 36. Transition time warning

The user can also check the box for each output if they want to enable it. If a connection was established in the “Com Configuration” tab, the current settings of the board for each corresponding output are showed. If the checkbox is enabled, the corresponding output is enabled. If you hover the mouse over the checkbox, the user will be informed regarding which output he enables/ disables. These options are duplicated in the “Set OFF Transition Time” screen.

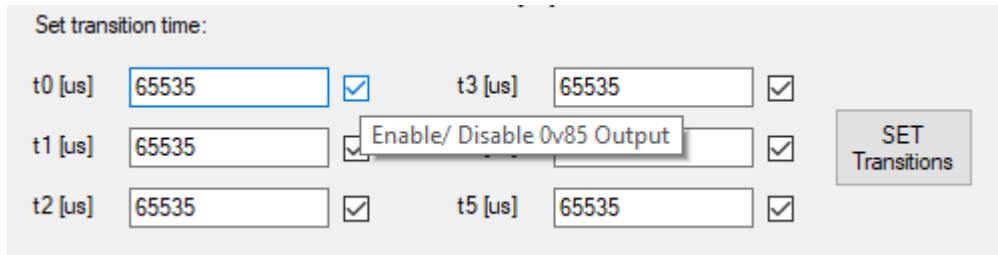

Figure 37. Check box information.

10.4 Set OFF Transition Time

This screen tab allows the user to individually modify the delays between each regulator disable.

On the top half of the tab there is a graph to help the user understand how the disable sequence is done on the Renesas EU096 board. The second half provides each individual timer to be set by the user. Values introduced in these fields must be unsigned integers in the interval 1-65535. The values set are in microseconds. If a connection was established in the “Com Configuration” tab, the current settings of the board for each corresponding output are showed.

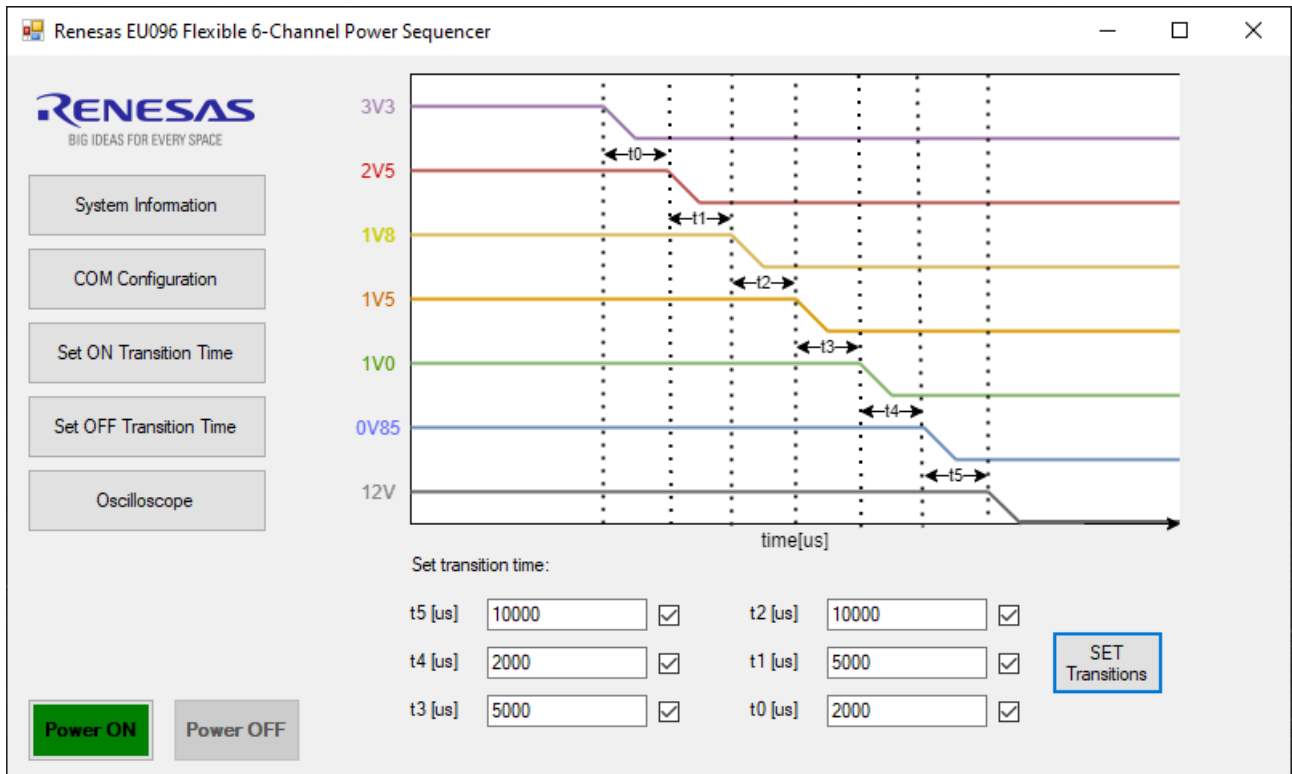

Figure 38. Set OFF Transition Time tab

If the user wants to change the timer values this can be done for each output individually. The values represent the time it takes an output to be disabled after the previous output was disabled. (ex: $t_0 = 10.000$ it will take the 0V85 output 10 milliseconds to disable after the 1V was disabled). After all values are set, the user should press Set Transitions button. The new values will be saved in the data flash of the microcontroller. After a Power Off – Power On sequence is done the new timers will apply.

All value boxes should be filled in order to set a new transition, otherwise a pop-up warning will inform the user to complete them.

<i>Page Setup...</i>	Does nothing.
<i>Print...</i>	Prints the graph.
<i>Show Point values</i>	Shows the values while you hover with the mouse over.
<i>Un-Zoom</i>	Reverses zoom with one step.
<i>Undo all Zoom/Pan</i>	Resets all zooms and goes to default 4V and 10 seconds.
<i>Set scale to default</i>	Automatically scales the graph.

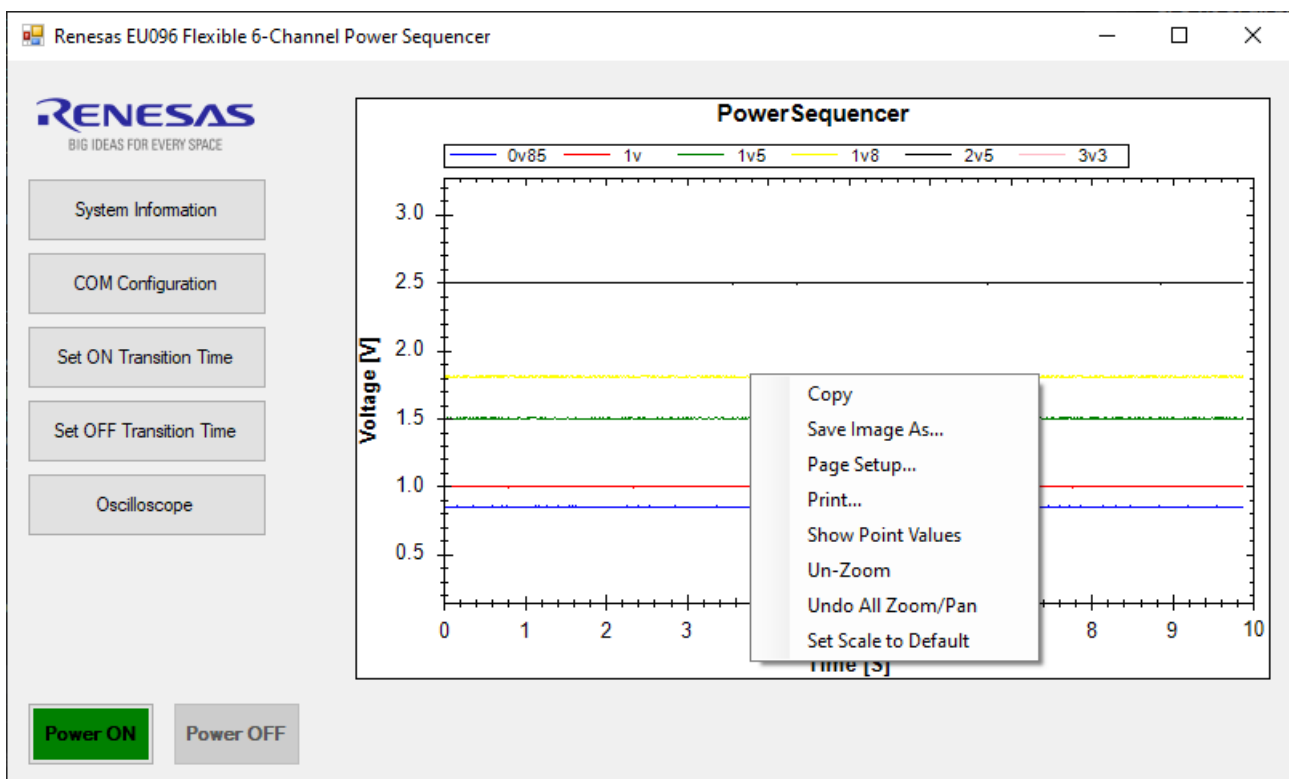

Figure 41. Right click options

10.6 Power On/ Power Off

On the left bottom side there are two buttons that enable and disable the selected outputs.



The options are disabled only if a connection is established. If a connection was established in the “COM Configuration” tab, the current settings of the board for the Output Enabled or Output Disabled is provided.

If the user presses on the available option, it will be grayed out and disabled. The alternative option is colored and enabled.

Power On sequence:

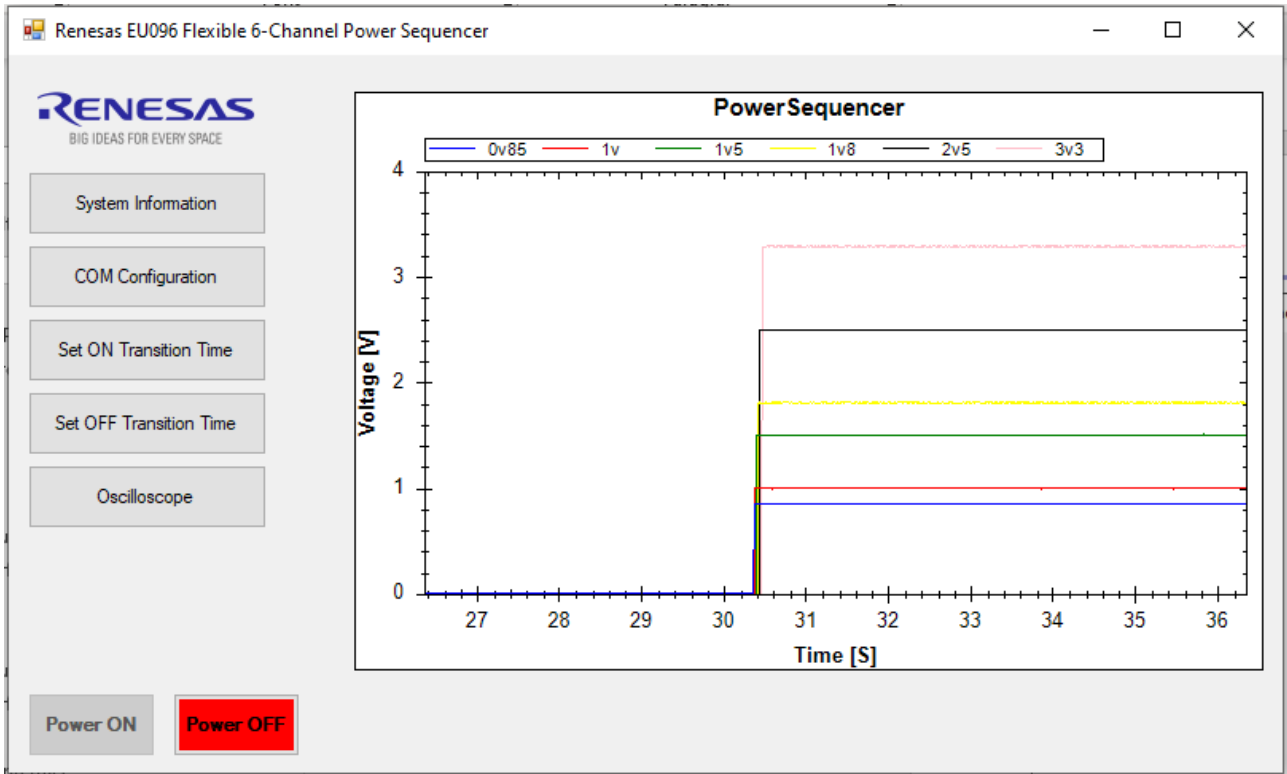

Figure 42. Power ON sequence

Power Off sequence:

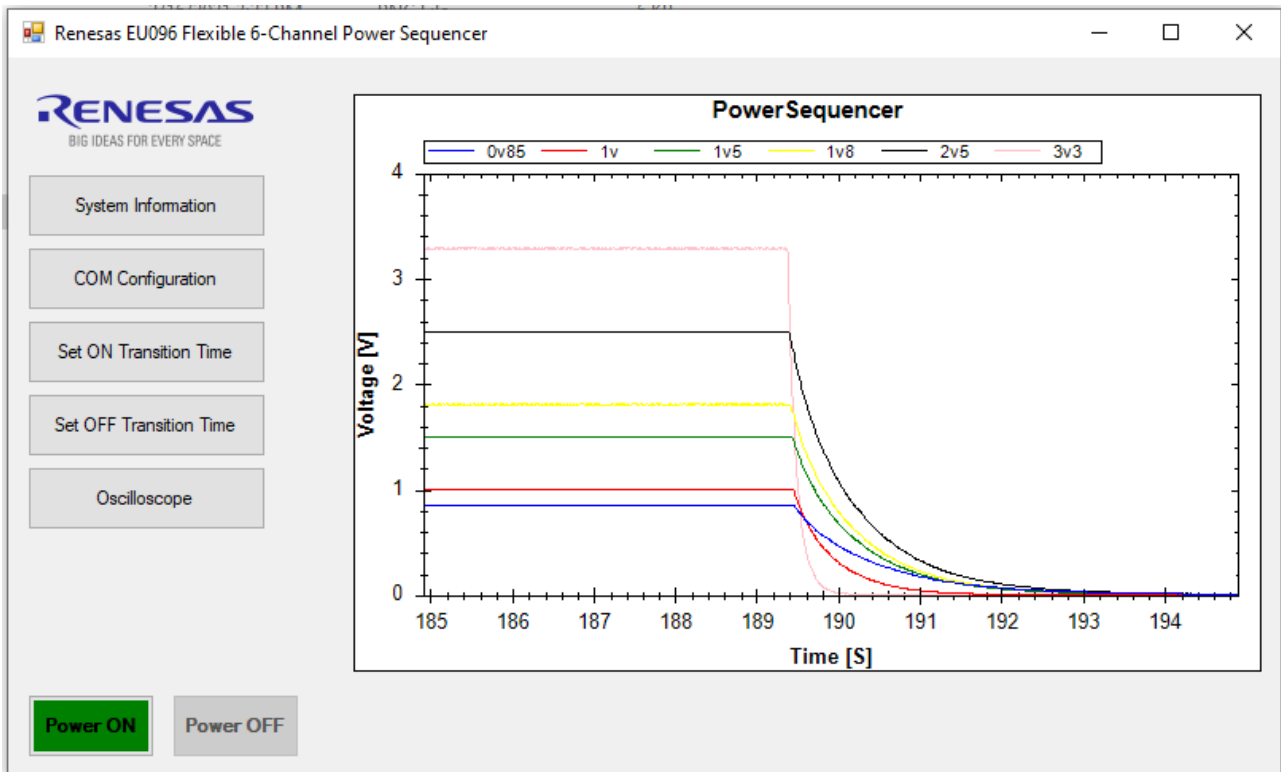

Figure 43. Power OFF sequence

10.7 Data Handling

The following data is transferred between the board and GUI with the following IDs:

- 0x20 – The timing values at Power On for the 6 channels and a bit for each representing if it is enabled or disabled.
- 0x21 – The timing values at Power Off for the 6 channels and a bit for each representing if it is enabled or disabled.
- 0x22 – Request from GUI to enable cyclic communication at 10 ms in order to provide the voltages on the 6 channels and power supply.
- 0x23 – Request from GUI to disable cyclic communication.
- 0x24 – Reserved command
- 0x25 – Command for transmit power on and power off flash values after GUI connection is done.
- 0x26 – Command to trigger Power On
- 0x27 – Command to trigger Power Off

11. Nomenclature

- IC Integrated Circuit
- MCU Microcontroller
- AFE Analog front-end
- LED Light Emitting Diode
- PGA Programmable Gain Amplifier
- DAC Digital to Analog Converter
- A/D converter Analog to Digital Converter
- DAC Digital to Analog Converter
- UART Universal Asynchronous Receiver-Transmitter
- GPIO General-Purpose Input/Output
- SINI System Initialization
- APP Application
- IDE Integrated development environment

References

- [1] Renesas Electronics, "EU096 – Hardware User's Guide".
- [2] Renesas Electronics, "EU096 – Quick Start Guide".
- [3] Renesas Electronics, "RL78/G12 - User's Manual: Hardware" Jun. 2020 - R01DS0193EJ0230
- [4] Renesas Electronics, "E1/E20/E2 Emulator, E2 Emulator Lite - Additional Document for User's Manual - (Notes on Connection for RL78)", Jul. 2020 - R20UT1994EJ0702: [Link](#).

Revision History

Rev.	Date	Description	
		Page	Summary
1.0	11.01.2021		Initial version.
1.1	08.02.2021		Release candidate
1.2	26.02.2021		Document review
1.3	15.04.2021		Implement remarks from Renesas

General Precautions in the Handling of Microprocessing Unit and Microcontroller Unit Products

The following usage notes are applicable to all Microprocessing unit and Microcontroller unit products from Renesas. For detailed usage notes on the products covered by this document, refer to the relevant sections of the document as well as any technical updates that have been issued for the products.

1. Precaution against Electrostatic Discharge (ESD)

A strong electrical field, when exposed to a CMOS device, can cause destruction of the gate oxide and ultimately degrade the device operation. Steps must be taken to stop the generation of static electricity as much as possible, and quickly dissipate it when it occurs. Environmental control must be adequate. When it is dry, a humidifier should be used. This is recommended to avoid using insulators that can easily build up static electricity.

Semiconductor devices must be stored and transported in an anti-static container, static shielding bag or conductive material. All test and measurement tools including work benches and floors must be grounded. The operator must also be grounded using a wrist strap. Semiconductor devices must not be touched with bare hands. Similar precautions must be taken for printed circuit boards with mounted semiconductor devices.

2. Processing at power-on

The state of the product is undefined at the time when power is supplied. The states of internal circuits in the LSI are indeterminate and the states of register settings and pins are undefined at the time when power is supplied. In a finished product where the reset signal is applied to the external reset pin, the states of pins are not guaranteed from the time when power is supplied until the reset process is completed. In a similar way, the states of pins in a product that is reset by an on-chip power-on reset function are not guaranteed from the time when power is supplied until the power reaches the level at which resetting is specified.

3. Input of signal during power-off state

Do not input signals or an I/O pull-up power supply while the device is powered off. The current injection that results from input of such a signal or I/O pull-up power supply may cause malfunction and the abnormal current that passes in the device at this time may cause degradation of internal elements. Follow the guideline for input signal during power-off state as described in your product documentation.

4. Handling of unused pins

Handle unused pins in accordance with the directions given under handling of unused pins in the manual. The input pins of CMOS products are generally in the high-impedance state. In operation with an unused pin in the open-circuit state, extra electromagnetic noise is induced in the vicinity of the LSI, an associated shoot-through current flows internally, and malfunctions occur due to the false recognition of the pin state as an input signal become possible.

5. Clock signals

After applying a reset, only release the reset line after the operating clock signal becomes stable. When switching the clock signal during program execution, wait until the target clock signal is stabilized. When the clock signal is generated with an external resonator or from an external oscillator during a reset, ensure that the reset line is only released after full stabilization of the clock signal. Additionally, when switching to a clock signal produced with an external resonator or by an external oscillator while program execution is in progress, wait until the target clock signal is stable.

6. Voltage application waveform at input pin

Waveform distortion due to input noise or a reflected wave may cause malfunction. If the input of the CMOS device stays in the area between V_{IL} (Max.) and V_{IH} (Min.) due to noise, for example, the device may malfunction. Take care to prevent chattering noise from entering the device when the input level is fixed, and also in the transition period when the input level passes through the area between V_{IL} (Max.) and V_{IH} (Min.).

7. Prohibition of access to reserved addresses

Access to reserved addresses is prohibited. The reserved addresses are provided for possible future expansion of functions. Do not access these addresses as the correct operation of the LSI is not guaranteed.

8. Differences between products

Before changing from one product to another, for example to a product with a different part number, confirm that the change will not lead to problems. The characteristics of a microprocessing unit or microcontroller unit products in the same group but having a different part number might differ in terms of internal memory capacity, layout pattern, and other factors, which can affect the ranges of electrical characteristics, such as characteristic values, operating margins, immunity to noise, and amount of radiated noise. When changing to a product with a different part number, implement a system-evaluation test for the given product.

Notice

1. Descriptions of circuits, software and other related information in this document are provided only to illustrate the operation of semiconductor products and application examples. You are fully responsible for the incorporation or any other use of the circuits, software, and information in the design of your product or system. Renesas Electronics disclaims any and all liability for any losses and damages incurred by you or third parties arising from the use of these circuits, software, or information.
 2. Renesas Electronics hereby expressly disclaims any warranties against and liability for infringement or any other claims involving patents, copyrights, or other intellectual property rights of third parties, by or arising from the use of Renesas Electronics products or technical information described in this document, including but not limited to, the product data, drawings, charts, programs, algorithms, and application examples.
 3. No license, express, implied or otherwise, is granted hereby under any patents, copyrights or other intellectual property rights of Renesas Electronics or others.
 4. You shall not alter, modify, copy, or reverse engineer any Renesas Electronics product, whether in whole or in part. Renesas Electronics disclaims any and all liability for any losses or damages incurred by you or third parties arising from such alteration, modification, copying or reverse engineering.
 5. Renesas Electronics products are classified according to the following two quality grades: "Standard" and "High Quality". The intended applications for each Renesas Electronics product depends on the product's quality grade, as indicated below.
 - "Standard": Computers; office equipment; communications equipment; test and measurement equipment; audio and visual equipment; home electronic appliances; machine tools; personal electronic equipment; industrial robots; etc.
 - "High Quality": Transportation equipment (automobiles, trains, ships, etc.); traffic control (traffic lights); large-scale communication equipment; key financial terminal systems; safety control equipment; etc.
- Unless expressly designated as a high reliability product or a product for harsh environments in a Renesas Electronics data sheet or other Renesas Electronics document, Renesas Electronics products are not intended or authorized for use in products or systems that may pose a direct threat to human life or bodily injury (artificial life support devices or systems; surgical implantations; etc.), or may cause serious property damage (space system; undersea repeaters; nuclear power control systems; aircraft control systems; key plant systems; military equipment; etc.). Renesas Electronics disclaims any and all liability for any damages or losses incurred by you or any third parties arising from the use of any Renesas Electronics product that is inconsistent with any Renesas Electronics data sheet, user's manual or other Renesas Electronics document.
6. When using Renesas Electronics products, refer to the latest product information (data sheets, user's manuals, application notes, "General Notes for Handling and Using Semiconductor Devices" in the reliability handbook, etc.), and ensure that usage conditions are within the ranges specified by Renesas Electronics with respect to maximum ratings, operating power supply voltage range, heat dissipation characteristics, installation, etc. Renesas Electronics disclaims any and all liability for any malfunctions, failure or accident arising out of the use of Renesas Electronics products outside of such specified ranges.
 7. Although Renesas Electronics endeavors to improve the quality and reliability of Renesas Electronics products, semiconductor products have specific characteristics, such as the occurrence of failure at a certain rate and malfunctions under certain use conditions. Unless designated as a high reliability product or a product for harsh environments in a Renesas Electronics data sheet or other Renesas Electronics document, Renesas Electronics products are not subject to radiation resistance design. You are responsible for implementing safety measures to guard against the possibility of bodily injury, injury or damage caused by fire, and/or danger to the public in the event of a failure or malfunction of Renesas Electronics products, such as safety design for hardware and software, including but not limited to redundancy, fire control and malfunction prevention, appropriate treatment for aging degradation or any other appropriate measures. Because the evaluation of microcomputer software alone is very difficult and impractical, you are responsible for evaluating the safety of the final products or systems manufactured by you.
 8. Please contact a Renesas Electronics sales office for details as to environmental matters such as the environmental compatibility of each Renesas Electronics product. You are responsible for carefully and sufficiently investigating applicable laws and regulations that regulate the inclusion or use of controlled substances, including without limitation, the EU RoHS Directive, and using Renesas Electronics products in compliance with all these applicable laws and regulations. Renesas Electronics disclaims any and all liability for damages or losses occurring as a result of your noncompliance with applicable laws and regulations.
 9. Renesas Electronics products and technologies shall not be used for or incorporated into any products or systems whose manufacture, use, or sale is prohibited under any applicable domestic or foreign laws or regulations. You shall comply with any applicable export control laws and regulations promulgated and administered by the governments of any countries asserting jurisdiction over the parties or transactions.
 10. It is the responsibility of the buyer or distributor of Renesas Electronics products, or any other party who distributes, disposes of, or otherwise sells or transfers the product to a third party, to notify such third party in advance of the contents and conditions set forth in this document.
 11. This document shall not be reprinted, reproduced or duplicated in any form, in whole or in part, without prior written consent of Renesas Electronics.
 12. Please contact a Renesas Electronics sales office if you have any questions regarding the information contained in this document or Renesas Electronics products.

(Note1) "Renesas Electronics" as used in this document means Renesas Electronics Corporation and also includes its directly or indirectly controlled subsidiaries.

(Note2) "Renesas Electronics product(s)" means any product developed or manufactured by or for Renesas Electronics.

(Rev.4.0-1 November 2017)

Corporate Headquarters

TOYOSU FORESIA, 3-2-24 Toyosu,
Koto-ku, Tokyo 135-0061, Japan
www.renesas.com

Contact information

For further information on a product, technology, the most up-to-date version of a document, or your nearest sales office, please visit:
www.renesas.com/contact/.

Trademarks

Renesas and the Renesas logo are trademarks of Renesas Electronics Corporation. All trademarks and registered trademarks are the property of their respective owners.