

## ISL6539EVAL1

DDR Power Solution Using the ISL6539

AN1278  
Rev 0.00  
Oct 30, 2006

### Introduction

The ISL6539 is capable of providing a complete solution for the power requirements of DDRI, DDRII or DDRIII memory systems. The ISL6539 can be configured to operate as a dual switching regulator or as a DDR regulator. This application note will focus on the ISL6539 configured as a DDR regulator. For information on the ISL6539 configured as a dual switching regulator, refer to either the datasheet[1] or to application note AN1278.

As a DDR regulator, the ISL6539 provides control and protection for both the  $V_{DDQ}$  and  $V_{TT}$  rails while also providing  $V_{REF}$  for the DDR system. Both  $V_{DDQ}$  and  $V_{TT}$  are provided through synchronous buck regulation.  $V_{REF}$  is provided via a low current buffer.

The switching frequency is fixed at 300kHz for both the  $V_{DDQ}$  and  $V_{TT}$  regulators. The two channels can be phase shifted  $90^\circ$  in order to minimize interaction. The ISL6539 incorporates voltage-feed-forward ramp modulation, current mode control, and internal feedback compensation, which provides fast response to input voltage and output load transients.

Protection features include undervoltage and overvoltage protection as well as a programmable overcurrent protection feature that utilizes the  $r_{DS(ON)}$  of the lower MOSFET. A more complete description of the ISL6539 can be found in the datasheet.

### Quick Start Evaluation

The ISL6539EVAL1 board is shipped 'ready to use' right from the box. The box includes this application note, the ISL6539 datasheet, and the evaluation board.

The evaluation board supports testing with laboratory power supplies. Both regulated outputs can be exercised through external loads. There are posts available on the two regulated output rails for drawing a load and/or monitoring the voltages. An LED indicates the status of the PGOOD signal. There are also three scope probe points that allow for in depth analysis and two posts available to monitor the enable signals for either channel. Four jumpers have also been provided for control and monitoring purposes.

### Recommended Test Equipment

To test the full functionality of the ISL6539, the following equipment is recommended:

- Two laboratory power supplies
- Two Electronic Loads
- Four-channel Oscilloscope with probes
- Precision Digital Multimeters

### CIRCUIT SETUP

Refer to Figure 1 for locations of the jumpers, connectors and components described in the following sections.

### JUMPER SETTINGS

There are four jumpers on the board. Shunting jumper JP3 pulls the EN1 pin to VCC and is used to enable Channel 1, which is the  $V_{DDQ}$  regulator. Shunting jumper JP4 enables Channel 2, which is the  $V_{TT}$  regulator. It should be noted that the input rail for the  $V_{TT}$  regulator is the  $V_{DDQ}$  rail. If the  $V_{DDQ}$  rail is to be disabled and the  $V_{TT}$  rail enabled, then the  $V_{DDQ}$  rail must be energized from an external power supply and a  $0.01\mu\text{F}$  capacitor should be installed in location C21 for the  $V_{TT}$  rail to soft-start properly. C21 is the soft-start capacitor for the  $V_{TT}$  rail, as shown in the schematic.

Jumper JP1 can be used to monitor the ISL6539 bias current by connecting an ammeter to the two jumper pins. If the bias current is not being monitored, this jumper must be shunted.

Jumper JP5 is used to set the phase angle between the two switching regulators. Refer to Figure 1 for the jumper positions relating to the desired phase angle. Table 1 also provides a detailed description of the jumper descriptions and positions.

JUMPER	POSITION	FUNCTION
JP1	Shunted	An AmpMeter may be connected across these pins to measure IC and GATE Drive current
JP3	Shunted	CH1 enabled
	Removed	CH1 disabled
JP4	Shunted	CH2 enabled
	Removed	CH2 disabled
JP5	Toward VINPRG	This will tie VIN pin to the input voltage for feed forward. It will also program CH2 PWM to phase lag CH1 by $90^\circ$
	Away from VINPRG	This will tie VIN pin to GND, disabling input voltage feed forward, and will also program in phase PWM for CH1 and CH2

**TABLE 1. DETAILED DESCRIPTION OF THE JUMPER SETTINGS**

### CONNECTING LOADS

Loads should only be connected to the  $V_{DDQ}$  and  $V_{TT}$  rails.

*Loading  $V_{DDQ}$ :* Connect the positive terminal of an electronic load to the VDDQ post (J5). Connect the return terminal of the same load to the adjacent GND post (J7).

*Loading  $V_{TT}$  - Sourcing Current:* To test  $V_{TT}$  while the regulator sources current, connect the positive terminal of an electronic load to the VTT post (J6). Connect the return terminal of the same load to the adjacent GND post (J9).

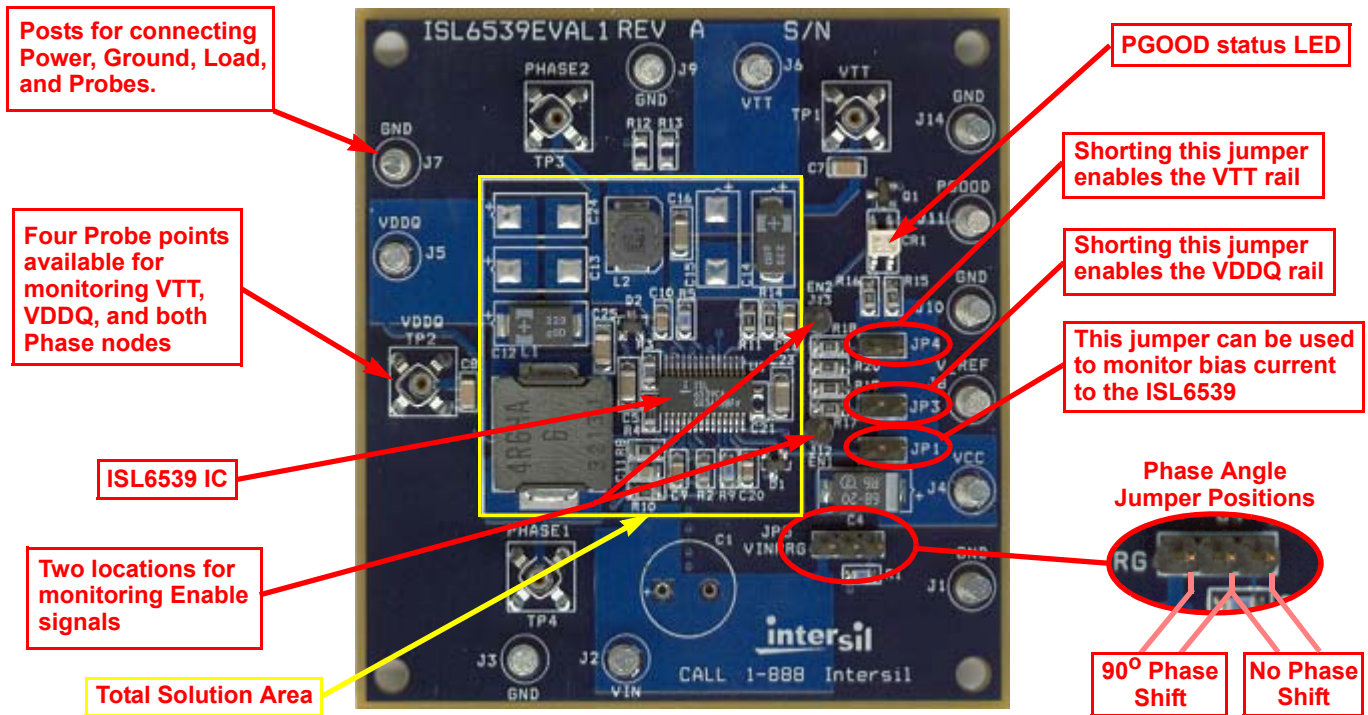

FIGURE 1. ISL6539EVAL1 BOARD

**Loading  $V_{TT}$  - Sinking Current:** To test  $V_{TT}$  while the regulator sinks current, connect the positive terminal of an electronic load to the VDDQ post (J5). Connect the return terminal of the same load to the VTT post (J6).

**CAUTION:** The return terminal of the load must float for this to work properly.

**CONNECTING PROBES**

The table below lists all the locations available for monitoring. The scope probe test points provide a low impedance ground connection and all GND post can be utilized as a ground connection for probes.

TYPE	VOLTAGE	LOCATION
POST	$V_{DDQ}$	J5
	$V_{TT}$	J6
	$V_{PGOOD}$	J11
	$V_{REF}$	J8
	$V_{CC}$	J4
	$V_{IN}$	J2
SCOPE PROBE TEST POINT	$V_{TT}$	TP1
	$V_{DDQ}$	TP2
	$V_{PHASE1}$	TP4
	$V_{PHASE2}$	TP3
TERMINAL	$V_{EN1}$	J12
	$V_{EN2}$	J13

TABLE 2. PROBE TYPES AND LOCATIONS

Terminals J12 (EN1) and J13 (EN2) may also be connected to a pulse generator for controlled ON/OFF operation of the respective regulators. However, make sure the signal generator for the enable voltage is no more than 5V and that the respective Enable jumper is removed.

**CONNECTING POWER**

Prior to connecting the power supplies to the evaluation board, the power supplies should either be turned off or the outputs should be disabled.

**$V_{CC}$  Power Connection:** Connect the positive terminal of a laboratory power supply to the VCC post (J4). Connect the return terminal of the same load to the adjacent GND post (J1).

**$V_{IN}$  Power Connection:** Connect the positive terminal of a laboratory power supply to the VIN post (J2). Connect the return terminal of the same load to the adjacent GND post (J3).

**Operation**

**APPLY POWER**

Prior to applying power, ensure that jumpers JP1 and JP5 are in the desired position, all loads are connected properly, and all probes are connected properly. Jumpers JP3 and JP4 can be shunted and removed after power has been applied.

The  $V_{IN}$  power supply must be turned on or enabled first. Likewise, it must always be disabled or turned off last. This supply can be set from a minimum of  $1.2V_{DDQ}$  to a maximum of 18V. After the  $V_{IN}$  power supply has been enabled, the VCC power supply may be enabled. The VCC power supply must be 5V.

The PGOOD status LED will give a visual indication of the  $V_{DDQ}$  regulator level. Table 3 describes the two states of the LED.

LED	CONDITION	RESULT
CR1	Green	$V_{OUT1}$ WITHIN PGOOD RANGE (89%-115% of nominal value)
	Red	$V_{OUT1}$ OUTSIDE PGOOD RANGE (89-115% of nominal value)

**TABLE 3. PGOOD STATUS LED CONDITION INDICATOR**

**EXAMINE WAVEFORMS**

Start-up is immediate following Power On Reset (POR). Using an oscilloscope or other laboratory equipment, the ramp-up and/or regulation of the outputs can be studied. Loading of the outputs can be accomplished through the use of electronic loads. Any other method, however, will work as well.

**Evaluation Board Design**

**General**

The evaluation board is built on a 2-ounce, four layer printed circuit board. The board is designed to support a continuous load of 5A on the  $V_{DDQ}$  rail and a simultaneous 3A continuous load on the  $V_{TT}$  rail while operating at room temperature and under natural convection cooling. Loading on  $V_{REF}$  should not exceed 10mA.

The schematic, bill of material, and the layout plots for the ISL6539EVAL1 evaluation board are provided at the end of this application note.

**Eval Board Performance**

**Power-Up**

When the  $V_{CC}$  voltage exceeds the POR level, the ISL6539 will begin the soft-start procedure. Figure 2 shows the start-up of both the  $V_{DDQ}$  and  $V_{TT}$  rails from POR.

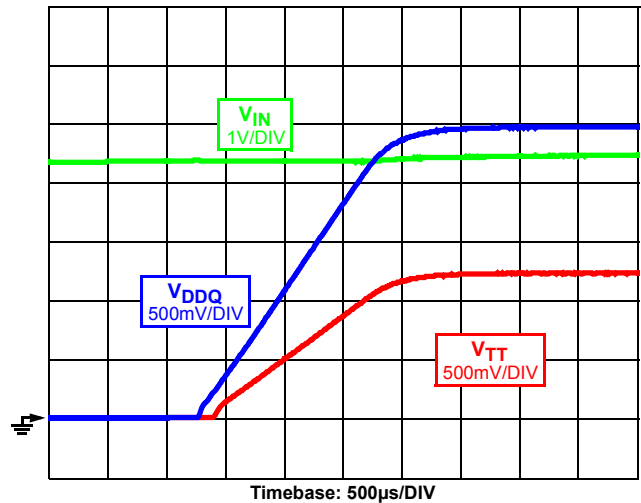

**FIGURE 2. POR SOFT-START, VCC = VIN**

Figure 3 shows the start up the  $V_{DDQ}$  and  $V_{TT}$  rails through the enabling of the  $V_{DDQ}$  regulator.

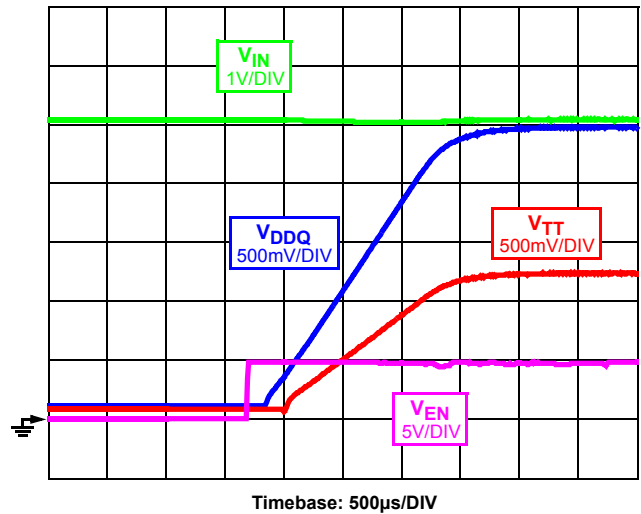

**FIGURE 3. ENABLED SOFT-START**

The ISL6539 is capable of starting into a prebiased output rail. Figure 4 shows the ISL6539 soft-starting both the  $V_{DDQ}$  and  $V_{TT}$  rails from POR with a prebias on the  $V_{DDQ}$  rail.

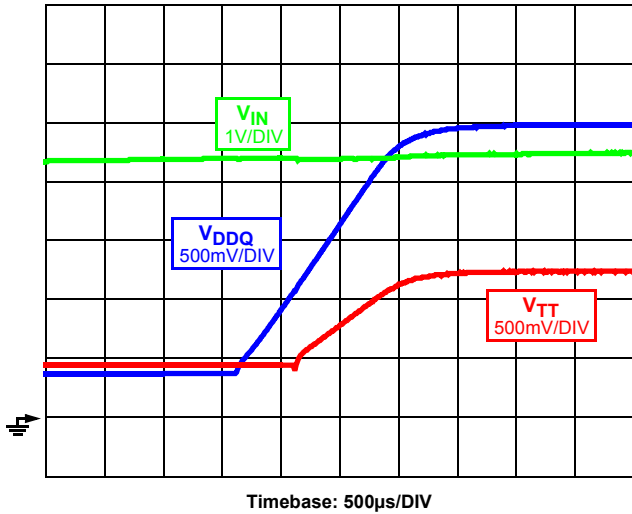

FIGURE 4. START-UP INTO PREBIASED OUTPUT

**Output Ripple**

Figure 5 shows the ripple on both the  $V_{DDQ}$  and  $V_{TT}$  rails with a  $90^\circ$  phase shift implemented between the two regulators.

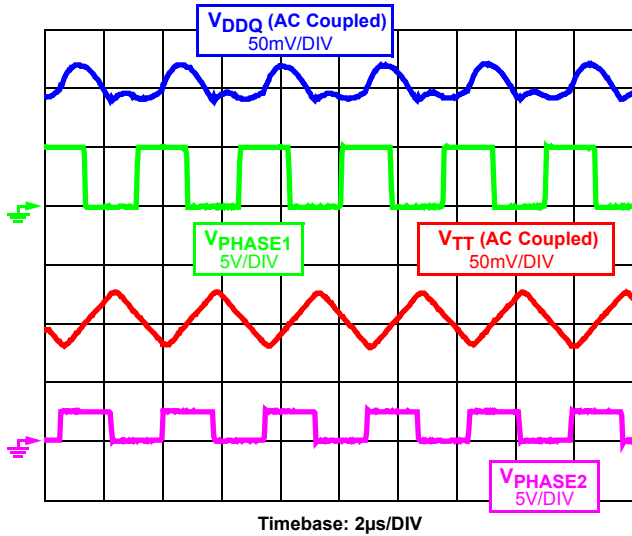

FIGURE 5. OUTPUT RIPPLE -  $90^\circ$  PHASE SHIFT

Figure 6 shows the ripple on both the  $V_{DDQ}$  and  $V_{TT}$  rails with a no phase shift implemented between the two regulators.

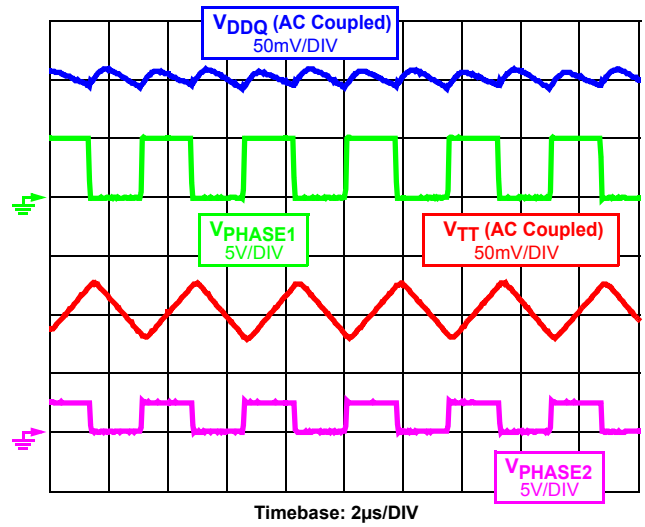

FIGURE 6. OUTPUT RIPPLE - NO PHASE SHIFT

**Transient Performance**

Figure 7 shows both the  $V_{DDQ}$  and  $V_{TT}$  rails while the  $V_{DDQ}$  rail is under transient loading.

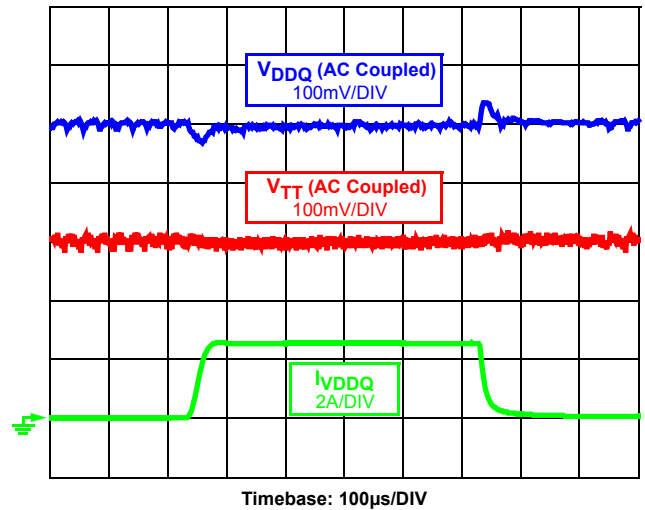

FIGURE 7. TRANSIENT LOAD ON  $V_{DDQ}$

Figure 8 shows both the  $V_{DDQ}$  and  $V_{TT}$  rails while the  $V_{TT}$  rail is experiencing a sourcing transient load.

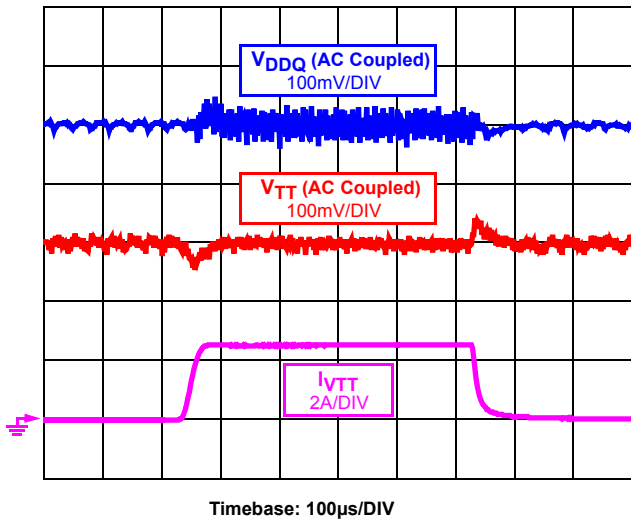

FIGURE 8. SOURCING TRANSIENT LOAD ON  $V_{TT}$

Figure 9 shows both the  $V_{DDQ}$  and  $V_{TT}$  rails while the  $V_{TT}$  rail is experiencing a sinking transient load.

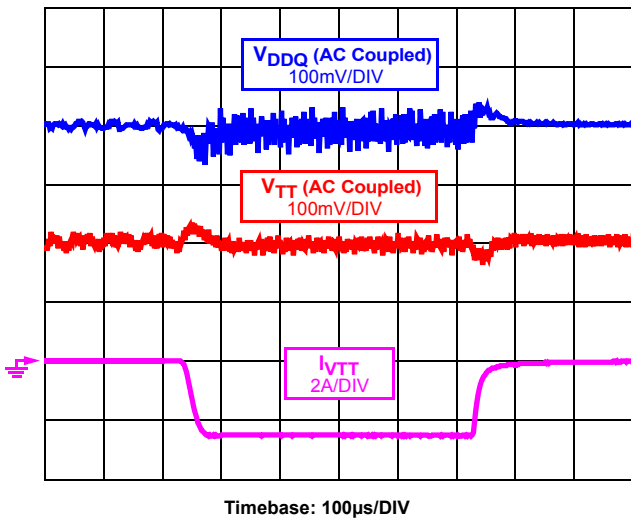

FIGURE 9. SINKING TRANSIENT LOAD ON  $V_{TT}$

**Efficiency**

Figure 10 shows the efficiency of the individual regulators. These efficiencies were measured while the complementary regulator was disabled.

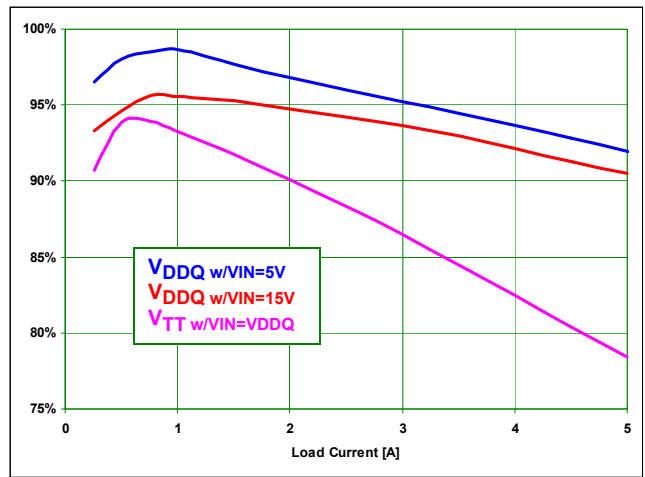

FIGURE 10. EFFICIENCY

## ISL6539EVAL1 Customization

There are numerous ways in which a designer might modify the ISL6539EVAL1 evaluation board for differing requirements. Some of the changes which are possible include:

- The output inductors, L1 and L2, for the  $V_{DDQ}$  and  $V_{TT}$  regulators, respectively.
- The input capacitance may be changed. The evaluation board is shipped with two 10 $\mu$ F ceramic capacitors, C2 and C3, as the input capacitance. A spot has been set aside for the installation of a 10mm diameter through hole aluminum electrolytic capacitor in location C1.
- The output capacitance of either regulator may be modified. The evaluation board is shipped with one 220 $\mu$ F capacitor on the output of each regulator. There are two empty locations, C13 and C24, available for the  $V_{DDQ}$  regulator and one empty location, C15, available for the  $V_{TT}$  regulator.
- The overcurrent trip point of the  $V_{DDQ}$  regulator, programmed through the OCSET resistor, R9. Refer to the ISL6539 datasheet for details on this.
- Changing the value of C20 will alter the rise time of the outputs during soft-start. Refer to the ISL6539 datasheet for details on this.
- The load capacity for either rail can be increased by exchanging the MOSFETs, U2 and U3, for ones with higher current handling capabilities. The ISEN resistor values, R4 and R5, may need to be modified if this is done. The overcurrent resistor value, R9, would also have to be reviewed. Refer to the ISL6539 datasheet for details on calculating the values of these resistors.
- The output voltage of the  $V_{DDQ}$  regulator may be modified by changing resistor R10. Refer to the ISL6539 datasheet for details on this.
- The percentage at which the  $V_{TT}$  rail and the  $V_{REF}$  voltage track the  $V_{DDQ}$  rail can be modified by altering the resistor divider set up by resistors R11 and R14.

## Conclusion

The ISL6539EVAL1 is a versatile platform that allows designers to gain a full understanding of the functionality of the ISL6539 in a DDR memory system. The board is also flexible enough to allow the designer to modify the board for differing requirements. The following pages provide a schematic, bill of materials, and layout drawings to support implementation of this solution.

## References

For Intersil documents available on the web, see <http://www.intersil.com/>

- [1] *ISL6539 Data Sheet*, Intersil Corporation, File No. FN9144.

**ISL6539EVAL1 Schematic**

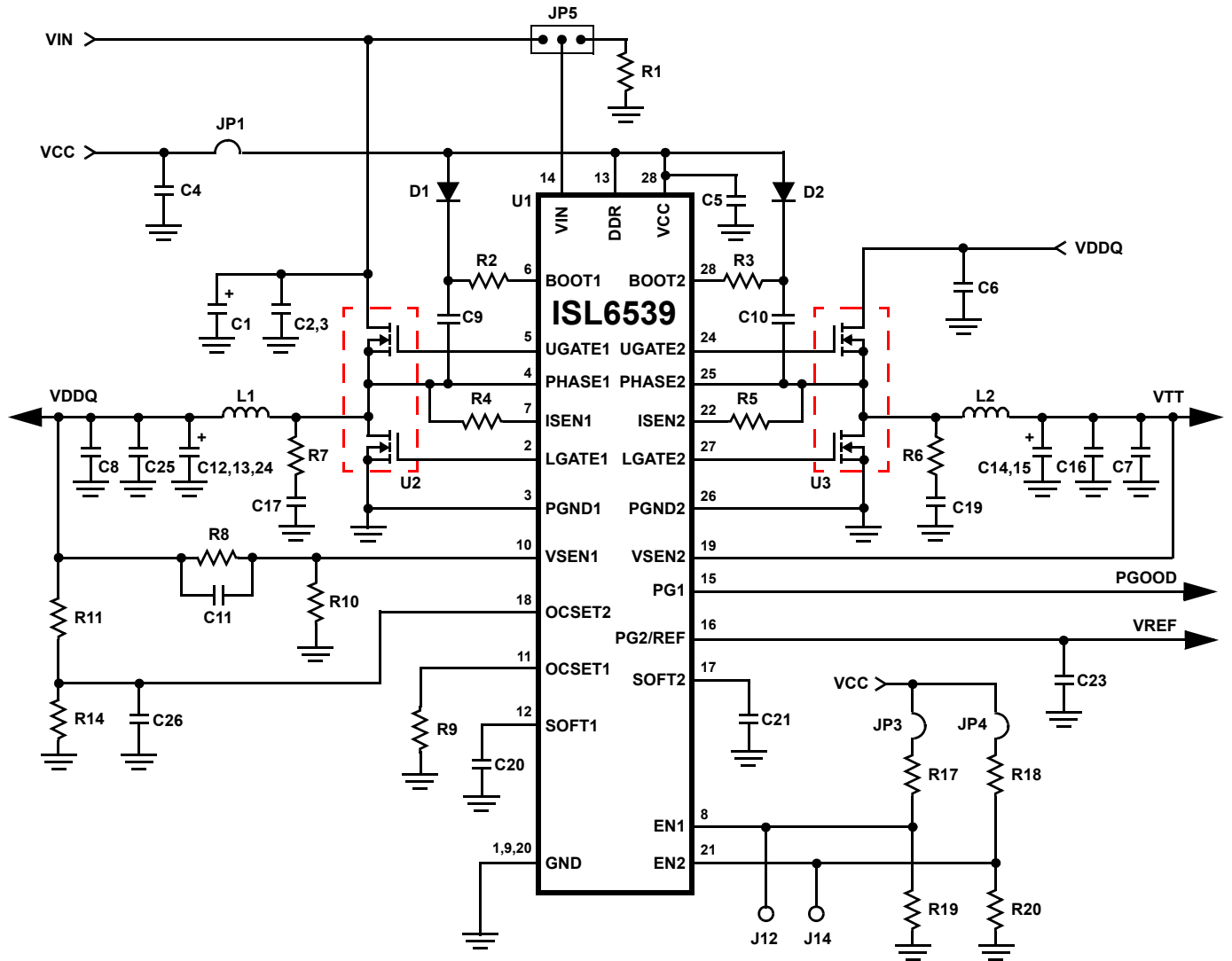

**ISL6539EVAL1 Bill of Materials (BOM)**

QTY	REFERENCE	DESCRIPTION	VENDOR	MFG. PART NO.
2	C20, C26	CAPACITOR, SMD, 0805, 0.01 $\mu$ F, 50V, 10%, X7R	PANASONIC	ECJ-2VB1H103K
1	C11	CAPACITOR, SMD, 0805, 0.015 $\mu$ F, 50V, 10%, X7R	PANASONIC	ECU-V1H153K
2	C9, C10	CAPACITOR, SMD, 0805, 0.15 $\mu$ F, 25V, 10%, X7R	PANASONIC	ECJ-2YB1E154kK
2	C7, C8	CAPACITOR, SMD, 1206, 1 $\mu$ F, 10V, 10%, X7R	VENKEL	C1206X7R100-105KNE
5	C5, C6, C16, C23, C25	CAPACITOR, SMD, 1206, 4.7 $\mu$ F, 10V, 10%, X7R	VENKEL	C1206X7R100475KNE
3	C12, C13, C14, C24	CAP TANT, LOW ESR, SMD, D3, 220 $\mu$ F, 4V, 20%	SANYO	4TPC220M
1	C4	CAP TANT, LOW ESR, SMD, D, 68 $\mu$ F, 16V, 10%	KEMET	T494D686K016AS
2	C2, C3	CAPACITOR, SMD, 1812, 10 $\mu$ F, 25V, 20%, X5R	TAIYO YUDEN	TMK432BJ106MM-T
2	D1, D2	DIODE-SCHOTTKYBARR, SMD, SOT323, 3P, 30V, 0.2A	ON-SEMICONDUCTOR	BAT54WT1-T
1	CR1	LED, SMD, 4P, OTHER, POLARIZED RED/GRN	LUMEX	SSL-LXA3025IGC-TR
1	L1	PWR CHOKE COIL, SMD, 5.7mm, 4.6 $\mu$ H, 25%	PANASONIC	ETQ-P6F4R6HFA
1	L2	PWR CHOKE COIL, SMD, 6x6x3mm, 1.5 $\mu$ H, 20% 3.2A	PANASONIC	ELL6SH1R5M
1	U1	IC-DUAL SWITCHER 30V, 28P, QSOP	INTERSIL	ISL6539CA
1	Q1	TRANSISTOR, N-CHANNEL, 3P, SOT23	ON-SEMICONDUCTOR	BSS123LT1-T
2	U2, U3	TRANSISTOR - DUAL MOS, N-CHANNEL, 8P, SOIC, 30V	FAIRCHILD	FDS6912A
2	R2, R3	RESISTOR, SMD, 0805, 0 $\Omega$ , 1/10W, TF	PANASONIC	ERJ-6GEY0R00V
1	R5	RESISTOR, SMD, 0805, 1k, 1/10W, 1%, TF	PANASONIC	ERJ-6ENF1001
5	R10, R11, R14, R19, R20	RESISTOR, SMD, 0805, 10k, 1/10W, 1%, TF	PANASONIC	ERJ-6ENF1002V
2	R1, R9	RESISTOR, SMD, 0805, 100k, 1/10W, 1%, TF	PANASONIC	ERJ-6ENF1003V
1	R8	RESISTOR, SMD, 0805, 17.8k, 1/10W, 1%, TF	PANASONIC	ERJ-J6ENF1782V
1	R4	RESISTOR, SMD, 0805, 2.49k, 1/10W, 1%, TF	PANASONIC	ERJ-6ENF2491
4	R15 - R18	RESISTOR, SMD, 0805, 680 $\Omega$ , 1/10W, 5%, TF	PANASONIC	ERJ-6GEYJ681V



ISL6539EVAL1 Printed Circuit Board Layers

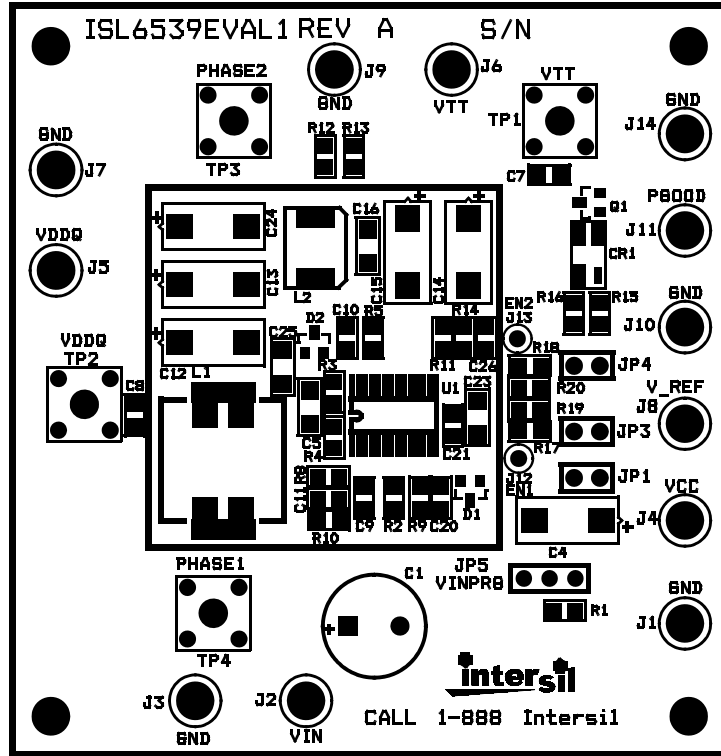

ISL6539EVAL1 - TOP SILK SCREEN

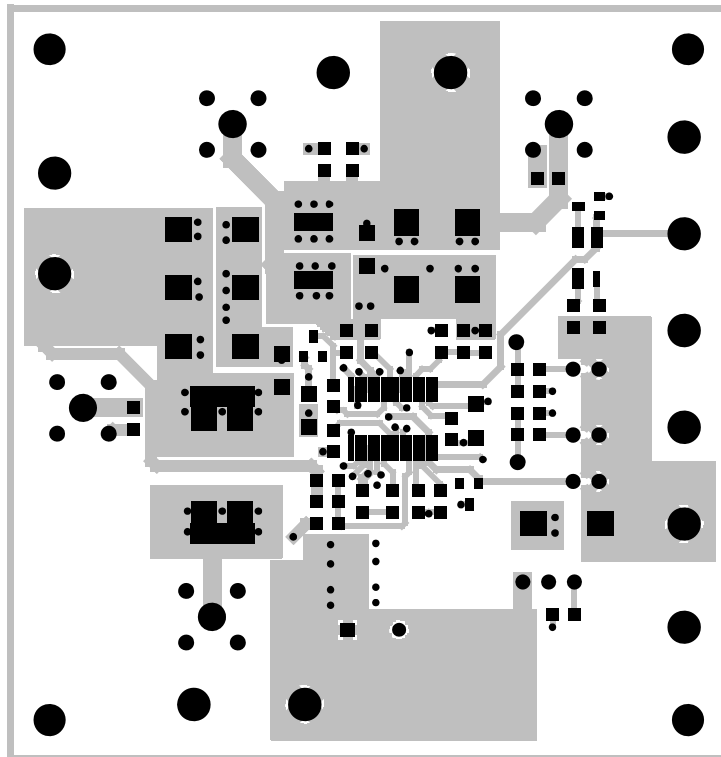

ISL6539EVAL1 - TOP LAYER

**ISL6539EVAL1 Printed Circuit Board Layers** (Continued)

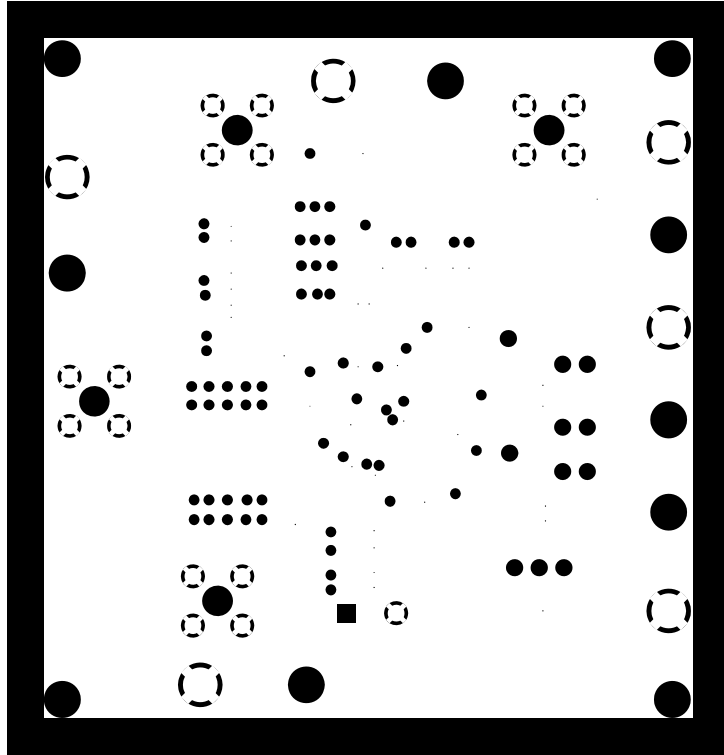

ISL6539EVAL1 - INTERNAL 1 - GROUND

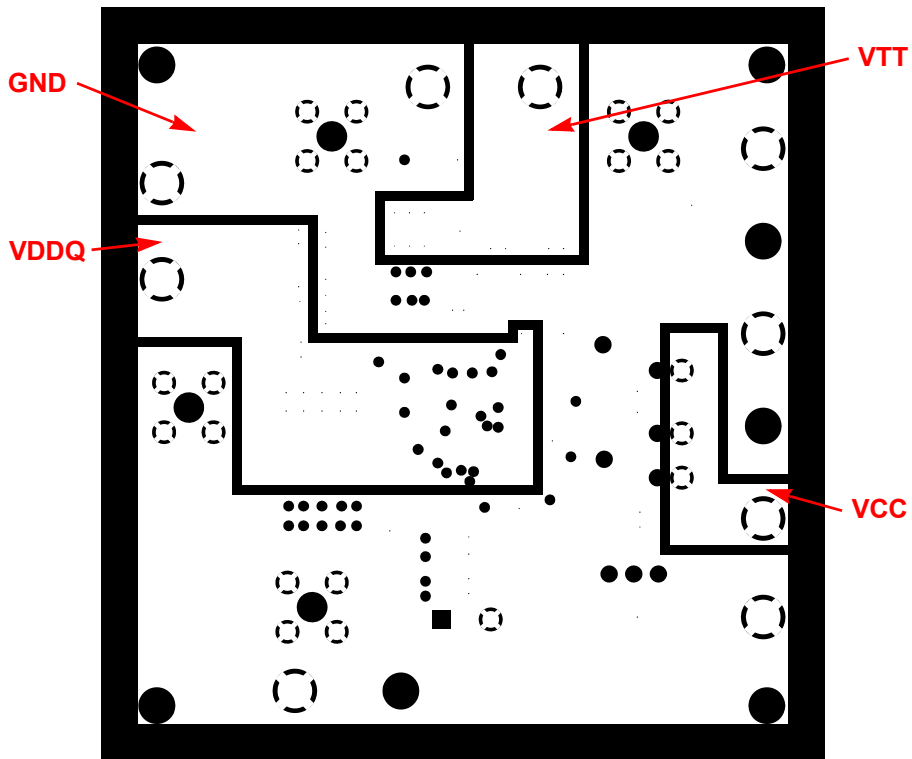

ISL6539EVAL1 - INTERNAL 2 - POWER

**ISL6539EVAL1 Printed Circuit Board Layers** (Continued)

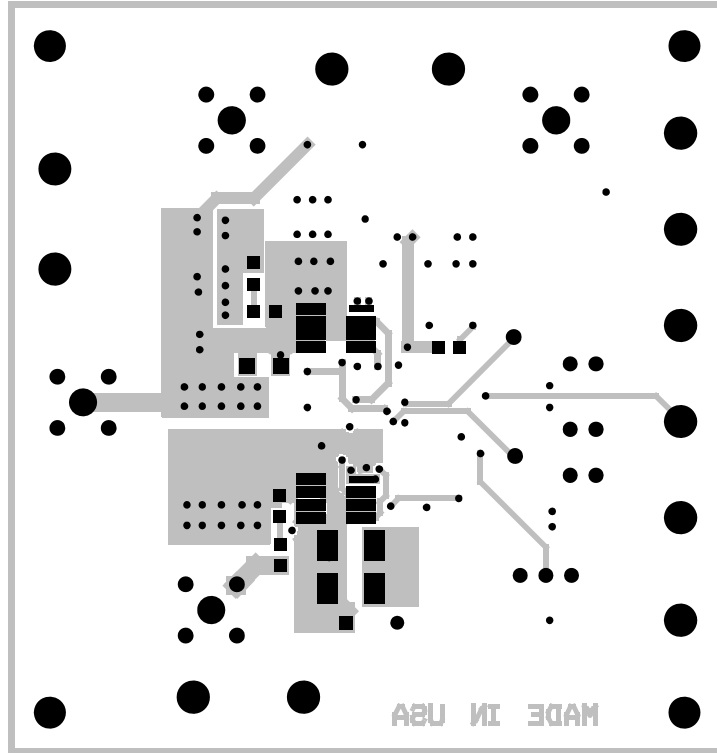

ISL6539EVAL1 - BOTTOM LAYER

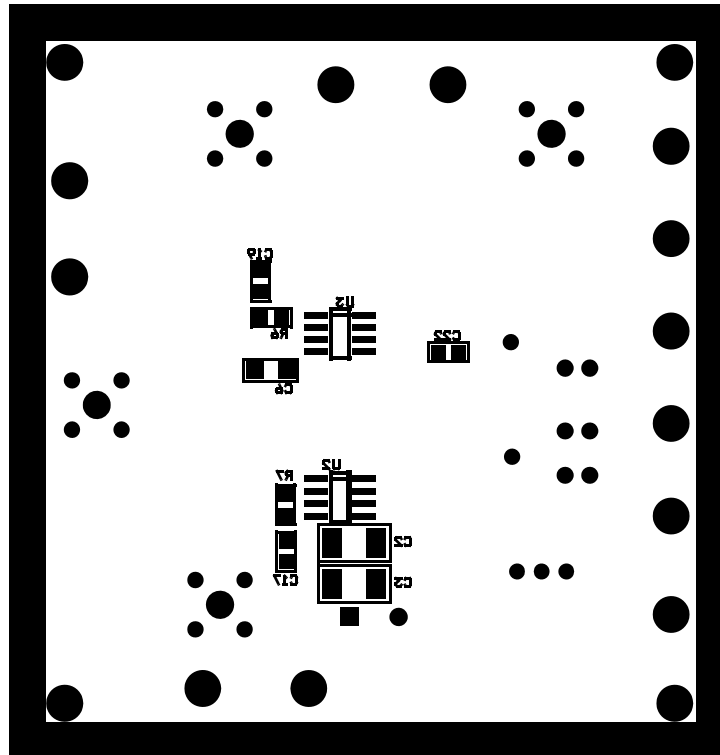

ISL6539EVAL1 - BOTTOM SILK SCREEN

## Notice

1. Descriptions of circuits, software and other related information in this document are provided only to illustrate the operation of semiconductor products and application examples. You are fully responsible for the incorporation or any other use of the circuits, software, and information in the design of your product or system. Renesas Electronics disclaims any and all liability for any losses and damages incurred by you or third parties arising from the use of these circuits, software, or information.
  2. Renesas Electronics hereby expressly disclaims any warranties against and liability for infringement or any other claims involving patents, copyrights, or other intellectual property rights of third parties, by or arising from the use of Renesas Electronics products or technical information described in this document, including but not limited to, the product data, drawings, charts, programs, algorithms, and application examples.
  3. No license, express, implied or otherwise, is granted hereby under any patents, copyrights or other intellectual property rights of Renesas Electronics or others.
  4. You shall not alter, modify, copy, or reverse engineer any Renesas Electronics product, whether in whole or in part. Renesas Electronics disclaims any and all liability for any losses or damages incurred by you or third parties arising from such alteration, modification, copying or reverse engineering.
  5. Renesas Electronics products are classified according to the following two quality grades: "Standard" and "High Quality". The intended applications for each Renesas Electronics product depends on the product's quality grade, as indicated below.  
"Standard": Computers; office equipment; communications equipment; test and measurement equipment; audio and visual equipment; home electronic appliances; machine tools; personal electronic equipment; industrial robots; etc.  
"High Quality": Transportation equipment (automobiles, trains, ships, etc.); traffic control (traffic lights); large-scale communication equipment; key financial terminal systems; safety control equipment; etc.  
Unless expressly designated as a high reliability product or a product for harsh environments in a Renesas Electronics data sheet or other Renesas Electronics document, Renesas Electronics products are not intended or authorized for use in products or systems that may pose a direct threat to human life or bodily injury (artificial life support devices or systems; surgical implantations; etc.), or may cause serious property damage (space system; undersea repeaters; nuclear power control systems; aircraft control systems; key plant systems; military equipment; etc.). Renesas Electronics disclaims any and all liability for any damages or losses incurred by you or any third parties arising from the use of any Renesas Electronics product that is inconsistent with any Renesas Electronics data sheet, user's manual or other Renesas Electronics document.
  6. When using Renesas Electronics products, refer to the latest product information (data sheets, user's manuals, application notes, "General Notes for Handling and Using Semiconductor Devices" in the reliability handbook, etc.), and ensure that usage conditions are within the ranges specified by Renesas Electronics with respect to maximum ratings, operating power supply voltage range, heat dissipation characteristics, installation, etc. Renesas Electronics disclaims any and all liability for any malfunctions, failure or accident arising out of the use of Renesas Electronics products outside of such specified ranges.
  7. Although Renesas Electronics endeavors to improve the quality and reliability of Renesas Electronics products, semiconductor products have specific characteristics, such as the occurrence of failure at a certain rate and malfunctions under certain use conditions. Unless designated as a high reliability product or a product for harsh environments in a Renesas Electronics data sheet or other Renesas Electronics document, Renesas Electronics products are not subject to radiation resistance design. You are responsible for implementing safety measures to guard against the possibility of bodily injury, injury or damage caused by fire, and/or danger to the public in the event of a failure or malfunction of Renesas Electronics products, such as safety design for hardware and software, including but not limited to redundancy, fire control and malfunction prevention, appropriate treatment for aging degradation or any other appropriate measures. Because the evaluation of microcomputer software alone is very difficult and impractical, you are responsible for evaluating the safety of the final products or systems manufactured by you.
  8. Please contact a Renesas Electronics sales office for details as to environmental matters such as the environmental compatibility of each Renesas Electronics product. You are responsible for carefully and sufficiently investigating applicable laws and regulations that regulate the inclusion or use of controlled substances, including without limitation, the EU RoHS Directive, and using Renesas Electronics products in compliance with all these applicable laws and regulations. Renesas Electronics disclaims any and all liability for damages or losses occurring as a result of your noncompliance with applicable laws and regulations.
  9. Renesas Electronics products and technologies shall not be used for or incorporated into any products or systems whose manufacture, use, or sale is prohibited under any applicable domestic or foreign laws or regulations. You shall comply with any applicable export control laws and regulations promulgated and administered by the governments of any countries asserting jurisdiction over the parties or transactions.
  10. It is the responsibility of the buyer or distributor of Renesas Electronics products, or any other party who distributes, disposes of, or otherwise sells or transfers the product to a third party, to notify such third party in advance of the contents and conditions set forth in this document.
  11. This document shall not be reprinted, reproduced or duplicated in any form, in whole or in part, without prior written consent of Renesas Electronics.
  12. Please contact a Renesas Electronics sales office if you have any questions regarding the information contained in this document or Renesas Electronics products.
- (Note 1) "Renesas Electronics" as used in this document means Renesas Electronics Corporation and also includes its directly or indirectly controlled subsidiaries.  
(Note 2) "Renesas Electronics product(s)" means any product developed or manufactured by or for Renesas Electronics.

(Rev.4.0-1 November 2017)



### SALES OFFICES

Renesas Electronics Corporation

<http://www.renesas.com>

Refer to "<http://www.renesas.com/>" for the latest and detailed information.

**Renesas Electronics America Inc.**  
1001 Murphy Ranch Road, Milpitas, CA 95035, U.S.A.  
Tel: +1-408-432-8888, Fax: +1-408-434-5351

**Renesas Electronics Canada Limited**  
9251 Yonge Street, Suite 8309 Richmond Hill, Ontario Canada L4C 9T3  
Tel: +1-905-237-2004

**Renesas Electronics Europe Limited**  
Dukes Meadow, Millboard Road, Bourne End, Buckinghamshire, SL8 5FH, U.K  
Tel: +44-1628-651-700, Fax: +44-1628-651-804

**Renesas Electronics Europe GmbH**  
Arcadiastrasse 10, 40472 Düsseldorf, Germany  
Tel: +49-211-6503-0, Fax: +49-211-6503-1327

**Renesas Electronics (China) Co., Ltd.**  
Room 1709 Quantum Plaza, No.27 ZhichunLu, Haidian District, Beijing, 100191 P. R. China  
Tel: +86-10-8235-1155, Fax: +86-10-8235-7679

**Renesas Electronics (Shanghai) Co., Ltd.**  
Unit 301, Tower A, Central Towers, 555 Langao Road, Putuo District, Shanghai, 200333 P. R. China  
Tel: +86-21-2226-0888, Fax: +86-21-2226-0999

**Renesas Electronics Hong Kong Limited**  
Unit 1601-1611, 16/F., Tower 2, Grand Century Place, 193 Prince Edward Road West, Mongkok, Kowloon, Hong Kong  
Tel: +852-2265-6688, Fax: +852-2886-9022

**Renesas Electronics Taiwan Co., Ltd.**  
13F, No. 363, Fu Shing North Road, Taipei 10543, Taiwan  
Tel: +886-2-8175-9600, Fax: +886-2-8175-9670

**Renesas Electronics Singapore Pte. Ltd.**  
80 Bendemeer Road, Unit #06-02 Hyflux Innovation Centre, Singapore 339949  
Tel: +65-6213-0200, Fax: +65-6213-0300

**Renesas Electronics Malaysia Sdn.Bhd.**  
Unit 1207, Block B, Menara Amcorp, Amcorp Trade Centre, No. 18, Jln Persiaran Barat, 46050 Petaling Jaya, Selangor Darul Ehsan, Malaysia  
Tel: +60-3-7955-9390, Fax: +60-3-7955-9510

**Renesas Electronics India Pvt. Ltd.**  
No.777C, 100 Feet Road, HAL 2nd Stage, Indiranagar, Bangalore 560 038, India  
Tel: +91-80-67208700, Fax: +91-80-67208777

**Renesas Electronics Korea Co., Ltd.**  
17F, KAMCO Yangjae Tower, 262, Gangnam-daero, Gangnam-gu, Seoul, 06265 Korea  
Tel: +82-2-558-3737, Fax: +82-2-558-5338