

## ISL68201-99140DEMO1Z

### Demonstration Board User Guide

UG068  
Rev 0.00  
March 10, 2016

The [ISL68201](#) is a single-phase synchronous buck PWM controller featuring Intersil's proprietary R4™ Technology, which has extremely fast transient performance, accurately regulated frequency control and all internal compensation. The ISL68201 supports a wide 4.5V to 24V input voltage range and a wide 0.5V to 5.5V output range. It includes programmable functions and telemetries for easy use and high system flexibility using SMBus, PMBus, or I<sup>2</sup>C interface. See the [ISL68201](#) datasheet for more details.

The [ISL99140](#) is a high performance DrMOS power stage designed for high frequency power conversion. By combining a high performance FET driver and MOSFETs in an advanced package, high density DC/DC converters may be created.

The ISL68201-99140DEMO1Z is a 6-layer board demonstrating a compact 17mmx17mm 35A synchronous buck converter. Transient performance, fault protections, DC/AC regulations, PMBus programming, power sequencing, margining and other features can be evaluated using this board.

The PMBus dongle (ZLUSBEVAL3Z), i.e., USB-to-PMBus™ adapter, and USB cable are included in the demonstration kit. Intersil's PowerNavigator™ evaluation software can be installed from Intersil's website and evaluate the full PMBus functionality of the part using a PC running Microsoft Windows 7 or 8.

## References

- [ISL68201](#) datasheet
- [AN1900](#), "USB to PMBus™ Adapter"
- Intersil's [PowerNavigator™](#) User Guide

## Key Features

- 35A synchronous buck converter with PMBus control
- On-board transient load with adjustable di/dt
- Configurable through resistor pins
- Cascadable PMBus connectors
- Integrated LDOs for single rail solution
- Enable switch and power-good indicator
- All ceramics solution with SP capacitor footprint option

## Target Specifications

- V<sub>IN</sub> = 4.75V to 14.5V
- V<sub>OUT</sub> = 1V/35A full load
- f<sub>SW</sub> = 400kHz
- Peak efficiency:
  - 88.3% at 15A/1V<sub>OUT</sub>/12V<sub>IN</sub>
  - 94.5% at 10A/2.5V<sub>OUT</sub>/5V<sub>IN</sub>
- Output regulation: 1V ±8mV
- I/O capacitor rating: C<sub>IN</sub> - 16V; C<sub>OUT</sub> - 4V
- Compact size: 17mmx17mm
- With or without PMBus/SMBus/I<sup>2</sup>C capability

## Ordering Information

PART NUMBER	DESCRIPTION
ISL68201-99140DEMO1Z	ISL68201-99140 demonstration kit (demonstration board, dongle, USB cable)

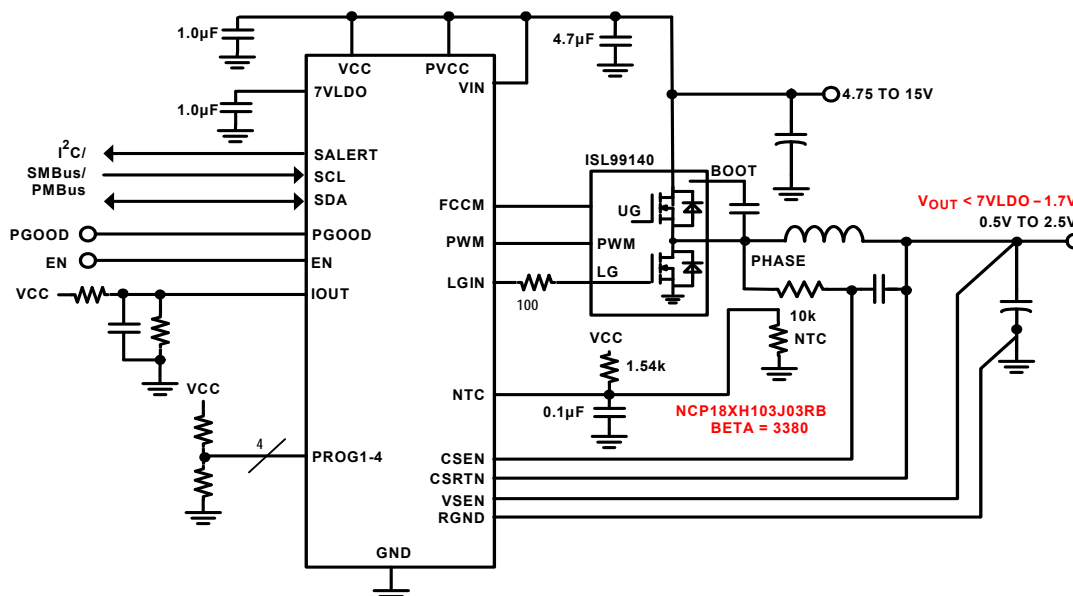

FIGURE 1. ISL68201-99140DEMO1Z SIMPLIFIED SCHEMATIC

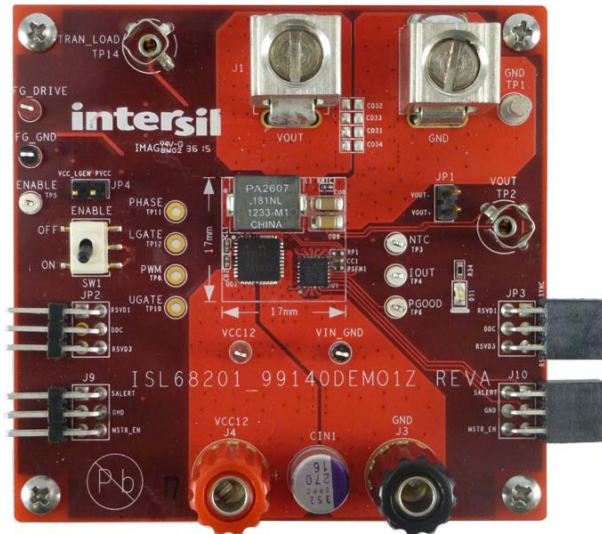

FIGURE 2. DEMONSTRATION BOARD TOP VIEW

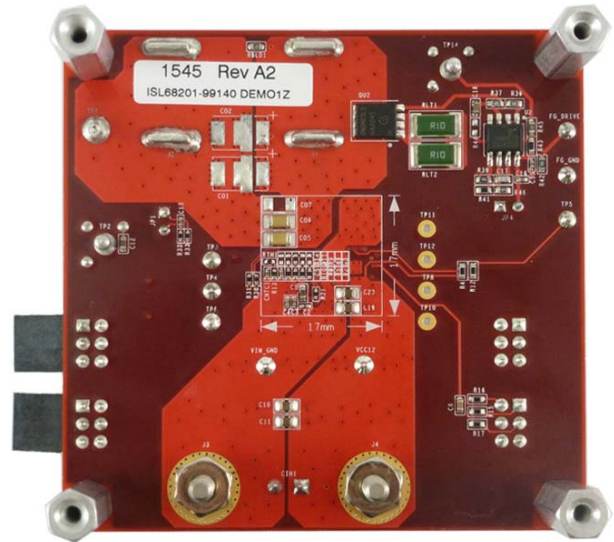

FIGURE 3. DEMONSTRATION BOARD BOTTOM VIEW

## Demonstration Board Description

The ISL68201-99140DEMO1Z provides all circuitry required to demonstrate the key features of the ISL68201. A majority of the features of the ISL68201, such as optimal transient response with Intersil's R4™ Modulator, 8-bit programmable boot voltage levels, selectable switching frequency in continuous conduction mode, selectable PFM operation option for improved light-load efficiency, power-good monitor for soft-start and fault detection, over-temperature protection, output overcurrent and short-circuit protection, and output overvoltage protection are available on this demonstration board.

[Figure 1](#) shows a simplified schematic diagram of the ISL68201-99140DEMO1Z board. [Figure 6](#) shows the detailed 35A buck solution schematics, while [Figure 7](#) shows the I/O connectors, auxiliary circuits and on-board transient circuits. [Figures 8](#) through [30](#) show typical performance data and [Figures 31](#) through [38](#) show the PCB board layout. The default programming pins setting is given on the upper right corner of [Figure 6](#) and the Bill of Materials (BOM) is included for reference beginning on [page 9](#).

The ISL68201-99140DEMO1Z board can run by itself without a series bus communication. The operational configuration is fully programmable via the programming pins (PROG1-4).

The ISL68201 however, utilizes the PMBus/SMBus/I<sup>2</sup>C protocol and provides the flexibility for digital power management and performance optimization prior to finalizing the hardware configuration on the programming pins.

The buck regulator in the ISL68201-99140DEMO1Z board is a single input rail design, i.e., everything is biased by the input supply (typically 12V). The resistor divider on the EN pin ( $R_4$  and  $R_{12}$ ) can set the input supply undervoltage protection level and its hysteresis. The “ENABLE” switch is a hardware operational control, alternately, the series bus ON\_OFF\_CONFIG and OPERATION commands can be used for software operational control.

Furthermore, an on-board transient load, as shown on [Figure 4](#), with di/dt and load step amplitude is controlled by a function generator. Since this auxiliary circuit draws more than 10mA current, the jumper on JP5 should be removed for accurate efficiency measurement.

Intersil's PowerNavigator™ evaluation software is compatible with Windows XP, 7 or 8 operating systems and can be used to evaluate the series bus functionality of the ISL68201. The software and user guide can be found on following Intersil website: <http://www.intersil.com/powernavigator>.

## Quick Start Guide

### Stand-Alone Operation

1. Set ENABLE switch to “OFF” position.
2. Connect a power supply (off) to input connectors (J4-VIN and J2-GND).
3. Set input power supply voltage level (no more than 15V) and current limiting (no more than 1A for 0A load).
4. Turn the power supply on.
5. Set ENABLE switch to “ON” position.
6. Increase power supply current limit enough to support more than the full load.
7. Apply load to output connectors (J1-VOUT and J2-SGND).
8. Monitor operation using an oscilloscope.

### PMBus Operation

1. Connect supplied Intersil's dongle to J9.
2. Connect supplied USB cable from computer to the dongle.
3. After the input supply powers up, open the PowerNavigator evaluation software.
4. Select detected ISL68201 device (Address - 60h) and follow Intersil's PowerNavigator™ user guide.
5. Monitor and configure the board using PMBus commands in the evaluation software.

## Configuration

The default programming pin settings of the ISL68201-99140DEMO1Z board can be found at the resistor reader table on the upper right corner of ["ISL68201-99140DEMO1Z Schematics" on page 7](#) or read back via Intersil's [PowerNavigator™](#) software. Each PMBus command can be loaded or programmed via the PowerNavigator™ software. Note that ISL68201 does not have NVM to store the operational configuration however, it can be set by the resistor programming pins (PROG1-4) or programmed by the series bus master before powering up. If a series bus master is available in the system, the ISL68201-based rail can be fully controlled via software for the power-up/power-down sequencing and operational configuration without a soldering iron.

## Load Transient

The on-board transient load can be controlled by a function generator, whose inputs are connected to FG\_DRIVE2 and FG\_GND2. The function generator's output is terminated by R<sub>42</sub> at the input terminal, while its amplitude and dV/dt set the load amplitude and di/dt on the 50mΩ load (R<sub>LT1</sub>/R<sub>LT2</sub>). The transient load can be monitored with a scope probe on TP15. Note that the duty cycle of applied load should be less than 10% duty cycle with <10ms pulse width to keep the average power of R<sub>LT1</sub>/R<sub>LT2</sub> less than its power rating.

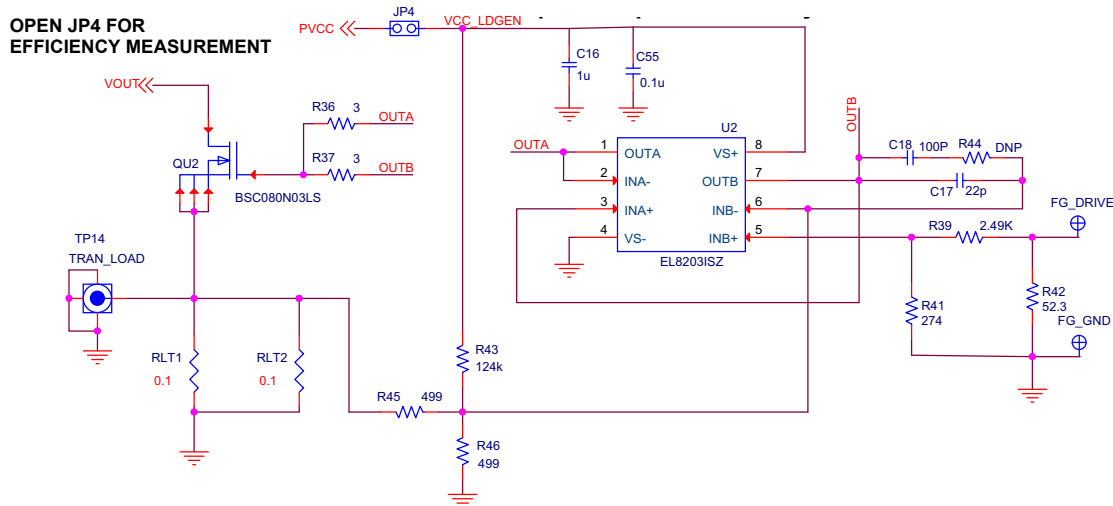

FIGURE 4. ON-BOARD LOAD TRANSIENT



FIGURE 5. ISL68201-99140DEMO1Z DEMONSTRATION KIT SET-UP

## Design Modifications

When modifying the design, it will require a new set of L/DCR matching for different inductor, divider on the PROG pins for different operational configuration,  $R_{SEN1}$  for OCP, and  $I_{OUT}$  network for accurate digital  $I_{OUT}$ ; higher input capacitor rating to support higher than 16V input, higher output capacitor rating to support higher than 4V output. Refer to [ISL68201](#) datasheet and [PowerNavigator™](#) software for proper design modifications including L/DCR matching, thermal compensation, OCP and digital  $I_{OUT}$  fine tuning.

Two examples are provided in [Table 1](#), showing the recommended design modifications to accommodate the

application cases with 5V and 3.3V output voltages. Some fine tuning might be needed depending upon the rework and final layout design.

For the 5V input voltage applications with  $4.5V < V_{IN} < 5.5V$  requirement, the “VIN”, “VCC”, “PVCC” and “7VLD0” pins should be shorted together, to connect with the input supply for optimal performance;  $R_{12}$  should be removed as well.

Note that all devices in the same bus should set different addresses for unique identification and proper communication. JP2, 3, 9 and 10 connectors are designed to cascade many Intersil's solutions for easy communication and system evaluation prior to the system integration and design.

TABLE 1. DESIGN EXAMPLES

REFERENCE DESIGNATOR	5.0V AT 16A	3.3V AT 16A	3.3V AT 30A	COMMENTS
L1	680nH, 1.72mΩ Vendor: Würth Electronic; Part Number: 744334006		470nH, 0.165mΩ Vendor: Würth Electronic; Part Number: 744309047	Reduce Output ripple current; typically higher voltage output needs higher inductance.
C05, C06, C08, C09	100μF/X5R/6.3V/1206 Vendor: Murata; Part Number: GRM21BR60J107ME11			Increase $C_{OUT}$ rating to support higher $V_{OUT}$ . Also capacitance of ceramic capacitors decreases with increased output voltage.
PROG1 (DC)	DFh	BFh	BFh	Set correct $V_{BOOT} = V_{OUT}$
R3	147k, 1%	105k, 1%	105k, 1%	
PROG2 (DD)	A0h	BFh	BFh	Set Different PMBus Addresses as needed TCOMP = 15 PFM DISABLED
R5	105k, 1%	DNP	DNP	
R6	DNP	105k, 1%	105k, 1%	
PROG3 (DE)	0Dh	0Dh	0Dh	Set AV = 13 $f_{sw} = 500kHz$ OCP = Retry 25kHz Clamp Disabled
R8	24.3k, 1%	24.3k, 1%	24.3k, 1%	
R9	16.9k, 1%	16.9k, 1%	16.9k, 1%	
PROG4 (DF)	08h	08h	08h	Set RR = 400k SS = 1.25mV/μs AVMLTI = 1x
R10	15k, 1%	15k, 1%	15k, 1%	
R11	29.4k, 1%	29.4k, 1%	29.4k, 1%	
RP1	4.99k, 1%	4.99k, 1%	3.57k, 1%	L/DCR Matching
$R_{SEN1}$	536, 1%	536, 1%	62, 1%	Set OCP
R13	11k, 1%	11k, 1%	15k, 1%	Set $I_{OUT}$ to 1A/1A Slope
R14	TBD	TBD	TBD	Pull-up value depends upon final layout design

NOTE: Some fine tuning might be needed depending upon the rework and final layout design.

## Design and Layout Considerations

To ensure a first pass design, the schematics design must be done correctly and the board must be carefully laid out.

As a general rule, power layers should be close together, either on the top or bottom of the board, with the weak analog or logic signal layers on the opposite side of the board or internal layers. The ground-plane layer should be in between the power layers and the signal layers to provide shielding. Often, the layer below the top and the layer above the bottom should be the ground layers.

There are two sets of components in a DC/DC converter, the power components and the small signal components. The power components are the most critical because they switch large amount of energy. The small signal components connect to sensitive nodes or supply critical bypassing current and signal coupling.

The power components should be placed first and these include MOSFETs, input and output capacitors and the inductor. Keeping the distance between the power train and the control IC short helps keep the gate drive traces short. These drive signals include the LGATE, UGATE, GND, PHASE and BOOT.

When placing MOSFETs, try to keep the source of the upper MOSFETs and the drain of the lower MOSFETs as close as thermally possible. Input high frequency capacitors should be placed close to the drain of the upper MOSFETs and the source of the lower MOSFETs. Place the output inductor and output capacitors between the MOSFETs and the load. High frequency output decoupling capacitors (ceramic) should be placed as close as possible to the decoupling target, making use of the shortest connection paths to any internal planes. Place the components in such a way that the area under the IC has less noise traces with high  $dV/dt$  and  $di/dt$ , such as gate signals, phase node signals and VIN plane.

[Tables 2](#) and [3](#) provide a design and layout checklist that a designer must pay attention to.

TABLE 2. DESIGN AND LAYOUT CHECKLIST

PIN NAME	NOISE SENSITIVITY	DESCRIPTION
EN	Yes	There is an internal 1 $\mu$ s filter. Decoupling the capacitor is NOT needed. However, if needed, use a low time constant one to avoid too large a shutdown delay.
VIN	Yes	Place 16V+ X7R 1 $\mu$ F in close proximity to the VIN pin and the system ground plane.
7VLDO	Yes	Place 10V+ X7R 1 $\mu$ F in close proximity to the 7VLDO pin and the system ground plane.
VCC	Yes	Place X7R 1 $\mu$ F in close proximity to the VCC pin and the system ground plane.

TABLE 2. DESIGN AND LAYOUT CHECKLIST (Continued)

PIN NAME	NOISE SENSITIVITY	DESCRIPTION
SCL, SDA	Yes	50kHz to 1.25MHz signal when the SMBus, PMBus, or I <sup>2</sup> C is sending commands. Pairing up with SALERT and routing carefully back to SMBus, PMBus or I <sup>2</sup> C master. 20 mils spacing within SDA, SALERT, and SCL; and more than 30 mils to all other signals. Refer to the SMBus, PMBus or I <sup>2</sup> C design guidelines and place proper terminated (pull-up) resistance for impedance matching. Tie them to GND when not used.
SALERT	No	Open-drain and high $dv/dt$ pin during transitions. Route it in the middle of SDA and SCL. Tie it to GND when not used.
PGOOD	No	Open-drain pin. Tie it to ground when not used.
RGND, VSEN	Yes	Differential pair routed to the remote sensing points with sufficient decoupling ceramics capacitors and not across or go above/under any switching nodes (BOOT, PHASE, UGATE, LGATE) or planes (VIN, PHASE, VOUT) even though they are not in the same layer. At least 20 mils spacing from other traces. DO NOT share the same trace with CSRTN.
CSRTN	Yes	Connect to the output rail side of the output inductor or current sensing resistor pin with a series resistor in close proximity to the pin. The series resistor sets the current gain and should be within 40 $\Omega$ and 3.5k $\Omega$ . Decoupling ( $\sim 0.1\mu F/X7R$ ) on the output end (not the pin) is optional and might be required for long sense trace and a poor layout.
CSEN	Yes	Connect to the phase node side of the output inductor or current sensing resistor pin with L/DCR or ESL/R <sub>SEN</sub> matching network in close proximity to CSEN and CSRTN pins. Differentially routing back to the controller with at least 20 mils spacing from other traces. Should NOT cross or go above/under the switching nodes [BOOT, PHASE, UGATE, LGATE] and power planes (VIN, PHASE, VOUT) even though they are not in the same layer.
NTC	Yes	Place NTC 10k (Murata, NCP15XH103J03RC, $\beta = 3380$ ) in close proximity to the output inductor's output rail, not close to MOSFET side; the return trace should be 20 mils away from other traces. Place 1.54k $\Omega$ pull-up and decoupling capacitor (typically 0.1 $\mu$ F) in close proximity to the controller. The pull-up resistor should be exactly tied to the same point as VCC pin, not through an RC filter. If not used, connect this pin to VCC.
IOUT	Yes	Scale R such that IOUT pin voltage is 2.5V at 63.875A load. Place R and C in general proximity to the controller. The time constant of RC should be sufficient as an averaging function for the digital I <sub>OUT</sub> . An external pull-up resistor to VCC is recommended to cancel I <sub>OUT</sub> offset at 0A load.

**TABLE 2. DESIGN AND LAYOUT CHECKLIST (Continued)**

PIN NAME	NOISE SENSITIVITY	DESCRIPTION
PROG1-4	No	Resistor divider must be referenced to VCC pin and the system ground; they can be placed anywhere. DO NOT use decoupling capacitors on these pins.
GND	Yes	Directly connect to low noise area of the system ground. The GND PAD should use at least 4 vias. Separate analog ground and power ground with a 0Ω resistor is highly NOT recommended.
FCCM	No	DO NOT make it across or under external components of the controller. Keep it at least 20 mils away from sensitive nodes.
PWM	No	DO NOT make it across or under external components of the controller. Keep it at least 20 mils away from any other traces.
LGIN	No	Keep it at least 20 mils away from sensitive nodes. A series 100Ω resistor to low-side gate signal is required for noise attenuation.
PVCC	Yes	Place X7R 4.7μF in proximity to the PVCC pin and the system ground plane.

**TABLE 3. TOP LAYOUT TIPS**

NUMBER	DESCRIPTION
1	The layer next to controller (top or bottom) should be a ground layer. Separate analog ground and power ground with a 0Ω resistor is highly NOT recommended. Directly connect GND PAD to low noise area of the system ground with at least 4 vias.
2	Never place a controller and its external components above or under VIN plane or any switching nodes.
3	Never share CSRTN and VSEN on the same trace.
4	Place the input rail decoupling ceramic capacitors closely to the high-side FET. Never use only one via and a trace to connect the input rail decoupling ceramics capacitors; must connect to VIN and GND planes.
5	Place all decoupling capacitors in close proximity to the controller and the system ground plane.
6	Connect remote sense (VSEN and RGND) to the load and ceramic decoupling capacitors nodes; never run this pair below or above switching noise plane.
7	Always double check critical component pinout and their respective footprints.

# ISL68201-99140DEMO1Z Schematics

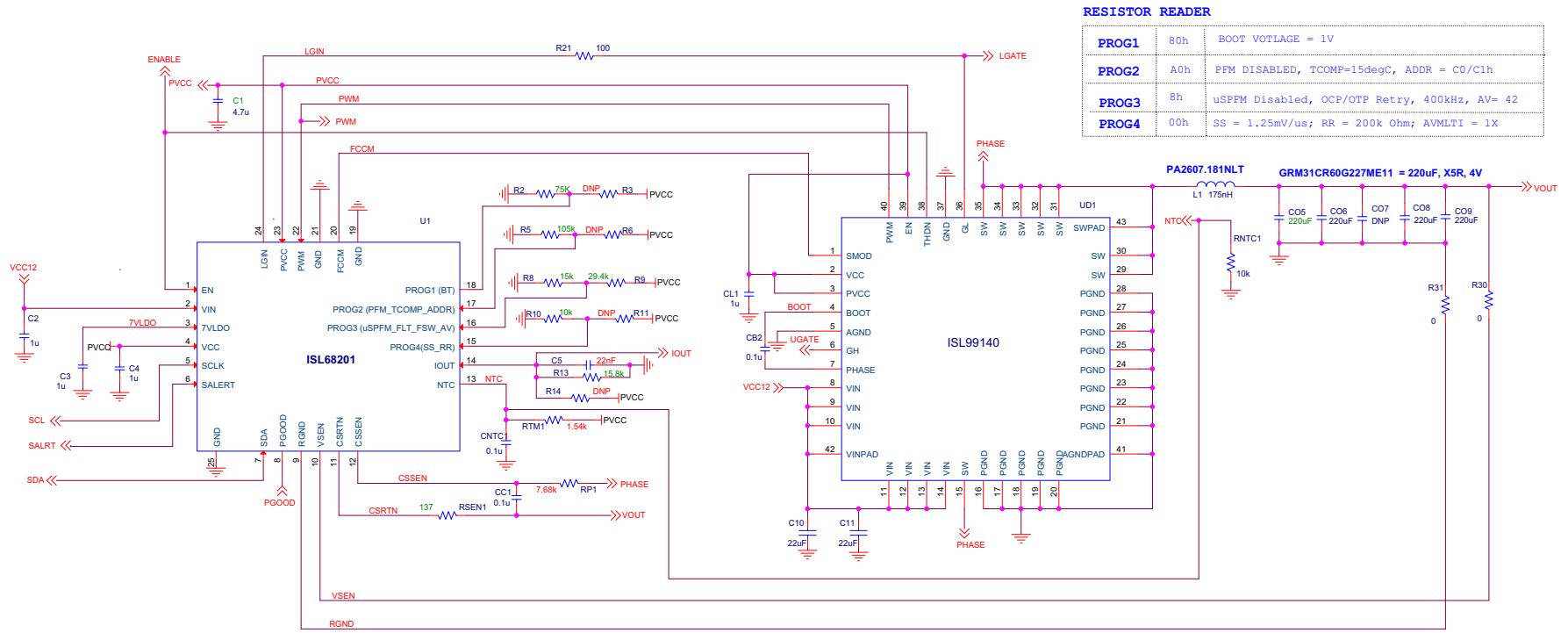

FIGURE 6. ISL68201-99140DEMO1Z 1V AT 35A BUCK SOLUTION SCHEMATICS (1 OF 2)

# ISL68201-99140DEMO1Z Schematics (Continued)

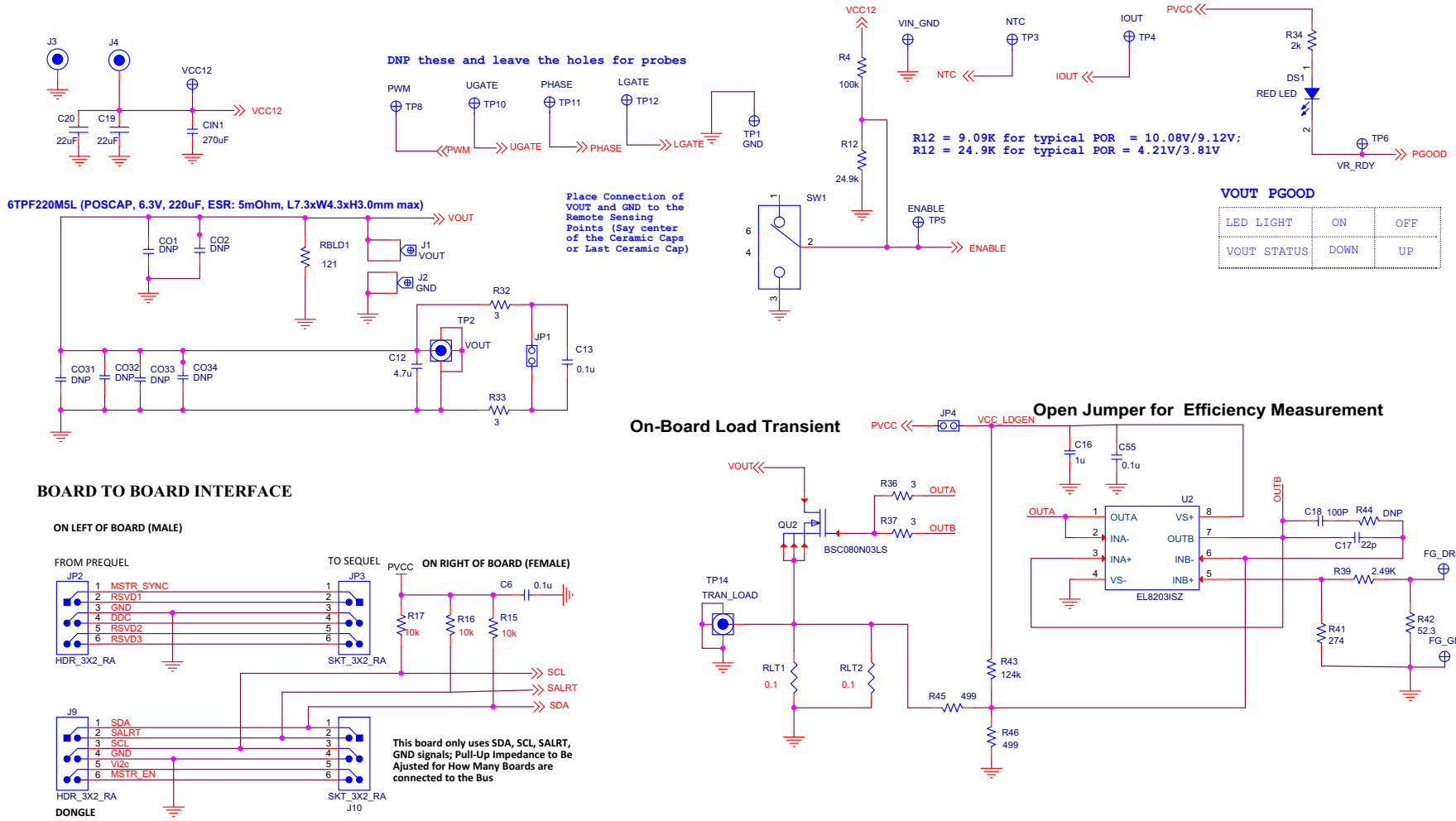

FIGURE 7. I/O CONNECTORS, AUXILIARY CIRCUITS AND ON-BOARD TRANSIENT LOAD SCHEMATICS (2 OF 2)



## Bill of Materials

QTY	REFERENCE DESIGNATOR	DESCRIPTION	PCB FOOTPRINT	MANUFACTURER	PART NUMBER
1	U1	R4 Wrapper	QFN24_157X157_197_EPC	INTERSIL	ISL68201IRZ-REVC
1	UD1	40A DrMOS PWR MODULE	EPQFN40_6X6	INTERSIL	ISL99140IRZ
1	CIN1	270µF/16V/8x9/10mΩ	CAPR_315X275_150_P	SANYO	16SEPC270MX
1	C1	4.7µF/6.3V/X5R	SM0603	VENKEL	C0603X5R6R3-475KNE
2	C2, C3	1.0µF/16V/X7R	SM0402	TDK	C1005X5R1C105K050BC
1	C4	1µF/6.3V/X5R	SM0402	PANASONIC	ECJ-0EBOJ105K
1	C5	22nF/50V/X7R	SM0402	JOHANSON DIELECTRICS INC	500R07W223KV4T
1	C6	0.1µF/16V/X7R	SM0603	MURATA	GRM39X7R104K016AD
3	CB2, CC1, CNTC1	0.1µF/16V/X7R	SM0402	VENKEL	C0402X7R160-104KNE
4	C10, C11, C19, C20	22µF/16V/X5R	SM0805	VENKEL	C0805X5R160-226KNE
4	CO5, CO6, CO8, CO9	220µF/4V/X5R	SM1206	MURATA	GRM31CR60G227ME11
1	L1	175nH, 0.29mΩ	SMD, 10.4X7.9	PULSE	PA2607.181NLT
1	R2	75kΩ, 1%	SM0402	VENKEL	CR0402-16W-7502FT
1	R4	100kΩ, 1%	SM0603	VENKEL	CR0603-10W-1003FT
1	R5	105kΩ, 1%	SM0402	VENKEL	CR0402-16W-1053FT
1	R8	15kΩ, 1%	SM0402	PANASONIC	ERJ-3EKF1502V
1	R9	29.4kΩ, 1%	SM0402	VENKEL	CR0402-16W-2942FT
1	R10	10kΩ, 1%	SM0402	PANASONIC	ERJ-2RKF1002X
3	R15, R16, R17	10kΩ, 1%	SM0603	VENKEL	CR0603-10W-1002FT
1	R12	24.9kΩ, 1%	SM0603	PANASONIC	ERJ-3EKF2492V
1	R13	15.8kΩ, 1%	SM0402	YAGEO	RC0402FR-0715K8L
1	R21	100Ω, 1%	SM0402	VENKEL	CR0402-16W-101JT
2	R30, R31	0Ω	SM0402	PANASONIC	ERJ-2RKF00R0X
1	RBLD1	121Ω, 1%	SM0603	VISHAY/DALE	CRCW0603121RFKTA
1	RNTC1	10kΩ NTC, 5%, β = 3380	SM0402	MURATA	NCP15XH103J03RC
1	RP1	7.68kΩ, 1%	SM0402	PANASONIC	ERJ-2RKF7681X
1	RSEN1	137Ω, 1%	SM0402	PANASONIC	ERJ-2RKF1370X
1	RTM1	1.54kΩ, 1%	SM0402	PANASONIC	ERJ-2RKF1541X
<b>DEMONSTRATION BOARD SPECIFIC AUXILIARY PARTS BILL OF MATERIALS</b>					
1	U2	Dual Amp/500MHz/5V	SOIC8	INTERSIL	EL8203ISZ
1	QU2	8mΩ N-MOSFET	LPAK	INFINEON	BSC080N03LS G
1	DS1	LED/RED/0805/CLEAR	SM0805	WURTH ELEKTRONIK	150080RS75000
1	SW1	Enable Switch	GT11SC	C&K DIVISION	GT11MSCBE
1	C12	4.7µF/6.3V/X5R	SM0603	VENKEL	C0603X5R6R3-475KNE
2	C13, C55	0.1µF/16V/X7R	SM0402	VENKEL	C0402X7R160-104KNE
1	C16	1µF/6.3V/X5R	SM0402	PANASONIC	ECJ-0EBOJ105K
1	C17	22pF/50V/C0G	SM0603	VENKEL	C0603C0G500-220JNE
1	C18	100pF/50V/C0G	SM0603	PANASONIC	ECJ-1VC1H101J

**Bill of Materials** (Continued)

QTY	REFERENCE DESIGNATOR	DESCRIPTION	PCB FOOTPRINT	MANUFACTURER	PART NUMBER
2	J1, J2	Screw Terminal	B2C-PCB	INTERNATIONAL HYDRAULICS INC	B2C-PCB
1	J3	Female Banana Jack, Black	111-07xx-001	JOHNSON COMPONENTS	111-0703-001
1	J4	Female Banana Jack, Red	111-07xx-001	JOHNSON COMPONENTS	111-0702-001
2	J8, J9	CONN-HEADER, 2x3, BRKAWY, 2.54mm, TIN	CONN6	SAMTEC	TSW-103-08-T-D-RA
2	J10, J11	CONN-SOCKET STRIP, TH, 2x3, 2.54mm, TIN	CONN6	SAMTEC	SSQ-103-02-T-D-RA
2	JP1, JP4	2-pin 0.1" spacing Jumper	CONN2	BERG/FCI	69190-202HLF
1	TP1	Probe Ground	TP-150C100P-RTP	KEYSTONE	1514-2
2	TP2, TP14	Probe Jack	TEK131-4353-00	TEKTRONIX	131-4353-00
4	TP3, TP4, TP5, TP6	Test Point	MTP500x	KEYSTONE	5002
2	VCC12, FG_DRIVE	Test Point RED	MTP500x	KEYSTONE	5000
2	VIN_GND, FG_GND	Test Point BLACK	MTP500x	KEYSTONE	5001
4	R32, R33, R36, R37	3 $\Omega$ , 1%	SM0603	VENKEL	CR0603-10W-03R0FT
1	R34	2k $\Omega$ , 1%	SM0603	KOA	RK73H1JTDD2001F
1	R39	2.49k $\Omega$ , 1%	SM0603	KOA	RK73H1JTDD2491F
1	R42	52.3 $\Omega$ , 1%	SM0603	PANASONIC	ERJ-3EKF52R3V
1	R41	274 $\Omega$ , 1%	SM0603	VENKEL	CR0603-10W-2740FT
1	R43	124k $\Omega$ , 1%	SM0603	YAGEO	9C06031A1243FKHFT
2	R45, R46	499 $\Omega$ , 1%	SM0603	VENKEL	CR0603-10W-4990FT
2	RLT1, RLT2	0.1 $\Omega$ , 1%	SM2512	CTS RESISTOR	73L7R10J

# Performance Data

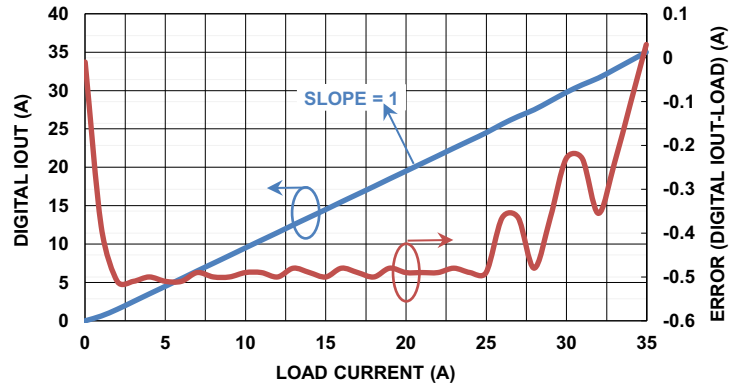

FIGURE 8. TYPICAL DIGITAL OUTPUT CURRENT

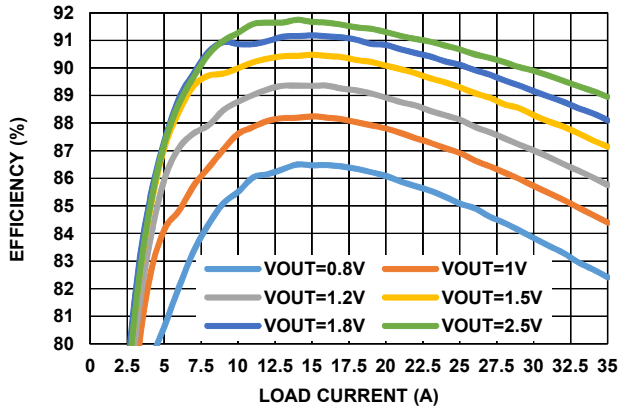

FIGURE 9. EFFICIENCY,  $V_{IN} = 12V$ ,  $f_{SW} = 400kHz$

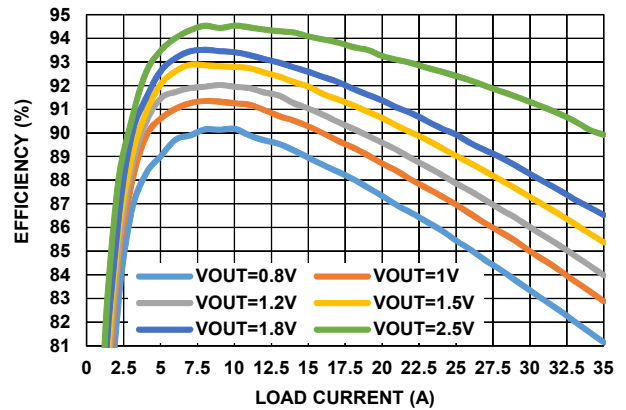

FIGURE 10. EFFICIENCY,  $V_{IN} = 5V$ ,  $f_{SW} = 400kHz$

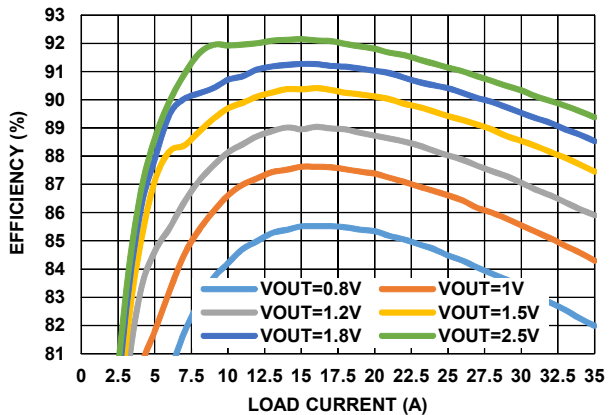

FIGURE 11. EFFICIENCY,  $V_{IN} = 12V$ ,  $f_{SW} = 500kHz$

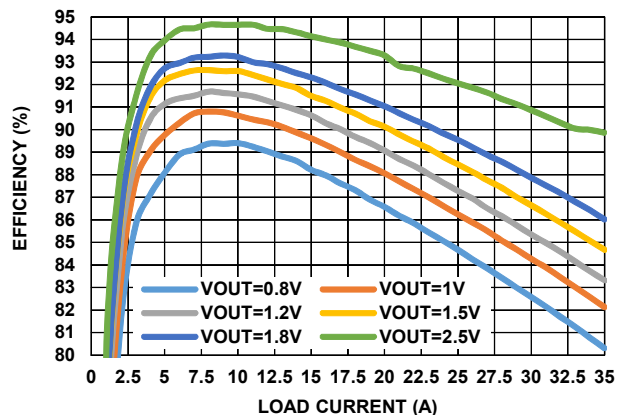

FIGURE 12. EFFICIENCY,  $V_{IN} = 5V$ ,  $f_{SW} = 500kHz$

## Performance Data (Continued)

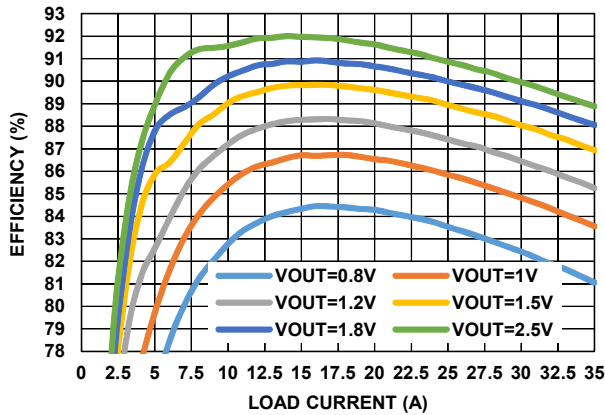

FIGURE 13. EFFICIENCY,  $V_{IN} = 12V$ ,  $f_{SW} = 600kHz$

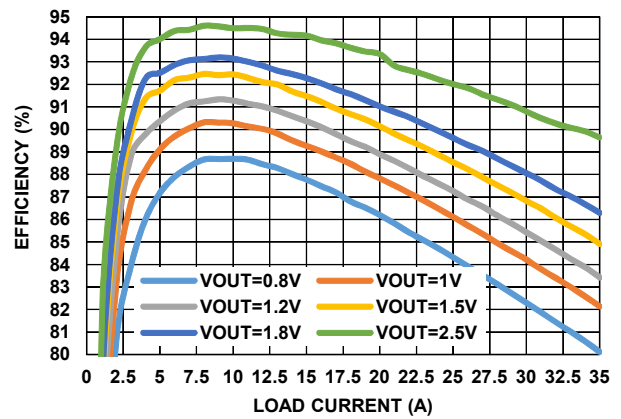

FIGURE 14. EFFICIENCY,  $V_{IN} = 5V$ ,  $f_{SW} = 600kHz$

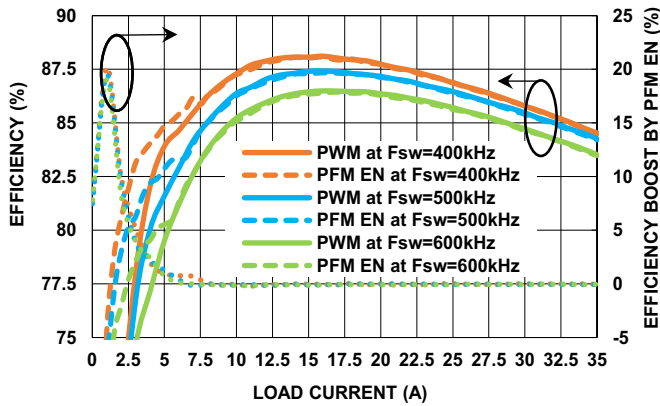

FIGURE 15. EFFICIENCY COMPARISON OF PWM MODE AND PFM ENABLED MODE,  $V_{IN} = 12V$ ,  $V_{OUT} = 1V$

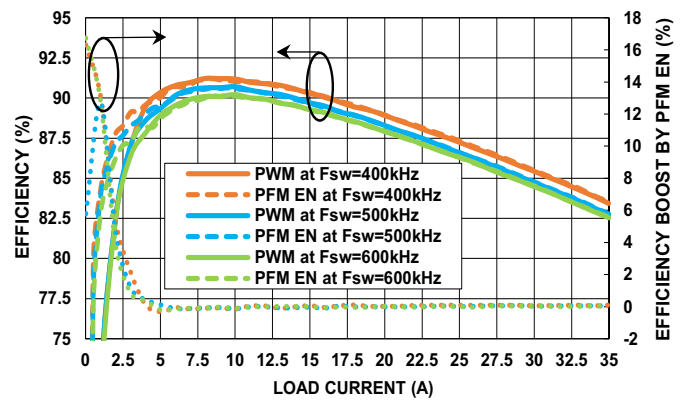

FIGURE 16. EFFICIENCY COMPARISON OF PWM MODE AND PFM ENABLED MODE,  $V_{IN} = 5V$ ,  $V_{OUT} = 1V$

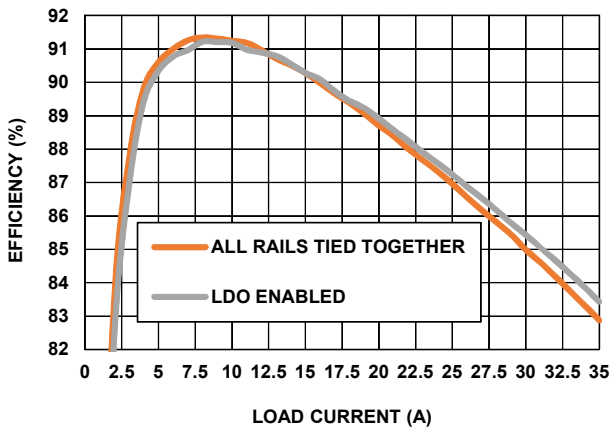

FIGURE 17. EFFICIENCY COMPARISON OF LDO ENABLED AND BYPASSED,  $V_{IN} = 5V$ ,  $V_{OUT} = 1V$ ,  $f_{SW} = 500kHz$

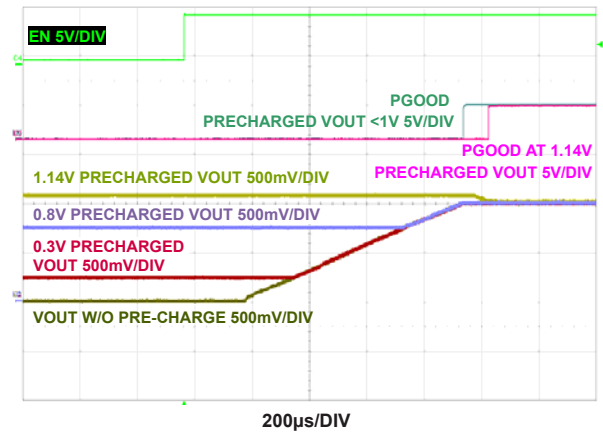

FIGURE 18. POWER-UP WITH/WITHOUT PRE-CHARGED LOAD

**Performance Data** (Continued)

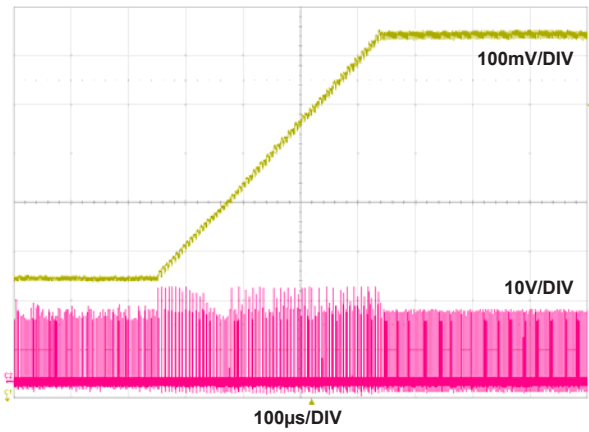

FIGURE 19.  $V_{OUT}$  RAMP-UP FROM 0.5V TO 1V IN PWM MODE (CH1-VOUT, CH2-PHASE)

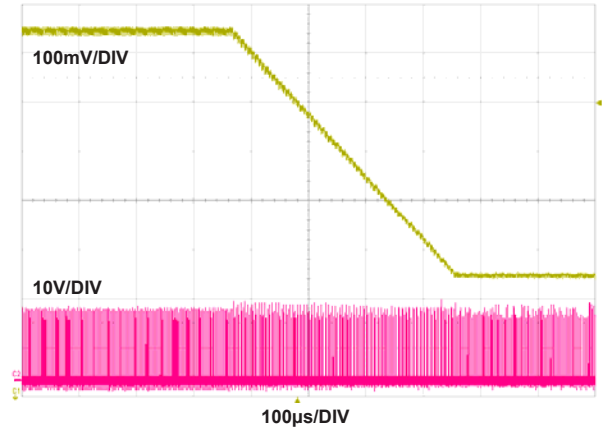

FIGURE 20.  $V_{OUT}$  RAMP-DOWN FROM 1V TO 0.5V IN PWM MODE (CH1-VOUT, CH2-PHASE)

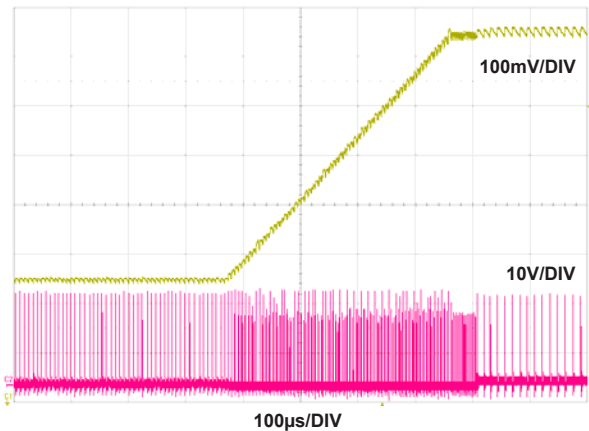

FIGURE 21.  $V_{OUT}$  RAMP-UP FROM 0.5V TO 1V IN PFM MODE (CH1-VOUT, CH2-PHASE)

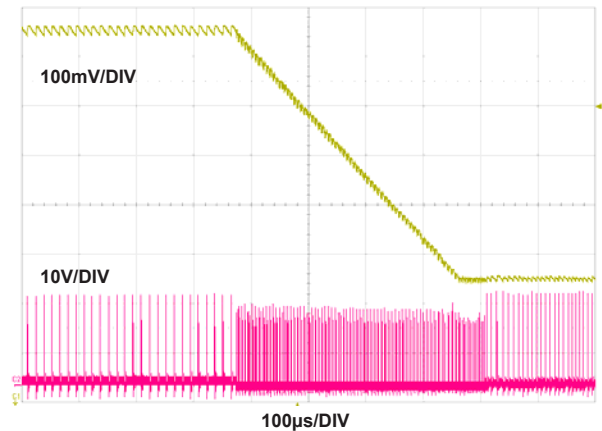

FIGURE 22.  $V_{OUT}$  RAMP-DOWN FROM 1V TO 0.5V IN PFM MODE (CH1-VOUT, CH2-PHASE)

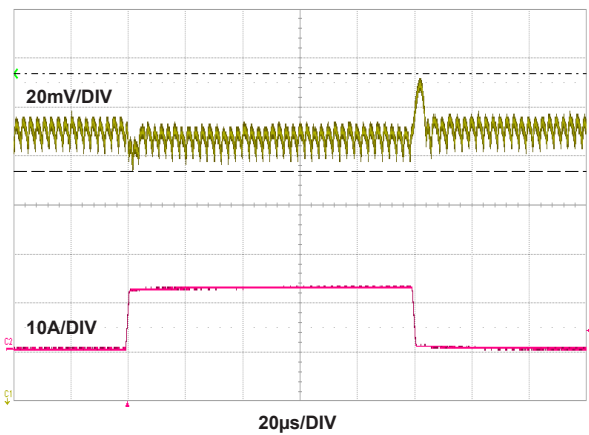

FIGURE 23. STEP RESPONSE AT PWM MODE,  $V_{OUT} = 1V$ ,  $f_{SW} = 400kHz$ , LOAD PROFILE: 0.25A TO 12.75A AT 25A/ $\mu s$  (CH1-VOUT, CH2-LOAD)

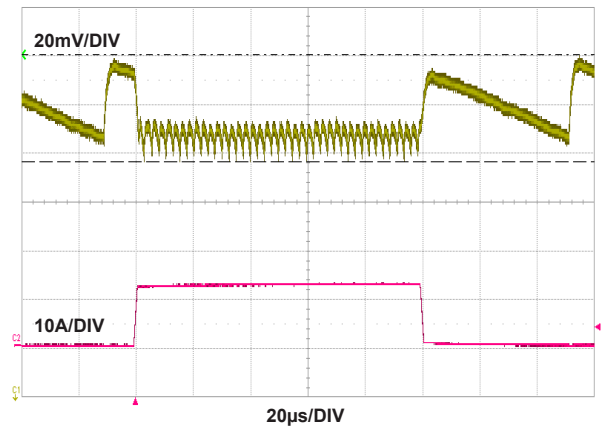

FIGURE 24. STEP RESPONSE AT PFM ENABLED MODE,  $V_{OUT} = 1V$ ,  $f_{SW} = 400kHz$ , LOAD PROFILE: 0.25A TO 12.75A AT 25A/ $\mu s$  (CH1-VOUT, CH2-LOAD)

## Performance Data (Continued)

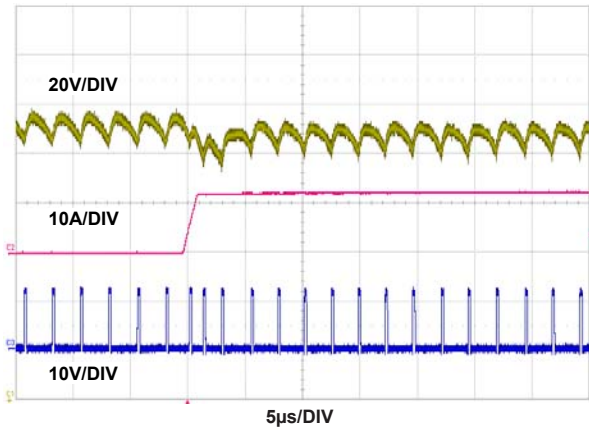

FIGURE 25. STEP RESPONSE TO LOAD STEP AT PWM MODE,  $V_{OUT} = 1V$ ,  $f_{SW} = 400kHz$ , LOAD PROFILE: 0.25A TO 12.75A AT 25A/ $\mu s$  (CH1-VOUT, CH2-LOAD, CH3-PHASE)

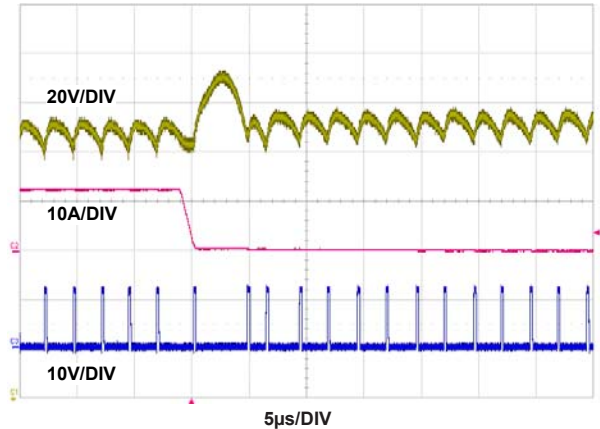

FIGURE 26. STEP RESPONSE TO LOAD RELEASE AT PWM MODE,  $V_{OUT} = 1V$ ,  $f_{SW} = 400kHz$ , LOAD PROFILE: 0.25A TO 12.75A AT 25A/ $\mu s$  (CH1-VOUT, CH2-LOAD, CH3-PHASE)

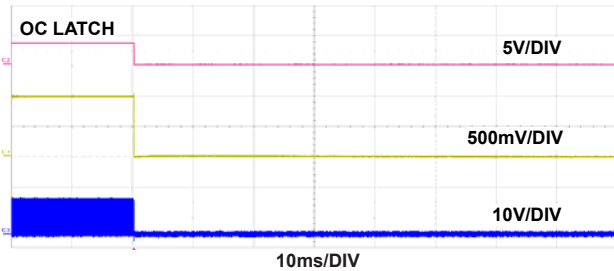
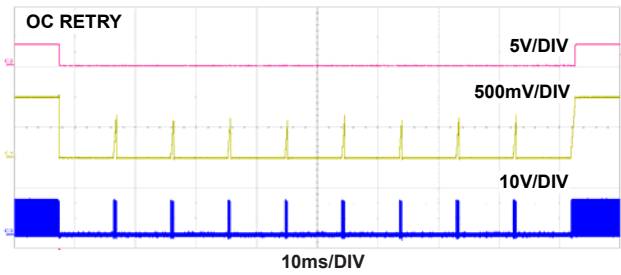

FIGURE 27. OVERCURRENT AND SHORT-CIRCUIT PROTECTION (CH1-VOUT, CH2-PGOOD, CH3-PHASE)

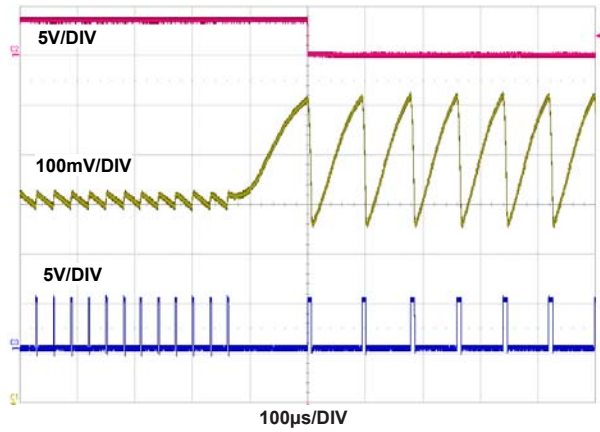

FIGURE 28. OVERVOLTAGE PROTECTION (CH1-VOUT, CH2-PGOOD, CH3-LGATE)

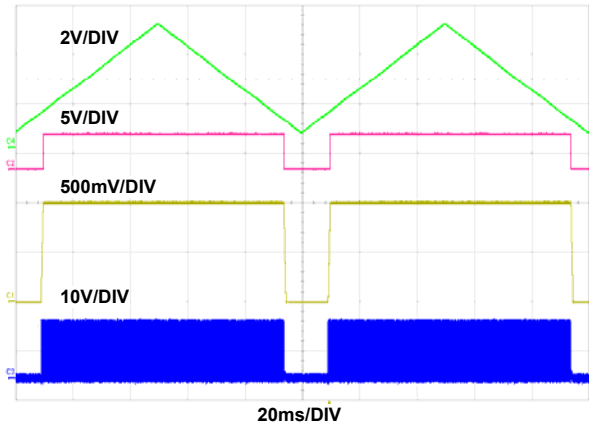

FIGURE 29. OVER-TEMPERATURE PROTECTION AT 1A LOAD (CH1-VOUT, CH2-LOAD, CH3-PHASE, CH4-NTC)

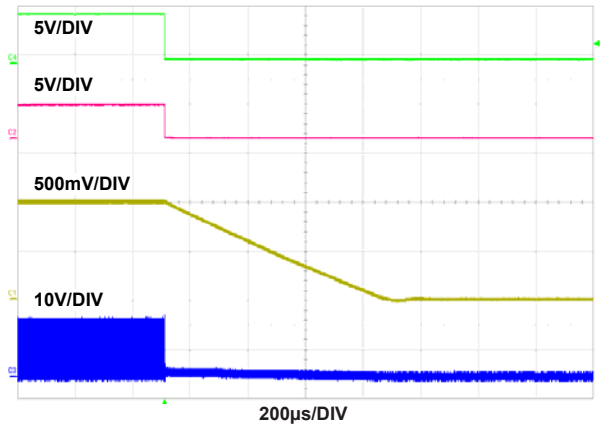

FIGURE 30. POWER-DOWN AT  $V_{OUT} = 1V$ , 1A LOAD (CH1-VOUT, CH2-PGOOD, CH3-PHASE, CH4-EN)

# ISL68201-99140DEMO1Z Board Layout

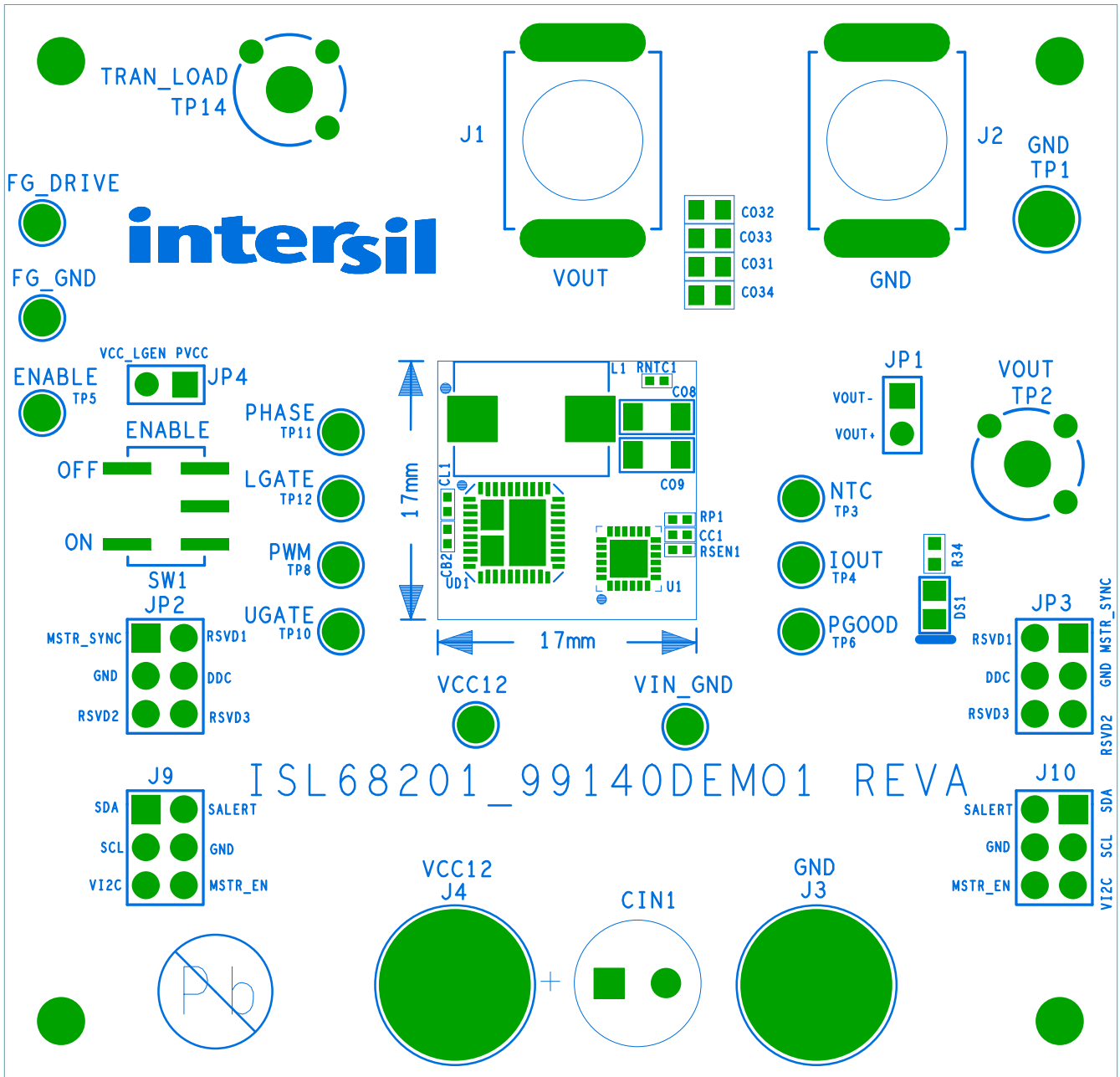

FIGURE 31. PCB - TOP ASSEMBLY

# ISL68201-99140DEMO1Z Board Layout (Continued)

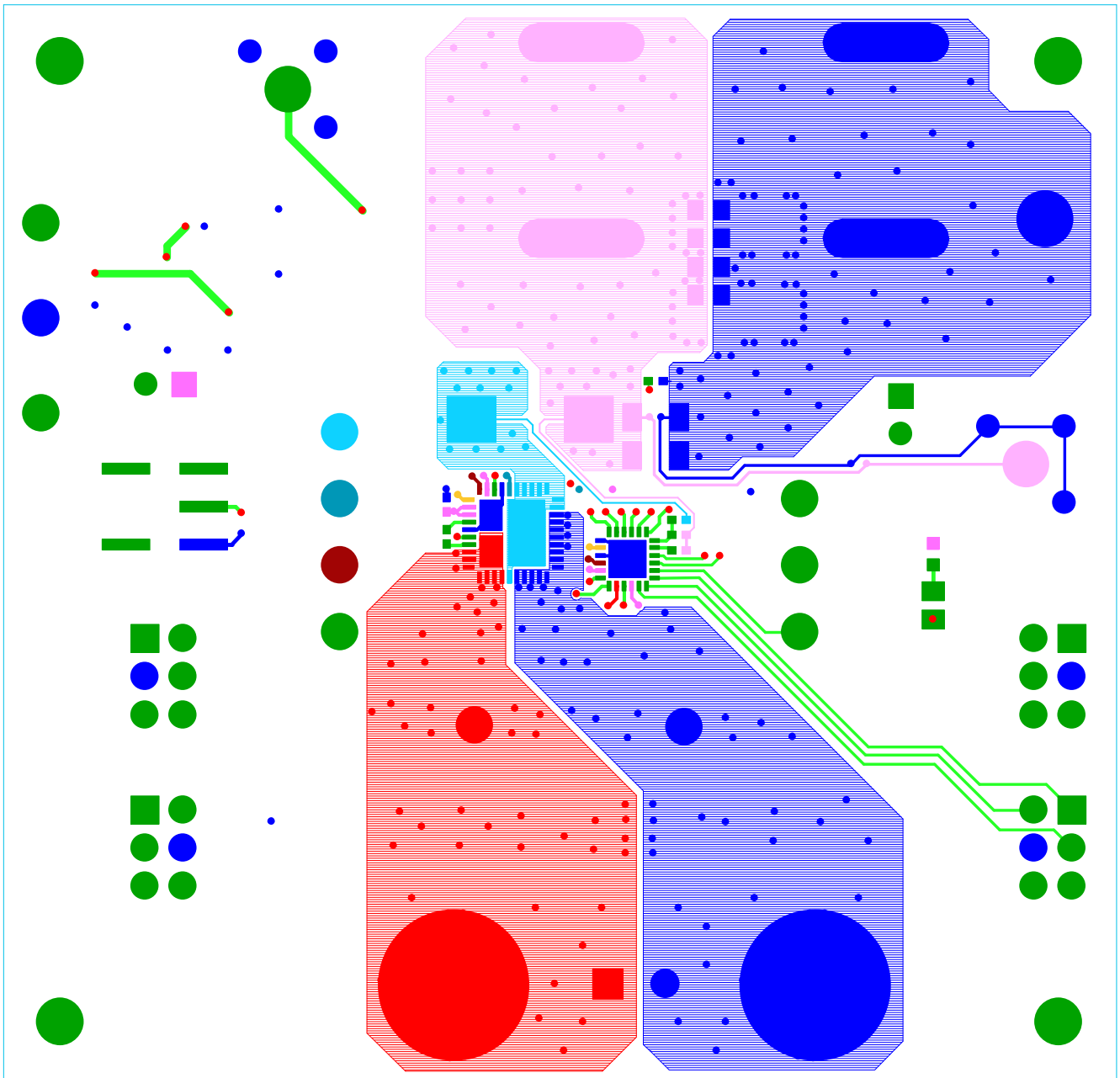

FIGURE 32. PCB - TOP LAYER



**ISL68201-99140DEMO1Z Board Layout** (Continued)

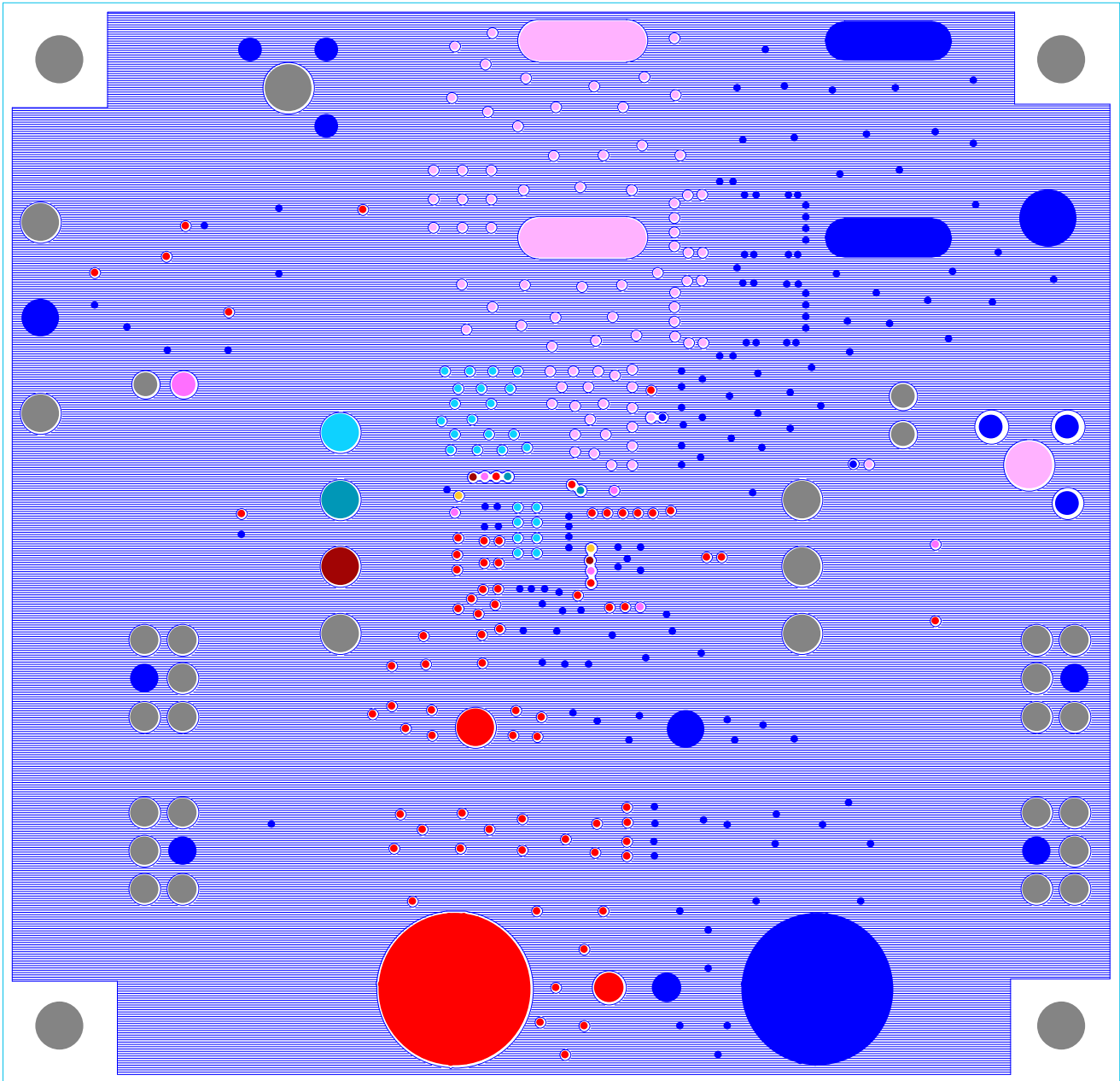

FIGURE 33. PCB - INNER LAYER 2 (TOP VIEW)

# ISL68201-99140DEMO1Z Board Layout (Continued)

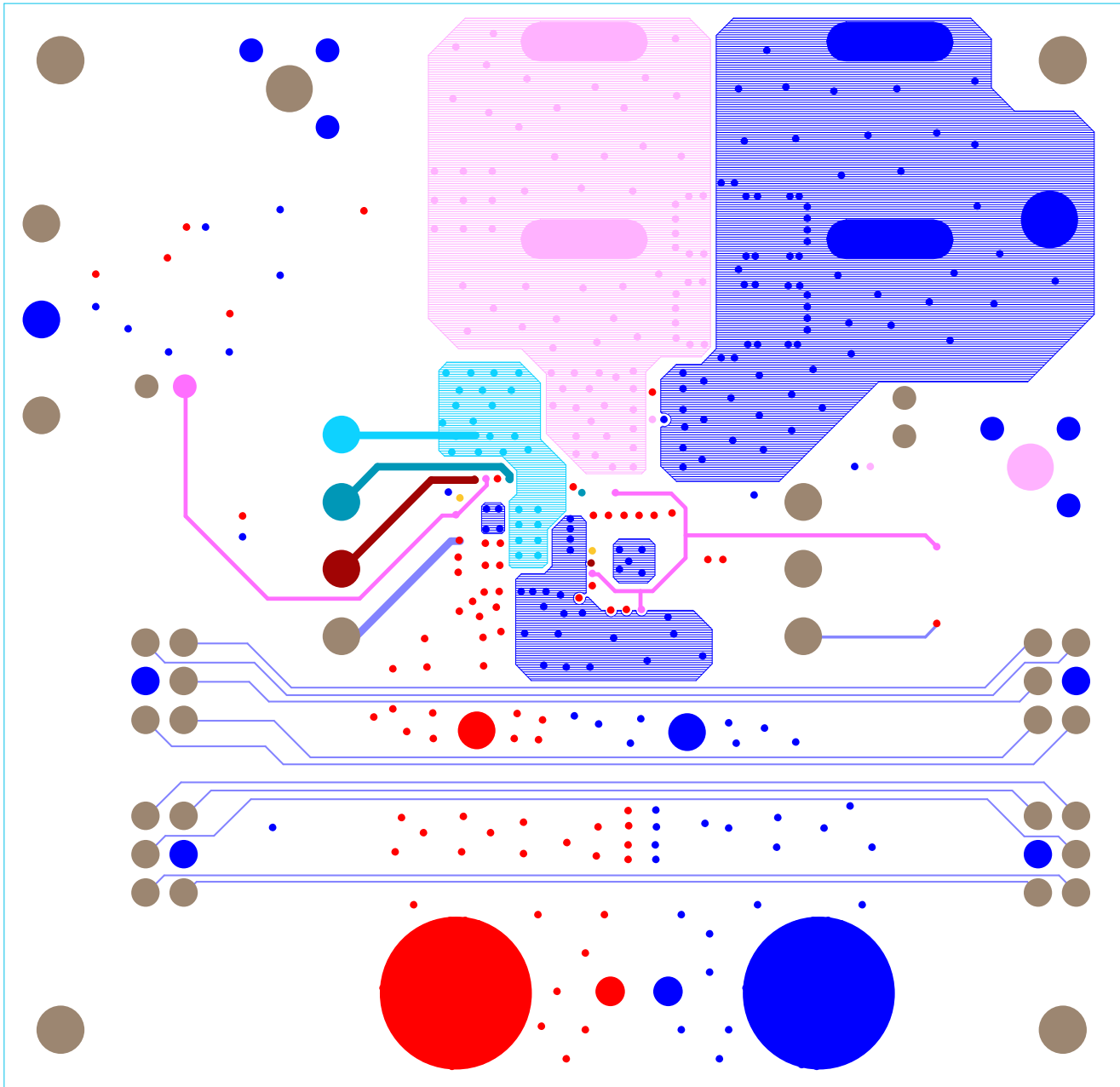

FIGURE 34. PCB - INNER LAYER 3 (TOP VIEW)

## ISL68201-99140DEMO1Z Board Layout (Continued)

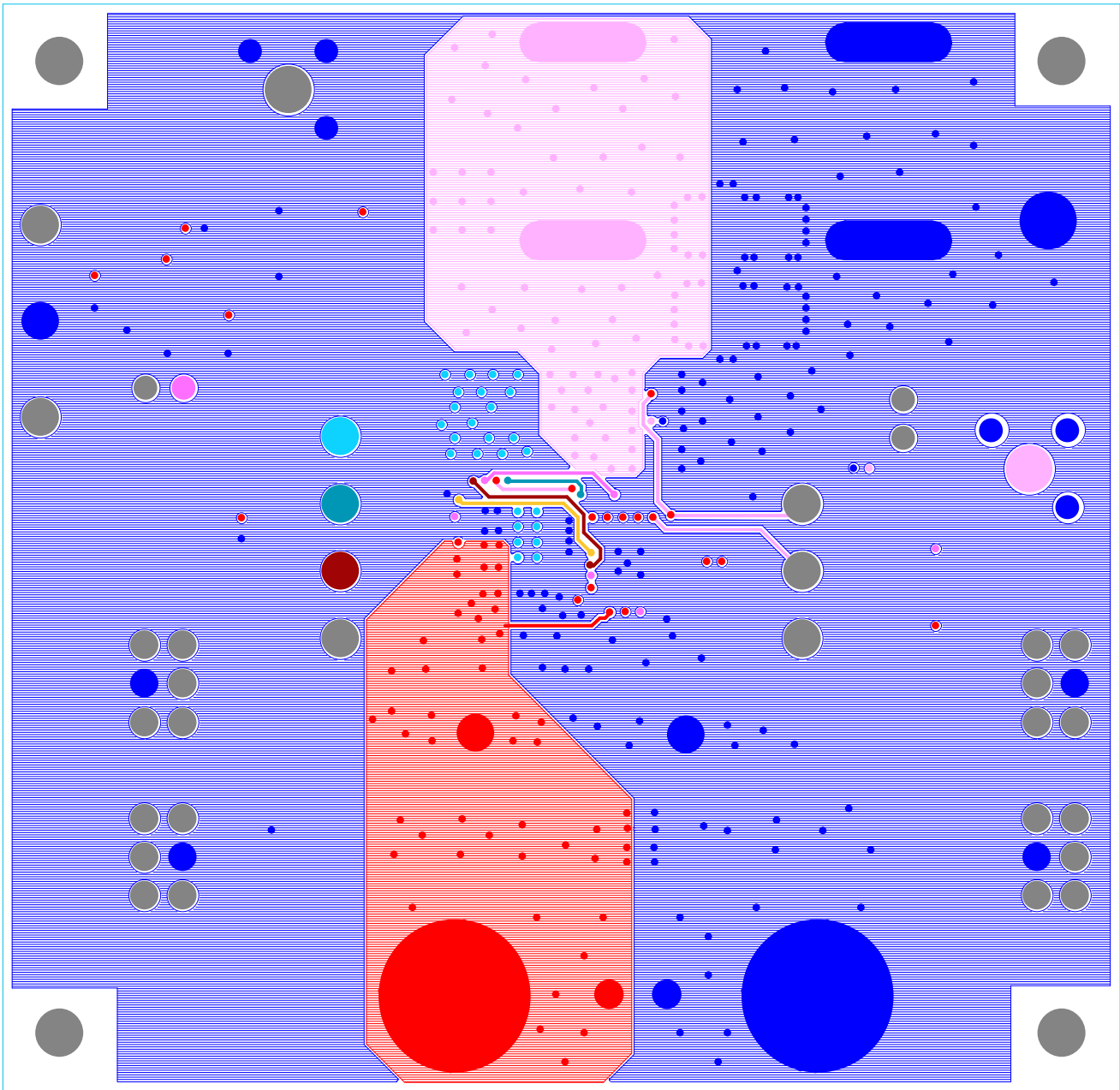

FIGURE 35. PCB - INNER LAYER 4 (TOP VIEW)

# ISL68201-99140DEMO1Z Board Layout (Continued)

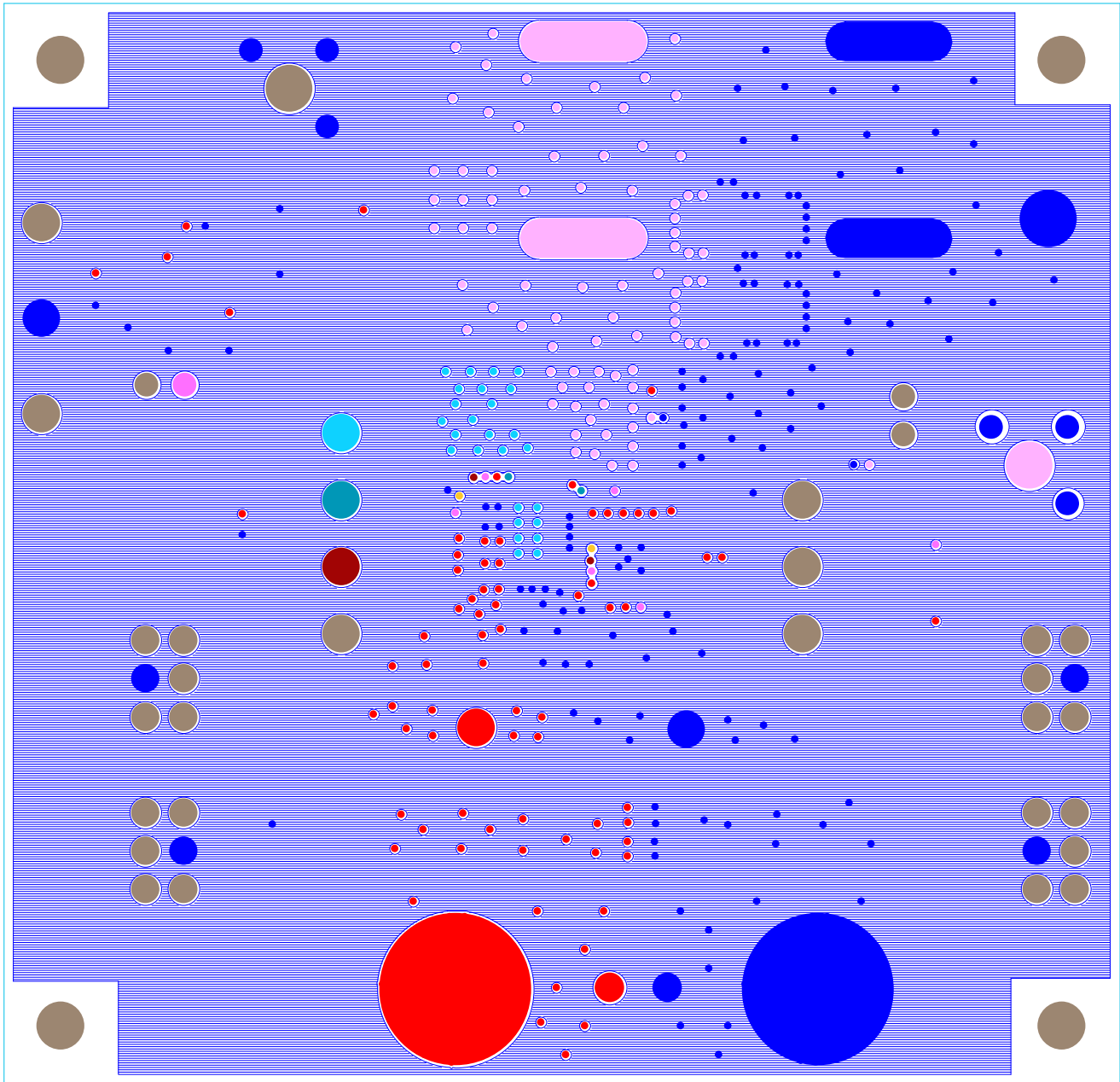

FIGURE 36. PCB - INNER LAYER 5 (TOP VIEW)

# ISL68201-99140DEMO1Z Board Layout (Continued)

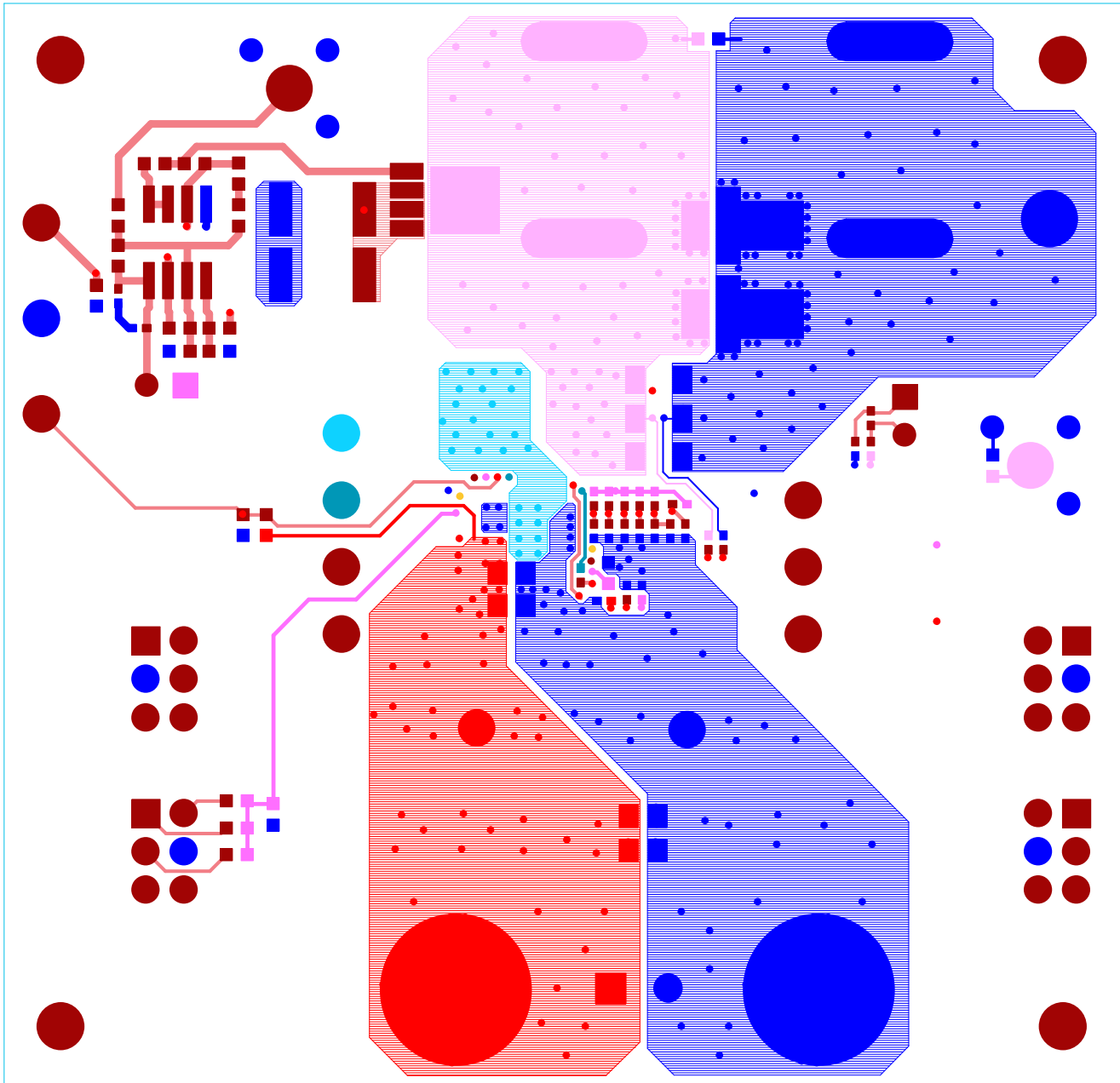

FIGURE 37. PCB - BOTTOM LAYER (TOP VIEW)

**ISL68201-99140DEMO1Z Board Layout (Continued)**

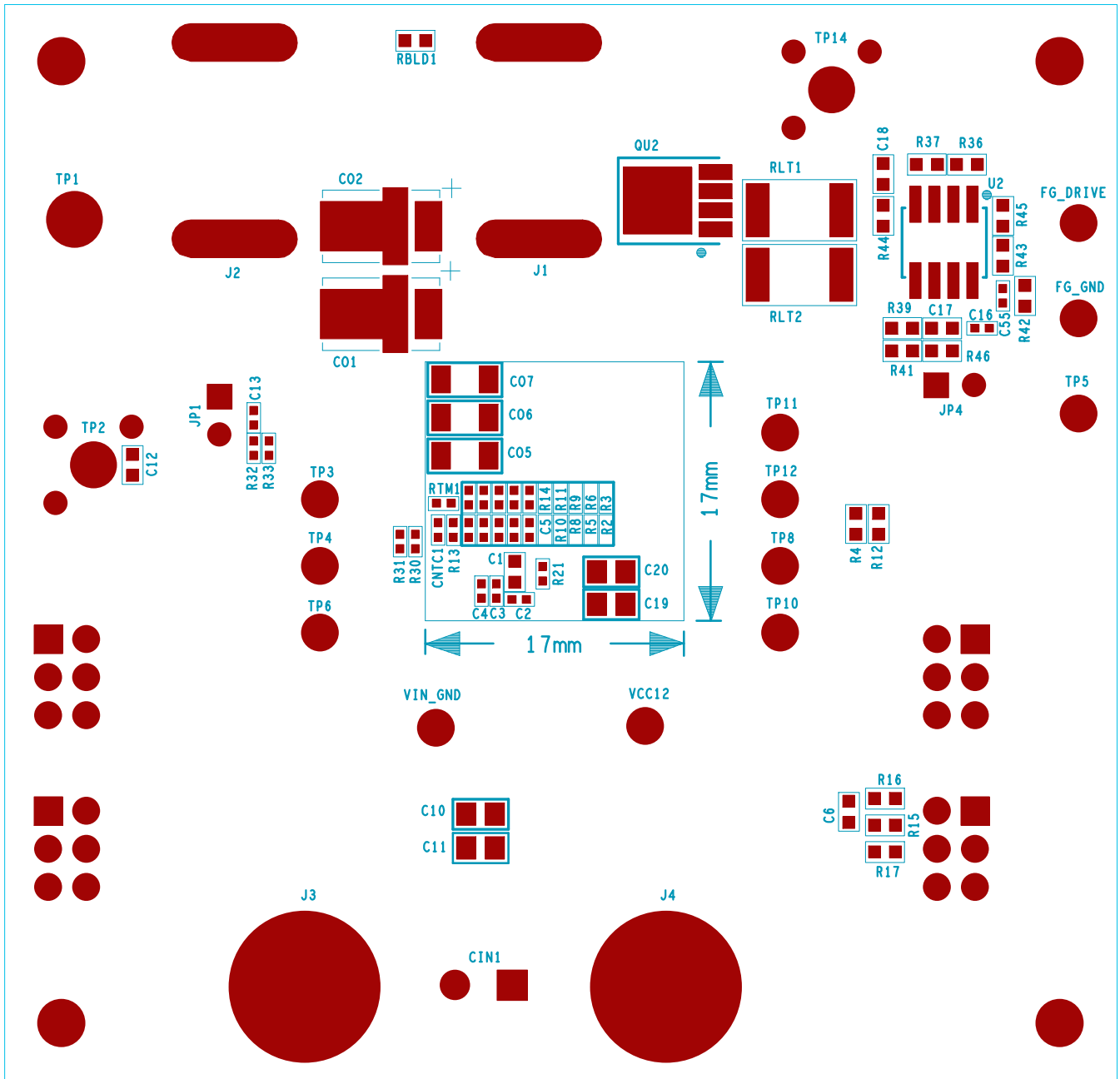

FIGURE 38. PCB - BOTTOM ASSEMBLY (TOP VIEW)

## Notice

1. Descriptions of circuits, software and other related information in this document are provided only to illustrate the operation of semiconductor products and application examples. You are fully responsible for the incorporation or any other use of the circuits, software, and information in the design of your product or system. Renesas Electronics disclaims any and all liability for any losses and damages incurred by you or third parties arising from the use of these circuits, software, or information.
2. Renesas Electronics hereby expressly disclaims any warranties against and liability for infringement or any other claims involving patents, copyrights, or other intellectual property rights of third parties, by or arising from the use of Renesas Electronics products or technical information described in this document, including but not limited to, the product data, drawings, charts, programs, algorithms, and application examples.
3. No license, express, implied or otherwise, is granted hereby under any patents, copyrights or other intellectual property rights of Renesas Electronics or others.
4. You shall not alter, modify, copy, or reverse engineer any Renesas Electronics product, whether in whole or in part. Renesas Electronics disclaims any and all liability for any losses or damages incurred by you or third parties arising from such alteration, modification, copying or reverse engineering.
5. Renesas Electronics products are classified according to the following two quality grades: "Standard" and "High Quality". The intended applications for each Renesas Electronics product depends on the product's quality grade, as indicated below.  
"Standard": Computers; office equipment; communications equipment; test and measurement equipment; audio and visual equipment; home electronic appliances; machine tools; personal electronic equipment; industrial robots; etc.  
"High Quality": Transportation equipment (automobiles, trains, ships, etc.); traffic control (traffic lights); large-scale communication equipment; key financial terminal systems; safety control equipment; etc.  
Unless expressly designated as a high reliability product or a product for harsh environments in a Renesas Electronics data sheet or other Renesas Electronics document, Renesas Electronics products are not intended or authorized for use in products or systems that may pose a direct threat to human life or bodily injury (artificial life support devices or systems; surgical implantations; etc.), or may cause serious property damage (space system; undersea repeaters; nuclear power control systems; aircraft control systems; key plant systems; military equipment; etc.). Renesas Electronics disclaims any and all liability for any damages or losses incurred by you or any third parties arising from the use of any Renesas Electronics product that is inconsistent with any Renesas Electronics data sheet, user's manual or other Renesas Electronics document.
6. When using Renesas Electronics products, refer to the latest product information (data sheets, user's manuals, application notes, "General Notes for Handling and Using Semiconductor Devices" in the reliability handbook, etc.), and ensure that usage conditions are within the ranges specified by Renesas Electronics with respect to maximum ratings, operating power supply voltage range, heat dissipation characteristics, installation, etc. Renesas Electronics disclaims any and all liability for any malfunctions, failure or accident arising out of the use of Renesas Electronics products outside of such specified ranges.
7. Although Renesas Electronics endeavors to improve the quality and reliability of Renesas Electronics products, semiconductor products have specific characteristics, such as the occurrence of failure at a certain rate and malfunctions under certain use conditions. Unless designated as a high reliability product or a product for harsh environments in a Renesas Electronics data sheet or other Renesas Electronics document, Renesas Electronics products are not subject to radiation resistance design. You are responsible for implementing safety measures to guard against the possibility of bodily injury, injury or damage caused by fire, and/or danger to the public in the event of a failure or malfunction of Renesas Electronics products, such as safety design for hardware and software, including but not limited to redundancy, fire control and malfunction prevention, appropriate treatment for aging degradation or any other appropriate measures. Because the evaluation of microcomputer software alone is very difficult and impractical, you are responsible for evaluating the safety of the final products or systems manufactured by you.
8. Please contact a Renesas Electronics sales office for details as to environmental matters such as the environmental compatibility of each Renesas Electronics product. You are responsible for carefully and sufficiently investigating applicable laws and regulations that regulate the inclusion or use of controlled substances, including without limitation, the EU RoHS Directive, and using Renesas Electronics products in compliance with all these applicable laws and regulations. Renesas Electronics disclaims any and all liability for damages or losses occurring as a result of your noncompliance with applicable laws and regulations.
9. Renesas Electronics products and technologies shall not be used for or incorporated into any products or systems whose manufacture, use, or sale is prohibited under any applicable domestic or foreign laws or regulations. You shall comply with any applicable export control laws and regulations promulgated and administered by the governments of any countries asserting jurisdiction over the parties or transactions.
10. It is the responsibility of the buyer or distributor of Renesas Electronics products, or any other party who distributes, disposes of, or otherwise sells or transfers the product to a third party, to notify such third party in advance of the contents and conditions set forth in this document.
11. This document shall not be reprinted, reproduced or duplicated in any form, in whole or in part, without prior written consent of Renesas Electronics.
12. Please contact a Renesas Electronics sales office if you have any questions regarding the information contained in this document or Renesas Electronics products.  
(Note 1) "Renesas Electronics" as used in this document means Renesas Electronics Corporation and also includes its directly or indirectly controlled subsidiaries.  
(Note 2) "Renesas Electronics product(s)" means any product developed or manufactured by or for Renesas Electronics.

(Rev.4.0-1 November 2017)



### SALES OFFICES

Renesas Electronics Corporation

<http://www.renesas.com>

Refer to "<http://www.renesas.com/>" for the latest and detailed information.

**Renesas Electronics America Inc.**  
1001 Murphy Ranch Road, Milpitas, CA 95035, U.S.A.  
Tel: +1-408-432-8888, Fax: +1-408-434-5351

**Renesas Electronics Canada Limited**  
9251 Yonge Street, Suite 8309 Richmond Hill, Ontario Canada L4C 9T3  
Tel: +1-905-237-2004

**Renesas Electronics Europe Limited**  
Dukes Meadow, Millboard Road, Bourne End, Buckinghamshire, SL8 5FH, U.K  
Tel: +44-1628-651-700, Fax: +44-1628-651-804

**Renesas Electronics Europe GmbH**  
Arcadiastrasse 10, 40472 Düsseldorf, Germany  
Tel: +49-211-6503-0, Fax: +49-211-6503-1327

**Renesas Electronics (China) Co., Ltd.**  
Room 1709 Quantum Plaza, No.27 ZhichunLu, Haidian District, Beijing, 100191 P. R. China  
Tel: +86-10-8235-1155, Fax: +86-10-8235-7679

**Renesas Electronics (Shanghai) Co., Ltd.**  
Unit 301, Tower A, Central Towers, 555 Langao Road, Putuo District, Shanghai, 200333 P. R. China  
Tel: +86-21-2226-0888, Fax: +86-21-2226-0999

**Renesas Electronics Hong Kong Limited**  
Unit 1601-1611, 16/F., Tower 2, Grand Century Place, 193 Prince Edward Road West, Mongkok, Kowloon, Hong Kong  
Tel: +852-2265-6688, Fax: +852-2886-9022

**Renesas Electronics Taiwan Co., Ltd.**  
13F, No. 363, Fu Shing North Road, Taipei 10543, Taiwan  
Tel: +886-2-8175-9600, Fax: +886-2-8175-9670

**Renesas Electronics Singapore Pte. Ltd.**  
80 Bendemeer Road, Unit #06-02 Hyflux Innovation Centre, Singapore 339949  
Tel: +65-6213-0200, Fax: +65-6213-0300

**Renesas Electronics Malaysia Sdn.Bhd.**  
Unit 1207, Block B, Menara Amcorp, Amcorp Trade Centre, No. 18, Jln Persiaran Barat, 46050 Petaling Jaya, Selangor Darul Ehsan, Malaysia  
Tel: +60-3-7955-9390, Fax: +60-3-7955-9510

**Renesas Electronics India Pvt. Ltd.**  
No.777C, 100 Feet Road, HAL 2nd Stage, Indiranagar, Bangalore 560 038, India  
Tel: +91-80-67208700, Fax: +91-80-67208777

**Renesas Electronics Korea Co., Ltd.**  
17F, KAMCO Yangjae Tower, 262, Gangnam-daero, Gangnam-gu, Seoul, 06265 Korea  
Tel: +82-2-558-3737, Fax: +82-2-558-5338