

ISL76534EVAL1Z

Evaluation Board User Guide

UG083
Rev 0.00
July 25, 2016

Description

The ISL76534EVAL1Z is a complete platform for the evaluation on all datasheet specifications and functionalities of the programmable gamma buffer. The [ISL76534](#) contains an I²C programmable, 10-bit, 14-channel gamma reference voltage generator with buffered outputs, a 10-bit programmable V_{COM} calibrator, a high output current V_{COM} amplifier and an internal EEPROM to store all reference voltage data. The EEPROM features an endurance of 10,000 write cycles and a data retention of 20yrs at 105 °C.

The ISL76534EVAL1Z board is intended to provide an evaluation platform for the 4mmx5mm X2QFN ISL76534 package, programmable gamma buffer.

Specifications

- Ambient temperature range, -40 °C to +105 °C
- Analog supply voltage, A_{VDD} = 6.3V to 19V
- Digital supply voltage, D_{VDD} = 2.25 to 3.6V
- Output channels x14, OUTx = 0V to A_{VDD}-Headroom
- Output channel x1, V_{COM} = 0V to A_{VDD}-Headroom

References

- [ISL76534](#) datasheet

Features

- 15-Channel reference voltage outputs, I²C programmable:
 - 14-channel gamma references, 10-bit resolution with buffered outputs
 - 1-channel V_{COM} calibrator with 10-bit resolution
- High output current V_{COM} amplifier
- Ultra-low power operation, ideal for tablet and mobile applications: typical quiescent power, 12mW at 8V A_{VDD}
- EEPROM data retention: 20yrs at 105 °C
- EEPROM endurance: 10,000 write cycles
 - Read/write capable over 2.25V to 3.6V D_{VDD} range
- 6.3V to 19V analog supply operating range
- 2.25V to 3.6V digital supply operating range
- 28 Ld 4x5mm super thin X2QFN package
- Pb-free (RoHS compliant)
- [AEC-Q100](#) qualified

Ordering Information

PART #	DESCRIPTION
ISL76534EVAL1Z	Evaluation board for the 4x5 X2QFN package

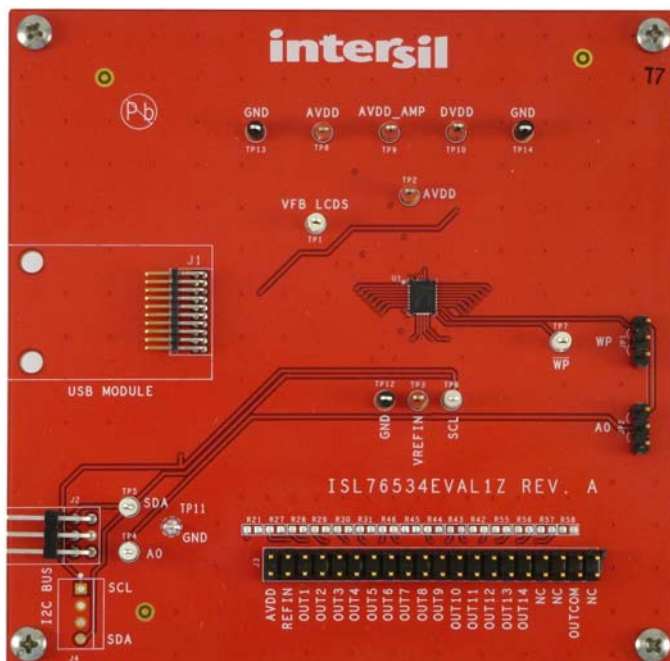

FIGURE 1. ISL76534EVAL1Z TOP VIEW

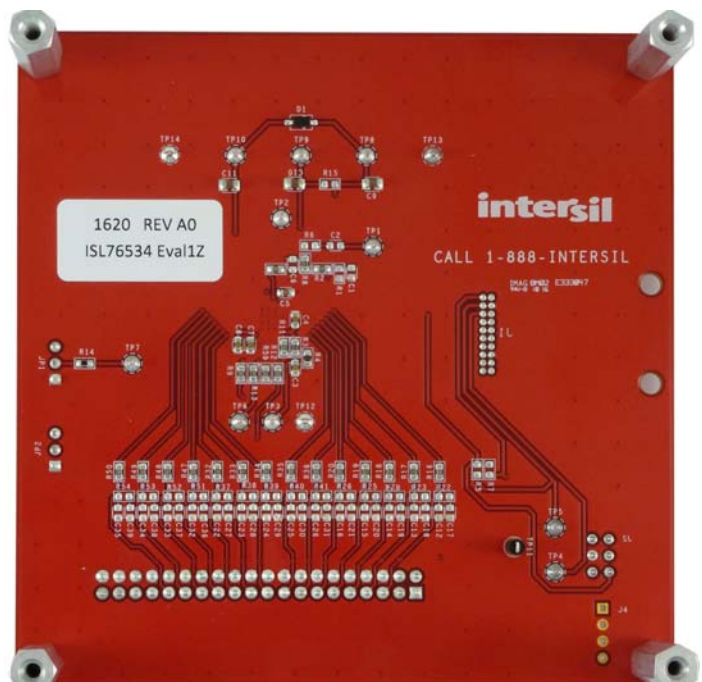

FIGURE 2. ISL76534EVAL1Z BOTTOM VIEW

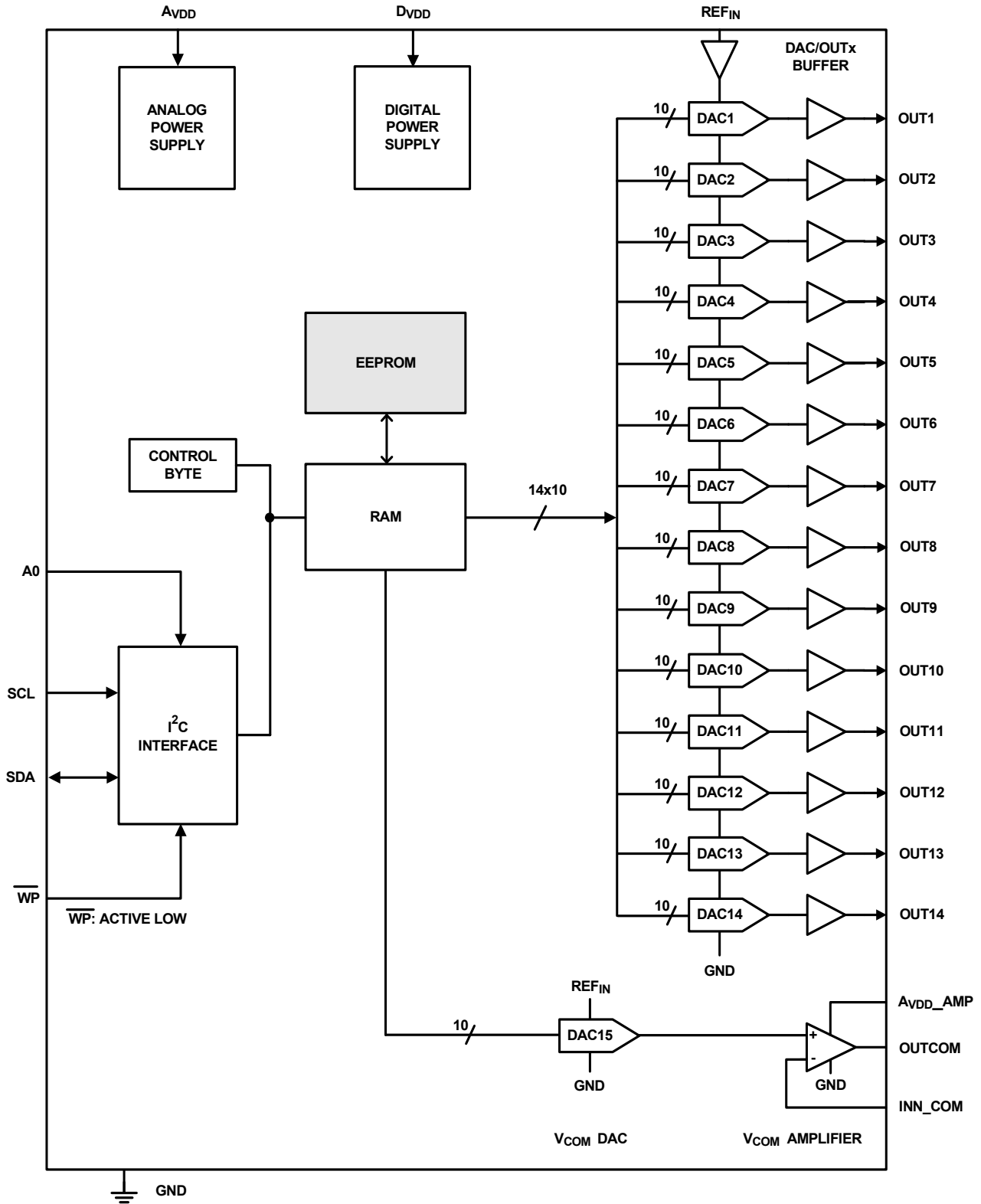

FIGURE 3. BLOCK DIAGRAM

What Is Inside

The evaluation kit contains:

- ISL76534EVAL1Z board
- The [ISL76534](#) datasheet
- This ISL76534EVAL1Z user guide
- ISLUSBMINIZEVAL1Z (USB to I²C module)

What Is Needed

The following instruments will be needed to perform testing:

- Power supplies:
 - PS1: DC 20V/5A, (between AVDD and AVDD_AMP and GND)
 - PS2: DC 20V/5A, (between DVDD and GND)
- Multimeters
- Oscilloscope
- Cables and wires

Initial Set-Up

This user guide describes how to set up and use the ISL76534EVAL1Z evaluation board along with the ISLUSBMINIZEVAL1Z in a standalone configuration. It explains how to install the software and how to use the Windows interface to read and write to the ISL76534 data register and EEPROM.

Evaluation Software

The next section explains how to install the Graphical User Interface (GUI) software, which is used to configure the ISL76534 data registers and EEPROM.

Notes

The GUI software was developed on a 64-bit Windows 8 platform. Because the GUI software registers as a Human Interface Device (HID) and uses standard HID calls, it should also work on other XP or later Windows operating systems (32-bit and 64-bit), including Windows 7.

This user guide contains screenshots of the GUI at the time this user guide was written. Subsequent GUI versions may appear differently.

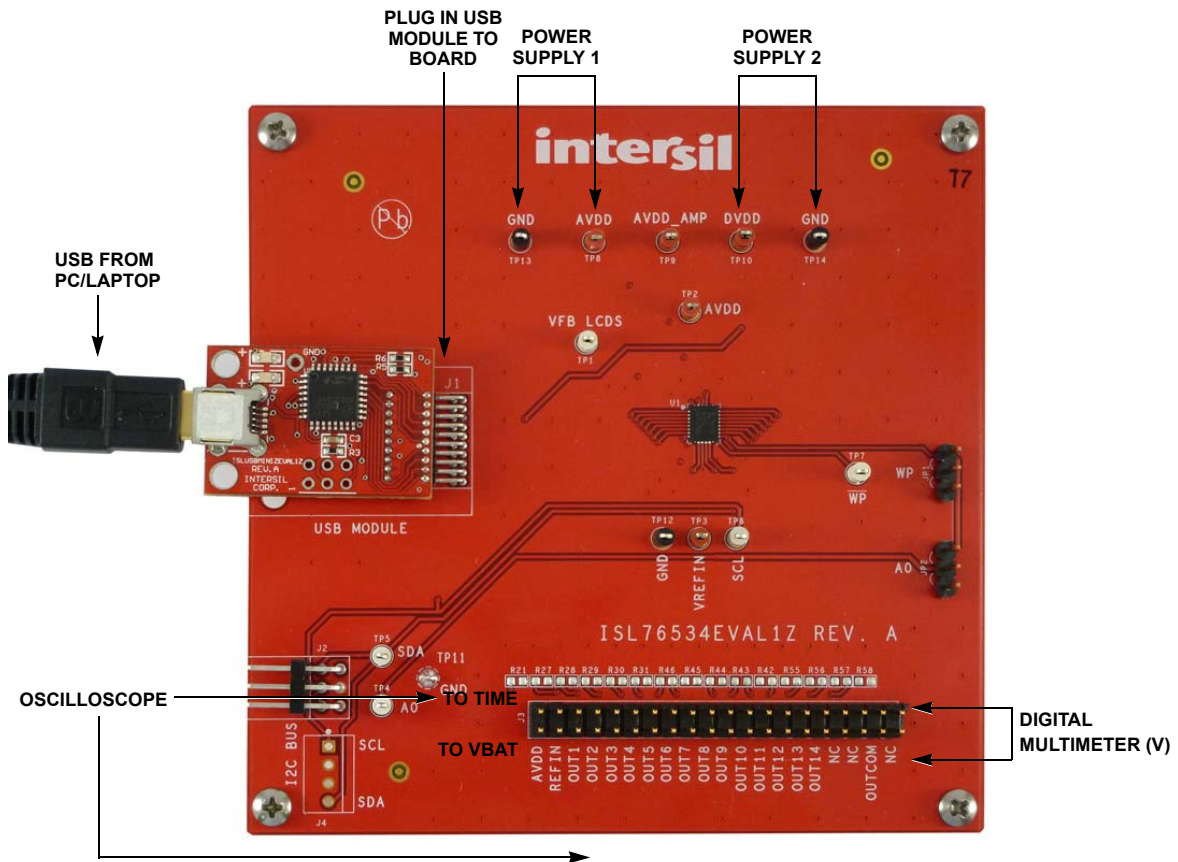

FIGURE 4. EXTERNAL CONNECTIONS AND JUMPERS

Software Installation Guide

The ISL76534EVAL1Z software can be installed from an installer file downloaded from the [ISL76534](#) product information page on the Intersil web site.

Launch the “[isl76534_installer.exe](#)” file and follow the instructions ([Figure 5](#)). The default installation adds an “Intersil” directory to the “Start Menu\Programs” tree. That directory will contain a shortcut to the ISL76534 executable, and an uninstaller.

The default install option places the main program files in the C:\Program Files\Intersil\ISL76534 directory; however, the location can be customized, if desired.

Click **Next** to continue to the license agreement ([Figure 5](#)).

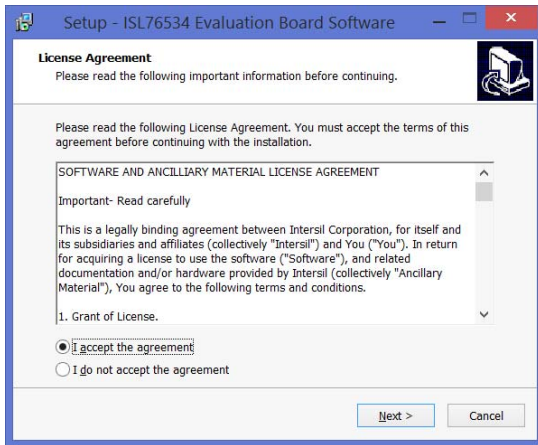

FIGURE 5. LICENSE AGREEMENT

Read the license agreement, choose to accept (or not accept) the license agreement, then click **Next**. The **Select Destination Location** window opens ([Figure 6](#)).

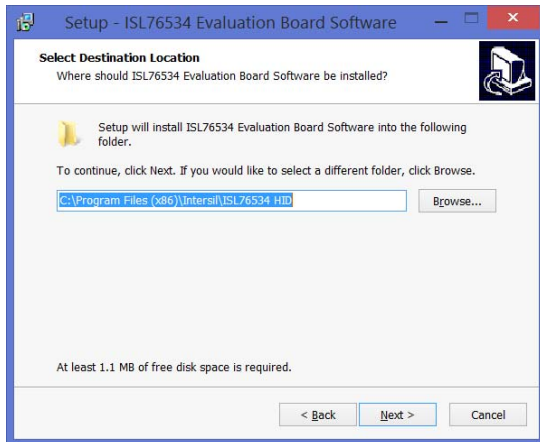

FIGURE 6. SELECT DESTINATION LOCATION

To use a directory different from the default location, click the **Browse** button. Click **Next** to continue to the **Select Start Menu Folder** screen ([Figure 7](#)).

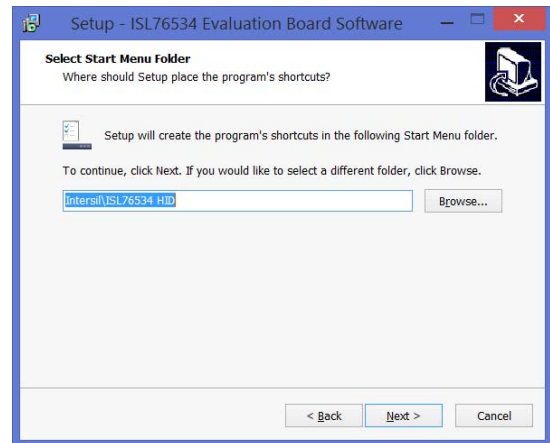

FIGURE 7. SELECT START MENU FOLDER

Click **Next** to create the Intersil folder in the **Start** menu. The **Ready to Install** window opens ([Figure 8](#)).

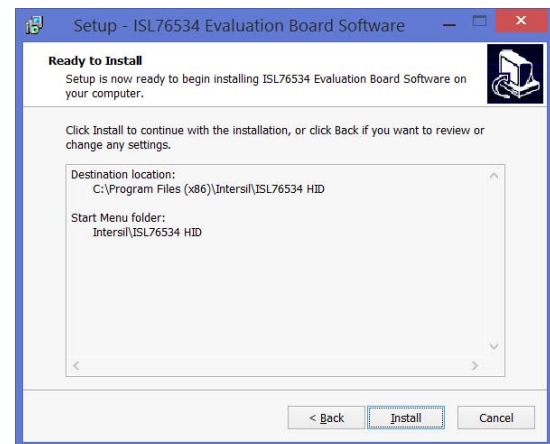

FIGURE 8. BEGIN INSTALLATION

Click **Install** to copy all the necessary files to the PC. Installation is now complete. Reboot the PC if requested.

Hardware Set-up Guide

Initial Board Jumper Positioning

JP1 - Is used to set the logic level of the Write Protection pin \overline{WP} . Shorting JP1-1 and -2 grounds the \overline{WP} and prevents I²C data write to the internal DAC registers. This is the default if the pin is left floating. Shorting JP1-2 and -3 provides a high on the \overline{WP} and thereby allows a data write to the internal DAC registers. Note the pin has an internal pull down to GND.

JP2 - This pin determines the 7-bit I²C device address. Shorting JP1-1 and -2 grounds the A0 and sets it to low which equates to a device address of 0x74. This is the default setting if the pin is left floating. Shorting JP1-2 and -3 provides a high on the A0, which sets the I²C address to 0x75 (pulled up externally). Note that the pin has an internal pull down to GND.

After the software is installed, the evaluation board is ready to be interfaced through the PC.

1. Verify that the WP0 on JP1 is tied high if you wish to write to the device register/EEPROM.
2. Using jumper JP2 tie A0 = LOW for an I²C address of 0x74 OR A0 = HIGH for an I²C address of 0x75.
3. Connect the power supply ground(s) to the GND posts TP13 and TP14.
4. Apply 15V (range = 4.5V to 19V) to the AV_{DD} and AV_{DD}_AMP analog supply posts TP8 and TP9.
5. Apply digital supply (2.25 to 3.6V) to the V_{DD} post TP10.
6. Verify that the correct voltage is present across the power supply pins and that the board is drawing reasonable current. To verify at AV_{DD} = 15V and DV_{DD} = 3.3V, I_{AVDD} is about 1.9mA (typical) and I_{DD} is about 160μA (typical).
7. Connect the evaluation board to the PC with a USB cable.

USB Module Installation

When the ISLUSBMINIZEVAL1Z USB module is initially connected to the PC, Windows may display the **Found New Hardware** pop-up message.

This message means the USB module is registering itself as an HID on your computer. The process should complete within a few seconds.

On XP systems, a pop-up message may appear, displaying the status of the USB module hardware.

If a **Found New Hardware** window appears asking for the location of device drivers, please contact Intersil for a new USB module.

Using the Software GUI

Launch the software from the default location:
Start Menu\Programs\Intersil\ISL76534

After the program launches, you should see the screen shown in [Figure 9](#).

8. Set Display = HEX
9. AV_{DD} = 15V (Actual voltage setting on the AV_{DD} supply).
10. REF_{IN} = 14.75V (REF_{IN} is divided down to this value from AV_{DD} on the evaluation board).
11. Set the appropriate I²C address on the GUI and click OK.
12. Choose **Zero Fill** to write 0x00 to all registers.
13. Choose **3FF Fill** to write 0x3FF to all the registers.
14. Choose **Custom Fill** to write a user defined value to all the registers after entering the value in the Custom Value input box. The data sliders can also be used to vary individual register value setting if needed.
15. Probe the OUT₁ to OUT₁₄ and read the programmed voltage level based on the data written to the registers or EEPROM.
16. Probe the V_{COM} node and verify that it outputs the programmed voltage level based on the data written to the registers or EEPROM.
17. Turn off all supplies and disconnect the USB interface from the PC.

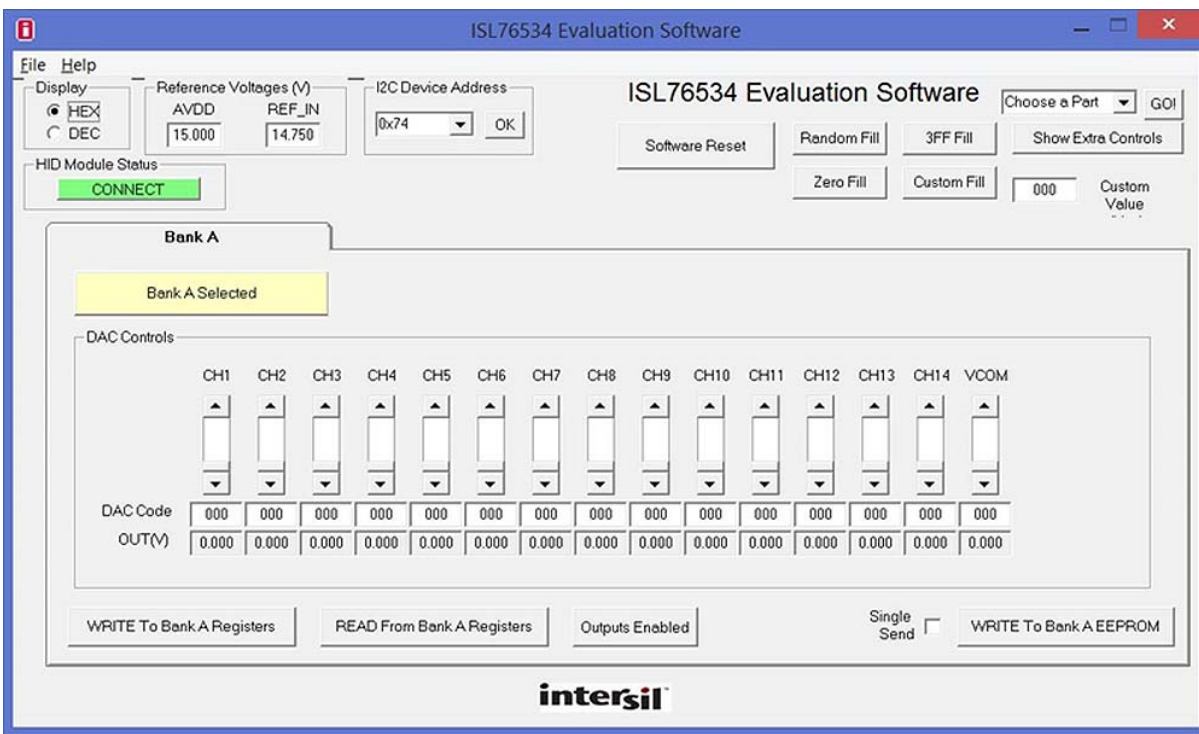

FIGURE 9. EVALUATION SOFTWARE WINDOW

Evaluation Software Troubleshooting

Verify that I²C signals can be detected on the SDA and SCL pins. If they cannot, check the connection between the evaluation board and the USB module. When trying to run the ISL76534 evaluation software, the occurrence of: "Run-time error number '429': Active X component can't create object" means that your computer does not have a sufficiently updated copy of Microsoft.NET Framework. Microsoft.NET Framework can be downloaded from the Microsoft web site at: <http://www.microsoft.com/net/download.aspx>. Any version from 2.0 and higher will work.

USB Driver Troubleshooting

The evaluation board software should be able to communicate with the evaluation board as soon as it is launched. If there is a communication problem, the dialog box shown in [Figure 10](#) is displayed. Click **Retry** to attempt to reconnect, or click **Cancel** to exit the application.

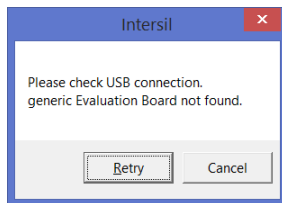

FIGURE 10. DEVICE NOT CONNECTED

After rebooting the PC, verify that the following files are in the following locations:

- ISL76534.exe in C:\Program Files\Intersil\ISL76534
- isilhid.dll in C:\Program Files\Intersil\ISL76534

If the dialog shown in [Figure 10](#) persists, open the Windows Control Panel. Double-click the **System** icon, select the **Hardware** tab, and then click **Device Manager**. The **Device Manager** window shown in [Figure 11](#) opens.

Click **Human Interface Devices** to expand the folder. You should see **HID-compliant Device** and an extra **USB Human Interface Device** subcategory when the USB module is plugged in. This indicates the driver is properly installed and is communicating with the evaluation board.

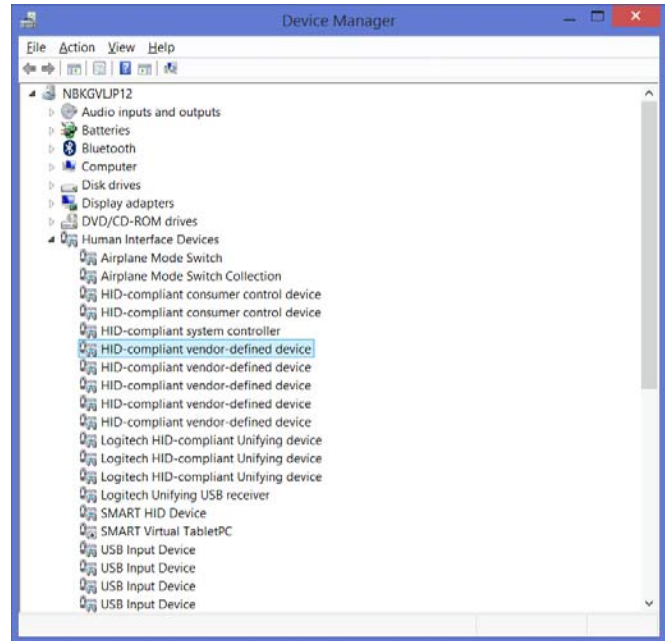

FIGURE 11. DEVICE MANAGER WINDOW

To verify that the new entries are actually the USB module, right-click on **HID-compliant Device** and in the drop-down menu, click **Properties**. The **HID-compliant device Properties** window opens ([Figure 12](#)). Click the **Details** tab. In the text window, you should see a string, "HID\VID_09AA and PID_2019" corresponding to the Vendor ID and Product ID of the USB module. The Vendor ID = 0x09AA, and the Product ID = 0x2019.

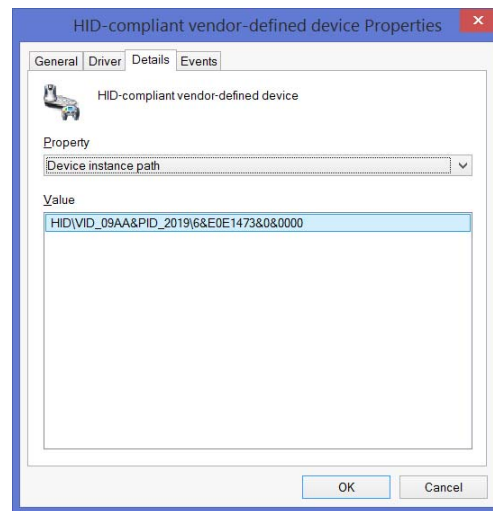

FIGURE 12. VERIFY VID = 09AA&PID = 2019

If the Vendor ID and Product ID are not visible, or if there are any error messages, try the following actions:

- Verify that the evaluation board has power and that the USB cable is connecting the evaluation board and the PC.
- Disconnect and then reconnect the USB cable. You should hear two tones from the PC speakers when the USB device is enumerated.
- Cycle the power to the board.
- Close all instances of the ISL76534 application and restart the software. Restart the PC if necessary.
- If none of this works, try installing the software on a different PC to isolate the cause to the PC versus the evaluation board.

PCB Layout Recommendations

Good Printed Circuit Board (PCB) layout is necessary for optimum performance. The following are recommendations to achieve optimum high frequency performance from your PCB.

- To optimize thermal performance, solder the ISL76534's exposed thermal pad to GND. PCB vias should be placed below the device's exposed thermal pad and connected to GND to transfer heat away from the device (see "General PowerPAD Design Considerations" in the [ISL76534](#) datasheet). If the thermal pad is not connected to GND then it should be electrically isolated.

- Maximize use of AC decoupled PCB layers. All signal I/O lines should be routed over continuous ground planes (i.e., no split planes or PCB gaps under these lines). Avoid vias in the signal I/O lines.
- When testing, use good quality connectors and cables, match cable types and keep cable lengths to a minimum.
- A minimum of two power supply decoupling capacitors are recommended (typically 4.7 μ F and 0.1 μ F) per supply and placed as close to the IC as possible. Avoid placing vias between the capacitor and the device because vias add unwanted inductance. Larger value capacitors can be placed farther away (see "[PCB Layouts](#)" starting on [page 11](#)).

For optimal thermal performance, use vias to distribute heat away from the IC and to a system power plane. Fill the thermal pad area with vias that are spaced 3x their radius (typically), center-to-center, from each other. The via diameters should be kept small, but they should be large enough to allow solder wicking during reflow. To optimize heat transfer efficiency, do not connect vias using "thermal relief" patterns. Vias should be directly connected to the plane with plated through-holes.

Connect all vias to the correct voltage potential (power plane) indicated in the datasheet. For the ISL76534, the thermal pad potential is ground (GND).

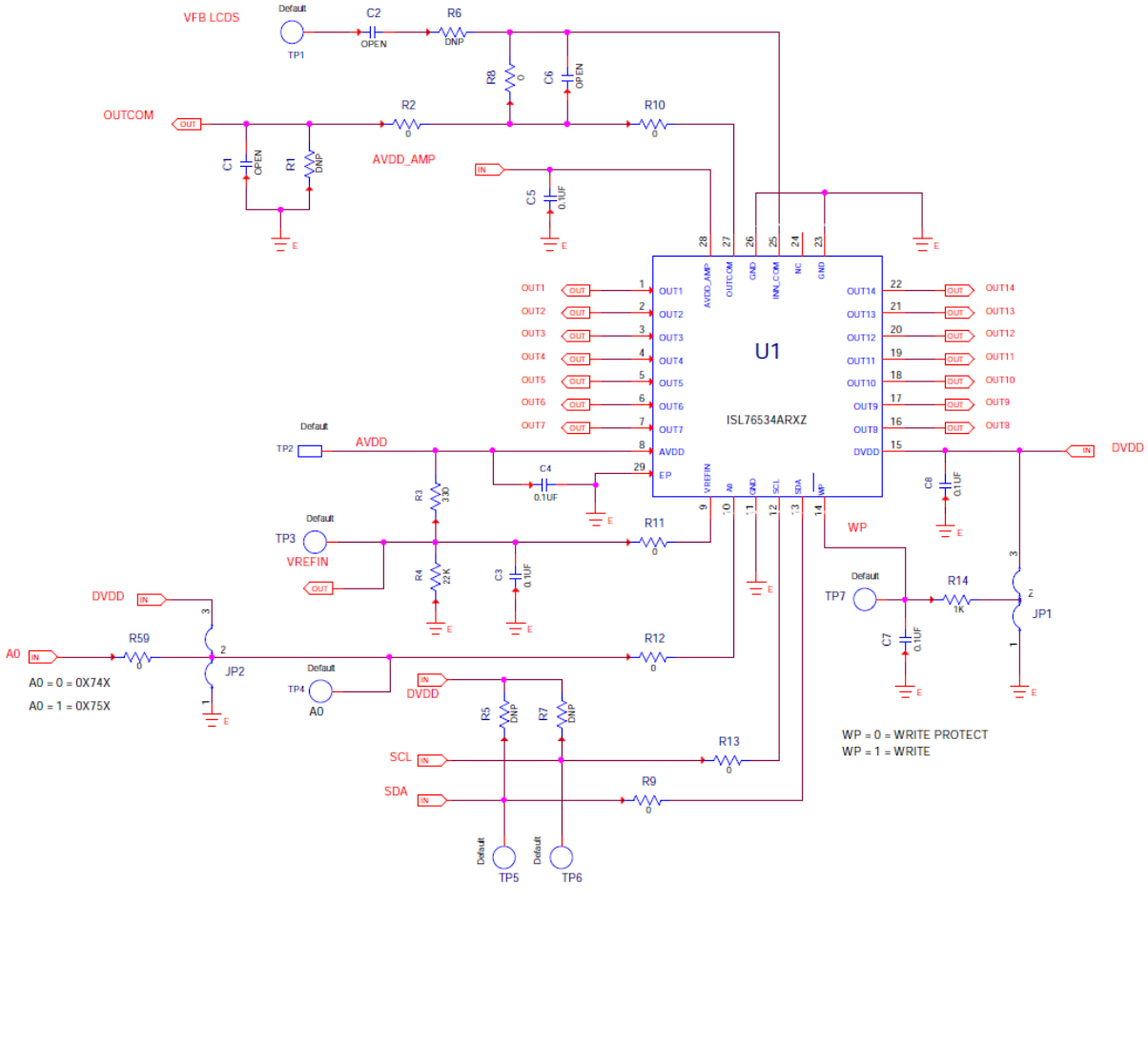
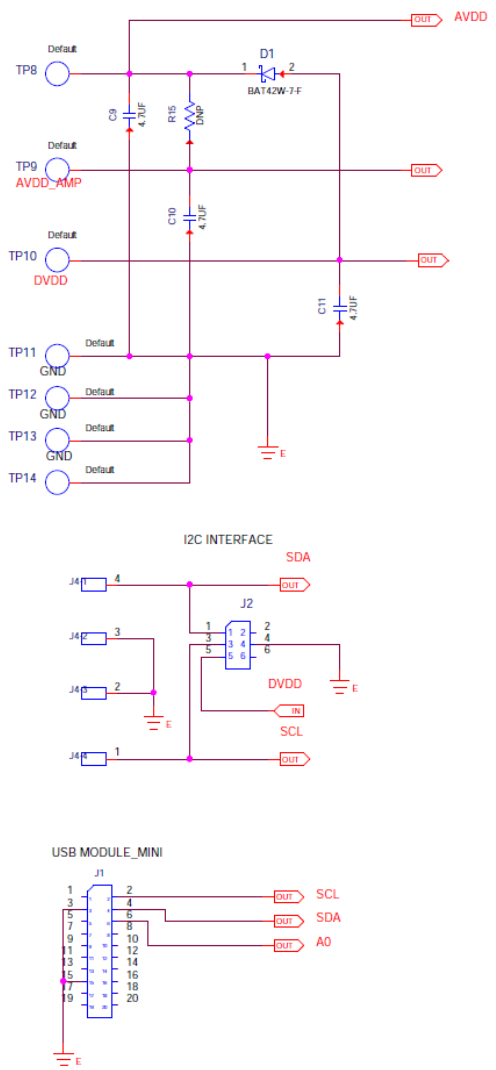
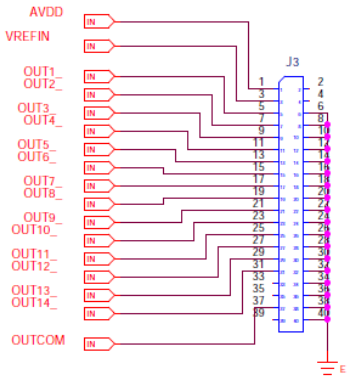

FIGURE 13. SCHEMATIC

Schematic





Schematic (Continued)

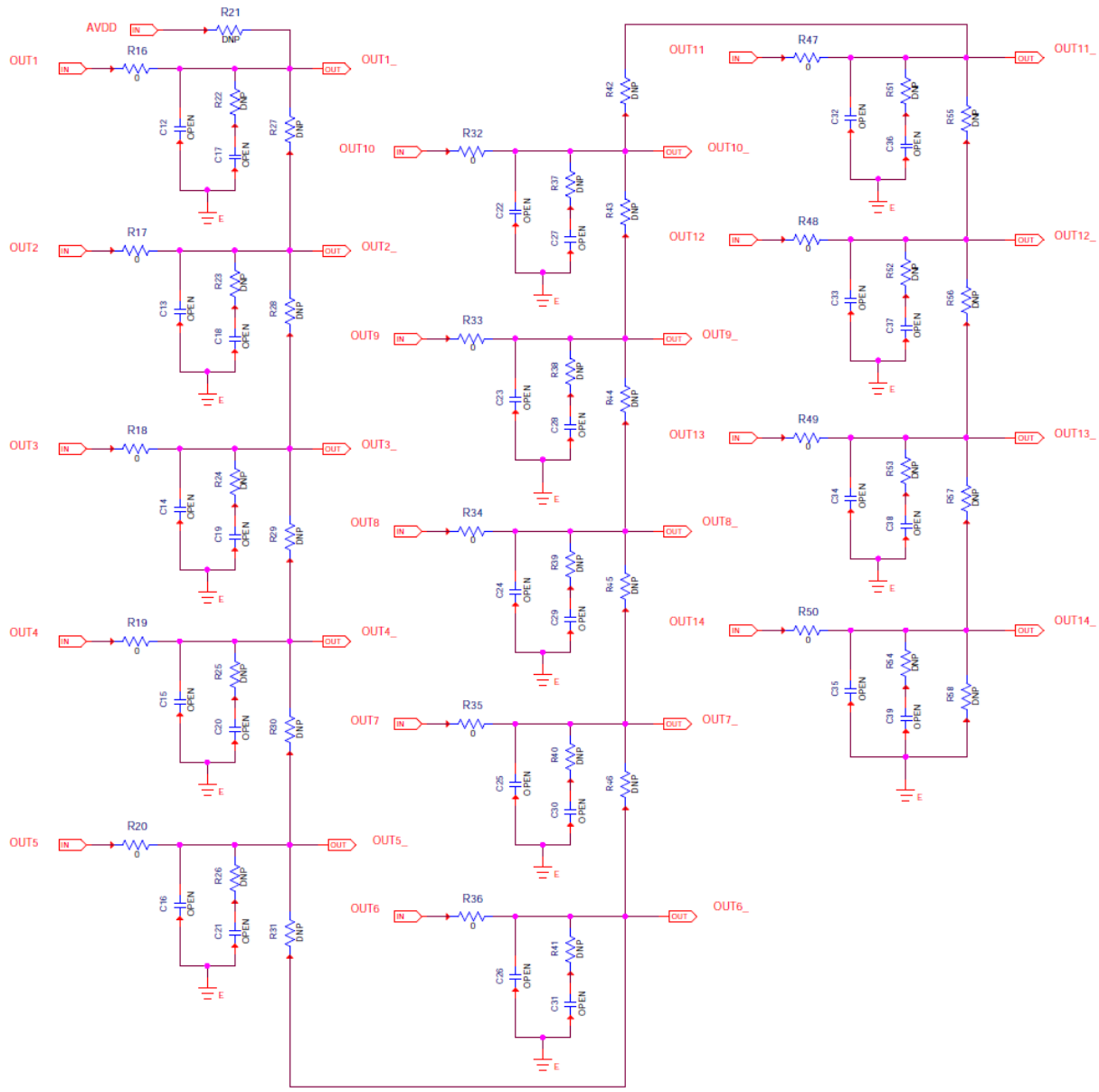

FIGURE 14. SCHEMATIC (Continued)

Bill of Materials

QTY	UNITS	REFERENCE DESIGNATOR	DESCRIPTION	MANUFACTURER	PART NUMBER
1	ea.	J4	(Do Not Populate), FOUR PIN FRICTION LOCK ASSEMBLY	MOLEX	22-11-2042
5	ea.	TP2, TP3, TP8-TP10	Miniature Red Test Point 0.100 Pad 0.040 Thole	KEYSTONE	5000
4	ea.	TP11-TP14	Miniature Black Test Point 0.100 Pad 0.040 Thole	KEYSTONE	5001
5	ea.	TP1, TP4-TP7	Miniature White Test Point 0.100 Pad 0.040 Thole	KEYSTONE	5002
1	ea.	D1	30V 200mA 200mW SCHOTTKY DIODE	Diodes Inc	BAT42W-7-F
3	ea.	C9-C11	4.7 μ F, 35V, 10%, Ceramic Cap, X7R	TDK	CGA4J1X7R1V475K125AE
5	ea.	C3-C5, C7, C8	0.1 μ F, 50V, 10% Multilayer Cap	GENERIC	H1045-00104-50V10
31	ea.	C1, C2, C6, C12-C39	(Do Not Populate), Multilayer Cap	GENERIC	H1045-OPEN
34	ea.	R1, R5-R7, R15, R21-R31, R37-R46, R51-R58	(Do Not Populate), Metal Film Chip Resistor	GENERIC	H2505-DNP-DNP-1
22	ea.	R2, R8-R13, R16-R20, R32-R36, R47-R50, R59	(Do Not Populate), Thick Film Chip Resistor	GENERIC	H2511-00R00-1/16W1
1	ea.	R14	1k Ω , 1%, 62.5mW, Thick Film Chip Resistor	GENERIC	H2511-01001-1/16W1
1	ea.	U1	15Ch Programmable Gamma Buffer	INTERSIL	ISL76534ARXZ
2	ea.	JP1, JP2	Three Pin Jumper	GENERIC	JUMPER-3-100
1	ea.	J1	10/20 Pin Dual Row Header 0.5x0.5	HARWIN	M50-3901042
1	ea.	R4	22k Ω , 1%, 62.5mW, Thick Film Chip Resistor	Rohm	MCR03ERTF2202
1	ea.	R3	330 Ω , 1%, 62.5mW, Thick Film Chip Resistor	Rohm	MCR03ERTF3300
1	ea.	J2	6 Pin Male Right Angle Header 2.54mmx2.54mm (0.100)	SAMTEC	TSW-103-08-T-D-RA
1	ea.	J3	40 Pin Header 2.54mmx2.54mm (0.100)	SAMTEC	TSW-40

PCB Layouts

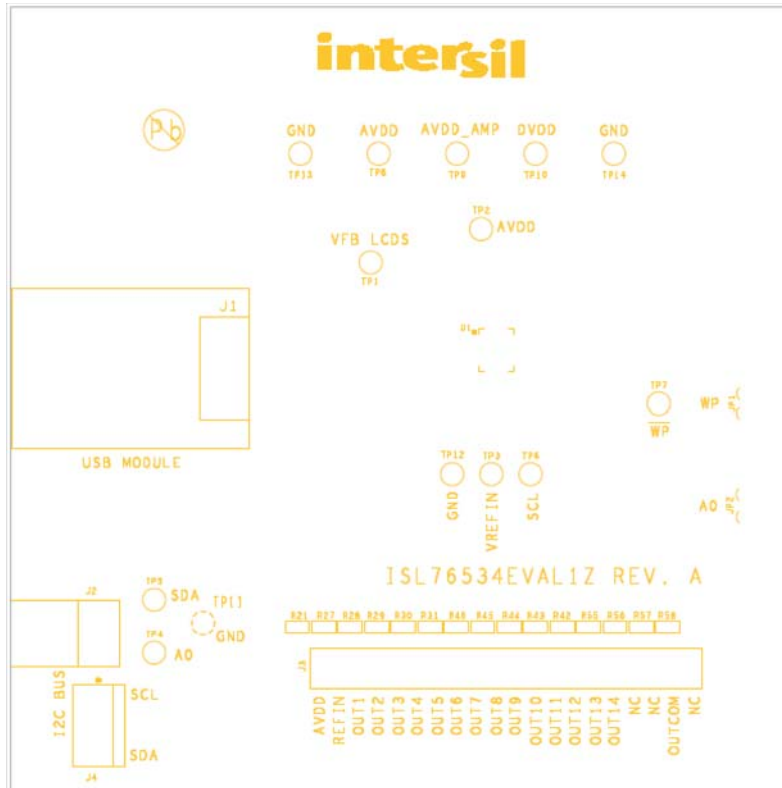

FIGURE 15. SILK LAYER TOP

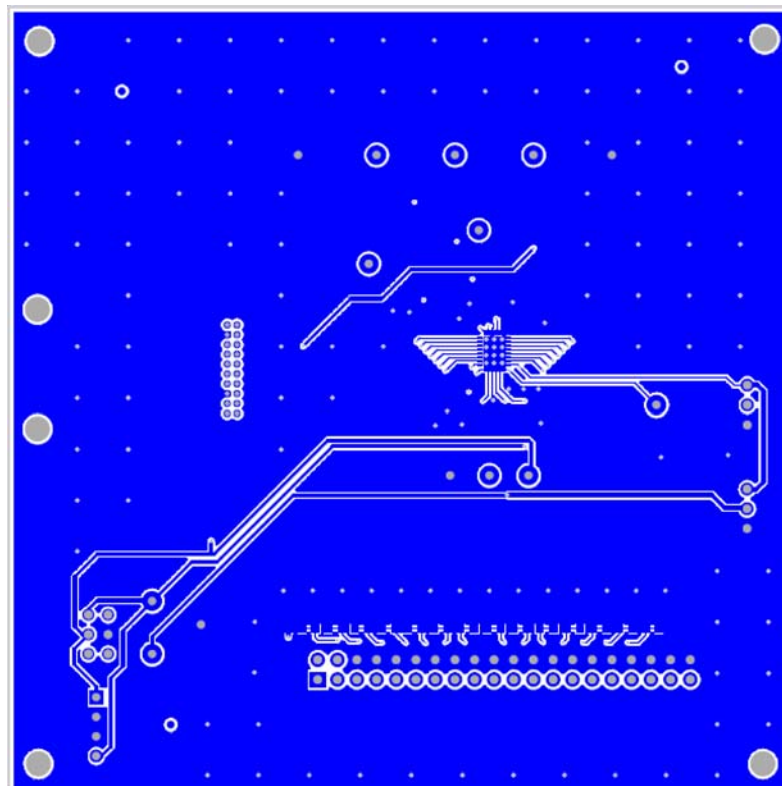

FIGURE 16. TOP LAYER COMPONENT SIDE

PCB Layouts (Continued)

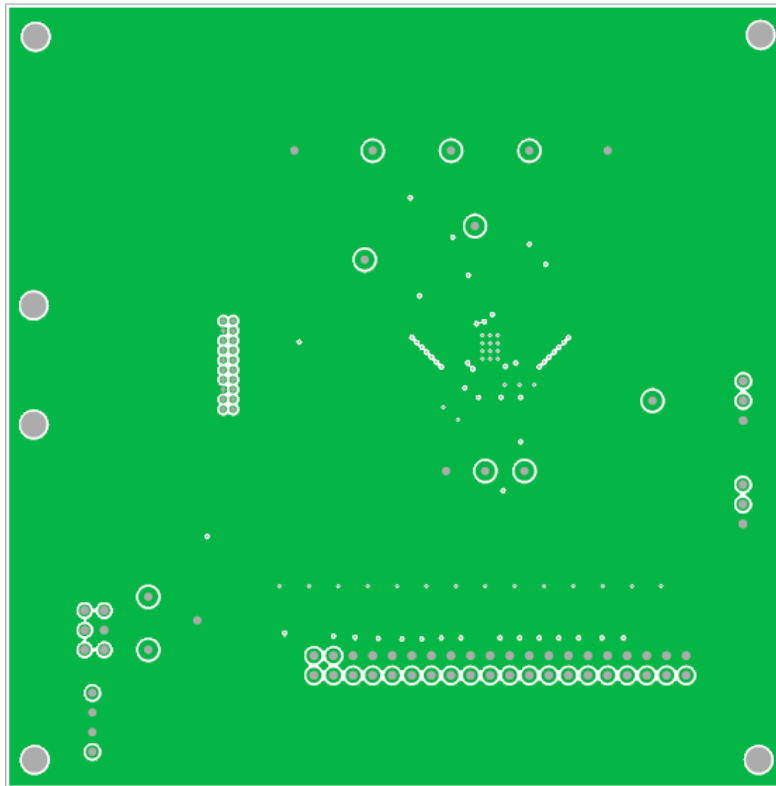

FIGURE 17. INTERNAL (LAYER 2)

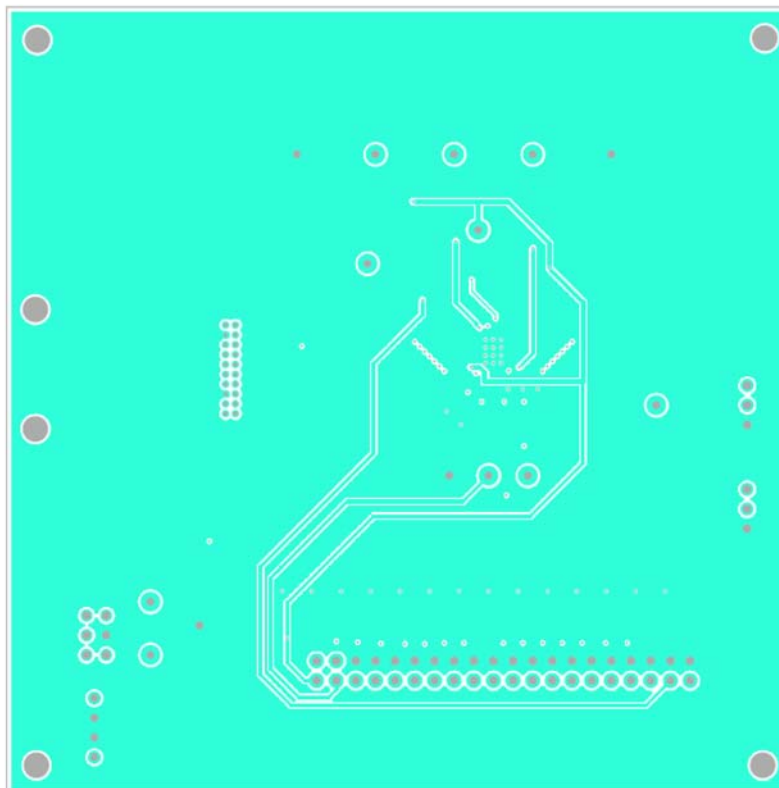

FIGURE 18. INTERNAL (LAYER 3)

PCB Layouts (Continued)

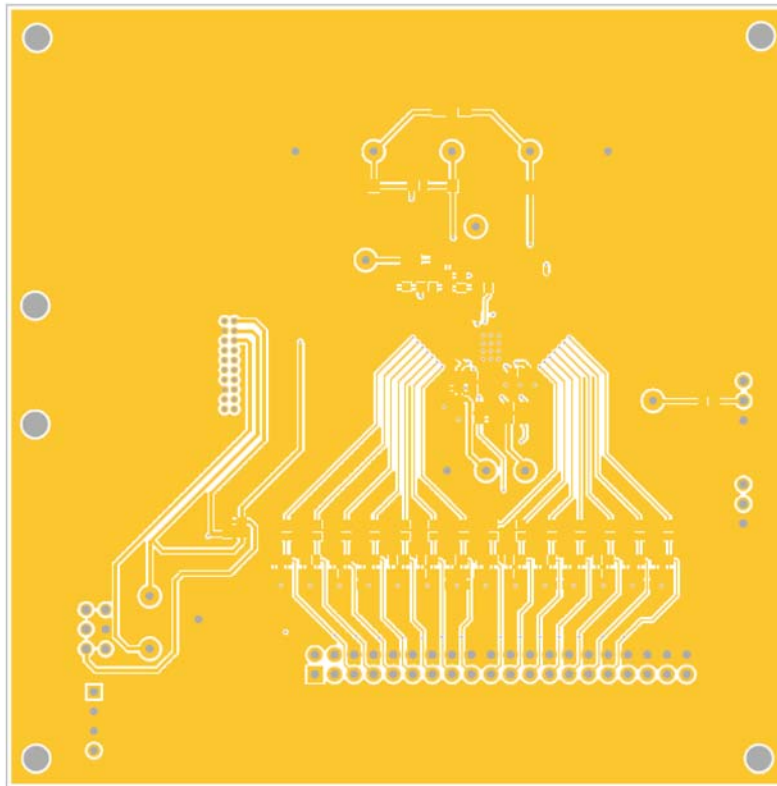

FIGURE 19. BOTTOM LAYER SOLDER SIDE

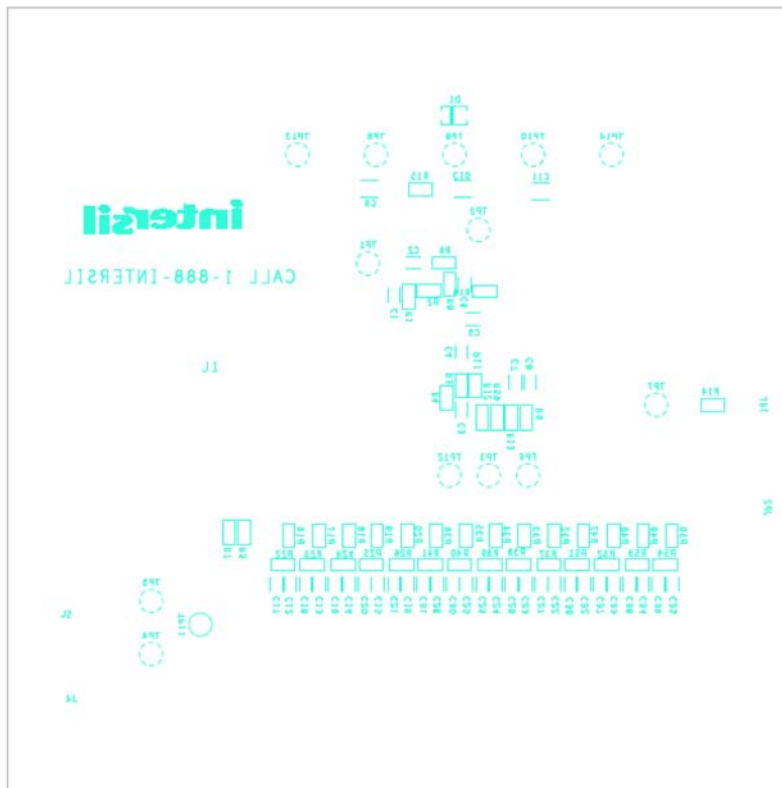

FIGURE 20. SILKSCREEN BOTTOM

Typical Performance Curves

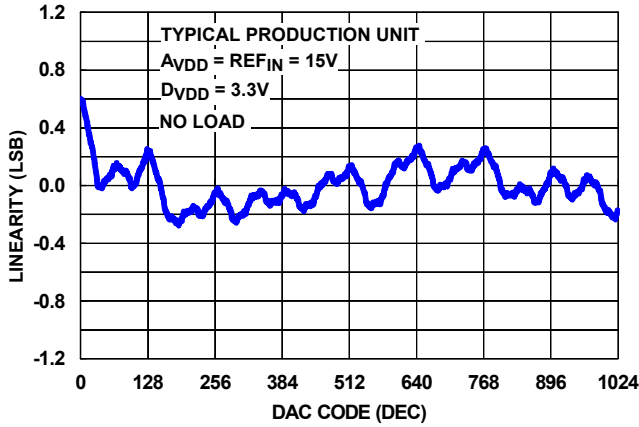

FIGURE 21. DAC1-DAC15 INL ($REF_{IN} = A_{VDD} = 15V$) AT $+25^{\circ}C$

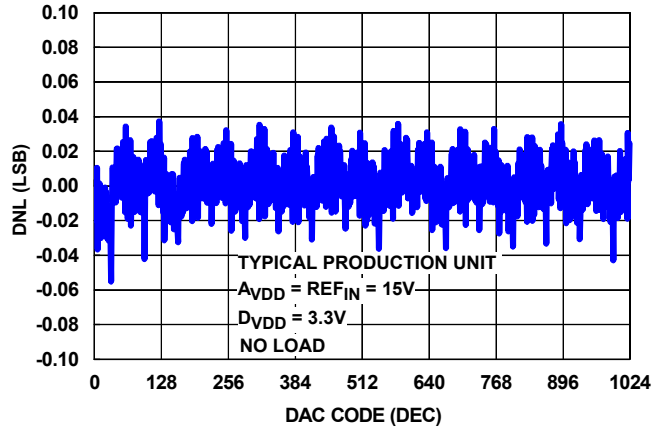

FIGURE 22. DAC1-DAC15 DNL ($REF_{IN} = A_{VDD} = 15V$) AT $+25^{\circ}C$

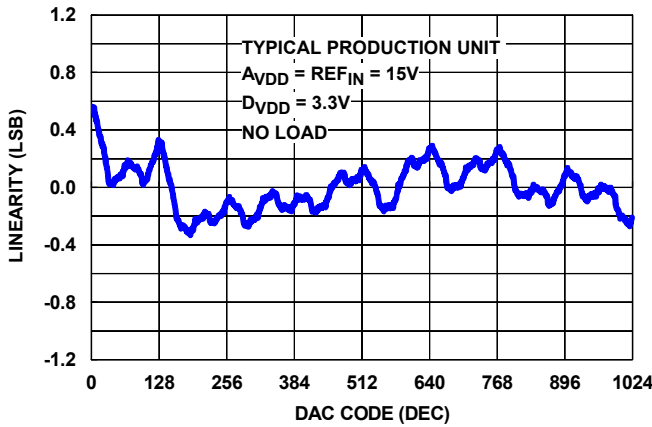

FIGURE 23. DAC1-DAC15 TYPICAL INL ($REF_{IN} = A_{VDD} = 15V$) AT $-40^{\circ}C$

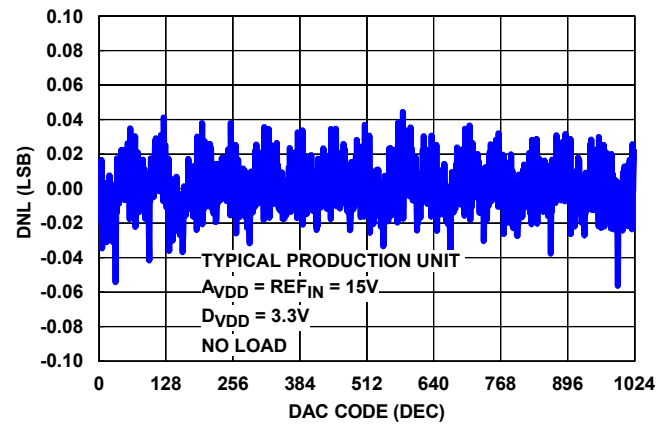

FIGURE 24. DAC1-DAC15 TYPICAL DNL ($REF_{IN} = A_{VDD} = 15V$) AT $-40^{\circ}C$

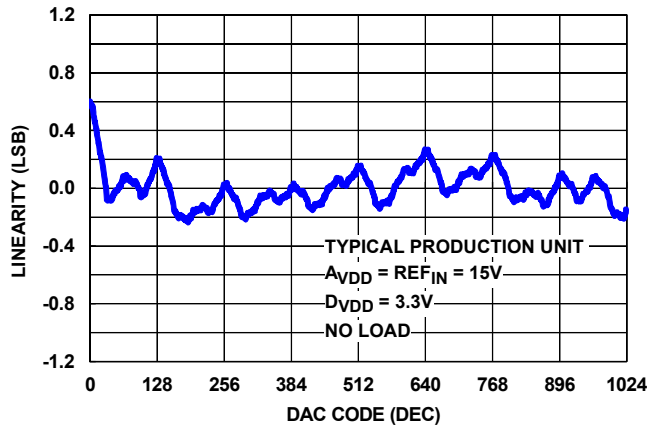

FIGURE 25. DAC1-DAC15 INL ($REF_{IN} = A_{VDD} = 15V$) AT $+105^{\circ}C$

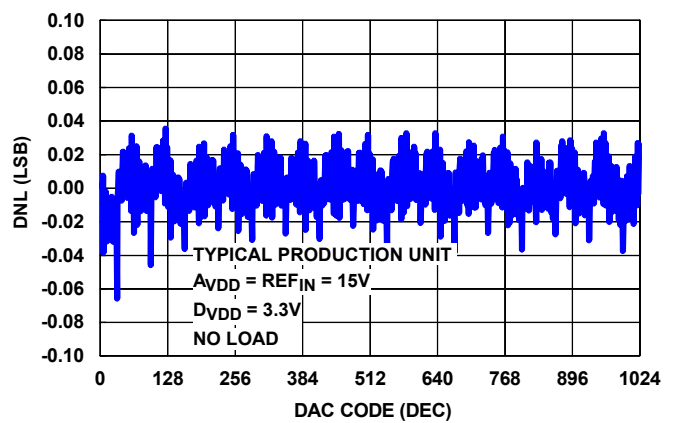

FIGURE 26. DAC1-DAC15 DNL ($REF_{IN} = A_{VDD} = 15V$) AT $+105^{\circ}C$

Notice

1. Descriptions of circuits, software and other related information in this document are provided only to illustrate the operation of semiconductor products and application examples. You are fully responsible for the incorporation or any other use of the circuits, software, and information in the design of your product or system. Renesas Electronics disclaims any and all liability for any losses and damages incurred by you or third parties arising from the use of these circuits, software, or information.
2. Renesas Electronics hereby expressly disclaims any warranties against and liability for infringement or any other claims involving patents, copyrights, or other intellectual property rights of third parties, by or arising from the use of Renesas Electronics products or technical information described in this document, including but not limited to, the product data, drawings, charts, programs, algorithms, and application examples.
3. No license, express, implied or otherwise, is granted hereby under any patents, copyrights or other intellectual property rights of Renesas Electronics or others.
4. You shall not alter, modify, copy, or reverse engineer any Renesas Electronics product, whether in whole or in part. Renesas Electronics disclaims any and all liability for any losses or damages incurred by you or third parties arising from such alteration, modification, copying or reverse engineering.
5. Renesas Electronics products are classified according to the following two quality grades: "Standard" and "High Quality". The intended applications for each Renesas Electronics product depends on the product's quality grade, as indicated below.
"Standard": Computers; office equipment; communications equipment; test and measurement equipment; audio and visual equipment; home electronic appliances; machine tools; personal electronic equipment; industrial robots; etc.
"High Quality": Transportation equipment (automobiles, trains, ships, etc.); traffic control (traffic lights); large-scale communication equipment; key financial terminal systems; safety control equipment; etc.
Unless expressly designated as a high reliability product or a product for harsh environments in a Renesas Electronics data sheet or other Renesas Electronics document, Renesas Electronics products are not intended or authorized for use in products or systems that may pose a direct threat to human life or bodily injury (artificial life support devices or systems; surgical implantations; etc.), or may cause serious property damage (space system; undersea repeaters; nuclear power control systems; aircraft control systems; key plant systems; military equipment; etc.). Renesas Electronics disclaims any and all liability for any damages or losses incurred by you or any third parties arising from the use of any Renesas Electronics product that is inconsistent with any Renesas Electronics data sheet, user's manual or other Renesas Electronics document.
6. When using Renesas Electronics products, refer to the latest product information (data sheets, user's manuals, application notes, "General Notes for Handling and Using Semiconductor Devices" in the reliability handbook, etc.), and ensure that usage conditions are within the ranges specified by Renesas Electronics with respect to maximum ratings, operating power supply voltage range, heat dissipation characteristics, installation, etc. Renesas Electronics disclaims any and all liability for any malfunctions, failure or accident arising out of the use of Renesas Electronics products outside of such specified ranges.
7. Although Renesas Electronics endeavors to improve the quality and reliability of Renesas Electronics products, semiconductor products have specific characteristics, such as the occurrence of failure at a certain rate and malfunctions under certain use conditions. Unless designated as a high reliability product or a product for harsh environments in a Renesas Electronics data sheet or other Renesas Electronics document, Renesas Electronics products are not subject to radiation resistance design. You are responsible for implementing safety measures to guard against the possibility of bodily injury, injury or damage caused by fire, and/or danger to the public in the event of a failure or malfunction of Renesas Electronics products, such as safety design for hardware and software, including but not limited to redundancy, fire control and malfunction prevention, appropriate treatment for aging degradation or any other appropriate measures. Because the evaluation of microcomputer software alone is very difficult and impractical, you are responsible for evaluating the safety of the final products or systems manufactured by you.
8. Please contact a Renesas Electronics sales office for details as to environmental matters such as the environmental compatibility of each Renesas Electronics product. You are responsible for carefully and sufficiently investigating applicable laws and regulations that regulate the inclusion or use of controlled substances, including without limitation, the EU RoHS Directive, and using Renesas Electronics products in compliance with all these applicable laws and regulations. Renesas Electronics disclaims any and all liability for damages or losses occurring as a result of your noncompliance with applicable laws and regulations.
9. Renesas Electronics products and technologies shall not be used for or incorporated into any products or systems whose manufacture, use, or sale is prohibited under any applicable domestic or foreign laws or regulations. You shall comply with any applicable export control laws and regulations promulgated and administered by the governments of any countries asserting jurisdiction over the parties or transactions.
10. It is the responsibility of the buyer or distributor of Renesas Electronics products, or any other party who distributes, disposes of, or otherwise sells or transfers the product to a third party, to notify such third party in advance of the contents and conditions set forth in this document.
11. This document shall not be reprinted, reproduced or duplicated in any form, in whole or in part, without prior written consent of Renesas Electronics.
12. Please contact a Renesas Electronics sales office if you have any questions regarding the information contained in this document or Renesas Electronics products.
(Note 1) "Renesas Electronics" as used in this document means Renesas Electronics Corporation and also includes its directly or indirectly controlled subsidiaries.
(Note 2) "Renesas Electronics product(s)" means any product developed or manufactured by or for Renesas Electronics.

(Rev.4.0-1 November 2017)



SALES OFFICES

Renesas Electronics Corporation

<http://www.renesas.com>

Refer to "<http://www.renesas.com/>" for the latest and detailed information.

Renesas Electronics America Inc.
1001 Murphy Ranch Road, Milpitas, CA 95035, U.S.A.
Tel: +1-408-432-8888, Fax: +1-408-434-5351

Renesas Electronics Canada Limited
9251 Yonge Street, Suite 8309 Richmond Hill, Ontario Canada L4C 9T3
Tel: +1-905-237-2004

Renesas Electronics Europe Limited
Dukes Meadow, Millboard Road, Bourne End, Buckinghamshire, SL8 5FH, U.K.
Tel: +44-1628-651-700, Fax: +44-1628-651-804

Renesas Electronics Europe GmbH
Arcadiastrasse 10, 40472 Düsseldorf, Germany
Tel: +49-211-6503-0, Fax: +49-211-6503-1327

Renesas Electronics (China) Co., Ltd.
Room 1709 Quantum Plaza, No.27 ZhichunLu, Haidian District, Beijing, 100191 P. R. China
Tel: +86-10-8235-1155, Fax: +86-10-8235-7679

Renesas Electronics (Shanghai) Co., Ltd.
Unit 301, Tower A, Central Towers, 555 Langao Road, Putuo District, Shanghai, 200333 P. R. China
Tel: +86-21-2226-0888, Fax: +86-21-2226-0999

Renesas Electronics Hong Kong Limited
Unit 1601-1611, 16/F., Tower 2, Grand Century Place, 193 Prince Edward Road West, Mongkok, Kowloon, Hong Kong
Tel: +852-2265-6688, Fax: +852-2886-9022

Renesas Electronics Taiwan Co., Ltd.
13F, No. 363, Fu Shing North Road, Taipei 10543, Taiwan
Tel: +886-2-8175-9600, Fax: +886-2-8175-9670

Renesas Electronics Singapore Pte. Ltd.
80 Bendemeer Road, Unit #06-02 Hyflux Innovation Centre, Singapore 339949
Tel: +65-6213-0200, Fax: +65-6213-0300

Renesas Electronics Malaysia Sdn.Bhd.
Unit 1207, Block B, Menara Amcorp, Amcorp Trade Centre, No. 18, Jln Persiaran Barat, 46050 Petaling Jaya, Selangor Darul Ehsan, Malaysia
Tel: +60-3-7955-9390, Fax: +60-3-7955-9510

Renesas Electronics India Pvt. Ltd.
No.777C, 100 Feet Road, HAL 2nd Stage, Indiranagar, Bangalore 560 038, India
Tel: +91-80-67208700, Fax: +91-80-67208777

Renesas Electronics Korea Co., Ltd.
17F, KAMCO Yangjae Tower, 262, Gangnam-daero, Gangnam-gu, Seoul, 06265 Korea
Tel: +82-2-558-3737, Fax: +82-2-558-5338