

RTKA489206DK0000BU

Evaluation Kit and GUI

This document demonstrates basic operations of the GUI and RAA489206 Evaluation Kit. Use this document in the sequence it was written, each section assumes the previous section was completed. See the [RAA489206](#) datasheet for detailed information.

Software

The RAA489206 Evaluation Board GUI Code zip file must be downloaded from the Documentation and Downloads section of the [RTKA489206DK0000BU](#) board page. The RAA489206 GUI is built on top of Excel using Visual Basic for Applications (VBA 1.00). It is designed to allow you to perform detailed evaluation of the RAA489206 and also includes a simplified demonstration GUI.

Kit Contents

The RAA489206 Evaluation Kit consists of the following components:

- RTKA489206DE0000BU - RAA489206 eval board
- ISO-DONGLE-EV1Z - RAA489206 communications dongle with USB cable
- BMS-PS-CELL16Z - A 16-cell resistor ladder board

Features

- High hot plug rating: 62V
- V_{CELL} accuracy: $\pm 5\text{mV}$
- $V_{BAT} = 59\text{V}$
- I_{PACK} accuracy: $\pm 0.2\%$
- 16-bit V_{CELL} and I_{PACK} measurements
- High-side CFET/DFET drivers
- Charge/Load wakeup detection circuitry
- 4-pin GPIO port
- Integrated 3.3V regulator
- Supports I²C and SPI communications

Recommended Equipment

The following equipment is also needed to complete an evaluation of the device:

- Power supply (or battery pack)
- Current meter
- Voltmeter
- Oscilloscope

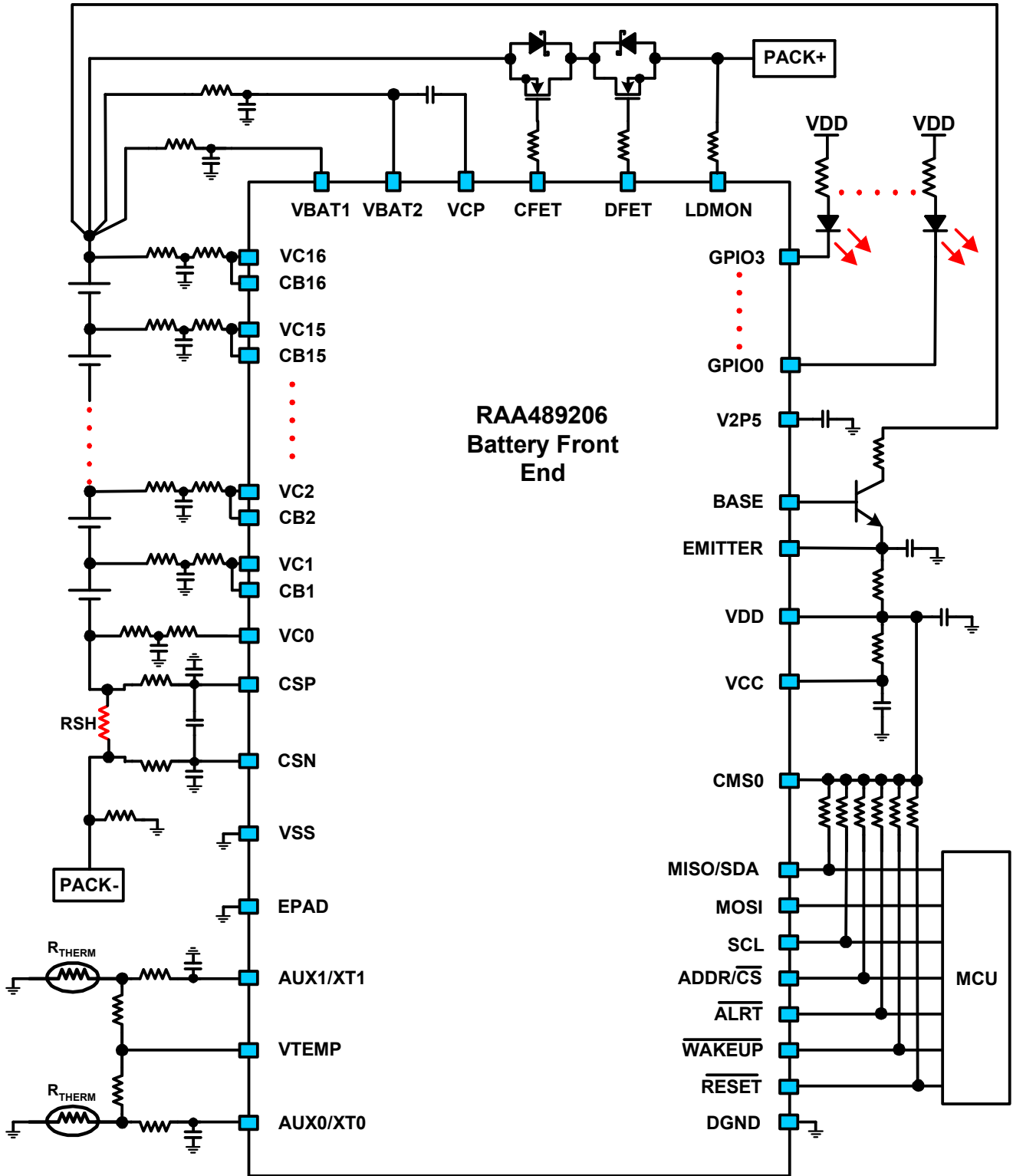

Figure 1. RAA489206 Typical Application

Contents

1. Functional Description	5
1.1 Evaluation Board	5
1.2 Evaluation Board LEDs	6
1.3 Evaluation Board Communications Switches	7
1.4 Communications Dongle	7
1.5 Resistor Ladder	8
1.6 Power Supply	8
1.7 Current Meter	9
1.8 Voltmeter	9
1.9 Oscilloscope	9
1.10 BMS Assembly	9
1.11 High Current Loads	10
2. RAA489206 GUI Start	10
2.1 Power Supply	11
2.2 Connect	11
2.3 Initialization	12
2.3.1 Read Settings	12
2.3.2 Basic Init	12
3. SCAN Mode	13
3.1 Busy Bit	14
3.2 Single System Scans	14
3.2.1 Measure Enable Bits	14
3.3 Continuous System Scans	15
3.4 Low Power Timer	16
4. IDLE Mode	17
4.1 VCell Trigger	17
4.1.1 Cell Select	18
4.1.2 VCell Fault Detection	19
4.2 IPack Trigger	20
4.2.1 IPack Fault Detection	20
4.3 VREG Trigger	23
4.3.1 VCC Min Threshold	23
4.3.2 IReg OC1 Threshold	23
4.3.3 IReg OC2 Threshold	24
4.4 VBAT/ITEMP Triggers	24
4.4.1 VBAT1 OV Threshold	25
4.4.2 VBAT1 UV Threshold	25
4.4.3 Internal Temperature	26
4.5 COMM Timeout	27
5. LOW POWER Mode	28
5.1 Strong/Weak Regulator	28
6. SHIP Mode	29
6.1 Strong/Weak Regulator	29
6.2 Wakeup	30
7. Demonstration GUI	30

7.1	Launching the Demo GUI	30
7.2	Initializing the Demo GUI	31
7.3	Demo Single Scan	31
7.4	Demo Continuous Scan	31
7.5	Demo Graphing	32
7.6	Demo Threshold Modification	33
7.7	Demo Fault Indicators/Clearing	33
7.8	Exiting the Demo GUI	34
8.	Board Design	35
8.1	Schematic Drawings	35
8.2	RTKA489206DE0000BU Bill of Materials	37
9.	Ordering Information	40
10.	Revision History	40
	Appendix A	41

1. Functional Description

1.1 Evaluation Board

The RAA489206 evaluation board (Figure 2) as shipped from stock is set up for 16 cells with external cell balancing components selected to provide ~500mA of cell balancing current.

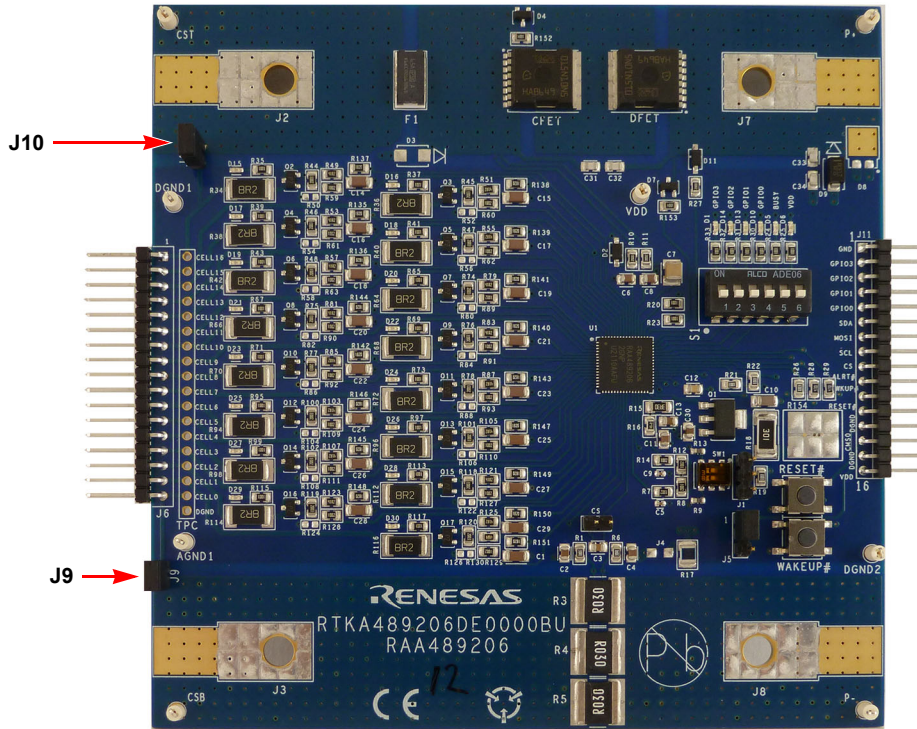

Figure 2. RAA489206 Evaluation Board (Top)

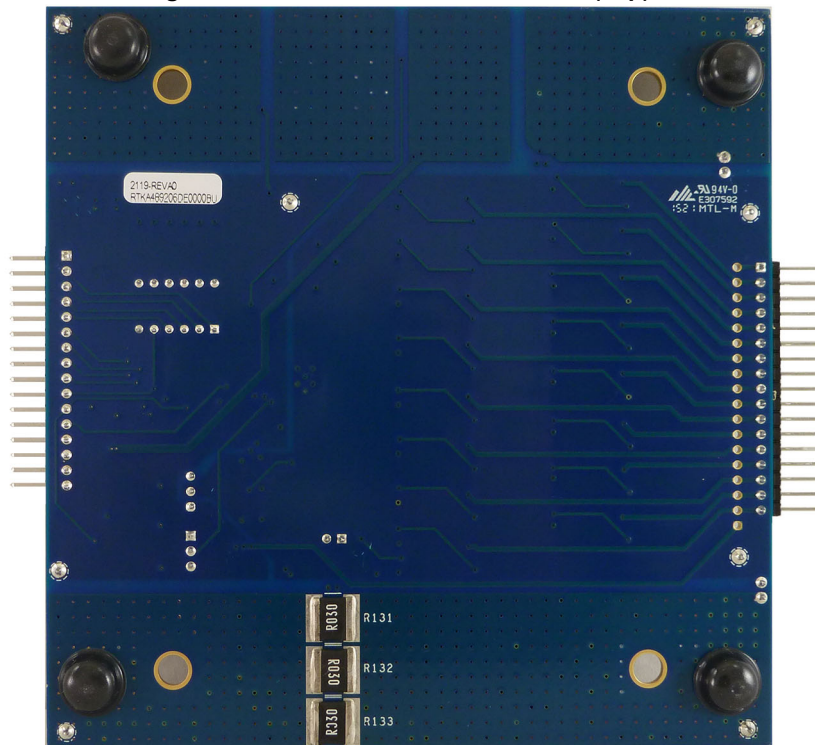

Figure 3. RAA489206 Evaluation Board (Bottom)

Supply current can be monitored by connecting the current meter across J9 or J10. These jumpers MUST be in place if a current meter is not. Exceptions are listed in [High Current Loads](#).

The board can be configured for fewer cells by installing jumpers on connector TPC, or across parts of J3 on the resistor ladder board (see [Resistor Ladder](#)).

A complete schematic for the evaluation board is available here: [Schematic Drawings](#).

The cell balancing current can be adjusted by changing resistors R34, R36, R38, R40, R42, R64, R66, R68, R70, R72, R94, R96, R98, R112, R114, and R116. VC1 external cell balancing circuitry is shown in [Figure 4](#) with R114 in the lower left.

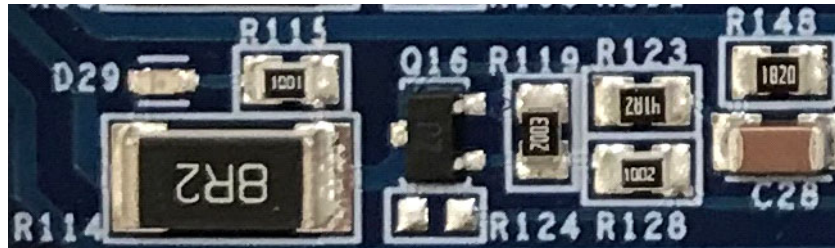

Figure 4. VC1 External Cell Balancing Circuitry

1.2 Evaluation Board LEDs

The evaluation board has six LEDs, four on the GPIO pins, one for $\overline{\text{ALRT}}$ and one for VDD. S1 positions 1-4 are in line with the GPIO pins, position 5 is $\overline{\text{ALRT}}$ and position 6 is VDD. In the OFF position, as shown in [Figure 5](#), the LEDs and their pull-up resistors to VDD are disconnected from the RAA489206 pins. The OFF position allows the RAA489206 supply current to be measured without the external LED current for demonstration and/or verification of datasheet limits.

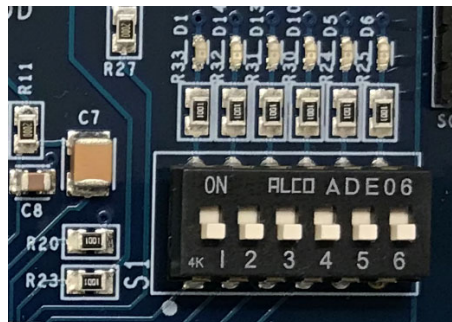

Figure 5. LEDs

Slide S1 positions 5 ($\overline{\text{ALRT}}$ LED D5) and 6 (VDD LED D6) up to the **ON** setting. D6 should light up when the RAA489206 is powered.

1.3 Evaluation Board Communications Switches

The communication protocol of the RAA489206 is determined by the connection of pin CMS0 (see datasheet). The selection is configured by the jumper J5 in the lower right corner of the evaluation board. With a jumper connecting Pin 2 to Pin 3, the device is configured for I²C only. By default, the GUI configures the dongle for SPI communication. The jumper should be removed (as shown in Figure 6) for proper operation using the GUI and dongle supplied with the evaluation kit. It is important to verify J5 is open, otherwise the GUI may not connect to the device. With the jumper removed the GUI can configure the dongle and RAA489206 to use any of the two available protocols after the connect function is complete. J5 enables connections with other controllers.

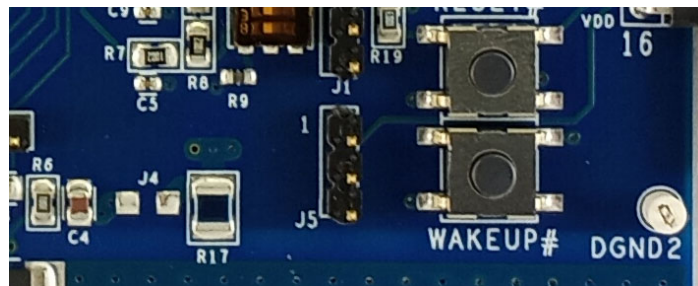

Figure 6. Communication Select Jumper

1.4 Communications Dongle

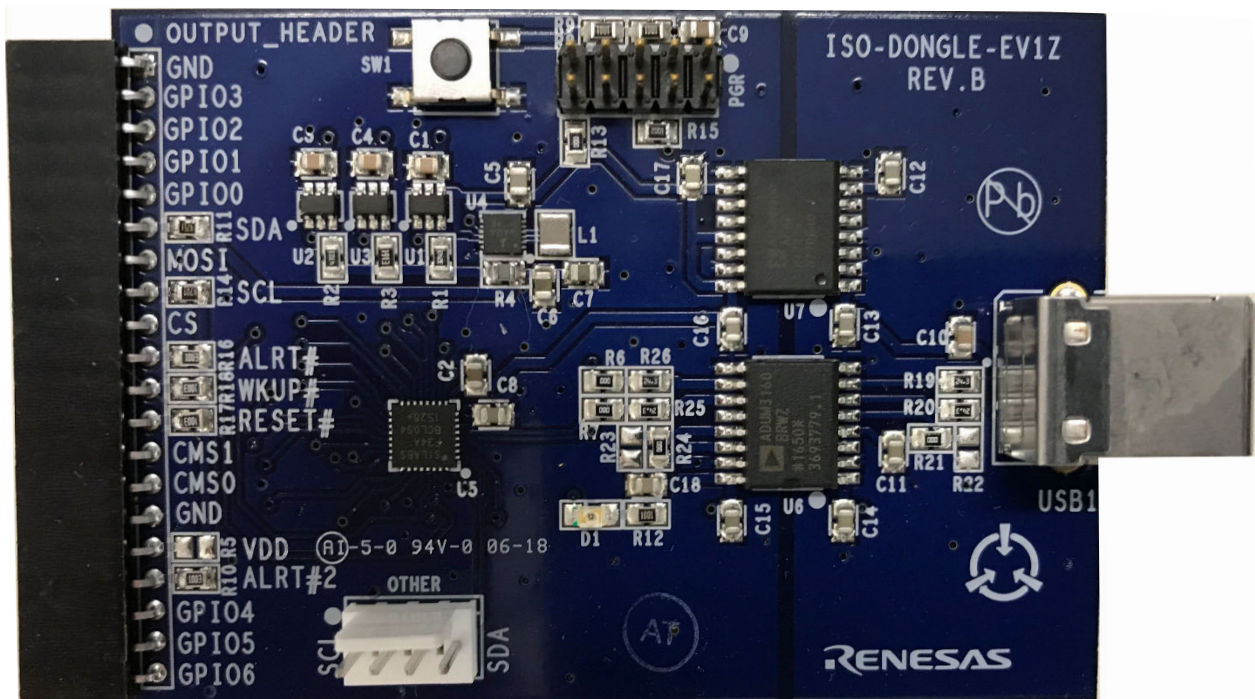

Figure 7. ISO-DONGLE-EV1Z Communications Dongle

The communications dongle, shown in Figure 7, is a board that isolates the RAA489206 evaluation board assembly ground from the PC and workbench grounds. Most Battery Management Systems (BMS) operate isolated from earth ground. **IMPORTANT:** When an oscilloscope probe ground is connected to the assembly it can provide a path to earth ground, which in severe cases can reset the RAA489206. Any earth ground connection should be made before the board is powered to avoid an unintended reset.

The dongle enables SPI and I²C communications with the RAA489206. Connect the dongle to the PC using the provided USB cable.

Using the GUI the dongle can be configured to drive or read the RAA489206 GPIO pins.

Under some circumstances the dongle draws current from the RAA489206 evaluation board, it might be necessary to disconnect the dongle from the evaluation board if attempting to measure only the current drawn by the RAA489206. Both the evaluation board and the dongle come with pull up resistors on the SDA and SCL pins. These should be removed from the evaluation board (R28, R29) for best performance.

1.5 Resistor Ladder

A resistor ladder board is used to mimic a cell stack (limited) if a battery pack is not available. AC or heavy load currents and cell balancing cause voltage fluctuations when using a resistor ladder that would not occur with batteries.

Connector J3, yellow arrow in [Figure 8](#), can be used to short out center cells for the evaluation of systems with fewer than 16 cells. See the Reduced Cell Count section of the RAA489206 datasheet for details.

Each CELL of the resistor ladder consists of three 300Ω resistors in parallel resulting in 100Ω per cell. At a typical operating voltage of 48V with 16 100Ω cells in series ~30mA is consumed.

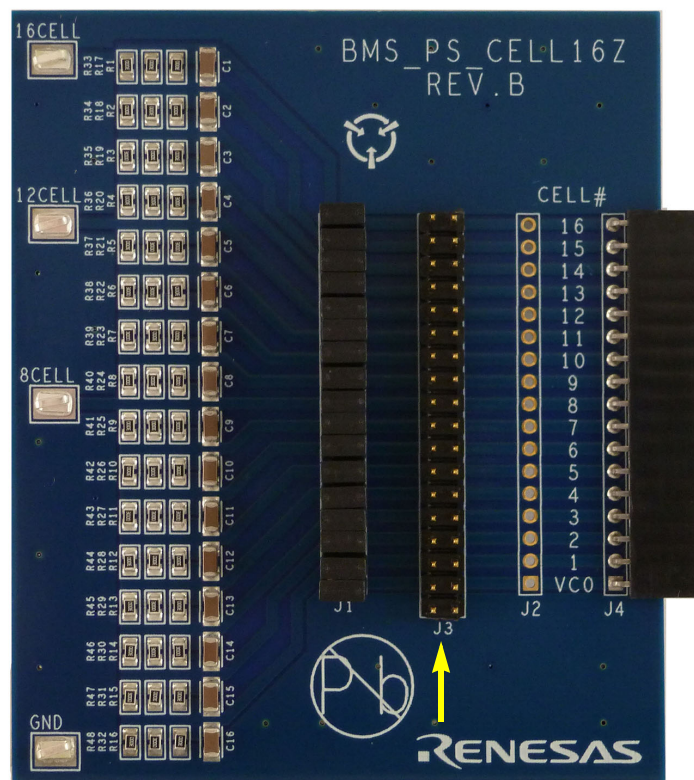

Figure 8. Resistor Ladder Board

1.6 Power Supply

If a battery pack is not available, the combination of a power supply and a resistor ladder is used. The power supply must be selected so that it can supply the ladder, RAA489206 evaluation board, and load currents at the required voltage without current limiting.

With the power supply output disabled, connect the negative terminal to the GND clip and the positive terminal to the 16CELL clip on the resistor ladder board.

Set the power supply output voltage to 48V, but keep the output disabled. If using a reduced number of cells, set to the appropriate voltage. Do not exceed 59V VBAT or 4.8V per cell, whichever is lower. **Note:** The maximum recommended VBAT value may be higher, for specifications see the datasheet.

1.7 Current Meter

The current meter is used to measure the current consumed by the RAA489206 Evaluation Board and/or load. If a multimeter is used, make certain it is connected and set to measure current. The current meter should be connected in place of **either** jumper J9 **or** J10 on the evaluation board. The text in the following sections assumes this meter is installed at J10. The jumpers must be installed except in special cases, such as the insertion of the current meter or as described in [High Current Loads](#). The meter should be connected before the power supply output is enabled, or a battery pack is connected to the evaluation board.

1.8 Voltmeter

The voltmeter measures various voltages of interest on the RAA489206 BMS assembly. The recommended startup connection is Pack+ (J7) vs Pack- (J8).

1.9 Oscilloscope

The Oscilloscope captures communications, analog and digital signals associated with the RAA489206, as needed.

1.10 BMS Assembly

The three boards described previously are connected together as shown in [Figure 9](#).

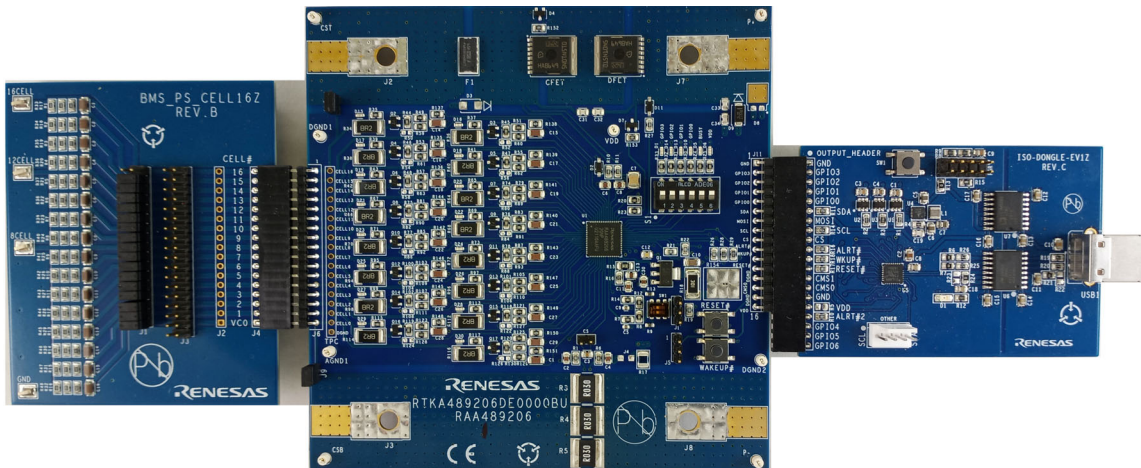

Figure 9. BMS Assembly

The resistor ladder and RAA489206 evaluation boards connectors line up Pin 1 to Pin 1 with a total of 17 pins. Pin 1 of both connectors is at the bottom of the mated pair shown in [Figure 9](#) and [Figure 10](#).

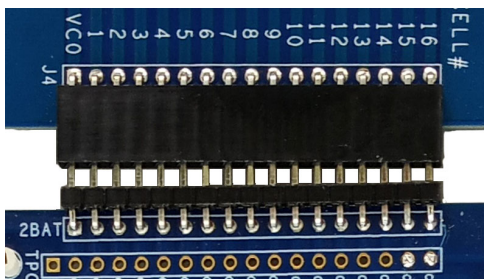

Figure 10. Cell Connection

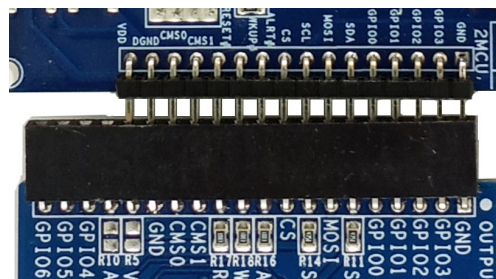

Figure 11. Dongle Connection

The dongle and RAA489206 evaluation board connectors line up Pin 1 to Pin 1, though the dongle has four extra pins. These extra pins are for use with other evaluation boards. Take note of the orientation of the two connectors in the assembly images ([Figure 9](#), [Figure 10](#), and [Figure 11](#)). When you have verified all of the connections, proceed to the next section.

1.11 High Current Loads

The evaluation board as configured in [Figure 9](#) is only capable of sourcing low load currents without inducing measurement errors. Jumper J9 connects the low-side current sense resistor to the bottom of the resistor ladder through the VC0 sense line. Jumper J10 connects the high-side load/charge path to the top of the resistor ladder through the VC16 sense line. This configuration routes load current through the voltage sense lines, which can induce offset errors in the cell measurements. A setup using a resistor ladder is not appropriate for charging tests.

For high currents a properly sized connection must be made between J3 and the negative terminal of the supply (or battery pack), then J9 should be removed. Another wire from J2 to the positive terminal of the supply is also necessary, then J10 should be removed. This separates the voltage sense lines from the load/charge current path to reduce errors to a minimum and is the recommended configuration for all applications.

2. RAA489206 GUI Start

Open the workbook to get started, there is no installation required. Macros are automatically disabled on some PCs; if the message **SECURITY WARNING Macros have been disabled** is visible beneath the menu bar, select **Enable Content**. This is shown in the [Figure 12](#).

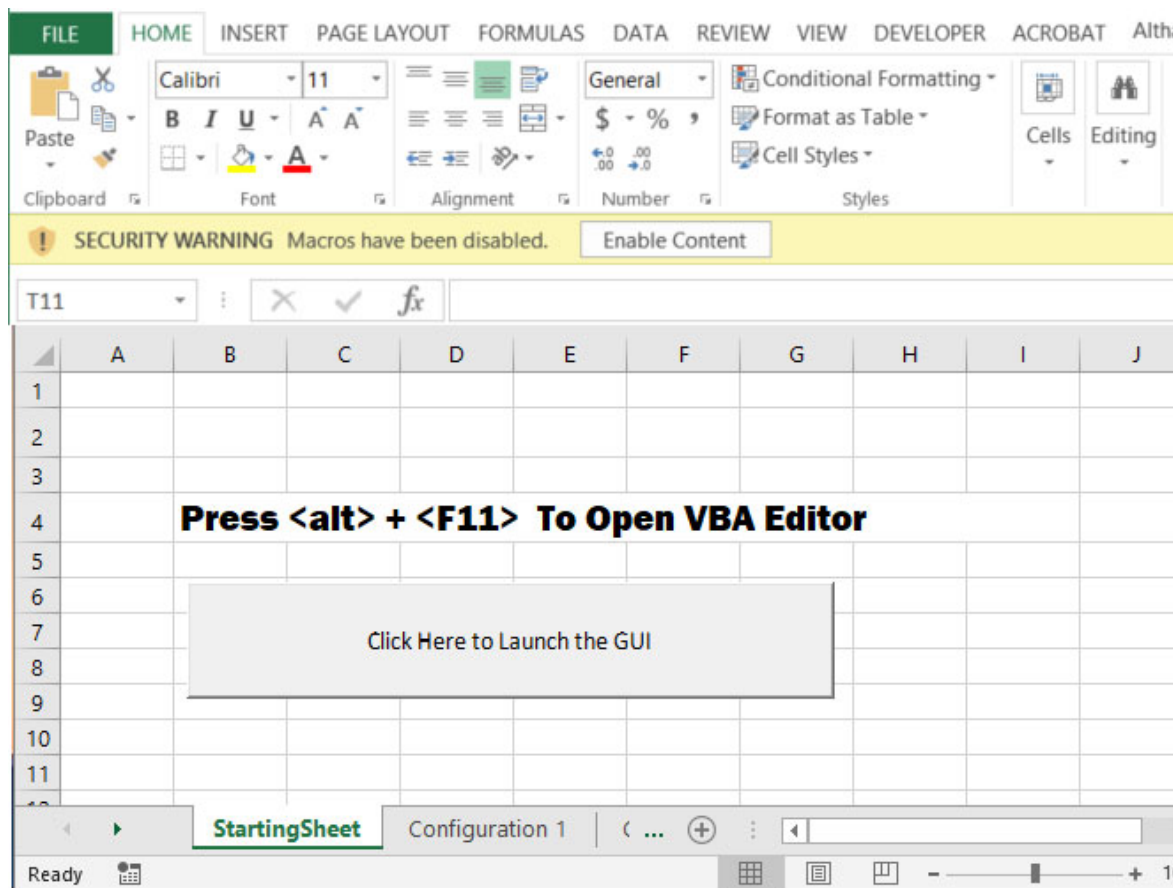

Figure 12. GUI Start

Press the **Launch** button to start the GUI. The first time the GUI is launched the Renesas Software License Agreement pop-up opens, select **I accept the agreement** and click **Continue** after reviewing it to start the GUI. The Renesas SLA opens each time the GUI is launched unless the spreadsheet is saved before closing.

When launching the GUI from the workbook, occasionally Excel stops responding and/or crashes. If this occurs, re-open the workbook and press **<Alt> + <F11>** to open the VBA editor. From here either press the green **play** button, outlined in red in [Figure 13](#), or press **<F5>** to launch the GUI.

Launching from the VBA editor can open the Demo GUI. Select the **Exit Demo** shown in Figure 14 button to close this and open the Evaluation GUI. The use of the Demo GUI is covered later in this document.

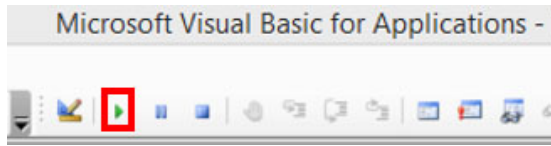

Figure 13. VBA Editor



Figure 14. Exit Demo

2.1 Power Supply

Enable the power supply connected to the resistor ladder board (or connect the battery pack). With VBAT set to 48V, the power supply should source ~32mA.

Typical power supplies only source current, this prevents demonstration of charging features using this type of supply. A battery pack or four-quadrant source/sink type of supply is required to demonstrate charging. Only a battery pack is suitable for cell balancing examples.

2.2 Connect

The GUI must detect the presence of both the evaluation board and dongle to operate, this is the **Connect** step. Insert the USB cable between the dongle and PC, then connect the dongle to the evaluation board. Press the green **Connect** button to start the detection process as shown in Figure 15.

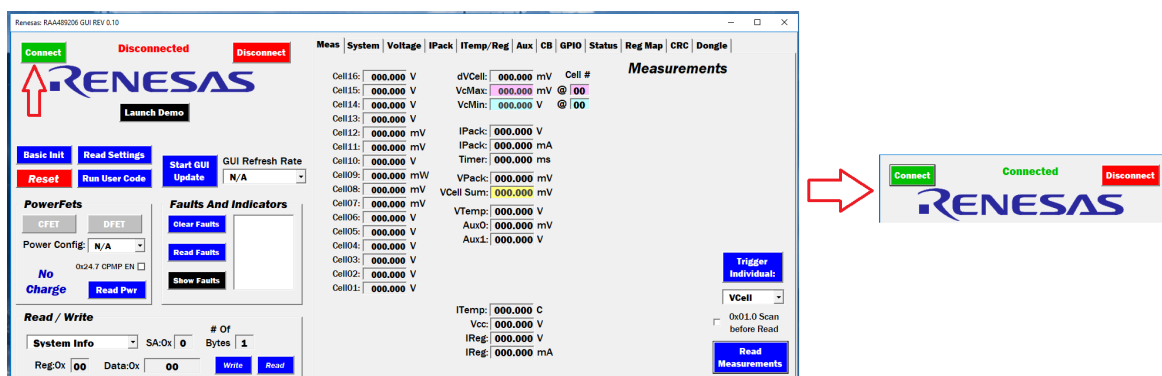

Figure 15. Connect

The device must be powered for this step to complete successfully. If the device is not powered up, an error message is displayed informing you that there was a communication error. When this error occurs you should either unplug then re-plug in the communications dongle, or press the reset button on the dongle (highlighted in Figure 16).

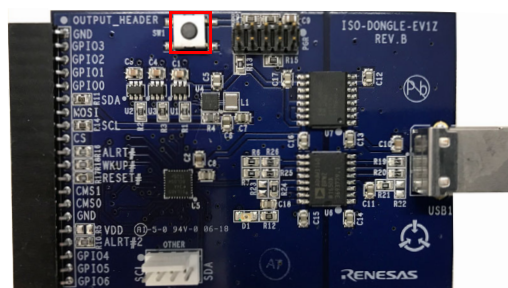

Figure 16. Reset Button

You must have read/write access permission for the USB port, this might require intervention by your IT resource(s) if Connect continuously fails.

2.3 Initialization

On startup, the GUI displays for the RAA489206 settings are empty. The RAA489206 has started up in its default configuration (see the RAA489206 datasheet). The displays must be synchronized with the RAA489206 by reading the present values from the device into the displays. After this, a basic initialization is also recommended.

2.3.1 Read Settings

Click on the **Read Settings** button on the left side of the GUI to sync the information displayed in the GUI to the settings in the RAA489206. This button operates in all but SHIP Mode.

2.3.2 Basic Init

Click on the **Basic Init** button on the left side of the GUI to set the RAA489206 into an operational mode chosen for evaluation purposes. This button automatically synchronizes displays to the settings in the RAA489206 after they are initialized. Basic Init operates regardless of mode as it begins with a hard RESET.

Following execution of Basic Init, the main display is shown in [Figure 17](#):

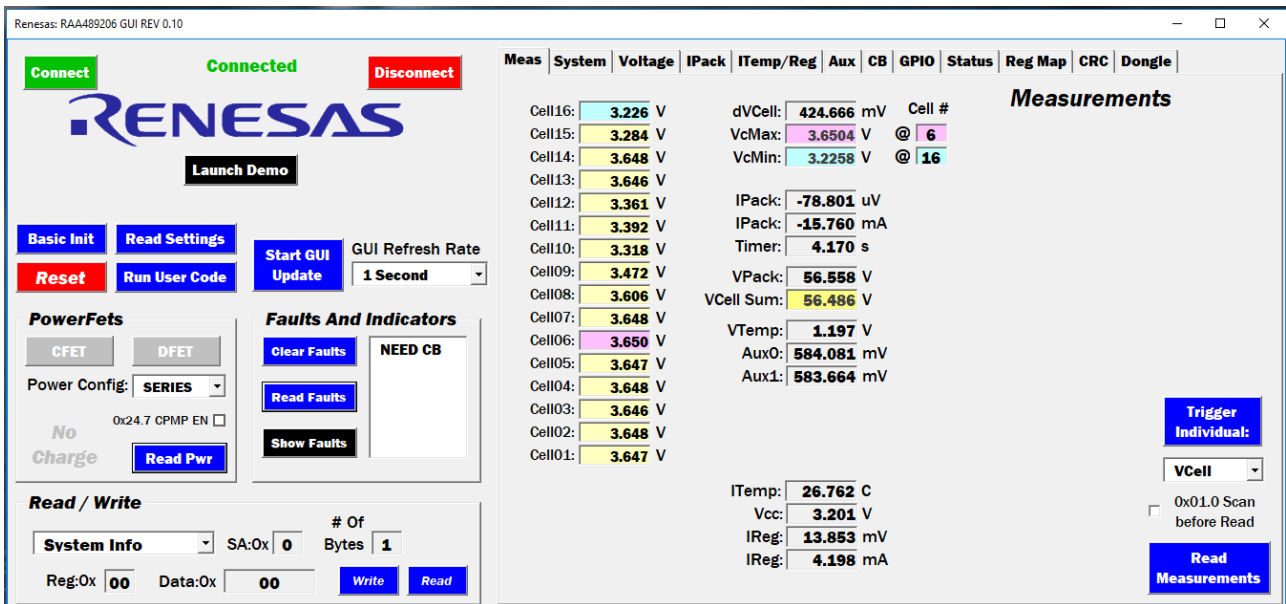

Figure 17. Main Display after Basic Init

Screen captures of Basic Init settings displayed in the tab panels can be found in [Appendix A](#).

3. SCAN Mode

For normal operation during charging or discharging of the Battery Pack, the RAA489206 should be in SCAN Mode. The system Mode is controlled by the Scan Operation register, shown in Table 1 and Table 2. The POR/RESET defaults are highlighted in yellow.

Table 1. 0x2E Scan Operation

Bits	D[7:6]	D[5:3]	D[2:0]
Bit Name	System Mode	Low Power Timer	Scan Delay
Default	00	01 1	011

The System Mode bits are used to manually put the RAA489206 into a specific mode.

Table 2. SM Mode

D[7:6]	SM Mode
00	IDLE mode
01	SCAN mode
10	LOW POWER mode
11	SHIP mode

A variety of important controls are changed from the default setting during Basic Init, some are set as shown in Figure 18. These settings can be found on the **System** tab. Review the datasheet descriptions for each of these registers to familiarize yourself with the control functions before proceeding.

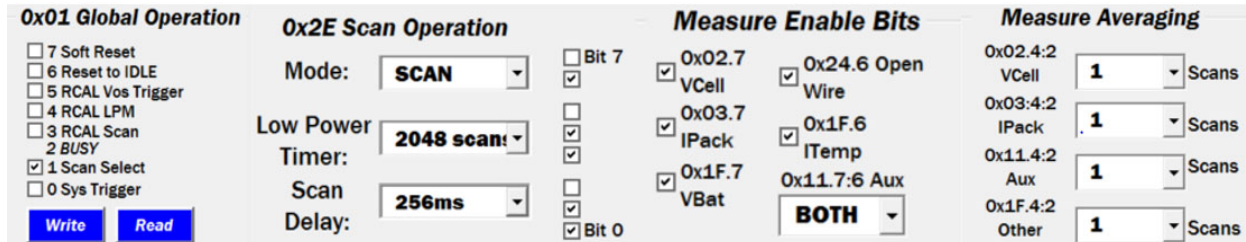

Figure 18. Basic Init

Bit 1 of the Global Operations register is set to 1 for Single Scan. With this setting, a System Trigger initiates a single measurement scan of all enabled measurements. If Bit 1 is set to 0 when a System Trigger is executed, the device runs Continuous Scans.

All of the Measure Enable Bits are set to enable measurement of all inputs during a system scan. The Measure Averaging setting for the measurements is set to 1.

The System Mode (Bits 7:6 of the Scan Operation register) are set to SCAN Mode. The Scan Delay bits are set to 256ms. Scan Delay only operates when running Continuous Scans.

The Low Power Timer sets the number of scans without a charge or discharge current detection required for the device to transition to low power mode.

3.1 Busy Bit

The RAA489206 has a read-only bit that indicates when the device is busy making measurements, Bit 2 of the Global Operations register. The bit is 1 when the device is busy measuring and 0 when idle. The bit value status is inverted and output on the $\overline{\text{ALRT}}$ pin if Mask Register 0x65 Bit 0 is set to 0 (done by Basic Init). $\overline{\text{ALRT}}$ is low when the device is busy and transitions high when measurements complete. This bit combined with $\overline{\text{ALRT}}$ is useful for applications and bench debug.

3.2 Single System Scans

Select the check box for Bit 0 of the Global Operations register, then click on the **Write** button (Figure 19) to trigger a single system scan while watching $\overline{\text{ALRT}}$ LED D5. With Bits 0 and 1 selected, we are writing 0x03 to this register.

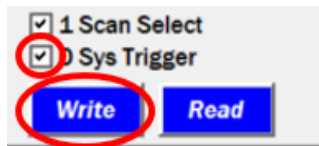

Figure 19. Single Scan



Figure 20. Read

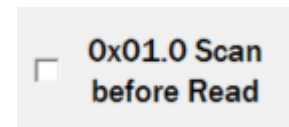

Figure 21. Scan

The LED should flash on for approximately 220ms given the Basic Init settings. The single system scan runs all tests on each trigger. Switch to the **Measurement** tab. Switching tabs automatically executes reads relevant to tab being switched to, so the measurements should automatically update on switching. Additionally, the **Read Measurements** button (Figure 20) can be clicked to confirm that the values were properly read by the GUI.

Check the **Scan before Read** box (Figure 21) then click the **Read Measurements** button. This triggers a system scan then displays the results of the measurements. As long as the device is in SCAN Mode and **Scan before Read** is checked, clicking the **Read Measurements** button operates in this manner. The **Scan before Read** box signals the GUI software to send a System Trigger and waits for the measurements to complete, then reads back the results. If the **Scan before Read** box is not checked, the button only executes a read.

3.2.1 Measure Enable Bits

As previously shown, the RAA489206 has several measure enable bits that allow you to control what is executed during a system scan. If the enable bits are set to 1, the related measurements are executed during a single system scan. Cell Voltage, IPack, Pack Voltage and Internal Temperature measurements along with Open-Wire detection can all be enabled or disabled. Additionally, there are four options for ETAUX: None, Only Aux0, Only Aux 1, or both. The **Basic Init** function enables all measurements and both thermistors.

If available, connect an oscilloscope probe to the $\overline{\text{ALRT}}$ pin and the ground to one of the DGND pins. Set up the scope to view a signal of 0V to 3.3V and a time span of 400ms to 500ms with a negative edge trigger. If a scope is not available, the $\overline{\text{ALRT}}$ LED is the indicator to be observed.

Note: The connection of the oscilloscope ground to the board ground can reset the RAA489206 if the board was floating relative to earth ground prior to this connection. If this happens, execute **Basic Init** to put the RAA489206 back to the required mode and settings. The dongle isolates the evaluation board ground from the PC ground. If the negative terminal of the power supply is not isolated from ground then the evaluation board is not either.

Check the **Scan before Read** box then click the **Read Measurement** button (Figure 17) to trigger a single system scan and display the results of the measurements. The scope capture should look similar to the image in Figure 22.

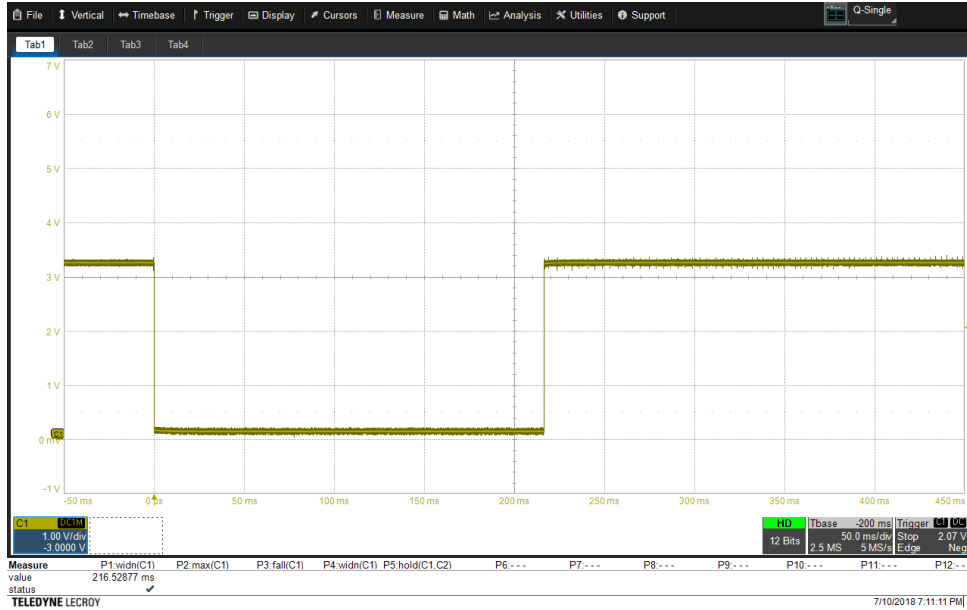

Figure 22. Oscilloscope Measurement Results

Experiment by disabling all but one Measurement Enable bit to see the busy times for each section.

Also, look at the effect on the measurement time of the averaging settings. The capture in Figure 22 was obtained with all measurements enabled and all averaging set to minimum.

3.3 Continuous System Scans

In the Global Operations register, clear all checked bits then click on the **Write** button to write 0x00. Select the **Read** button to read back and confirm the setting. The device is now set for continuous system scans, though we have not triggered it to start.

Before beginning continuous scans enable the power FETs. Though not required to perform continuous system scans, it is necessary to demonstrate the automatic FET response of various faults in the coming sections. To enable the power FETs, locate the **PowerFets** box on the left side of the GUI, check the **0x24.7 CPMP EN** box, which enables the charge pump. Click the **CFET** and **DFET** buttons; they should turn green. Click the **Read Pwr** button and confirm that the CPMP EN box is checked and the **CFET** and **DFET** buttons are green as seen in Figure 23

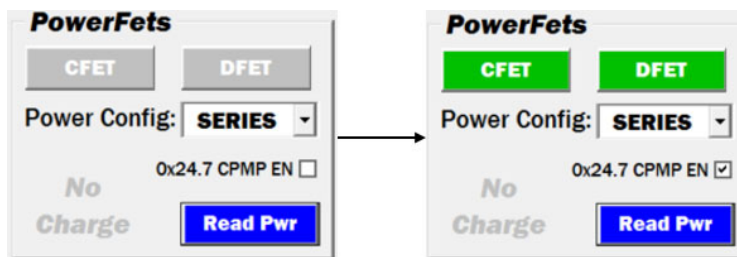

Figure 23. Power FETs

Next, check the **Status** tab to see that the status Bit 0x65.5 CP NRDY is now clear.

Select the check box for Bit 0 of the **Global Operations** register then click on the **Write** button below it to trigger a continuous system scan while watching **ALRT LED D5**. The LED is flashing because a continuous system scan is now running. With the settings given previously, the LED flashes about every 290ms, the first flash is ~220ms while most flashes are for ~35ms with the present settings. See 0x1B.5:4 Update Other and 0x03.6:6 OW Update sections in the datasheet as these affect the length of some subsequent scans. To stop the scan, clear all bits of

register 0x01 and set (check) Bit 0x01.1 Sys Select, then click on the **Write** button below it. Writing a value of 0x02 to register 0x01 stops the continuous scan.

Any changes to settings that are used as controls or thresholds during system scan (single or continuous) must be made when the system scan is STOPPED.

Experiment with the **Measure Averaging** settings on the **System** tab and note the change in the duration the busy bit sets the ALRT output low. Use an oscilloscope to measure the pulse width if one is available.

Be sure to stop the scan by setting Bit 0x01.1 Sys Select before making changes and restarting the scan.

Table 3. Scan Delay

Delay: D[2:0]			Delay (ms)
0	0	0	0
0	0	1	64
0	1	0	128
0	1	1	256
1	0	0	512
1	0	1	1024
1	1	0	2048
1	1	1	4096

The Scan Delay bits of the Scan Operation register control the delay time between finishing a System Scan measurement/test sequence in continuous scan mode and starting a new one. The various settings are shown in [Table 3](#). Experiment with the **SCAN DELAY** bit settings in the Scan Operation register and note the change in the delay between ALRT output low periods. Remember, the scan must be stopped to make changes to settings used during scan.

Stop the continuous system scan by setting Bit 0x01.1 Sys Select before proceeding to the next step.

3.4 Low Power Timer

The Low Power Timer bits select the number of consecutive System Scans with a current reading below the charge and discharge thresholds required before the RAA489206 transitions from SCAN Mode to LOW POWER Mode. [Table 4](#) shows the various Low Power Timer settings.

Table 4. Low Power Timer

Delay: D[5:3]			Number of Scans
0	0	0	OFF
0	0	1	512
0	1	0	1024
0	1	1	2048
1	0	0	4096
1	0	1	8192
1	1	0	16384
1	1	1	32768

In the **0x2E Scan Operation** area on the **System** tab, set the mode to SCAN, set the Low Power Timer to 512 scans, and the scan delay to 64ms. With these settings, each scan takes ~100ms. If the IPack voltage is between approximately $\pm 200\mu\text{V}$ for 512 consecutive scans, the device transitions from SCAN to LOW POWER Mode.

Execute a few single system scans, if the IPack voltage is not within the $\pm 200\mu\text{V}$ range and/or the indicator in the **PowerFets** block is not **No Charge** as seen in [Figure 24](#), then short out the IPack current sense resistor with a jumper across the 2-pin CS connector. This should only be done if no significant load is present. It might be necessary to set all S1 switches to OFF.

Set the Global Operations register to 0x01 to trigger a continuous system scan and watch the $\overline{\text{ALRT}}$ LED. After less than 60 seconds, the frequency of the LED flashing significantly decreases to ~2s as the device has transitioned from SCAN to LOW POWER Mode.

Click the **Read Page** button on the system tab and confirm the mode has switched to LOW PWR as shown in [Figure 25](#)

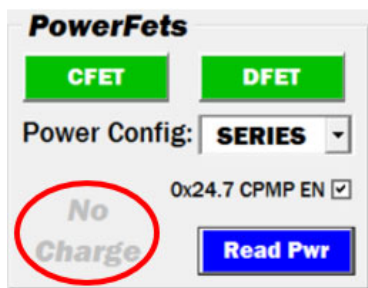

Figure 24. Power FETs

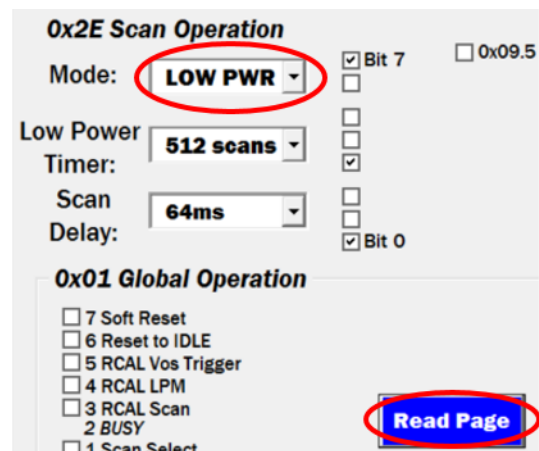

Figure 25. Scan Operation

4. IDLE Mode

IDLE Mode is the default mode following POR, RESET, or Reset-to-IDLE. An Important difference between IDLE and SCAN Modes is neither continuous nor single system scans can be executed in IDLE Mode. Current direction bits CHRG1 and DCHRG1 do not operate in IDLE Mode, current direction dependent faults set without regard to the current direction but the MCU is required to enable/disable CFET and DFET in IDLE Mode.

Put the RAA489206 in IDLE Mode. On the **Meas** tab with the **0x01.0 Scan before Read** box checked, click the read measurements button. Note the displays are not updated. Uncheck the **Scan before Read** box then use System Trigger Bit 0x01.0 to execute a system trigger followed by **Read Measurements**. Again the displays are not updated and the $\overline{\text{ALRT}}$ LED does not flash. Leave the **Scan before Read** box unchecked in IDLE Mode.

With the device in IDLE Mode, the individual trigger bits, as opposed to the System Trigger, must be used. The individual trigger bits operate in both SCAN and IDLE Modes.

4.1 VCell Trigger

On the **Meas** tab, select **VCell** from the drop-down menu and press the **Trigger Individual** button. This writes a 1 to VCell Operation Bit 0x02.0, which triggers a VCell measurement. The $\overline{\text{ALRT}}$ LED flashes during the measurement. Click **Read Measurements** and note that only the cell voltages, shown in [Figure 26](#), update. On the **System** tab, increase the Measurement Averaging count for VCell to 128. Trigger another VCell Measurement and note that the LED on time has increased, indicating a longer measurement period.

Cell16:	3.448	V
Cell15:	3.442	V
Cell14:	3.441	V
Cell13:	3.447	V
Cell12:	3.447	V
Cell11:	3.451	V
Cell10:	3.445	V
Cell09:	3.446	V
Cell08:	3.451	V
Cell07:	3.455	V
Cell06:	3.454	V
Cell05:	3.446	V
Cell04:	3.442	V
Cell03:	3.439	V
Cell02:	3.450	V
Cell01:	3.443	V

Figure 26. VCell Measure

4.1.1 Cell Select

Cell Select register settings (Figure 27) are found on the **System** tab of the GUI.

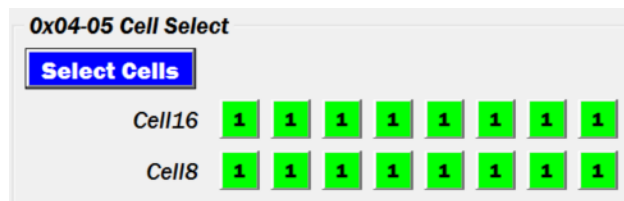

Figure 27. Cell Select

The Cell Select register sets which and how many cells the RAA489206 manages. If the box (and associated bit) corresponding to a particular cell is 0 and grayed out, that cell is not measured or compared to thresholds.

Clicking on any of the cell boxes toggles between a green box with a 1, and a gray box with a 0. Clicking **Select Cells** writes the displayed selections to registers 0x04 and 0x05. Cells represented by a green box are enabled while cells represented by a gray box are disabled. Toggle the boxes for Cells 8 and 9 to gray, then click the **Select Cells** button.

Trigger a cell voltage measurement. The $\overline{\text{ALRT}}$ LED flashes during the measurement. Click **Read Voltages** and note that all of the cell voltages update except Cells 8 and 9.

Enable Cells 8 and 9 before proceeding to the next section.

4.1.2 VCell Fault Detection

VCell Fault detection threshold register settings (Figure 28) are found on the Voltage tab of the GUI.

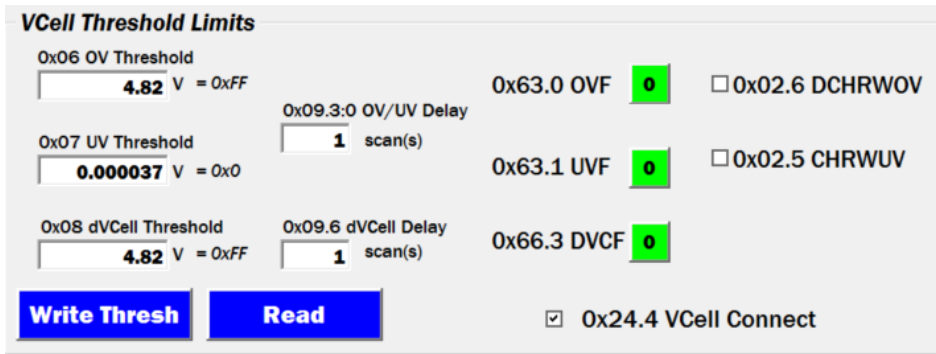

Figure 28. VCell Thresholds

During cell voltage measurement each enabled cell voltage is compared to both overvoltage (0x06) and undervoltage (0x07) threshold registers. The lowest cell voltage is subtracted from the highest cell voltage and this difference is compared to the VCell Delta Voltage (0x08) threshold. A threshold violation sets the fault bit associated with that threshold.

Enter a voltage in the box labeled 0x06 VCell OV that is less than at least one of the cell voltages, then click on **Write Thresh** and **Read** buttons. The GUI sets the threshold to the closest possible voltage setting without exceeding the entered value. Trigger a cell voltage measurement then **Read Measurements**. Notice the fault is indicated in both the **Faults and Indicators** box and on the VCell Portion of the Voltage tab as shown in Figure 29.

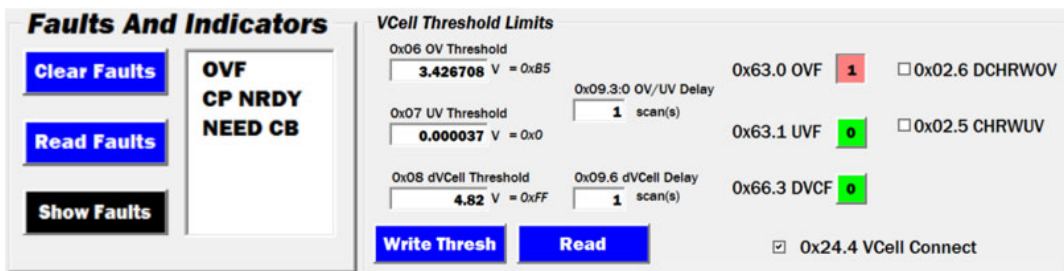

Figure 29. OV Fault

If in SCAN Mode the Power FETs have been disabled, but they remain on if in IDLE Mode or if no charge current is detected. Check the Pack+ voltage on the evaluation board with the multimeter to verify. Press the **Read Pwr** button in the **PowerFets** block.



Figure 30. FET Status (Disabled)

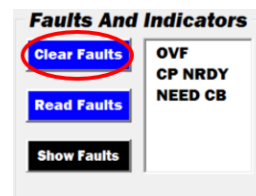

Figure 31. Faults and Status

Click on the **Clear Faults** then the **Read Faults** button and note the faults are now cleared. Whenever a **Clear Faults** is performed it should be followed by a **Read Faults** to verify the desired fault has been cleared. This is equivalent to writing a 1 to the VCell Operations register Bit 0x02.1, this bit is adjacent to the VCell Trigger bit.

Re-enable the Power FETs by clicking on the gray **CFET** and **DFET** buttons, they should turn green. Verify with the multimeter. Note the FETs are enabled while there is a cell overvoltage condition. The fault check is a digital

compare accomplished during the cell voltage measurement. Trigger another VCell measurement and verify the fault is detected and if the FETs have shut off.

Click on the **Clear Faults** button and note the faults are now cleared. Re-enable the Power FETs by clicking on the red **CFET** and **DFET** buttons, they should return to green. Set the VCell OV Threshold register to 4820mV. Trigger another VCell measurement and verify no fault is detected and the FETs stay on.

Experiment with threshold registers 0x07 UV Threshold and 0x08 Delta VCell Threshold using the previous sequence in both IDLE and SCAN Modes to verify the function of each. Similar to OV detection, a UV detection requires a discharge current detection to shut off the power FET(s).

Before proceeding to the next section, click on the **Clear Fault** button and re-enable the Power FETs by clicking on the red **CFET** and **DFET** buttons. Set the VCell OV, UV, and Delta V Threshold registers to default. Trigger another VCell measurement and verify no fault is detected and the FETs stay on.

4.2 IPack Trigger

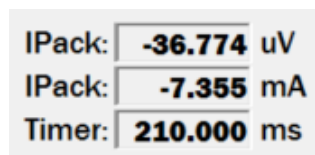

Figure 32. IPack Measure

Trigger a pack current measurement by selecting IPack from the drop-down menu on the **Meas** tab, then pressing **Trigger Individual**. The **ALRT** LED flashes during the measurement. Click **Read Measurements** and note only the IPack current measurements (Figure 32) update. Change the Measure Averaging for IPack on the **System** tab, trigger another measurement and note the LED on time has increased indicating a longer measurement period.

4.2.1 IPack Fault Detection

IPack Fault detection threshold register settings (Figure 33) are found on IPack tab of the GUI.

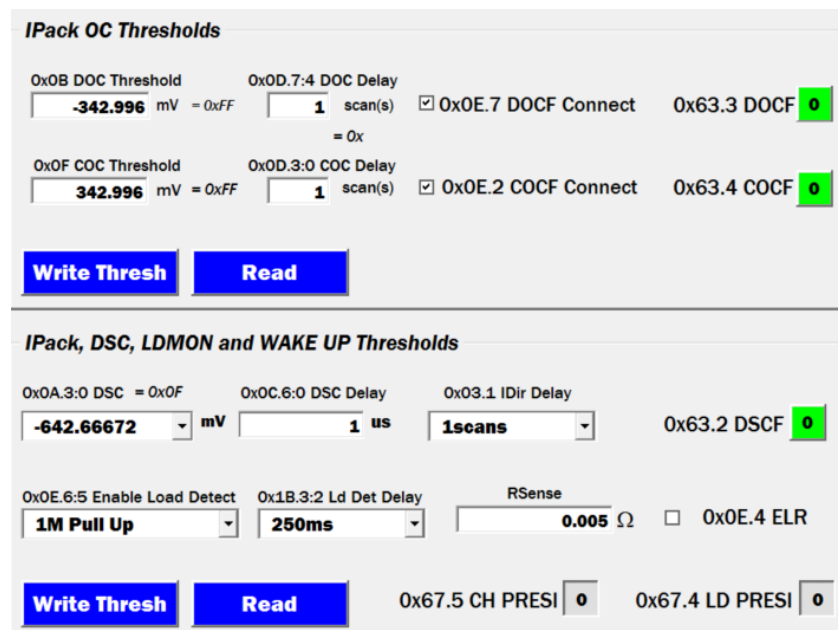

Figure 33. IPack Thresholds

If using a battery pack, most cells are capable of providing the necessary current for the following examples. When a power supply and resistor ladder are used instead of a battery pack, it is necessary to either apply a

voltage across the stock current-sense resistor to mimic an overcurrent condition or replace the current-sense resistors with a higher value component so the voltage threshold can be reached with a lower current.

Note: The **RSense** setting in the GUI must match the value of the current sense resistance on the evaluation board for the IPack current displayed on the **Meas** tab to be correct. Enter the new value in the box provided and hit the **Write Thresh** button to update. The default value of 0.005Ω matches the evaluation boards as shipped.

4.2.1.1 IPack Voltage Source

For setups using a power supply and resistor ladder, a second power supply connected across IPack can be used to trigger an overcurrent fault. A floating power supply, with the ground pin unconnected, is required for this function. Set the voltage to 0.0V, connect the positive terminal to J3 and the negative terminal to J8 to simulate a charge current.

4.2.1.2 COC Fault

Set the Charge Overcurrent Threshold register 0x0F to a voltage achievable with your setup while the IPack voltage is below this threshold. Trigger an IPack measurement then Read the results into the GUI display. No fault should be set. If the IPack voltage is >200μV and the device is in SCAN Mode, the CHRGI bit (0x67.6) should set indicating the device has detected a charge current. This can be monitored in the Power FETs Block as shown in [Figure 34](#). Step up the IPack current/voltage followed by a **Trigger** and **Read** until the threshold is violated and the COCF Fault bit (0x63.4) sets. The COCF indicator becomes red as seen in [Figure 35](#).



Figure 34. PowerFets Block

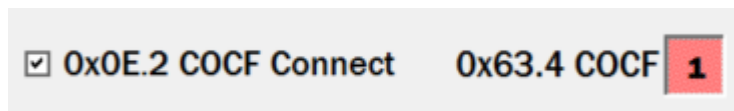

Figure 35. COCF

This fault is only detected during an IPack measurement, and when detected it shuts off the power FETs if the device is in SCAN Mode and Bit **0xE.2 COCF Connect** is set as in [Figure 35](#).

Execute Clear Fault and enable CFET and DFET using the methods previously described. Enter 5 in the two DOC and COC boxes ([Figure 36](#)) and then press Write Thresh to write the setting to their shared register (0x0D).

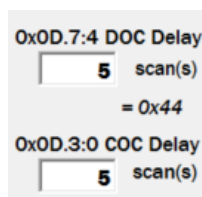

Figure 36. DOC and COC Delay

Put the device in SCAN Mode, trigger a continuous system scan then count the times the $\overline{\text{ALRT}}$ LED flashes. With this setting, five consecutive measurements above the threshold are required to trigger a fault, shut off the power FETs, and stop a system scan. These and the other fault counters only operate in continuous scan mode. In all other modes, only a single measurement above the threshold is required to trigger a fault. Automatic shut off of the power FETs only occurs in SCAN Mode as previously described.

Put the device in IDLE Mode, execute Clear Fault and enable CFET and DFET. Set the COC threshold register back to its maximum value.

Remove the charge current, or set the external IPack voltage source to 0.0V then disconnect it (setup dependent).

4.2.1.3 DOC Fault

Set register 0x0B Discharge Overcurrent threshold to a voltage achievable with your setup while the IPack voltage is below this threshold (less negative). Trigger an IPack measurement then Read the results into the GUI display. No fault should be set. If the IPack voltage is $< -200\mu\text{V}$ and the device is in SCAN Mode, the DCHRI bit (0x67.7) should set indicating the device has detected discharge current. This can be seen in the Power FETs block in Figure 37.



Figure 37. Power FETs Block

If your setup uses the IPack voltage source for charge/discharge current, connect the voltage source positive terminal to J8 and the negative terminal to J3. This is reversed from the COC arrangement.

Step up the magnitude of the IPack discharge current/voltage followed by a Trigger and Read until the threshold is violated and the DOCF Fault bit (0x63.3) sets as shown in Figure 38.

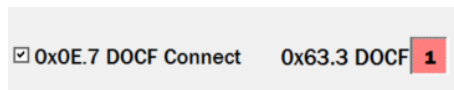

Figure 38. DOCF

Like COCF, this fault is only detected during an IPack measurement, and when detected in SCAN Mode it shuts off the power FETs given the DOCF Connect Bit 0x0E.7 is set.

Execute Clear Fault and enable CFET and DFET. If previously cleared, enter 5 in the two DOC and COC boxes (Figure 39) and write them to their shared register (0x0D).

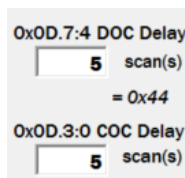

Figure 39. OC Delay

Put the device in SCAN Mode, trigger a continuous system scan then count the times the $\overline{\text{ALRT}}$ LED flashes. With this setting five consecutive measurements above the threshold are required to trigger a fault, shut off the power FETs and stop system scan. These and the other fault counters only operate in continuous scan mode. In all other modes, only a single measurement beyond the threshold is required to trigger a fault. Automatic shut off of the power FETs only occurs in SCAN Mode as previously described.

Put the device in IDLE Mode, execute Clear Fault and enable CFET and DFET. Set the DOC threshold register back to its maximum negative value.

Remove the discharge current, or set the external IPack voltage source to 0.0V then disconnect it (setup dependent).

4.3 VREG Trigger

Select the **Meas** tab. Select VReg from the drop-down list then press the **Trigger Individual** button to trigger a regulator voltage measurement. Click **Read Measurements** and note that only the VCC and IREG voltage displays update (Figure 40). Because these voltages are very stable relative to the LSB size, multiple trigger/read cycles can be necessary to see a change in the display.

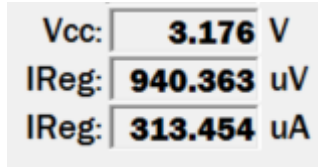

Figure 40. Reg Measure

The IReg Sense R resistor value is set in the ITemp/Reg tab and is used to calculate the IReg current value displayed on the **Meas** tab. This resistor is 3.3Ω on stock RevC EVKITs. Check R15 on the evaluation board to be certain, it is nearest to the lower right corner of the RAA489206.

4.3.1 VCC Min Threshold

The VCC Minimum Threshold register on the ITemp/Reg tab sets the minimum VCC/VDD operating voltage. If VCC drops below this threshold, the fault Bit 0x63.7 VCCF sets (viewable on the **Status** tab).

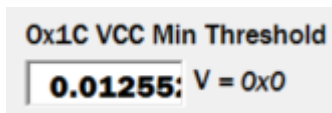

Figure 41. VCC Min

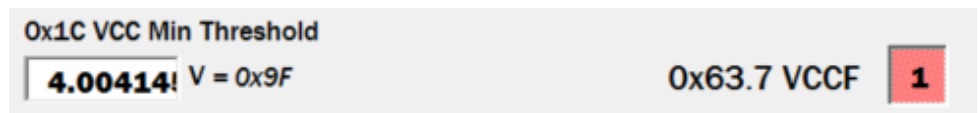

Figure 42. VCC Min and VCCF

Set the 0x1C VCC Min Threshold to a value greater than the last reading for VCC as shown in Figure 40 and Figure 41. Trigger a VReg measurement using the VReg Trigger then read the voltages and status bits. The VCCF bit should set as seen in Figure 42.

Note: After the voltage is measured it is compared to the VCC Min Threshold and the VCCF bit sets, CFET and DFET are turned off. If this occurs during a continuous system scan in SCAN Mode then scan is stopped.

Set the 0x1C VCC Min Threshold to its minimum, execute Clear Fault and enable CFET and DFET.

4.3.2 IReg OC1 Threshold

The Regulator Overcurrent 1 threshold register on the ITemp/Reg tab sets the maximum regulator current threshold when the device is in either SCAN or IDLE Mode. The threshold setting is compared to the voltage across the IREG sense resistor R15. If the current through the sense resistor causes the voltage to violate this threshold, fault Bit 0x67.2 IREG1 sets.

Set the 0x1D IRegOC1 Threshold (Figure 43) to a value less than the last reading for IREG (as shown in Figure 40 on the previous page). On the **Meas** tab, select VReg from the drop-down list and then press Trigger Individual to trigger a VReg measurement. Press **Read Measurements** to read back the result.



Figure 43. IRegOC1 Threshold



Figure 44. IREG1F

After the voltage is measured, it is compared to the VReg Min Threshold and the IREG1 fault bit sets (Figure 44), CFET and DFET are turned off. If this occurs during a continuous system scan in SCAN Mode, the scans also stop.

Setting LED switches S1 to ON and setting the GPIO pins low (see Figure 84) increases the regulator current. Set the 0x1D IRegOC1 Threshold to its maximum, execute Clear Fault and enable CFET and DFET.

4.3.3 IReg OC2 Threshold

The Regulator Overcurrent 2 threshold register on the ITemp/Reg tab (Figure 45) sets the maximum regulator current threshold when the device is in LOW POWER Mode. The threshold setting is compared to the voltage across the IReg sense resistor. If the current through the sense resistor causes the voltage to violate this threshold, fault Bit 0x67.1 IReg2 sets.



Figure 45. IReg OC2

Set the 0x1E IRegOC2 Threshold to a value less than the last reading for IReg as previously shown. Trigger a VReg measurement using the VReg Trigger then read the voltages and status bits. Because this threshold is only active in LOW POWER Mode and the device is in IDLE Mode, the voltage updates but no fault is detected. At this point make sure the measured voltage is greater than the set threshold voltage.

Put the device in LOW POWER Mode by selecting **LOW PWR** from the Mode drop-down menu on the **System** tab and watch the $\overline{\text{ALRT}}$ LED. Press the **Read Faults** button on the first flash. If the threshold is violated, the IREG2 bit sets as shown in Figure 46 within ~256ms.

Note: Bit 0x65.5 CP NRDY also sets. This occurs if the charge pump was enabled prior to the transition to LOW POWER Mode and was not triggered by the IREG2 fault.

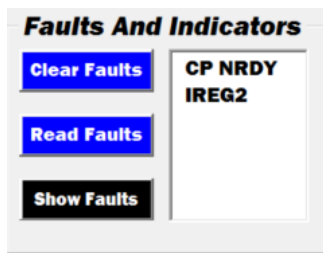

Figure 46. IREG2 Fault

Put the device in **IDLE Mode** by selecting **IDLE** from the Mode drop-down menu on the **System** tab then press Read Page on the system tab to confirm the mode was switched successfully. The Bit 0x65.5 CP NRDY clears automatically, CFET and DFET turn back on but IREG2 remains set.

Set the 0x1E IREGOC2 Threshold to its maximum and execute Clear Faults.

4.4 VBAT/ITEMP Triggers

On the **Meas** tab select **VBat** from the drop-down list to trigger an individual measurement. Click **Read Measurements** and note that only the VPack display updates. On the **System** tab increase the Measure Averaging Value for **Other**. Perform another individual VBat measurement and note the increase in the amount of time the $\overline{\text{ALRT}}$ LED is on. On the **Meas** tab select **ITemp** from the drop-down list and then press the **Trigger Individual** button. Perform a read measurement and note that only the ITemp value updates.

4.4.1 VBAT1 OV Threshold

The Vbat1 Overvoltage Threshold register sets the maximum voltage for the VBAT1 pin voltage, exceeding this voltage during charging in SCAN Mode sets the Bit 0x65.7 VBOVF and shuts off the power FETs.

Trigger an Individual VBat measurement and read back the results.

On the **Voltage** tab, in the VPack Threshold Limits section shown in Figure 47, set register 0x20 BAT1 OV to a voltage less than the measured result.

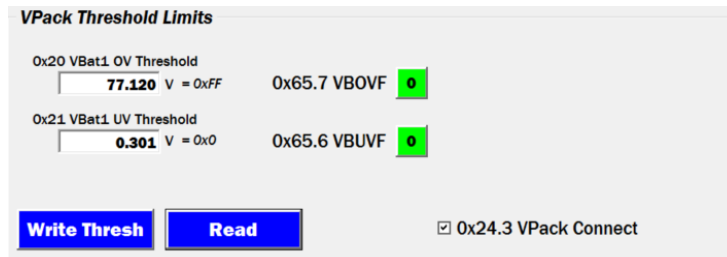

Figure 47. VBat1 OV

Trigger another VBAT voltage measurement and read back the results, VBOVF is now set as seen in Figure 48.

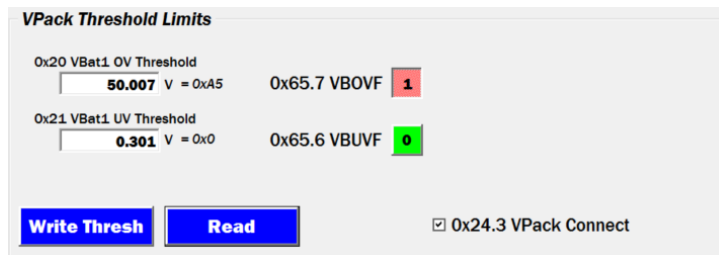

Figure 48. VBOVF

If the device is charging (CHRG1 is set), CFET and DFET shuts off. If running in continuous scan, the scan stops. If discharging or neither, the FETs stay on. Verify this by experiment.

Set the 0x20 OVBAT1 to its maximum, execute Clear Fault, enable CFET and DFET and put the device back into IDLE Mode.

4.4.2 VBAT1 UV Threshold

The Vbat1 Undervoltage Threshold register sets the minimum voltage for the VBAT1 pin voltage, dropping below this voltage during discharge in SCAN Mode sets the Bit 0x65.6 VBUVF and shuts off the power FETs.

On the **Meas** tab, select **VBat** from the drop-down list and then press **Trigger Individual**. Read Measurements and notice the VPack result updates.

On the **Voltage** tab, adjust the value of **0x21 VBat1 UV Threshold** to a voltage greater than the measured result. Then press **Write Thresh** to write the setting to the device, followed by a **Read** to confirm the setting was set properly.

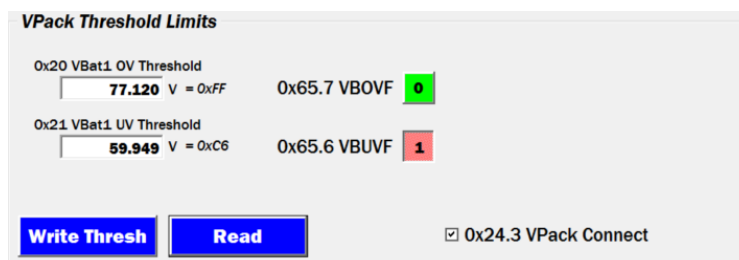

Figure 49. VBUVF

Trigger another VBAT voltage measurement and read back the results, VBUVF is now set as shown in [Figure 49](#). All Fault and status bits are also viewable on the Status tab.

If the device is discharging (DCHRG1 is set), CFET and DFET shut off. If running in continuous scan, the scan stops. If charging or neither, the FETs stay on. Verify this by experiment.

Set the 0x21 UVBAT1 to its minimum, execute Clear Fault, enable CFET and DFET and put the device back into IDLE Mode.

4.4.3 Internal Temperature

The RAA489206 has an internal temperature sensor with two programmable over-temperature thresholds, a warning and a fault. The trigger for internal temperature sensor measurement and the result display was covered previously. The thresholds are on the **ITemp/Reg** tab shown in [Figure 50](#).

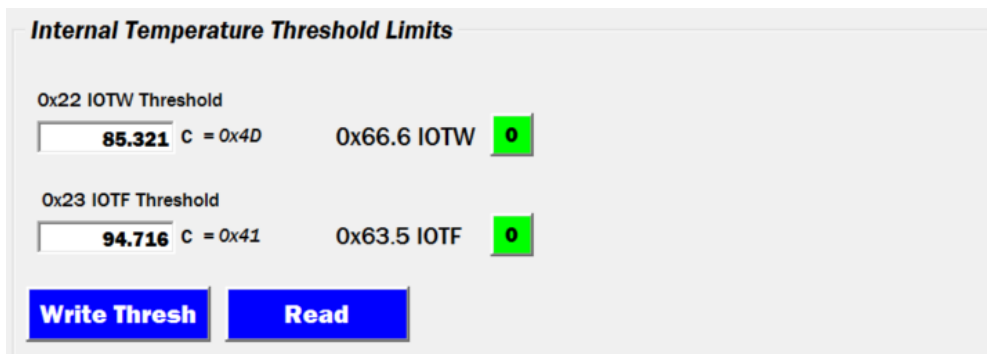

Figure 50. IOTW and IOTF

4.4.3.1 IOTW Threshold

On the **Meas** tab, select **ITemp** from the drop-down menu then press **Trigger Individual**. Select Read Measurements and note the ITemp value. On the **ITemp/Reg** tab set **0x22 IOTW Threshold** to about 10 degrees less than the previously returned ITemp value. Perform Write Thresh followed by a Read to confirm the setting.

Trigger another internal temperature measurement, then Read Measurements and note the IOTW bit is set as seen in [Figure 51](#).

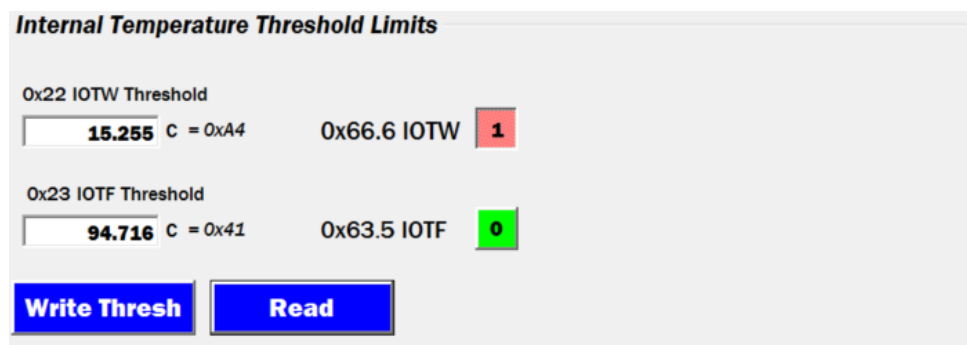

Figure 51. IOTW

This is intended as a warning bit, it does not shut off the power FETs or stop continuous system scans.

4.4.3.2 IOTF Threshold

On the **ITemp/Reg** tab, set **0x23 IOTF Threshold** to about 5° less than the ITemp display value then perform a **Write Thresh** followed by a **Read** to set and confirm the threshold.

Trigger another internal temperature measurement, then Read Voltages and note the IOTF bit is set as seen in [Figure 52](#).

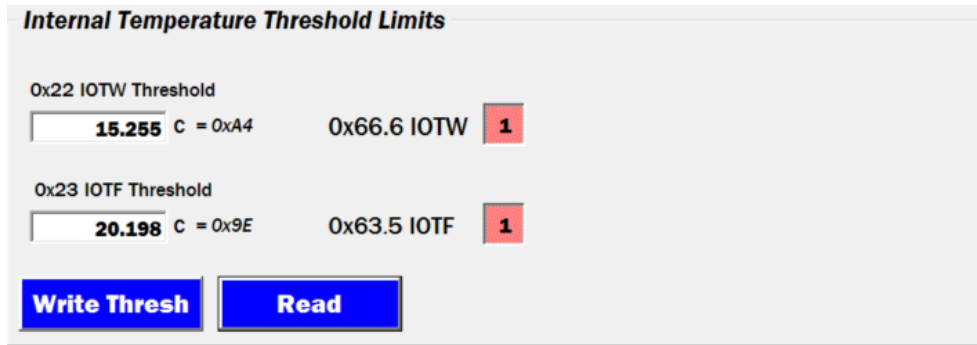

Figure 52. IOTF

This is the internal temperature fault bit, if set it shuts off the power FETs and stops continuous system scans. Verify these fault bits are also set on the **Status** tab.

Set register 0x22 IOTW Threshold to about 85° and register 0x23 IOTF Threshold to about 95°. Trigger another internal temperature measurement, then Read Voltages and note the IOTW and IOTF bits remain set. While the IOTF bit is set the power FETs cannot be turned on and scan does not start. Use the Clear Fault function, then trigger another measurement. Both IOTW and IOTF are now clear and the FETs can be turned on, if the FETs are off turn them back on to verify.

4.5 COMM Timeout

The VBAT Control register includes a communications timeout bit at 0x1F.1. On the System tab in the top Right corner check **0x1F.1 Comm TO Enable** to enable the RAA489206 to react to an unexpected loss of communications with the MCU. This check box is highlighted in [Figure 53](#).

Put the device in **IDLE Mode** by selecting **IDLE** from the drop-down **Mode** menu on the **System** tab as shown in [Figure 54](#).

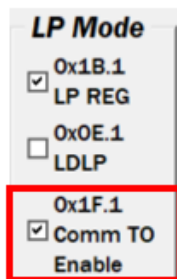

Figure 53. Comm TO

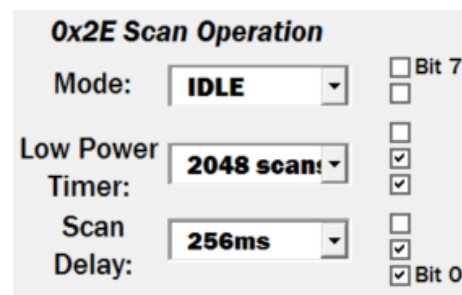

Figure 54. IDLE Mode

After approximately 4s without communications the device transitions from IDLE to LOW POWER Mode. After this happens, the ALRT LED flashes approximately every 2s. Verify the Mode change by reading register 0x2E.

Put the device in IDLE Mode by selecting it from the drop-down menu, then uncheck the **Comm TO Enable** box to disable the Timeout function.

5. LOW POWER Mode

Put the device in LOW POWER Mode by selecting **LOW PWR** from the Mode drop-down menu on the **System** tab as shown in [Figure 55](#).

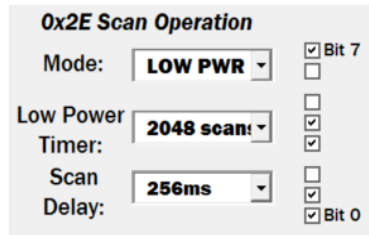

Figure 55. LP Mode

As stated previously, while in this mode the $\overline{\text{ALRT}}$ LED flashes every ~2s while the RAA489206 powers up necessary circuitry to make measurements, then powers down again.

Click on the Read Voltages button a few times and note the results. Measurement results are not stored in the data registers in LOW POWER Mode, but they are compared to Fault thresholds (see datasheet). On exit from LP Mode the last results obtained are stored in the data registers if transitioning to SCAN or IDLE.

5.1 Strong/Weak Regulator

On the **System** tab, confirm that **0x1B.1 LP REG** is checked as shown in [Figure 56](#). The bit should already be set as part of the Basic Init operation. Connect a voltmeter to either of the RAA489206 power pins, VDD or VCC. The voltage reads ~3.3V throughout the ~2s measurement cycle.

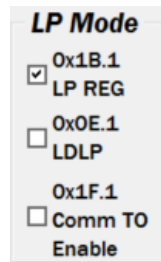

Figure 56. LP Reg

Now uncheck 0x1B.1 to and monitor the voltage with an oscilloscope. The voltage reads ~3.3V during the short measurement period, then drops to ~2.3V during the idle time between measurements.

The Strong regulator operates at ~3.3V with the external transistor in the feedback loop.

The Weak regulator operates at ~2.3V and it excludes the external transistor. The Weak regulator is only intended to drive the RAA489206 with enough voltage/current to maintain the register settings and communications. The Weak regulator is not able to drive external circuitry.

6. SHIP Mode

Put the device in SHIP Mode by selecting **SHIP** from the Mode drop-down menu on the System tab as shown in Figure 57.

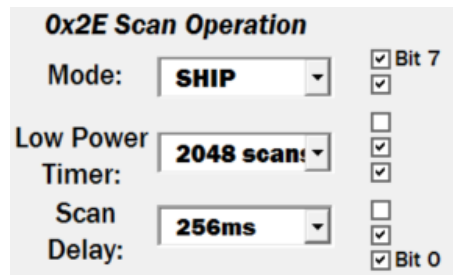

Figure 57. SHIP Mode

Click on the **Read Voltages** button and note the results. While in SHIP Mode the IC does nothing but wait for a WAKEUP or a RESET assertion or a change mode command. All reads or writes that do not access the Scan Operation register return a NACK. The GUI interprets this as junk data when updating the display.

6.1 Strong/Weak Regulator

Put the device in **IDLE Mode** by selecting **IDLE** from the Mode drop-down menu on the **System** tab as shown in Figure 57. Confirm the box **0x1B.1 LP REG** is checked. Connect a voltmeter to either of the RAA489206 power pins, VDD or VCC, to monitor the supply voltage. Set all LED switches to OFF to remove this component of the supply current.

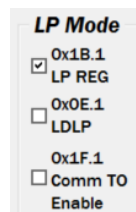

Figure 58. LP Reg

Put the device in SHIP Mode by selecting **SHIP** from the Mode drop-down menu. The supply voltage reads ~3.3V because the strong regulator remains on in **SHIP Mode** if the **LP REG** Bit 0x1B.1 is set to 1.

Note the supply current. Disconnect the dongle from the evaluation board, do not execute any GUI functions with the dongle disconnected. Note the supply current again. Reconnect the dongle. This example demonstrates the dongle draws current from the RAA489206 evaluation board, which is not part of the normal evaluation board current.

Put the device in **IDLE Mode** by setting Scan Operation Bits 0x2E.7:6 to 00 on the **System** tab. Uncheck the **0x1B.1 LP REG** box on the **System** tab.

Put the device in SHIP Mode by selecting from the Mode drop-down menu. The supply voltage reads ~2.4V because the weak regulator is on in SHIP Mode if the **LOW PWR REG SEL** Bit 0x1B.1 is set to 0.

Note the supply current. Disconnect the dongle from the evaluation board, do not execute any GUI functions with the dongle disconnected. Note the supply current again. Reconnect the dongle.

6.2 Wakeup

Continuing from the previous section, the RAA489206 should be in SHIP Mode with the weak regulator active. Press the **Read Page** button on the **System** tab to read the settings, including the Scan Operation Register.

Press the **WAKEUP#** button (NOT RESET#) on the evaluation board and then perform another **Read Page** on the system tab. Note the mode has returned to IDLE as seen in [Figure 59](#).

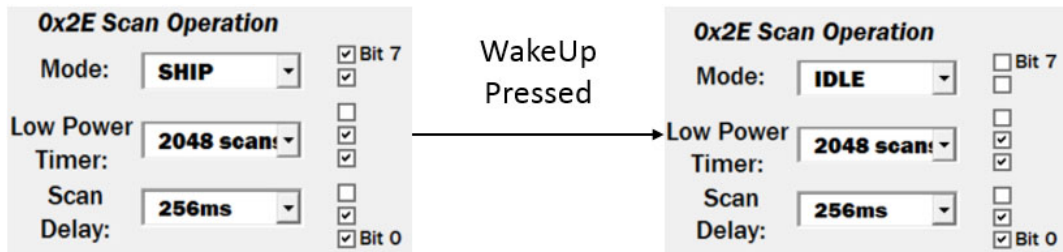

Figure 59. Wake Up

7. Demonstration GUI

Built into the full Evaluation GUI, there is also a demonstration GUI designed to highlight some of the key features and behaviors of the RAA489206.

7.1 Launching the Demo GUI

To launch the demo GUI, first press the green **Connect** button. If the device is not connected, the demo GUI does not launch and you are prompted with an error message. After connecting, press the **Launch Demo** button to bring up the demo GUI. This sequence is highlighted in [Figure 60](#).

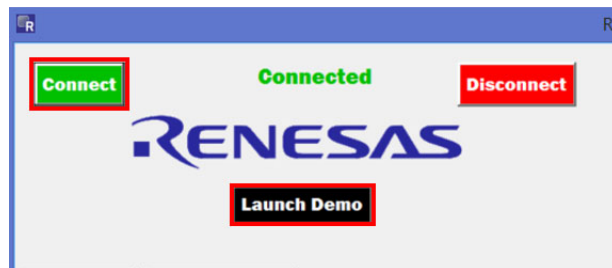

Figure 60. Connect

7.2 Initializing the Demo GUI

After launching the demo GUI, press the **Demo Init** button on the left side of the GUI as highlighted in [Figure 61](#). This configures the RAA489206 with settings appropriate for demonstration, and reads these settings into the GUI.

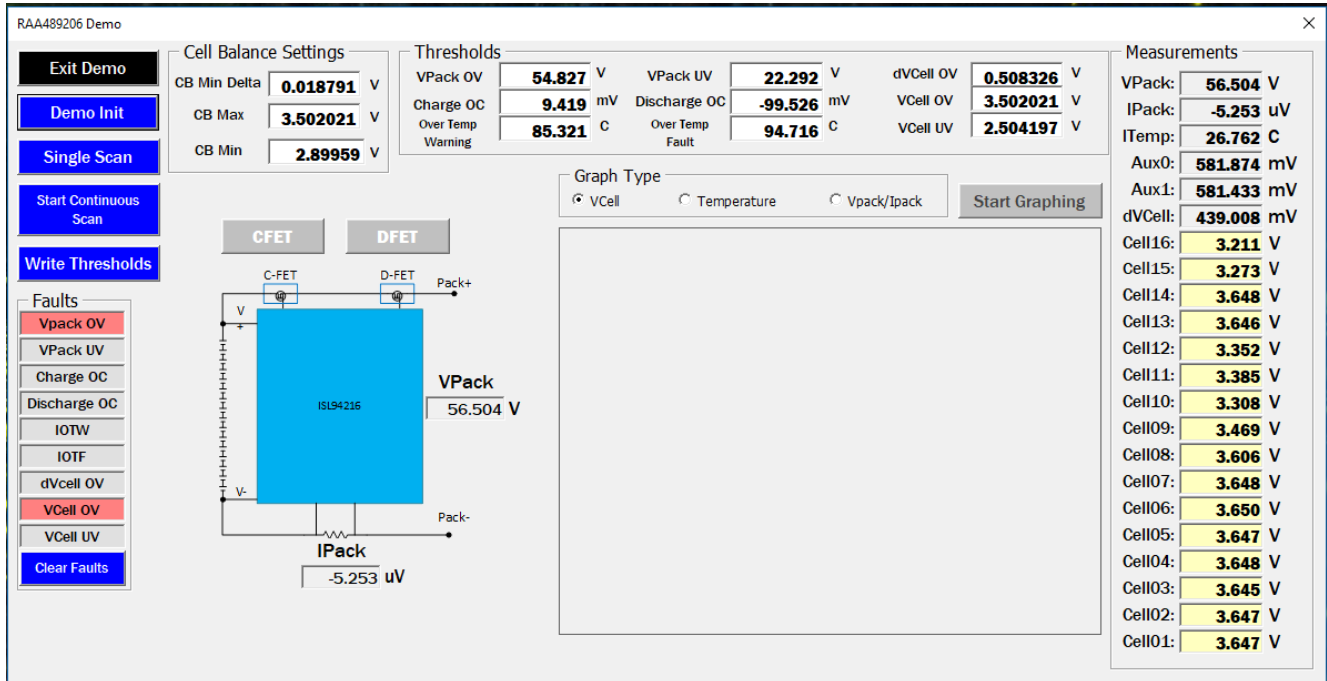

Figure 61. Demo GUI

7.3 Demo Single Scan

The **Single Scan** button, highlighted in [Figure 62](#), performs a single system scan and reads back all relevant information into the demo GUI. This includes not only the measurements, but the faults/status bits, thresholds, and any other information displayed in the demo GUI.

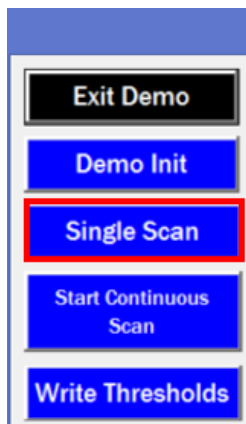

Figure 62. Single Scan

7.4 Demo Continuous Scan

The demo GUI also offers the ability to start and monitor a continuous scan in the RAA489206. To do this, press the **Start Continuous Scan** button, shown in [Figure 63](#).

When the continuous scan has begun, the GUI updates approximately every two seconds with information from the previous scan. To prevent the system trigger bit from getting stuck, the Single Scan function is disabled while

a continuous scan is running. To stop the continuous scan, press the **Stop Continuous Scan** button shown in Figure 64.

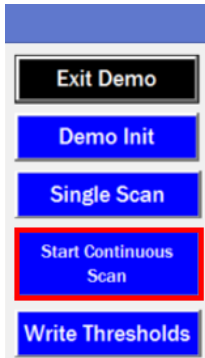

Figure 63. Start Continuous Scan

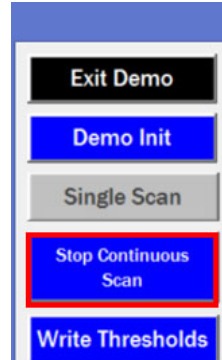

Figure 64. Stop Continuous Scan

7.5 Demo Graphing

The demonstration GUI enables graphing of measurements of interest versus time.

Note: The graphing function generates an image in the directory in which the workbook is stored to work properly.

To use the graphing function a continuous scan must be in progress, otherwise the **Start Graphing** button is grayed out and locked as seen in Figure 65.



Figure 65. Graph Type

The Graph displays information based on which option is selected in the **Graph Type** section. The VCell option displays the voltage of each cell, the temperature option shows both internal and auxiliary temperatures, and the VPack/IPack option shows the VPack and IPack values. When graphing has started you can freely switch between the three Graph Types without erasing the data for any of them. An example of a VCell graph is shown in Figure 66.

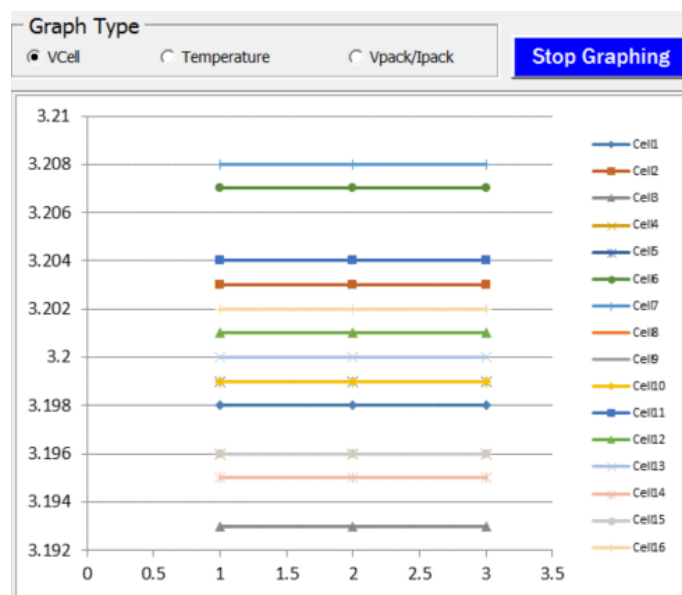

Figure 66. VCell Graph

If you wish to look more closely at the data that is used to make the graphs, it can be seen on the **Graph Sheet** tab (Figure 67) of the GUI workbook. This data gets erased every time **Start Graphing** is pressed.

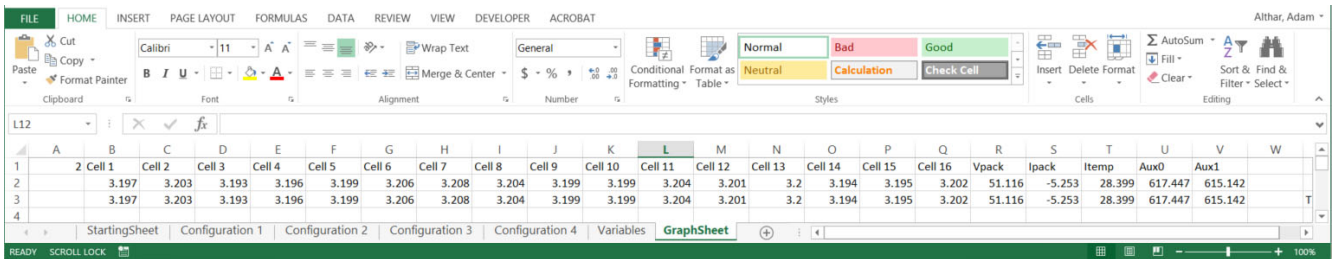

Figure 67. Graph Sheet

7.6 Demo Threshold Modification

Demo Init sets some of the key thresholds in the RAA489206 to values more useful than that of the default values, but these values might need to be modified further. To modify any of the available settings, simply change the value in the boxes highlighted in Figure 68, then press the **Write Thresholds** button. A single scan can be used to confirm the settings were written correctly.

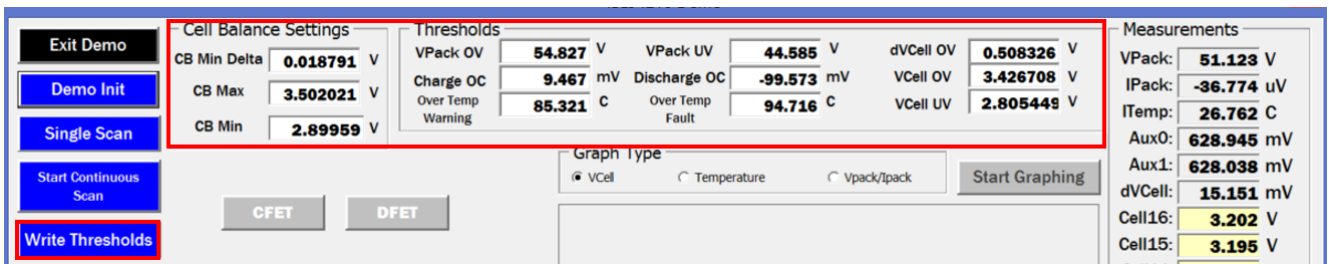

Figure 68. Demo Thresholds

7.7 Demo Fault Indicators/Clearing

The bottom left side of the screen provides fault indicators. If any of the faults listed are detected during a system scan, the corresponding fault box turns red. This can be seen in Figure 69 for VCell OV. Pressing **clear faults** writes these bits to 0. However, keep in mind some faults cannot be written low while the fault condition persists.

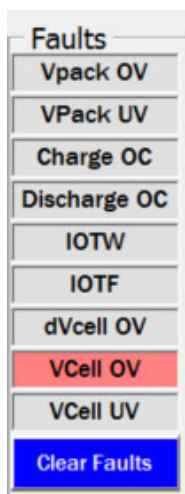

Figure 69. Demo Faults

7.8 Exiting the Demo GUI

To return to the evaluation GUI from the demonstration GUI simply press the **Exit Demo** button in the top left corner of the display. This button is highlighted in [Figure 70](#).

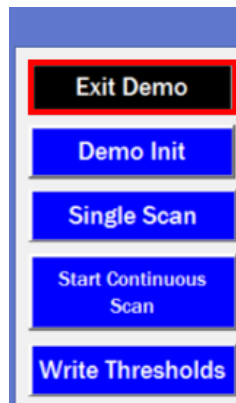
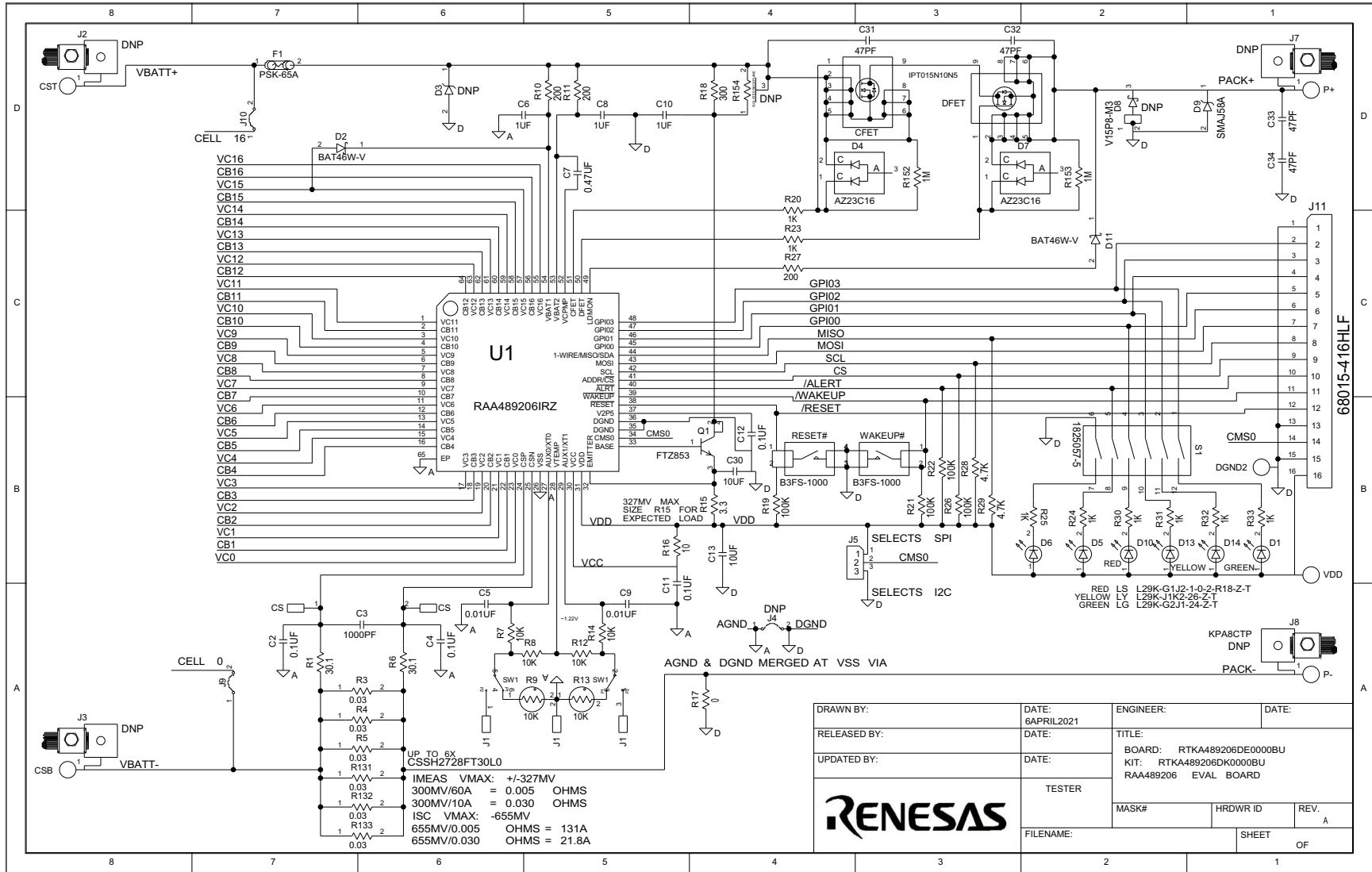

Figure 70. Exit Demo

8. Board Design

8.1 Schematic Drawings



DRAWN BY:	DATE: 6APRIL2021	ENGINEER:	DATE:
RELEASED BY:	DATE:	TITLE:	
UPDATED BY:	DATE:	BOARD: RTKA489206DE0000BU	
		KIT: RTKA489206DK0000BU	
		RAA489206 EVAL BOARD	
	TESTER	MASK#	HRDWR ID
			REV. A
FILENAME:		SHEET	OF

Figure 71. Eval Board Schematic Sheet 1

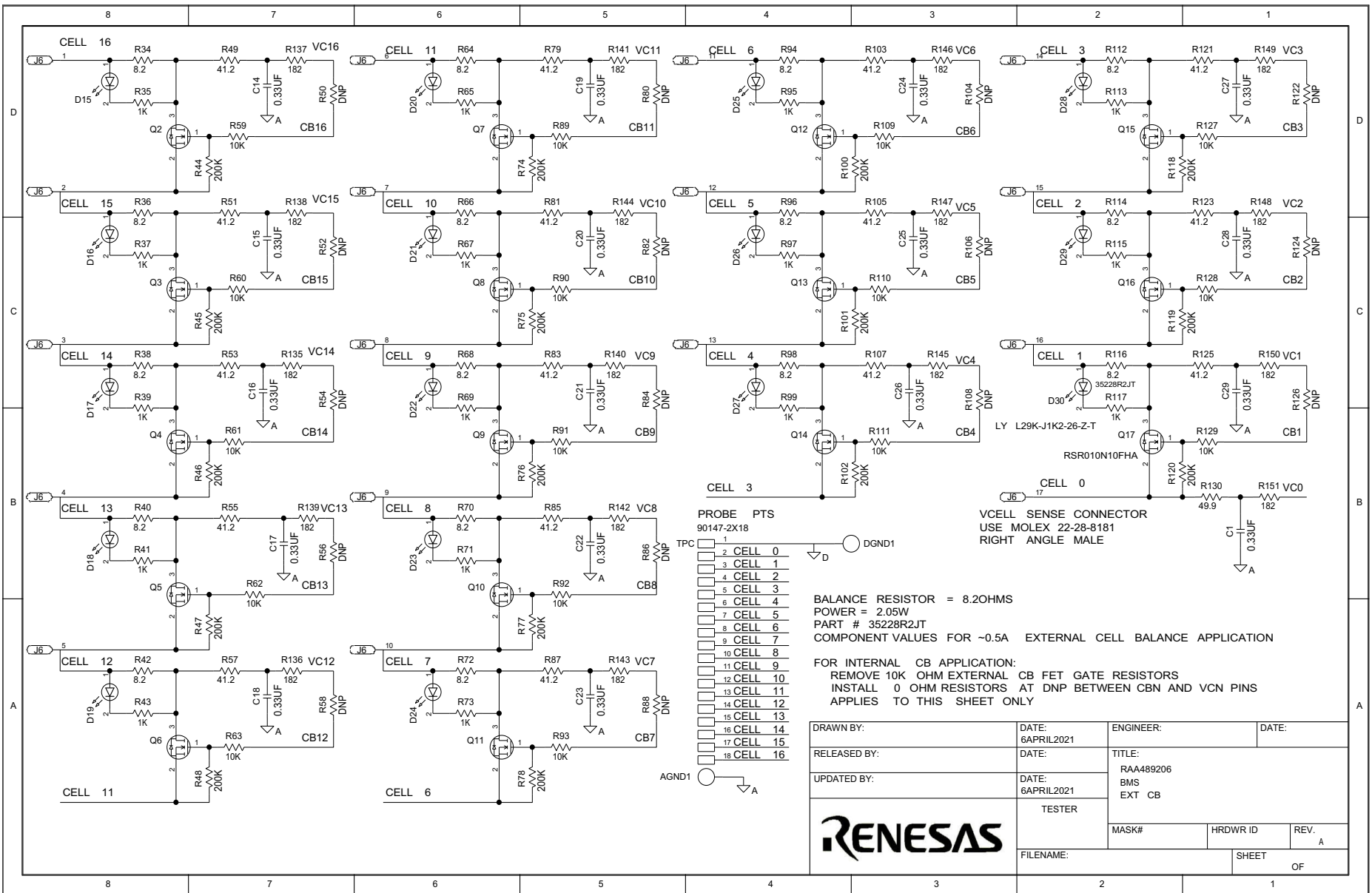

DRAWN BY:	DATE: 6APRIL2021	ENGINEER:	DATE:
RELEASED BY:	DATE:	TITLE: RAA489206 BMS EXT CB	
UPDATED BY:	DATE: 6APRIL2021	TESTER:	
		MASK#	HRDWR ID
		FILENAME:	REV. A
		SHEET	OF

Figure 72. Eval Board Schematic Sheet 2

8.2 RTKA489206DE0000BU Bill of Materials

Qty	Reference Designator	Description	Manufacturer	Manufacturer Part Number
1		PWB-PCB, RTKA489206DE0000BU, REVA, ROHS	MTL (Multilayer PCB International)	RTKA489206DE0000BURVAPCB
4	C31, C32, C33, C34	CAP-AEC-Q200, SMD, 0805, 47pF, 100V, 10%, C0G/NP0, ROHS	AVX	08051A470K4T4A
2	C6, C8	CAP, SMD, 0805, 1µF, 100V, 20%, X7S, ROHS	TDK	C2012X7S2A105M125AB
2	C5, C9	CAP, SMD, 0402, 0.01µF, 25V, 10%, X7R, ROHS	Murata	GRM155R71E103KA01D
1	C3	CAP, SMD, 0805, 1000pF, 100V, 10%, X7R, ROHS	Venkel	C0805X7R101-102KNE
3	C2, C4, C11	CAP, SMD, 0805, 0.1µF, 100V, 10%, X7R, ROHS	TDK	C2012X7R2A104K
1	C12	CAP, SMD, 0805, 0.1µF, 50V, 5%, X7R, ROHS	Kemet	C0805C104J5RACTU
2	C13, C30	CAP, SMD, 0805, 10µF, 25V, 10%, X5R, ROHS	TDK	C2012X5R1E106K085AC
1	C10	CAP, SMD, 1206, 1µF, 100V, 10%, X7R, ROHS	Venkel	C1206X7R101-105KNE
17	a) C1, C14, C15, C16, C17, C18, C19, C20, C21,	CAP, SMD, 1206, 0.33µF, 100V, 10%, X7R, ROHS	Kemet	C1206C334K1RACAUTO
0	b) C22, C23, C24, C25, C26, C27, C28, C29	CAP, SMD, 1206, 0.33µF, 100V, 10%, X7R, ROHS	Kemet	C1206C334K1RACAUTO
1	C7	CAP, SMD, 1210, 0.47µF, 100V, 10%, X7R, ROHS	Venkel	C1210X7R101-474KNE
1	J6	CONN-HEADER, 1x17, BRKAWY, R/A, 2.54mm, ROHS	Molex	22-28-8171
8	P+, P-, CSB, CST, VDD, AGND1, DGND1, DGND2	CONN-MINI TEST POINT, VERTICAL, WHITE, ROHS	Keystone	5002
2	J1, J5	CONN-HEADER, 1x3, BREAKAWY 1x36, 2.54mm, ROHS	BERG/FCI	68000-236HLF
1	J11	CONN-HEADER, TH, R/A, 1X16, BRKAWAY, 2.54mm, TIN, ROHS	FCI/BERG	68015-416HLF
3	J9, J10, CS	CONN-HEADER, 1X2, RETENTIVE, 2.54mm, 0.230x0.120, ROHS	BERG/FCI	69190-202HLF
2	D4, D7	DIODE-ZENER, DUAL ARRAY, SMD, SOT-23, 16V, 5%, 300mW, ROHS	Diodes Inc.	AZ23C16-7-F

Qty	Reference Designator	Description	Manufacturer	Manufacturer Part Number
2	D2, D11	DIODE-SCHOTTKY, SMD, SOD-123, 100V, 0.15A, ROHS	Diodes Inc.	BAT46W-E3-08
3	D1, D6, D14	LED-SMART, SMD, 0603, GREEN, 1.7V, 2mA, 570nm, 3.9mcd, ROHS	Osram	LGL29K-G2J1-24-Z
2	D5, D10	LED-SMART, SMD, 0603, 2P, RED, 1.8V, 2mA, 630nm, 4.5mcd, ROHS	Osram	LSL29K-G1J2-1-0-2-R18-Z
17	D13, D15-D30	LED-SMART, SMD, 0603, YELLOW, 1.8V, 2mA, 587nm, 7.9mcd, ROHS	Osram	LY L29K-J1K2-26-Z
1	U1	IC-16-CELL STANDALONE BATTERY MONITOR, SMD, 64P, QFN, 9x9, ROHS	Renesas Electronics	RAA4892062GNP#HA5
1	D9	DIODE-TVS, UNIDIRECTIONAL, SMD, SMA, 58V, 400W, ROHS	Liteon/Vishay	SMAJ58A
1	Q1	TRANSISTOR-NPN, SMD, SOT-223, 100V, 6A, 3W, ROHS	Diodes/Zetex	FZT853TA
2	CFET, DFET	TRANSISTOR-MOS, N-CHANN, SMD, HSOF-8, 100V, 300A, ROHS	Infineon Technology	IPT015N10N5ATMA1
16	Q2, Q3, Q4, Q5, Q6, Q7, Q8, Q9, Q10, Q11, Q12, Q13, Q14, Q15, Q16, Q17	TRANSISTOR-MOS, N-CHANNEL, SMD, 3P, TSMT, 100V, 1A, ROHS	ROHM	RSR010N10FHATL
16	R34, R36, R38, R40, R42, R64, R66, R68, R70, R72, R94, R96, R98, R112, R114, R116	RES, SMD, 2512, 8.2Ω, 3W, 5%, TF, ROHS	TE Connectivity	35228R2JT
6	R3-R5, R131-R133	RES-AEC-Q200, SMD, WIDE 2728, 0.03Ω, 4W, 1%, 15ppm, ROHS	Stackpole	CSSH2728FT30L0
0	R50, R52, R54, R56, R58, R80, R82, R84, R86, R88, R104, R106, R108, R122, R124, R126	RESISTOR, SMD, 0603, 0.1%, MF, DNP-PLACE HOLDER		
1	R16	RES, SMD, 0805, 10Ω, 1/8W, 1%, TF, ROHS	Venkel	CR0805-8W-10R0FT
24	a) R20, R23, R24, R25, R30, R31, R32, R33, R35, R37, R39, R41, R43, R65, R67, R69, R71, R73, R95, R97, R99, R113, R115, R117	RES, SMD, 0805, 1k, 1/8W, 1%, TF, ROHS	Venkel	CR0805-8W-1001FT

Qty	Reference Designator	Description	Manufacturer	Manufacturer Part Number
20	R7, R8, R12, R14, R59, R60, R61, R62, R63, R89, R90, R91, R92, R93, R109, R110, R111, R127, R128, R129	RES, SMD, 0805, 10k, 1/8W, 1%, TF, ROHS	Venkel	CR0805-8W-1002FT(PbFREE)
4	R19, R21, R22, R26	RES, SMD, 0805, 100k, 1/8W, 1%, TF, ROHS	Venkel	CR0805-8W-1003FT
2	R152, R153	RES, SMD, 0805, 1M, 1/8W, 1%, TF, ROHS	Vishay/Dale	CRCW08051M00FKEA
17	R135-R151	RES, SMD, 0805, 182Ω, 1/8W, 1%, TF, ROHS	Panasonic	ERJ-6ENF1820V
3	R10, R11, R27	RES, SMD, 0805, 200Ω, 1/8W, 1%, TF, ROHS	Panasonic	ERJ-6ENF2000V
16	R44-R48, R74-R78, R100-R102, R118-R120	RES, SMD, 0805, 200k, 1/8W, 1%, TF, ROHS	Venkel	CR0805-8W-2003FT
2	R1, R6	RES, SMD, 0805, 30.1Ω, 1/8W, 1%, TF, ROHS	Venkel	CR0805-8W-30R1FT(PbFREE)
16	R49, R51, R53, R55, R57, R79, R81, R83, R85, R87, R103, R105, R107, R121, R123, R125	RES, SMD, 0805, 41.2Ω, 1/8W, 1%, TF, ROHS	Yageo	RC0805FR-0741R2L
2	R28, R29	RES, SMD, 0805, 4.7k, 1/8W, 1%, TF, ROHS	Venkel	CR0805-8W-4701FT(PbFREE)
1	R130	RES, SMD, 0805, 49.9Ω, 1/8W, 1%, TF, ROHS	Rohm	MCR10EZH49R9
1	R15	RES, SMD, 1206, 3.3Ω, 1/4W, 1%, TF, ROHS	Yageo	RC1206FR-073R3L
1	R17	RES, SMD, 1210, 0Ω, 1/4W, TF, ROHS	Venkel	CR1210-4W-000
1	R18	RES, SMD, 2512, 300Ω, 1W, 1%, TF, ROHS	Panasonic	ERJ-1TNF3000U
1	S1	SWITCH-DIP, SLIDE, SMD, 6POS, SPST, 24V, 100mA, TOP SLIDE, ROHS	TE Connectivity	1825057-5
2	RESET#, WAKEUP#	SWITCH-PUSH, SMD, 6MM, OFF-MOM, SPST-NO, 100GF, ROHS	Omron	B3FS-1000P
1	SW1	SWITCH-SLIDE, SMD, 5.4X5.2, 2POS, SPDT, ROHS	Copal Electronics	CAS-D20TA
4	Bottom near four corners	BUMPS, 0.44inWx0.20inH, CYLINDRICAL DOME, BLK, ROHS	3M	SJ-5003 (BLACK)

Qty	Reference Designator	Description	Manufacturer	Manufacturer Part Number
0	D3 (SMAJ58A)	DO NOT POPULATE OR PURCHASE		
0	D8 (V15P8-M3)	DO NOT POPULATE OR PURCHASE		
0	J2, J3, J7, J8 (KPA8CTP)	DO NOT POPULATE OR PURCHASE		
0	J4	DO NOT POPULATE OR PURCHASE		
0	R154 (PWR163S-25-300F)	DO NOT POPULATE OR PURCHASE		
0	TPC	DO NOT POPULATE OR PURCHASE		
2	R9, R13	THERMISTOR-NTC, SMD, 0603, 10K, 1%, - 40+125C, ROHS	Murata	NCP18XH103F03RB
1	F1	FUSE, SMD, 9.5x5.0x2.0, 65A, 62V, ROHS	Dexerials Corp.	PSK-062065

9. Ordering Information

Part Number	Description
RTKA489206DK0000BU	RAA489206 evaluation kit

10. Revision History

Revision	Date	Description
1.01	Oct 7, 2022	Changed VBAT voltage from 55V to 59V throughout document.
1.00	Jun 22, 2021	Initial release

Appendix A

The values displayed in the following images are the device settings following Basic Init.

- The **Reg Map** tab (Figure 73) displays the values of all of the user registers in hex
- The **Read All Reg** button reads the registers from the device and updates the GUI with these values.
- The **Write All Reg** button writes the GUI displayed values to the device registers.
- The **Read Sheet** button updates the register map with the data stored in the configuration sheet corresponding to whichever option is selected in the **Sheet Select** box. This only updates the values displayed in the **Register Map** tab of the GUI, it does not change the values in the device.
- The **Write To Sheet** button modifies the configuration sheet corresponding to the **Sheet Select** option with values from the GUI **Register Map**. Examine the Configuration sheets carefully, as not every register is contained within them.

Meas	System	Voltage	IPack	ITemp/Reg	Aux	CB	GPIO	Status	Reg Map	Dongle
Register Map										
0x00: 0xF0	0x15: 0xFF	0x2A: 0x00	0x3F: 0x43	0x54: 0x00	0x69: 0x00					
0x01: 0x02	0x16: 0x00	0x2B: 0xFF	0x40: 0xB7	0x55: 0x00	0x83: 0xFF					
0x02: 0x80	0x17: 0xFF	0x2C: 0x00	0x41: 0x05	0x56: 0x00	0x84: 0xFF					
0x03: 0x80	0x18: 0x00	0x2D: 0xFF	0x42: 0xB7	0x57: 0x0E	0x85: 0xFE					
0x04: 0xFF	0x19: 0xFF	0x2E: 0x5B	0x43: 0x06	0x58: 0x63	0x86: 0xFF					
0x05: 0xFF	0x1A: 0x00	0x2F: 0x00	0x44: 0xB7	0x59: 0x8F	0x87: 0xFF					
0x06: 0xFF	0x1B: 0x32	0x30: 0xB6	0x45: 0x49	0x5A: 0x63	0x88: 0xFF					
0x07: 0x00	0x1C: 0x00	0x31: 0xE7	0x46: 0xB7	0x5B: 0x6F	0x89: 0xFF					
0x08: 0xFF	0x1D: 0xFF	0x32: 0xB7	0x47: 0x1F	0x5C: 0xB6						
0x09: 0x00	0x1E: 0xFF	0x33: 0x42	0x48: 0xB7	0x5D: 0xF8						
0x0A: 0x0F	0x1F: 0xC0	0x34: 0xB6	0x49: 0x11	0x5E: 0x95						
0x0B: 0xFF	0x20: 0xFF	0x35: 0xA7	0x4A: 0xB6	0x5F: 0x78						
0x0C: 0x00	0x21: 0x00	0x36: 0xB6	0x4B: 0xC1	0x60: 0x7E						
0x0D: 0x00	0x22: 0x4D	0x37: 0xD6	0x4C: 0xB6	0x61: 0x0D						
0x0E: 0xB4	0x23: 0x41	0x38: 0xB7	0x4D: 0xD1	0x62: 0xE8						
0x0F: 0xFF	0x24: 0x5C	0x39: 0x00	0x4E: 0xB7	0x63: 0x00						
0x10: 0x00	0x25: 0x01	0x3A: 0xB7	0x4F: 0x2F	0x64: 0x00						
0x11: 0xC0	0x26: 0x00	0x3B: 0x6F	0x50: 0x00	0x65: 0x20						
0x12: 0x1F	0x27: 0x00	0x3C: 0xB7	0x51: 0xD8	0x66: 0x01						
0x13: 0xFF	0x28: 0x00	0x3D: 0x7F	0x52: 0xFF	0x67: 0x00						
0x14: 0x00	0x29: 0x00	0x3E: 0xB7	0x53: 0xFC	0x68: 0x00						

Sheet Select

Config 3 Config 4
 Config 1 Config 2

Figure 73. Reg Map Tab

The Configuration sheets (Figure 74) can be found in the excel workbook that contains the GUI. These sheets allow you to save and access multiple complete device configurations and switch between them quickly.

StartingSheet	Configuration 1	Configuration 2	Configuration 3	Configuration 4	Variables	GraphSheet
---------------	------------------------	-----------------	-----------------	-----------------	-----------	------------

Figure 74. Configuration Tabs

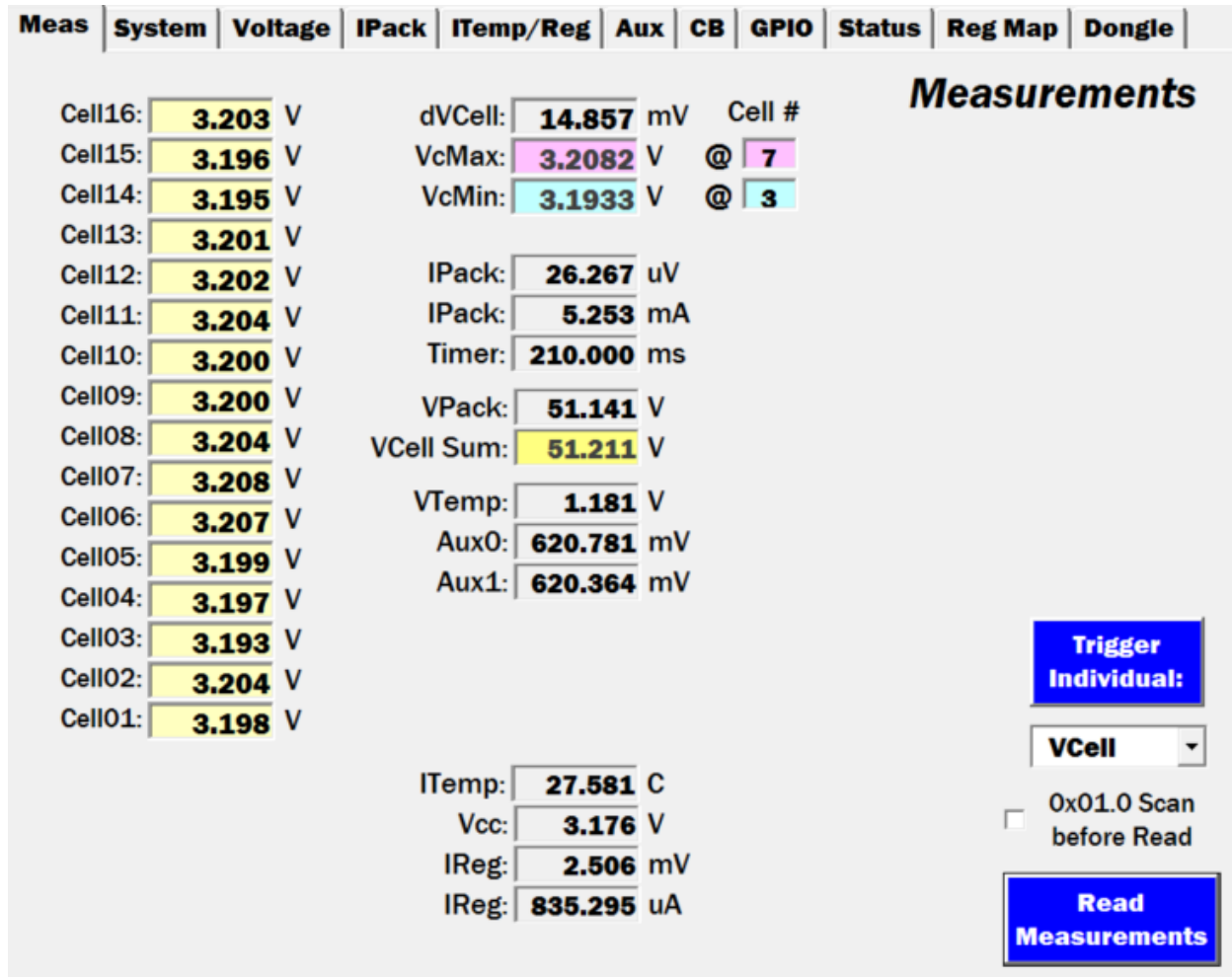

Figure 75. MEAS Tab

The **Meas** tab (Figure 75) allows you to see the RAA489206 measurement results obtained during a system or an individual triggered scan.

The IPack current is calculated by dividing the IPack voltage by the RSense resistor value stored on the **IPack** tab.

The IReg current is calculated by dividing the IReg voltage by the IReg Sense R resistor value on the **ITemp/Reg** tab.

The screenshot shows the 'System' tab of a software interface. At the top, there is a navigation bar with tabs: Meas, System, Voltage, IPack, ITemp/Reg, Aux, CB, GPIO, Status, Reg Map, and Dongle. The 'System' tab is active.

0x04-05 Cell Select

Select Cells

Cell16	1	1	1	1	1	1	1	1
Cell8	1	1	1	1	1	1	1	1

0x2E Scan Operation

Mode: **SCAN**

Low Power Timer: **2048 scan**

Scan Delay: **256ms**

Bit 7 0x09.5 Other Fault Delay

Bit 0

0x01 Global Operation

- 7 Soft Reset
- 6 Reset to IDLE
- 5 RCAL Vos Trigger
- 4 RCAL LPM
- 3 RCAL Scan
- 2 BUSY
- 1 Scan Select
- 0 Sys Trigger

Updates

0x1B.5:4 Other: **65 scans**

0x03.6:5 OW: **33 scans**

LP Mode

- 0x1B.1 LP REG
- 0x0E.1 LDLP
- 0x1F.1 Comm TO Enable

Measure Enable Bits

- 0x02.7 VCell
- 0x03.7 IPack
- 0x1F.7 VBat
- 0x24.6 Open Wire
- 0x1F.6 ITemp
- 0x11.7:6 Aux: **BOTH**

Measure Averaging

0x02.4:2 VCell: **1** Scans

0x03.4:2 IPack: **1** Scans

0x11.4:2 Aux: **1** Scans

0x1F.4:2 Other: **1** Scans

Buttons: **Write**, **Read**, **Read Page**

Figure 76. System Tab

The **System** tab (Figure 76) contains various settings related to overall system behavior. These include which cells are enabled, the Scan and Global operations registers, which measurements are enabled during a scan, Low Power Mode Options, Measure Averaging Options, and how frequently certain values are updated during a continuous scan.

Meas	System	Voltage	IPack	ITemp/Reg	Aux	CB	GPIO	Status	Reg Map	Dongle
VPack Threshold Limits										
0x20 VBat1 OV Threshold		<input type="text" value="77.120"/> V = 0xFF	0x65.7 VBOVF		<input type="text" value="0"/>					
0x21 VBat1 UV Threshold		<input type="text" value="0.301"/> V = 0x0	0x65.6 VBUVF		<input type="text" value="0"/>					
<input type="button" value="Write Thresh"/>		<input type="button" value="Read"/>		<input checked="" type="checkbox"/> 0x24.3 VPack Connect						
VCell Threshold Limits										
0x06 OV Threshold		<input type="text" value="4.82"/> V = 0xFF	0x09.3:0 OV/UV Delay		0x63.0 OVF		<input type="text" value="0"/>		<input type="checkbox"/> 0x02.6 DCHRWOV	
0x07 UV Threshold		<input type="text" value="0.000037"/> V = 0x0	<input type="text" value="1"/> scan(s)		0x63.1 UVF		<input type="text" value="0"/>		<input type="checkbox"/> 0x02.5 CHRWUV	
0x08 dVCell Threshold		<input type="text" value="4.82"/> V = 0xFF	0x09.6 dVCell Delay		0x66.3 DVCF		<input type="text" value="0"/>			
<input type="button" value="Write Thresh"/>		<input type="button" value="Read"/>		<input checked="" type="checkbox"/> 0x24.4 VCell Connect						

Figure 77. Voltage Tab

The **Voltage** tab (Figure 77) allows you to view and change various thresholds and settings related to both Pack and Cell voltage settings. For VPack, you can set the Pack Overvoltage and Undervoltage fault thresholds, and VPack Connect allows you to control if these faults disable the power FETs. For VCell, you can set the Cell Overvoltage and Undervoltage thresholds, and the maximum cell differential voltage. Also, you can control how many consecutive scans a Cell OV/UV or Cell Delta Voltage fault must be detected before the fault bit is set. When VCell Connect is enabled, it allows detections of OVF, UVF, and DVCF to turn off the Power FETs. DCHRWOV allows discharging while a cell overvoltage condition is present and CHRWUV allows charging while a cell undervoltage condition is present.

Meas	System	Voltage	IPack	ITemp/Reg	Aux	CB	GPIO	Status	Reg Map	Dongle
-------------	---------------	----------------	--------------	------------------	------------	-----------	-------------	---------------	----------------	---------------

IPack OC Thresholds

0x0B DOC Threshold <input type="text" value="-342.996"/> mV = 0xFF	0x0D.7:4 DOC Delay <input type="text" value="1"/> scan(s) = 0x00	<input checked="" type="checkbox"/> 0x0E.7 DOCF Connect	0x63.3 DOCF <input type="text" value="0"/>
0x0F COC Threshold <input type="text" value="342.996"/> mV = 0xFF	0x0D.3:0 COC Delay <input type="text" value="1"/> scan(s)	<input checked="" type="checkbox"/> 0x0E.2 COCF Connect	0x63.4 COCF <input type="text" value="0"/>

Write Thresh

Read

IPack, DSC, LDMON and WAKE UP Thresholds

0x0A.3:0 DSC = 0x0F <input type="text" value="-642.66672"/> mV	0x0C.6:0 DSC Delay <input type="text" value="1"/> us	0x03.1 IDir Delay <input type="text" value="1scans"/>	0x63.2 DSCF <input type="text" value="0"/>
0x0E.6:5 Enable Load Detect <input type="text" value="1M Pull Up"/>	0x1B.3:2 Ld Det Delay <input type="text" value="250ms"/>	RSense <input type="text" value="0.005"/> Ω	<input type="checkbox"/> 0x0E.4 ELR

Write Thresh

Read

0x67.5 CH PRESI
 0x67.4 LD PRESI

Figure 78. IPack Tab

The **IPack** tab (Figure 78) contains various IPack control options. The **IPack OC Thresholds** section allows you to view and adjust settings related to charge overcurrent and discharge overcurrent conditions. The **IPack, DSC, LDMON and WAKE UP Thresholds** allow you to adjust other pack current and load detection related settings. Importantly, this is where you can set the RSense value that the GUI uses to calculate the current displayed on the **Meas** tab. Press **Write Thresh** to move the new values into the device after changing them on the GUI.

Meas	System	Voltage	IPack	ITemp/Reg	Aux	CB	GPIO	Status	Reg Map	Dongle
------	--------	---------	-------	-----------	-----	----	------	--------	---------	--------

Internal Temperature Threshold Limits

0x22 IOTW Threshold
 C = 0x4D 0x66.6 IOTW

0x23 IOTF Threshold
 C = 0x41 0x63.5 IOTF

Write Thresh **Read**

Regulator

0x1C VCC Min Threshold
 V = 0x0 0x63.7 VCCF

0x1D IRegOC1 Threshold
 mV = 0xFF IReg Sense R 0x67.2 IREG1

Ω

0x1E IRegOC2 Threshold
 mV = 0xFF 0x67.1 IREG2

Write Thresh **Read**

Figure 79. ITEMP/Reg Tab

The **ITemp/Reg** tab (Figure 79) allows you to view and modify settings related to the internal temperature fault thresholds and regulator thresholds.

The IReg Sense R resistor value is set in this tab, which is used to calculate the IReg current value displayed on the **Meas** tab. Press **Write Thresh** to store the value after changing it. This resistor is 3.3Ω on stock RevC EVKITS. Check R15 on the evaluation board to be certain, it is nearest to the lower right corner of the RAA489206.

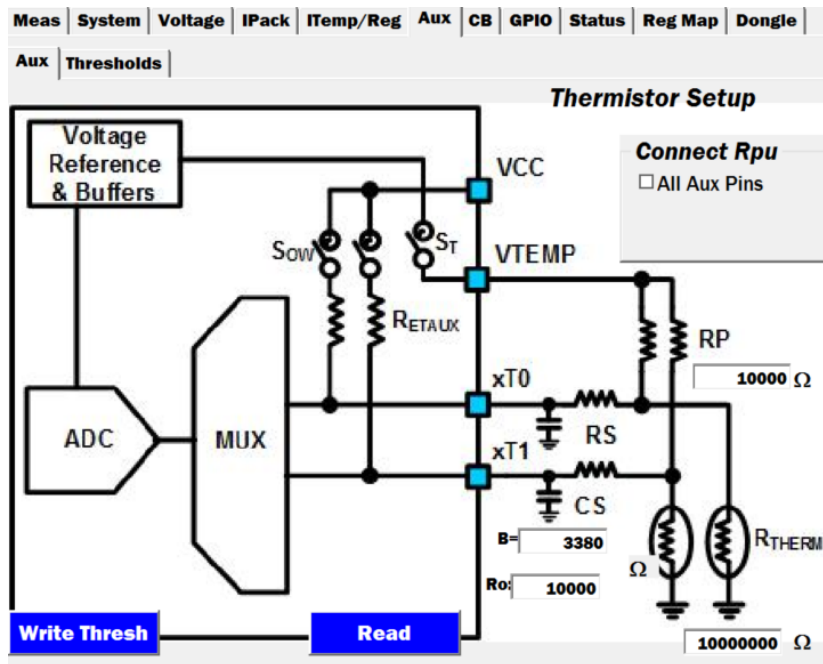

Figure 80. AUX/AUX tab

The **Aux** tab is composed of two sub-tabs related to the external thermistors.

The **Aux** sub-tab (Figure 80) allows you to view and modify various component values related to the thermistors.

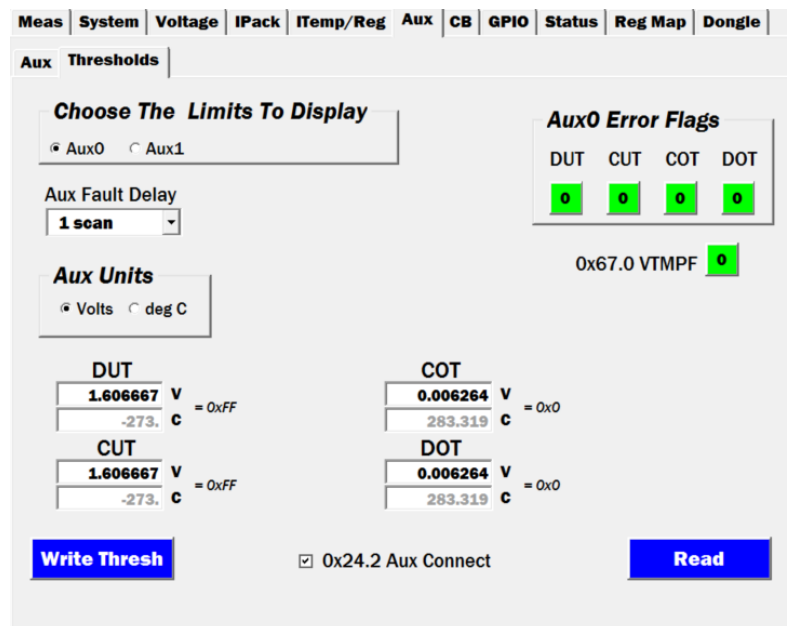

Figure 81. AUX Thresholds Tab

The **Thresholds** sub-tab (Figure 81) allows you to view and modify various auxiliary related fault settings. Aux Connect controls if an Aux related fault disables the power FETs.

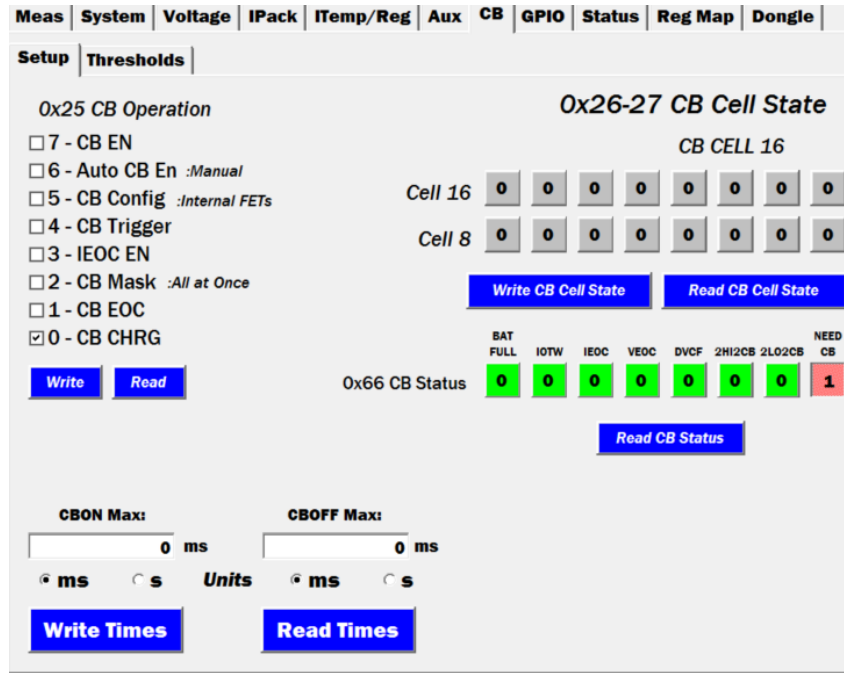

Figure 82. CB Setup Tab

The **CB** tab is composed of two Cell Balancing related sub-tabs.

The **Setup** sub-tab (Figure 82) allows you to view and adjust various cell balancing related settings. Importantly, this is where the CB Operation register is controlled from. To understand how this register controls Cell Balancing consult the datasheet.

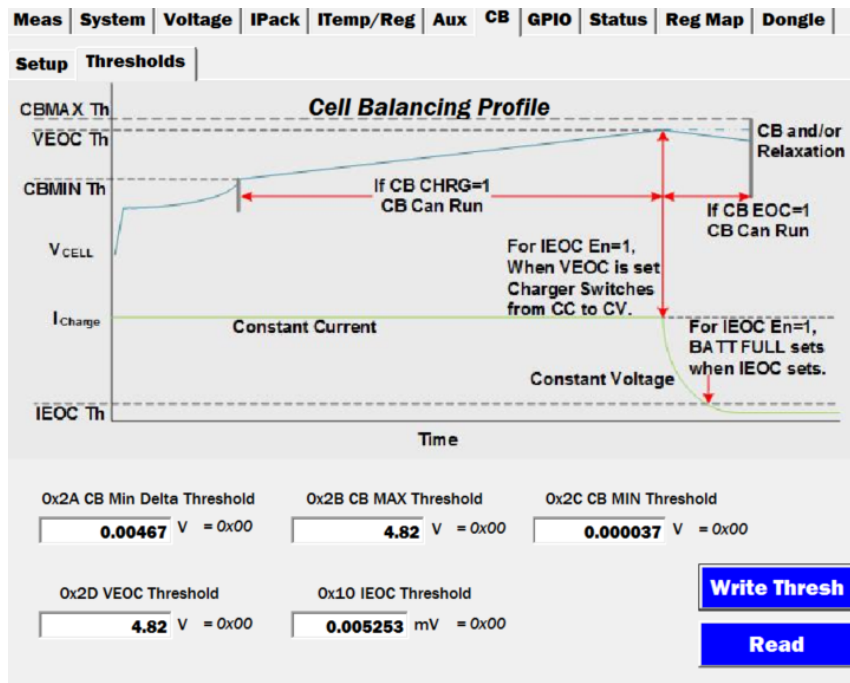

Figure 83. CB Thresholds Tab

The **Thresholds** sub-tab (Figure 83) allows you to view and adjust various cell balancing and charging related thresholds. There is also a charging profile that provides insight into what each of these thresholds represents.

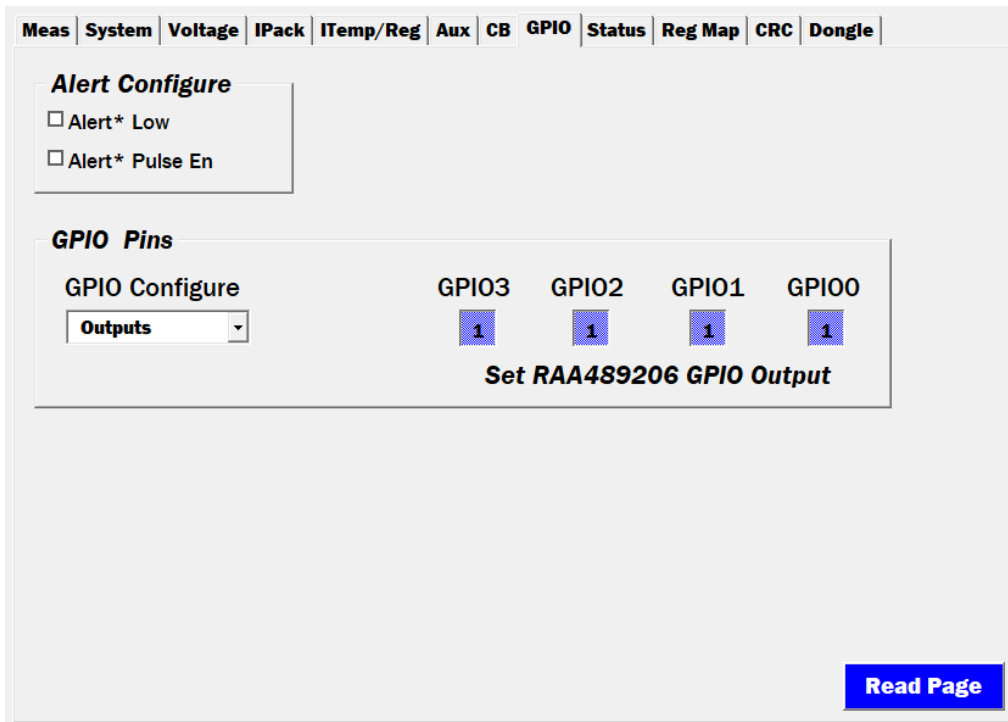

Figure 84. GPIO Tab

The **GPIO** tab (Figure 84) allows you to either view or control the status of the RAA489206 GPIO pins, depending on the configuration. The tab also allows you to select from the various GPIO configurations for the device. See the datasheet for the various GPIO configurations and operation.

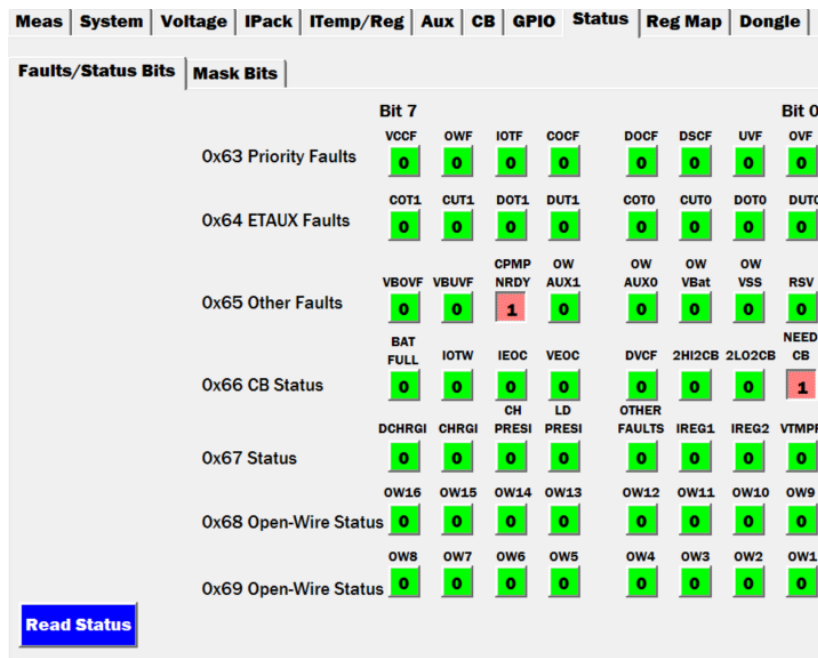

Figure 85. Faults/Status Bits Tab

The **Status** tab is comprised of two sub-tabs.

The **Faults/Status Bits** sub-tab (Figure 85) displays the status of the various faults and status bits contained in the RAA489206.

Meas	System	Voltage	IPack	ITemp/Reg	Aux	CB	GPIO	Status	Reg Map	CRC	Dongle
------	--------	---------	-------	-----------	-----	----	------	--------	---------	-----	--------

Serial Communication

I2C SPI

Configure Pins			Pin Value		
	Open Drain	Push Pull	Low (0)	High (1)	
CS:	<input type="radio"/>	<input checked="" type="radio"/>	<input type="radio"/>	<input checked="" type="radio"/>	
ALRT:	<input checked="" type="radio"/>	<input type="radio"/>	<input type="radio"/>	<input checked="" type="radio"/>	
RESET:	<input checked="" type="radio"/>	<input type="radio"/>	<input type="radio"/>	<input checked="" type="radio"/>	
WK UP:	<input checked="" type="radio"/>	<input type="radio"/>	<input type="radio"/>	<input checked="" type="radio"/>	
CMS0:	<input type="radio"/>	<input checked="" type="radio"/>	<input type="radio"/>	<input checked="" type="radio"/>	
CMS1:	<input type="radio"/>	<input checked="" type="radio"/>	<input checked="" type="radio"/>	<input type="radio"/>	
ALRT2:	<input checked="" type="radio"/>	<input type="radio"/>	<input type="radio"/>	<input checked="" type="radio"/>	
LED FRQ:	<input type="text" value="3.922"/>	kHz	<input checked="" type="radio"/>	<input type="radio"/>	
			LD	<input type="radio"/>	<input checked="" type="radio"/>
			REG EN:	<input type="radio"/>	<input checked="" type="radio"/>
GPIO0:	<input checked="" type="radio"/>	<input type="radio"/>	GPIO0:	<input type="radio"/>	<input checked="" type="radio"/>
GPIO1:	<input checked="" type="radio"/>	<input type="radio"/>	GPIO1:	<input type="radio"/>	<input checked="" type="radio"/>
GPIO2:	<input checked="" type="radio"/>	<input type="radio"/>	GPIO2:	<input type="radio"/>	<input checked="" type="radio"/>
GPIO3:	<input checked="" type="radio"/>	<input type="radio"/>	GPIO3:	<input type="radio"/>	<input checked="" type="radio"/>
GPIO4:	<input checked="" type="radio"/>	<input type="radio"/>	GPIO4:	<input checked="" type="radio"/>	<input type="radio"/>
GPIO5:	<input checked="" type="radio"/>	<input type="radio"/>	GPIO5:	<input checked="" type="radio"/>	<input type="radio"/>
GPIO6:	<input checked="" type="radio"/>	<input type="radio"/>	GPIO6:	<input checked="" type="radio"/>	<input type="radio"/>

Pull-Up Reg Voltage

5.0V 3.3V

2.5V OPEN

Serial Com Speed

I2C Freq: MHz

SPI Freq: MHz

Figure 87. Dongle Tab

The **Dongle** tab (Figure 87) allows you to view and modify the settings of the ISO-DONGLE-EV1Z communications dongle.

IMPORTANT NOTICE AND DISCLAIMER

RENESAS ELECTRONICS CORPORATION AND ITS SUBSIDIARIES (“RENESAS”) PROVIDES TECHNICAL SPECIFICATIONS AND RELIABILITY DATA (INCLUDING DATASHEETS), DESIGN RESOURCES (INCLUDING REFERENCE DESIGNS), APPLICATION OR OTHER DESIGN ADVICE, WEB TOOLS, SAFETY INFORMATION, AND OTHER RESOURCES “AS IS” AND WITH ALL FAULTS, AND DISCLAIMS ALL WARRANTIES, EXPRESS OR IMPLIED, INCLUDING, WITHOUT LIMITATION, ANY IMPLIED WARRANTIES OF MERCHANTABILITY, FITNESS FOR A PARTICULAR PURPOSE, OR NON-INFRINGEMENT OF THIRD PARTY INTELLECTUAL PROPERTY RIGHTS.

These resources are intended for developers skilled in the art designing with Renesas products. You are solely responsible for (1) selecting the appropriate products for your application, (2) designing, validating, and testing your application, and (3) ensuring your application meets applicable standards, and any other safety, security, or other requirements. These resources are subject to change without notice. Renesas grants you permission to use these resources only for development of an application that uses Renesas products. Other reproduction or use of these resources is strictly prohibited. No license is granted to any other Renesas intellectual property or to any third party intellectual property. Renesas disclaims responsibility for, and you will fully indemnify Renesas and its representatives against, any claims, damages, costs, losses, or liabilities arising out of your use of these resources. Renesas' products are provided only subject to Renesas' Terms and Conditions of Sale or other applicable terms agreed to in writing. No use of any Renesas resources expands or otherwise alters any applicable warranties or warranty disclaimers for these products.

(Rev.1.0 Mar 2020)

Corporate Headquarters

TOYOSU FORESIA, 3-2-24 Toyosu,
Koto-ku, Tokyo 135-0061, Japan
www.renesas.com

Contact Information

For further information on a product, technology, the most up-to-date version of a document, or your nearest sales office, please visit:
www.renesas.com/contact/

Trademarks

Renesas and the Renesas logo are trademarks of Renesas Electronics Corporation. All trademarks and registered trademarks are the property of their respective owners.