

RX24T CPU Card User's Manual

R20UT3696EJ0130

Rev.1.30

2022.2.21

User's Manual

For Your Safety



Do not fail to read this manual before using the RX24T CPU card (RTK0EM0009C03402BJ) (the product).

- Follow the indications in this manual when using the product.
- This product is an optional board for "Evaluation System for BLDC Motor (RTK0EMX270S00020BJ)" and "24V Motor Control Evaluation System for RX23T (RTK0EM0006S01212BJ)".
- Keep this manual near the product so you can refer to it whenever necessary.
- Transfer or sale of the product to third parties is prohibited without written approval.
- The product does not meet the legal requirements for general product safety (including EMC requirements) for equipment as stipulated by various countries and regions. The purchaser or importer of the product is responsible for ensuring compliance with local regulations. In addition, the customer is responsible for ensuring that the product is handled correctly and safely, in accordance with the laws of the customer's country (region).
- All information contained in this manual represents information on products at the time of publication of this manual. Please note that the product data, specification, sales offices, contents of website, address, etc., are subject to change by Renesas Electronics Corporation without notice due to product improvements or other reasons. Please confirm the latest information on Renesas Electronics website.
- The manual for the product, and specification (the documents) are the tool that was developed for the function and performance evaluation of Renesas Electronics semiconductor device (Renesas Electronics device) mounted on the product, and not guarantee the same quality, function and performance.
- By purchasing the product or downloading the documents from Renesas Electronics website, the support services provided from Renesas Electronics is not guaranteed.

Meaning of Notations

In this manual items related to the safe use of the product are indicated as described below.

The degree of injury to persons or damage to property that could result if the designated content in this manual is not followed is indicated as follows.

 Danger	Indicates content that, if not followed, could result in death or serious injury* ¹ to the user, and which is highly urgent.
 Warning	Indicates content that, if not followed, could result in death or serious injury to the user.
 Caution	Indicates content that, if not followed, could result in injury* ² to persons or physical damage.* ³

Note 1. Serious injury refers to conditions resulting in persistent after-effects and for which treatment would necessitate hospitalization or regular hospital visits, such as loss or impairment of eyesight, burns (high- or low-temperature), electric shock, bone fracture, or poisoning.

Note 2. Injury refers to conditions for which treatment would necessitate hospitalization or regular hospital visits.

Note 3. Physical damage refers to damage affecting the wider surroundings, such as the user's home or property.

Requirements related to the handling of the product are classified into the following categories.



- Marks indicating that an action is prohibited.

	<p>General Prohibition The indicated action is prohibited.</p>		<p>Example: Do Not Touch! Touching the specified location could result in injury.</p>
---	---	---	---

- Marks indicating that an action is prohibited.





	<p>General Caution Indicates a general need for caution that is not specified.</p>		<p>Example: Caution – Hot! Indicates the possibility of injury due to high temperature.</p>
---	---	---	---

- Marks directing that the specified action is required.







	<p>General Instruction The specified action is required.</p>		<p>Example: Turn Off (Disconnect) Power Supply! Instructs the user to turn off (disconnect) the power supply to the product.</p>
---	---	---	--

Warnings Regarding Use of the Product





■ Danger Items

 Danger	
  	<ul style="list-style-type: none"> The product should be used only by persons (users) having a thorough knowledge of electrical and mechanical components and systems, a full knowledge of the risks associated with handling them, and training in inverter motor control and handling motors, or equivalent skills. Users should be limited to persons who have carefully read the Caution Items contained in this manual. Unlike typical equipment, the product has no protective case to ensure safety, and it contains moving parts and high-temperature components that could be dangerous. Do not touch the evaluation board or cables while power is being supplied. Carefully check to make sure that there are no pieces of conductive materials or dust adhering to the board, connectors, and cables. There are moving parts, driven by a motor. Do not touch the motor while power is being supplied. Ensure that the motor is insulated and placed in a stable location before supplying power.
	<p>Do Not Connect Load to Motor!</p> <ul style="list-style-type: none"> This could cause fire, burns, or injury.

■ Warning Items

 Warning	
	<p>Caution – Rotating Parts!</p> <ul style="list-style-type: none"> The system includes a motor. Touching the rotating shaft could cause high-temperature burns or injury.
	<p>Always insert plugs, connectors, and cables securely, and confirm that they are fully inserted.</p> <ul style="list-style-type: none"> Incomplete connections could cause fire, burns, electric shock, or injury.
	<p>Use the power supply apparatus specified in the manual.</p> <ul style="list-style-type: none"> Failure to do so could cause fire, burns, electric shock, injury, or malfunction.
	<p>Disconnect the power supply and unplug all cables when the system will not be used for a period of time or when moving the system.</p> <ul style="list-style-type: none"> Failure to do so could cause fire, burns, electric shock, or malfunction. This will protect the system against damage due to lightning.
	<p>Use a mechanism (switch, outlet, etc.) located within reach to turn off (disconnect) the power supply.</p> <ul style="list-style-type: none"> In case of emergency, it may be necessary to cut off the power supply quickly.
	<p>Turn off the power supply immediately if you notice abnormal odor, smoke, abnormal sound, or overheating.</p> <ul style="list-style-type: none"> Continuing to use the system in an abnormal condition could cause fire, burns, or electric shock.
	<p>Do Not Disassemble, Modify, or Repair!</p> <ul style="list-style-type: none"> Doing so could cause fire, burns, electric shock, injury, or malfunction.
	<p>Do not use the product for any purpose other than initial evaluation of motor control in a testing room or lab. Do not integrate the product or any part of it into other equipment. Do not insert or remove cables or connectors when the product is powered on.</p> <ul style="list-style-type: none"> The product has no safety case. Failure to observe the above could cause fire, electric shock, burns, or malfunction. The product may not perform as expected if used for other than its intended purpose.

■ Caution Items

 Caution	
	<p>Caution – Hot!</p> <ul style="list-style-type: none"> The motor gets hot. Touching it could cause high-temperature burns.
	<p>Follow the procedure specified in the manual when powering the system on or off.</p> <ul style="list-style-type: none"> Failure to do so could cause overheating or malfunction.
	<p>Caution – Static Electricity</p> <ul style="list-style-type: none"> Use the antistatic band. Failure to do so could cause malfunction or unstable motion.

Overview

The RX24T CPU card (RTK0EM0009C03402BJ) is an optional board for the Evaluation System for BLDC Motor (RTK0EMX270S00020BJ) and the 24V Motor Control Evaluation System for RX23T (RTK0EM0006S01212BJ). By connecting this product to an inverter board (the INV-BRD), motor evaluation using RX24T becomes possible.

An emulator, INV-BRD, and equipment must be provided by the customer.

This user's manual describes the proper handling of the product.

Target Device

RX24T microcontroller

Related Documents

- RX24T CPU Card Schematic: R12TU0004EJ
- RX24T CPU Card BOM List: R12TU0002EJ
- RX24T CPU Card PWB Pattern Drawing: R12TU0003EJ
- Evaluation System for BLDC Motor User's Manual: R12UZ0062
- 24V Motor Control Evaluation System for RX23T User's Manual: R20UT3697EJ

Package Contents

Refer to "RX24T CPU Card Information" included with this document.

Abbreviations

Abbreviations	Full Name	Remarks
INV-BRD	Inverter Board	Inverter board included in "Evaluation System for BLDC Motor" (Board P/N.: RTK0EM0000B10020BJ) or Inverter board included in "24V Motor Control Evaluation System for RX23T" (Board P/N.: RTK0EM0001B00012BJ)
E1	E1 emulator	on-chip debugging emulator and flash programmer Product No.: R0E000010KCE00
E2 Lite	E2 emulator Lite	on-chip debugging emulator and flash programmer Product No.: RTE0T0002LKCE00000R

Contents

1. Specifications.....6

1.1 Specification.....6

1.2 Regulatory Compliance Notices.....7

1.2.1 European Union regulatory notices.....7

2. Block Diagram8

3. Layout9

4. Usage10

5. Functions.....11

5.1 Power Supply.....11

5.2 Connecting the Emulator11

5.3 Connecting the Inverter Board12

5.4 Connecting the SCI.....13

5.5 Hall Sensor Signal Input.....13

5.6 Encoder Signal Input14

5.7 Extension of Unused Pins.....15

5.8 Reset Circuit15

5.9 Crystal Resonator15

5.10 LEDs16

6. Details of RX24T CPU Card.....17

6.1 RX24T Features17

6.2 RX24T Pin Assignments.....18

6.3 List of RX24T Pin Functions20

7. Caution Items.....22

Revision History24

1. Specifications

1.1 Specification

Table 1.1 Overview of RX24T CPU Card Specifications

Item	Specification
Product name	RX24T CPU card
Board product No.	RTK0EM0009C03402BJ
Supported inverter board / product No.	Supplied with 24V Motor Control Evaluation System for RX23T 24V Inverter Board / RTK0EM0001B00012BJ Inverter board supplied with Evaluation System for BLDC Motor /RTK0EM0000B10020BJ

Exterior view

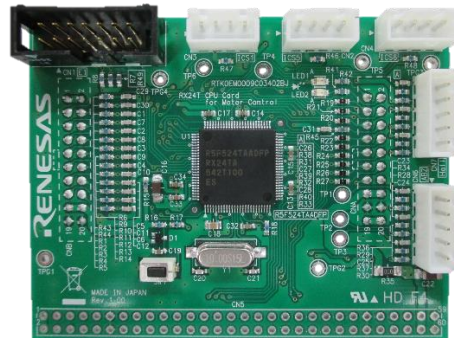

Note: Appearance of actual product may differ from photo.

MCU	Product group	RX24T group
	Product No.	R5F524TAADFP
	CPU max. operating frequency	80 MHz
	Bit count	32 bits
	Package / Pin count	LFQFP / 100 pins
	ROM	256 KB
	RAM	16 KB
MCU input clock	Crystal resonator 10 MHz	
Input power supply voltage	DC 5 V*1 Selectable among the following: <ul style="list-style-type: none"> • Power supply from supported inverter board • Power supply from supported emulator *2 	
Supported sensors	Hall sensor, encoder (through holes provided for signal monitoring test pins)	
Supported emulator	E1, E2 Lite	
Connectors	<ul style="list-style-type: none"> • Inverter board connectors × 2 • SCI connectors × 3 • E1 connector • Hall sensor signal input connector • Encoder signal input connector 	
Switch	MCU external reset switch	
LEDs	User control LEDs × 2	
Operating temperature	Room temperature	
Operating humidity	No condensation	

Note 1. Supply voltage is DC 3.3V from E2 Lite.

Note 2. Power supply from the supported emulator is only supported for standalone operation. Power supply from the supported emulator is not supported when the INV-BRD is connected.

1.2 Regulatory Compliance Notices

1.2.1 European Union regulatory notices

This product complies with the following EU Directives. (These directives are only valid in the European Union.)

CE Certifications:

- Electromagnetic Compatibility (EMC) Directive 2014/30/EU
EN61326-1 : 2013 Class A

WARNING: This is a Class A product. This equipment can cause radio frequency noise when used in the residential area. In such cases, the user/operator of the equipment may be required to take appropriate countermeasures under his responsibility.

- Information for traceability
 - Authorised representative
Name: Renesas Electronics Corporation
Address: Toyosu Foresia, 3-2-24, Toyosu, Koto-ku, Tokyo 135-0061, Japan
 - Manufacturer
Name: Renesas Electronics Corporation
Address: Toyosu Foresia, 3-2-24, Toyosu, Koto-ku, Tokyo 135-0061, Japan
 - Person responsible for placing on the market
Name: Renesas Electronics Europe GmbH
Address: Arcadiastrasse 10, 40472 Dusseldorf, Germany
 - Trademark and Type name
Trademark: Renesas
Product name: RX24T CPU Card for Motor Control
Type name: RTK0EM0009C03402BJ

Environmental Compliance and Certifications:

- Waste Electrical and Electronic Equipment (WEEE) Directive 2012/19/EU

2. Block Diagram

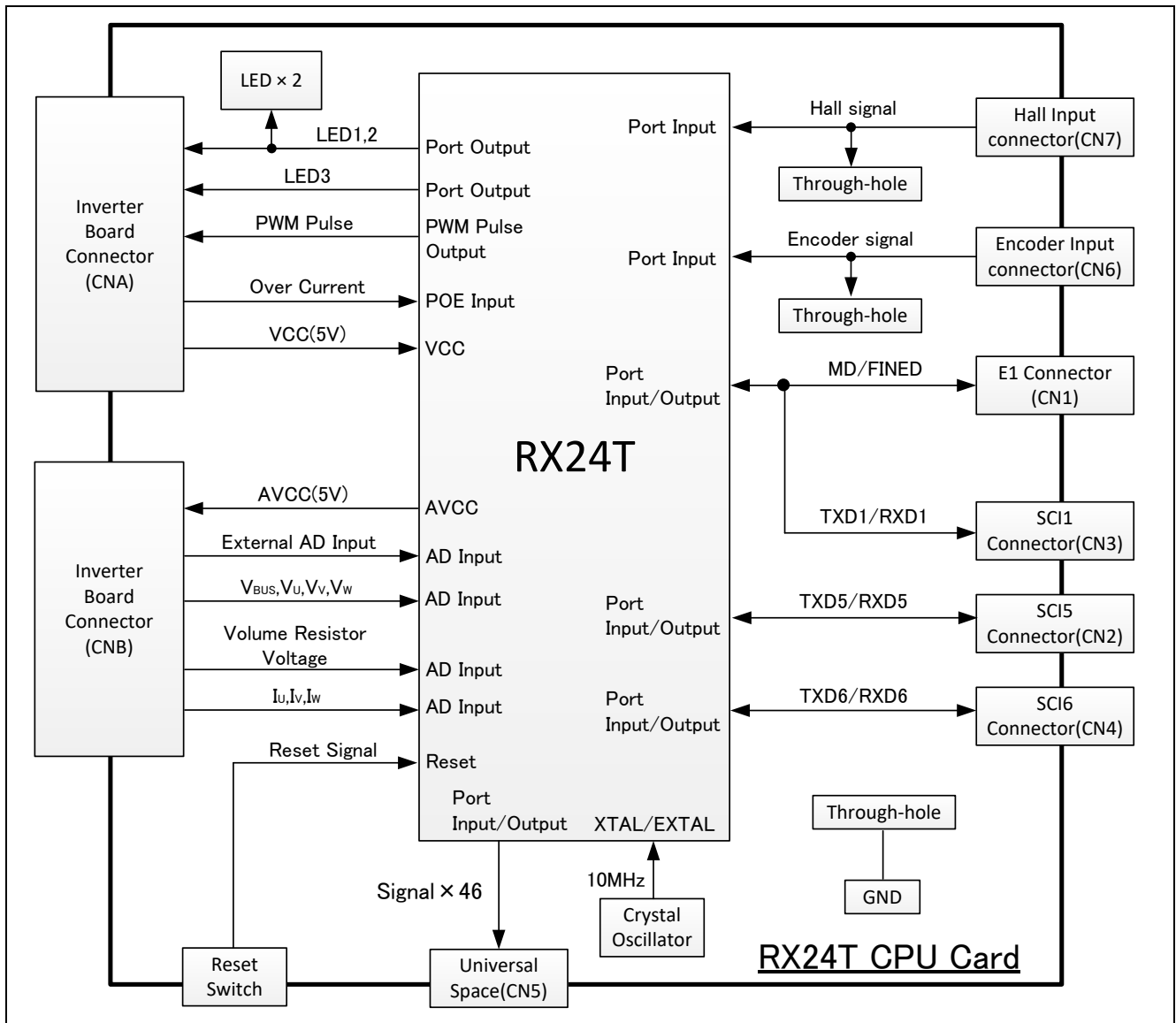

Figure 2.1 RX24T CPU Card Block Diagram

3. Layout

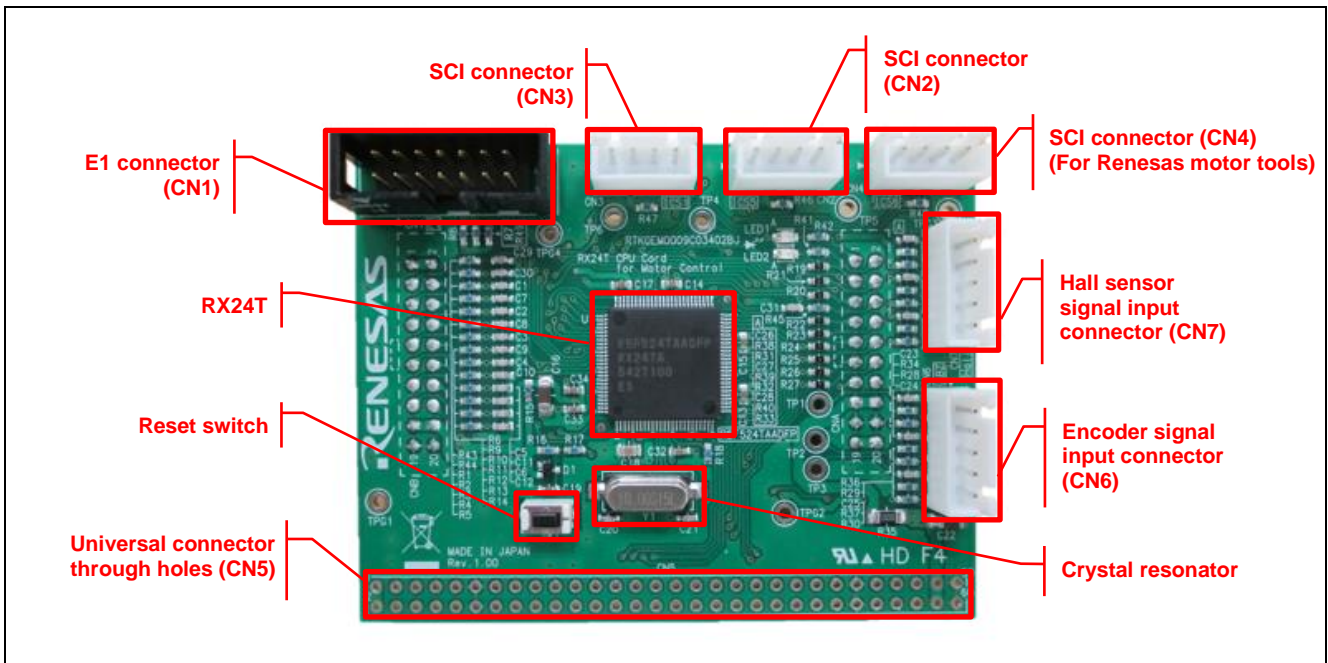

Figure 3.1 RX24T CPU Card Layout (Top view)

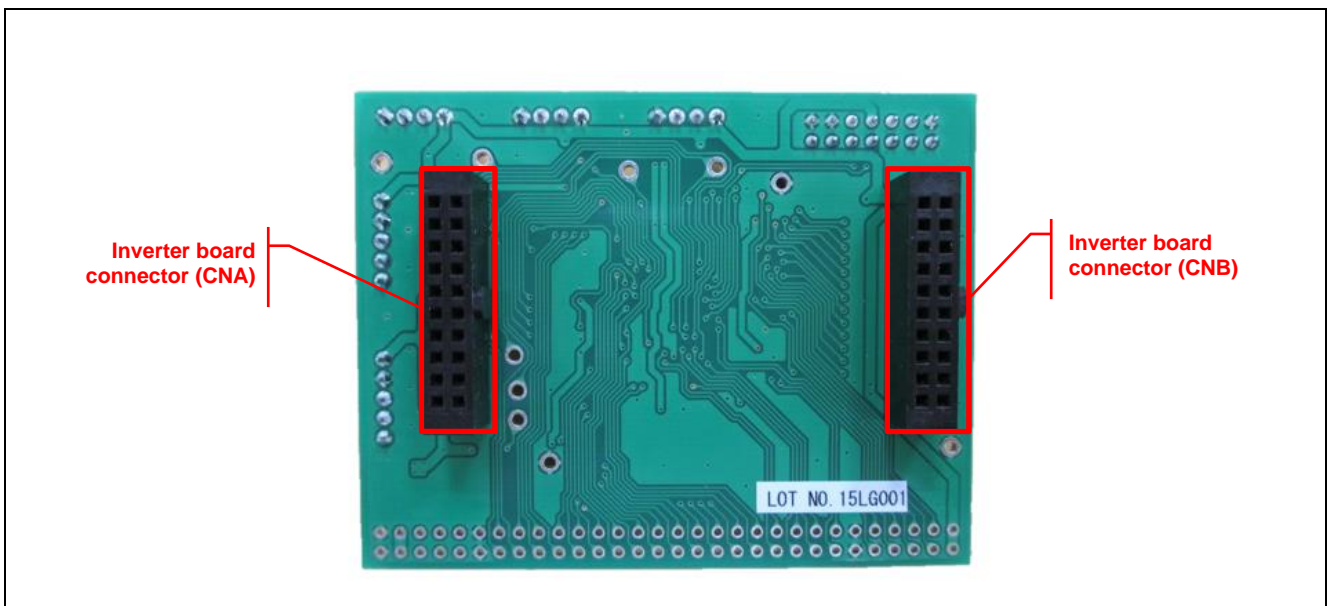

Figure 3.2 RX24T CPU Card Layout (Bottom view)

4. Usage

Before connecting to the INV-BRD, be sure to write the software corresponding to the INV-BRD to this product. The board may be damaged if it is connected to the INV-BRD with the factory default software or with software that is not compatible with the inverter board.

For details on writing software, please refer to 5.2. For the operation of the written software, refer to the application note of each software.

Please refer to the user's manual of each INV-BRD for the connection method with INV-BRD.

5. Functions

5.1 Power Supply

The product does not have a dedicated power supply connector. When connected to the INV-BRD it draws power via the connector. When not connected to the INV-BRD, it can draw power via the E1 connector. The product is not allowed to draw power via the E1 connector when it is connected to the INV-BRD.

5.2 Connecting the Emulator

The E1/E2 Lite debugging emulator from Renesas Electronics is used to write software (program) to the flash memory of the RX24T. Software will be downloaded into the product via E1 or E2 Lite. It is also necessary to make the settings shown in Table 5.1 in the integrated development environment or in the Renesas flash programmer to enable the emulator to supply power to the product. Table 5.2 lists the pin assignments of the E1 connector.

Table 5.1 E1,E2 Lite Power Supply Settings

Connection to INV-BRD	Power Supply Setting
Connected	Power supply not allowed*1
Not connected	5 V or 3.3V power supply

Note 1. When connected to the INV-BRD, the product must draw power from the INV-BRD.

Table 5.2 Pin Assignments of E1 Connector (CN1)

Pin No.	Pin Function	RX24T Connection Pins	Pin No.	Pin Function	RX24T Connection Pins
1	NC	—	2	GND	VSS
3	NC	—	4	NC	—
5	TXD	PD3/TXD1	6	NC	—
7	MD/FINED	MD/FINED	8	VCC	VCC
9	NC	—	10	NC	—
11	RXD	PD5/RXD1	12	GND	VSS
13	RESET	RES#	14	GND	VSS

Note: See a supplement to the E1/E20/E2 emulator, E2 emulator Lite user's manual.

5.3 Connecting the Inverter Board

The product connects to the INV-BRD supplied with the Motor RSSK via the inverter board connectors (CNA and CNB). Table 5.3 and Table 5.4 list the pin assignments of the inverter board connectors.

Table 5.3 Pin Assignments of Inverter Board Connector (CNA)

Pin No.	Pin Function	RX24T Connection Pins	Pin No.	Pin Function	RX24T Connection Pins
1	LED1#	PA2	2	LED2#	PA1
3	LED3#	PD7	4	NC	PB3
5	FO#	P70/POE0#	6	NC	P55
7	WN	P76/MTIOC4D	8	VN	P75/MTIOC4C
9	UN	P74/MTIOC3D	10	WP	P73/MTIOC4B
11	VP	P72/MTIOC4A	12	UP	P71/MTIOC3B
13	SW1#	P80	14	SW2#	P81
15	5V	VCC	16	5V	VCC
17	GND	VSS	18	GND	VSS
19	3.3V	—	20	3.3V	—

Table 5.4 Pin Assignments of Inverter Board Connector (CNB)

Pin No.	Pin Function	RX24T Connection Pins	Pin No.	Pin Function	RX24T Connection Pins
1	AVCC	AVCC	2	AVCC	AVCC
3	NC	P42/AN002	4	NC	P43/AN003
5	IU	P44/AN100	6	IV	P45/AN101
7	IW	P46/AN102	8	VPN	P64/AN204
9	TEMP	P65/AN205	10	VU	P61/AN201
11	VV	P62/AN202	12	VW	P63/AN203
13	VAC	P51/AN207	14	IPFC	P52/AN208
15	VR	P53/AN209	16	RSVIN	P54/AN210
17	VCCIO	VCC	18	VCCIO	VCC
19	GND	VSS	20	GND	VSS

5.4 Connecting the SCI

The product communicates with the SCI via the SCI connectors. There are three SCI connectors: CN2, CN3, and CN4. Table 5.5 lists their pin assignments. Use CN4 when using tools such as waveform display in combination with INV-BRD.

Table 5.5 Pin Assignments of SCI Connectors (CN2, CN3, CN4)

Connector No.	Pin No.	Pin Function	RX24T Connection Pins
CN2 SCI5	1	5V	VCC
	2	RX24T transmit side	PB5/TXD5
	3	RX24T receive side	PB6/RXD5
	4	GND	VSS
CN3 SCI1*1	1	5V	VCC
	2	RX24T transmit side	PD3/TXD1
	3	RX24T receive side	PD5/RXD1
	4	GND	VSS
CN4 SCI6	1	5V	VCC
	2	RX24T transmit side	PB2/TXD6
	3	RX24T receive side	PB1/RXD6
	4	GND	VSS

Note 1. The SCI1 TXD and RXD pins are also used by E1/E2 Lite, so it is not possible to use SCI1 when the product is connected to the E1/E2 Lite.

5.5 Hall Sensor Signal Input

The product is equipped with a Hall sensor signal input connector. The signal input to the product is pulled up to 5 V and passed through an RC filter before being input to the RX24T. Table 5.6 lists the pin assignments of the Hall sensor signal input connector, and Table 5.7 lists connector information.

Table 5.6 Pin Assignments of Hall Sensor Signal Input Connector (CN7)

Pin No.	Pin Function	RX24T Connection Pins
1	5V	VCC
2	GND	VSS
3	HU	P10
4	HV	P11
5	HW	P96

Table 5.7 Hall Sensor Signal Input Connector Information

Part	Product No.	Manufacturer
Connector (CN7)	XHP-5	J.S.T. Mfg. Co. Ltd. (JST)

5.6 Encoder Signal Input

The product is equipped with an encoder signal input connector. This makes it possible to input the encoder signal to the RX24T. The signal input to the product is pulled up to 5 V and passed through an RC filter before being input to the RX24T. Table 5.8 lists the pin assignments of the signal input connector, and Table 5.9 lists connector information.

Table 5.8 Pin Assignments of Encoder Signal Input Connector (CN6)

Pin No.	Pin Function	RX24T Connection Pins
1	5V	VCC
2	GND	VSS
3	A-phase	P33/MTCLKA
4	B-phase	P32/MTCLKB
5	Z-phase	PA5

Table 5.9 Encoder Signal Input Connector Information

Part	Product No.	Manufacturer
Connector (CN6)	XHP-5	J.S.T. Mfg. Co. Ltd. (JST)

5.7 Extension of Unused Pins

To facilitate general use of the product, the unused pins of the RX24T are extended through universal connector through holes in the board. Table 5.10 lists the pin assignments of the universal connector through holes.

Table 5.10 Pin Assignments of Universal Connector Through Holes

Pin No.	RX24T Connection Pins	Pin No.	RX24T Connection Pins
1	AVCC	2	AVCC
3	P60	4	P55
5	P50	6	P47
7	P43	8	P42
9	P41	10	P40
11	VSS	12	VSS
13	PE5	14	P02
15	P00	16	P01
17	PE4	18	PE3
19	PE1	20	PE0
21	PD6	22	PD4
23	PD2	24	PD1
25	PD0	26	PB7
27	PB4	28	PB3
29	PB0	30	PA4
31	PA3	32	PA0
33	P95	34	P94
35	P93	36	P92
37	P91	38	P90
39	P31	40	P30
41	P24	42	P23
43	P22	44	P21
45	P20	46	P82
47	P81	48	P80
49	VSS	50	VSS
51	NC	52	NC
53	NC	54	NC
55	NC	56	NC
57	UVCC	58	UVCC
59	VSS	60	VSS

5.8 Reset Circuit

The product is equipped with a reset circuit for resetting the microcontroller at power-on reset and external reset. To apply an external reset to the microcontroller, press the pushbutton (SW1).

5.9 Crystal Resonator

The microcontroller mounted on the product is connected to a 10 MHz crystal resonator.

5.10 LEDs

Two LEDs are mounted on the product for use in debugging programs and general system applications. Each turns on when the output on the corresponding port is low-level and turns off when the output is high-level. Table 5.11 lists the pin assignments corresponding to the LEDs.

Table 5.11 RX24T CPU Card LED Connection Pin Assignments

Corresponding RX24T Port		LED1	LED2
PA2	High-level output	Off	—
	Low-level output	On	—
PA1	High-level output	—	Off
	Low-level output	—	On

6. Details of RX24T CPU Card

6.1 RX24T Features

1. 32-bit microcontroller with RXv2 CPU core for motor control
2. On-chip 32-bit single-precision floating point unit (FPU)
3. Ability to output three-phase complementary PWM waveforms on two channels
4. Ability to set timer interrupt as A/D trigger
5. Three 12-bit A/D converter units with a total of 22 channels
6. Channel-dedicated sample and hold function
7. On-chip programmable gain amplifier and comparator
8. Timer output stop (Hi-Z) function
9. On-chip independent watchdog timer

6.2 RX24T Pin Assignments

75	76	50	P90/MTIOC7D
74	77	49	P91/MTIOC7C
73	78	48	P92/MTIOC6D
72	79	47	P93/MTIOC7B
71	80	46	P94/MTIOC7A
70	81	45	P95/MTIOC6B
69	82	44	VSS
68	83	43	P96/POE4#/IRQ4
67	84	42	VCC
66	85	41	PA0/MTIOC6C/TMO2/SSLA3
65	86	40	PA1/MTIOC6A/TMO4/SSLA2/ADTRG0#
64	87	39	PA2/MTIOC2B/TMO7/CTS6#/RTS6#/SS6#/SSLA1
63	88	38	PA3/MTIOC2A/TMR17/SSLA0
62	89	37	PA4/MTIOC1B/TMC17/SCK6/RSPCKA/ADTRG0#
61	90	36	PA5/MTIOC1A/TMC13/RXD6/SMISO6/SSCL6/MISOA/IRQ1/ADTRG1#
60	91	35	PB0/MTIOC0D/TMO0/TXD6/SMOSI6/SSDA6/MOSIA/ADTRG2#
59	92	34	PB1/MTIOC0C/TMC10/ADSM1/RXD6/SMISO6/SSCL6/SCL0
58	93	33	PB2/MTIOC0B/TMR10/ADSM0/TXD6/SMOSI6/SSDA6/SDA0
57	94	32	PB3/MTIOC0A/CACREF/SCK6/RSPCKA
56	95	31	VSS
55	96	30	PB4/POE8#/CTS5#/RTS5#/SS5#/IRQ3
54	97	29	VCC
53	98	28	PB5/TXD5/SMOSI5/SSDA5
52	99	27	PB6/RXD5/SMISO5/SSCL5/IRQ5
51	100	26	PB7/SCK5
	1		PE5/IRQ0
	2		P02/MTIOC9D/CTS1#/RTS1#/SS1#/IRQ5/ADST0
	3		VSS
	4		P00/IRQ2/ADST1
	5		VCL
	6		MD/FINED
	7		P01/POE12#/IRQ4/ADST2
	8		PE4/MTCLKC/POE10#/IRQ1
	9		PE3/MTCLKD/POE11#/IRQ2
	10		RES#
	11		XTAL
	12		VSS
	13		EXTAL
	14		VCC
	15		PE2/POE10#/NMI
	16		PE1/MTIOC9D/TMO5/CTS5#/RTS5#/SS5#/SSLA3
	17		PE0/MTIOC9B/TMC11/TMC15/SSLA2
	18		PD7/MTIOC9A/TMR11/TMR15/SSLA1
	19		PD6/MTIOC9C/TMO1/CTS1#/RTS1#/SS1#/SSLA0/IRQ5/ADST0
	20		PD5/TMR10/TMR16/RXD1/SMISO1/SSCL1/IRQ3
	21		PD4/TMC10/TMC16/SCK1/IRQ2
	22		PD3/TMO0/TXD1/SMOSI1/SSDA1
	23		PD2/TMC11/TMO4/SCK5/MOSIA
	24		PD1/TMO2/MISOA
	25		PD0/TMO6/RSPCKA

Figure 6.1 RX24T Pin Assignments (1/2)

	P62/AN202/IRQ6	75		
	P63/AN203/IRQ7	74		
	AVSS2	73		
	VREF	72		
	AVCC2	71		
	P64/AN204	70		
	P65/AN205	69		
	P20/MTCLKB/MTIOC9C/TMR14/IRQ7/ADTRG0#/AN016/CVREFC0	68		
	P21/MTCLKA/MTIOC9A/TMC14/IRQ6/ADTRG1#/AN116/CVREFC1	67		
	P22/MTIC5W/TMR12/TMO4/MISOA/ADTRG2#/COMP2	66		
	P23/MTIC5V/TMO2/CACREF/MOSIA/COMP1	65		
	P24/MTIC5U/TMC12/TMO6/RSPCKA/COMP0	64		
	P30/MTIOC0B/MTCLKD/TMC16/SSLA0/IRQ7/COMP3	63		
	VSS	62		
	P31/MTIOC0A/MTCLKC/TMR16/SSLA1/IRQ6	61		
	VCC	60		
	P32/MTIOC3C/MTCLKB/TMO6/SSLA2	59		
	P33/MTIOC3A/MTCLKA/TMO0/SSLA3	58		
	P70/POE0#/IRQ5	57		
	P71/MTIOC3B	56		
	P72/MTIOC4A	55		
	P73/MTIOC4B	54		
	P74/MTIOC3D	53		
	P75/MTIOC4C	52		
	P76/MTIOC4D	51		
	P61/AN201/IRQ5	76		50
	P60/AN200/IRQ4	77		49
	P55/AN211/IRQ3	78		48
	P54/AN210/IRQ2	79		47
	P53/AN209/IRQ1	80		46
	P52/AN208/IRQ0	81		45
	P51/AN207	82		44
	P50/AN206	83		43
	P47/AN103	84		42
P46/AN102/CMPC12/CMPC13/CMPC30/CMPC31	85			41
P45/AN101/CMPC02/CMPC03/CMPC20/CMPC21	86			40
P44/AN100/CMPC10/CMPC11/CMPC32/CMPC33	87			39
P43/AN003	88			38
P42/AN002	89			37
P41/AN001	90			36
P40/AN000/CMPC00/CMPC01/CMPC22/CMPC23	91			35
AVCC1	92			34
AVCC0	93			33
AVSS0	94			32
AVSS1	95			31
P82/MTIC5U/TMO4/SCK6	96			30
P81/MTIC5V/TMC14/TXD6/SMOSI6/SSDA6	97			29
P80/MTIC5W/TMR14/RXD6/SMISO6/SSCL6	98			28
P11/MTIOC3A/MTCLKC/TMO3/IRQ1	99			27
P10/MTIOC9B/MTCLKD/TMR13/POE12#/CTS6#/RTS6#/SS6#/IRQ0	100			26

Figure 6.2 RX24T Pin Assignments (2/2)

6.3 List of RX24T Pin Functions

Table 6.1 List of RX24T Pin Functions

Pin No.	RX24T Pin Functions	CPU Card Connection	INV-BRD Connection
1	PE5/IRQ0	CN5-13 pin	Not connected
2	P02/MTIOC9D/CTS1#/RTS1#/SS1#/IRQ5/ADST0	CN5-14 pin	Not connected
3	VSS	GND	GND
4	P00/IRQ2/ADST1	CN5-15 pin	Not connected
5	VCL	Capacitor connection	Not connected
6	MD/FINED	CN1-7pin	Not connected
7	P01/POE12#/IRQ4/ADST2	CN5-16 pin	Not connected
8	PE4/MTCLKC/POE10#/IRQ1	CN5-17 pin	Not connected
9	PE3/MTCLKD/POE11#/IRQ2	CN5-18 pin	Not connected
10	RES#	reset	Not connected
11	XTAL	Crystal resonator (10MHz)	Not connected
12	VSS	GND	GND
13	EXTAL	Crystal resonator (10MHz)	Not connected
14	VCC	VCC	VCC
15	PE2/POE10#/NMI	Pull-down	Not connected
16	PE1/MTIOC9D/TMO5/CTS5#/RTS5#/SS5#/SSLA3	CN5-19 pin	Not connected
17	PE0/MTIOC9B/TMCI1/TMCI5/SSLA2	CN5-20 pin	Not connected
18	PD7/MTIOC9A/TMRI1/TMRI5/SSLA1	CNA-3 pin	LED3 cathode
19	PD6/MTIOC9C/TMO1/CTS1#/RTS1#/SS1#/SSLA0/IRQ5/ADST0	CN5-21 pin	Not connected
20	PD5/TMRI0/TMRI6/RXD1/SMISO1/SSCL1/IRQ3	CN1-11 pin/ CN3-3 pin	Not connected
21	PD4/TMCI0/TMCI6/SCK1/IRQ2	CN5-22 pin	Not connected
22	PD3/TMO0/TXD1/SMOSI1/SSDA1	CN1-5 pin/CN3-2 pin	Not connected
23	PD2/TMCI1/TMO4/SCK5/MOSIA	CN5-23 pin	Not connected
24	PD1/TMO2/MISOA	CN5-24 pin	Not connected
25	PD0/TMO6/RSPCKA	CN5-25 pin	Not connected
26	PB7/SCK5	CN5-26 pin	Not connected
27	PB6/RXD5/SMISO5/SSCL5/IRQ5	CN2-3 pin	Not connected
28	PB5/TXD5/SMOSI5/SSDA5	CN2-2 pin	Not connected
29	VCC	VCC	VCC
30	PB4/POE8#/CTS5#/RTS5#/SS5#/IRQ3	CN5-27 pin	Not connected
31	VSS	GND	GND
32	PB3/MTIOC0A/CACREF/SCK6/RSPCKA	CN5-28 pin	Not connected
33	PB2/MTIOC0B/TMRI0/ADSM0/TXD6/SMOSI6/SSDA6/SDA0	CN4-2 pin	Not connected
34	PB1/MTIOC0C/TMCI0/ADSM1/RXD6/SMISO6/SSCL6/SCL0	CN4-3 pin	Not connected
35	PB0/MTIOC0D/TMO0/TXD6/SMOSI6/SSDA6/MOSIA/ADTRG2#	CN5-29 pin	Not connected
36	PA5/MTIOC1A/TMCI3/RXD6/SMISO6/SSCL6/MISOA/IRQ1/ADTRG1#	CN6-5 pin	Not connected

Pin No.	RX24T Pin Functions	CPU Card Connection	INV-BRD Connection
37	PA4/MTIOC1B/TMCI7/SCK6/ RSPCKA/ADTRG0#	CN5-30 pin	Not connected
38	PA3/MTIOC2A/TMRI7/SSLA0	CN5-31 pin	Not connected
39	PA2/MTIOC2B/TMO7/CTS6#/ RTS6#/SS6#/SSLA1	LED1 cathode/ CNA-1 pin	LED1 cathode
40	PA1/MTIOC6A/TMO4/SSLA2/ADTRG0#	LED2 cathode/ CNA-2 pin	LED2 cathode
41	PA0/MTIOC6C/TMO2/SSLA3	CN5-32 pin	Not connected
42	VCC	VCC	VCC
43	P96/POE4#/IRQ4	CN7-5 pin	Not connected
44	VSS	GND	GND
45	P95/MTIOC6B	CN5-33 pin	Not connected
46	P94/MTIOC7A	CN5-34 pin	Not connected
47	P93/MTIOC7B	CN5-35 pin	Not connected
48	P92/MTIOC6D	CN5-36 pin	Not connected
49	P91/MTIOC7C	CN5-37 pin	Not connected
50	P90/MTIOC7D	CN5-38 pin	Not connected
51	P76/MTIOC4D	CNA-7 pin	W-phase PWM output
52	P75/MTIOC4C	CNA-8 pin	V-phase PWM output
53	P74/MTIOC3D	CNA-9 pin	U-phase PWM output
54	P73/MTIOC4B	CNA-10 pin	W+phase PWM output
55	P72/MTIOC4A	CNA-11 pin	V+phase PWM output
56	P71/MTIOC3B	CNA-12 pin	U+phase PWM output
57	P70/POE0#/IRQ5	CNA-5 pin	Overcurrent detection
58	P33/MTIOC3A/MTCLKA/TMO0/SSLA3	CN6-3 pin	Not connected
59	P32/MTIOC3C/MTCLKB/TMO6/SSLA2	CN6-4 pin	Not connected
60	VCC	VCC	VCC
61	P31/MTIOC0A/MTCLKC/TMRI6/ SSLA1/IRQ6	CN5-39 pin	Not connected
62	VSS	GND	GND
63	P30/MTIOC0B/MTCLKD/TMCI6/ SSLA0/IRQ7/COMP3	CN5-40 pin	Not connected
64	P24/MTIC5U/TMCI2/TMO6/ RSPCKA/COMP0	CN5-41 pin	Not connected
65	P23/MTIC5V/TMO2/CACREF/ MOSIA/COMP1	CN5-42 pin	Not connected
66	P22/MTIC5W/TMRI2/TMO4/ MISOA/ADTRG2#/COMP2	CN5-43 pin	Not connected
67	P21/MTCLKA/MTIOC9A/TMCI4/IRQ6/ ADTRG1#/AN116/CVREFC1	CN5-44 pin	Not connected
68	P20/MTCLKB/MTIOC9C/TMRI4/IRQ7/ ADTRG0#/AN016/CVREFC0	CN5-45 pin	Not connected
69	P65/AN205	CNB-9 pin	External A/D input
70	P64/AN204	CNB-8 pin	Bus line voltage detection
71	AVCC2	AVCC	AVCC
72	VREF	AVCC	AVCC
73	AVSS2	GND	GND

Pin No.	RX24T Pin Functions	CPU Card Connection	INV-BRD Connection
74	P63/AN203/IRQ7	CNB-12 pin	W-phase voltage detection
75	P62/AN202/IRQ6	CNB-11 pin	V-phase voltage detection
76	P61/AN201/IRQ5	CNB-10 pin	U-phase voltage detection
77	P60/AN200/IRQ4	CN5-3 pin	Not connected
78	P55/AN211/IRQ3	CNA-6 pin/ CN5-4 pin	Not connected
79	P54/AN210/IRQ2	CNB-16 pin	Not connected
80	P53/AN209/IRQ1	CNB-15 pin	VR/switch voltage detection
81	P52/AN208/IRQ0	CNB-14 pin	Not connected
82	P51/AN207	CNB-13 pin	Not connected
83	P50/AN206	CN5-5 pin	Not connected
84	P47/AN103	CN5-6 pin	Not connected
85	P46/AN102/CMPC12/CMPC13/CMPC30/CMPC31	CNB-7 pin	W-phase current detection
86	P45/AN101/CMPC02/CMPC03/CMPC20/CMPC21	CNB-6 pin	V-phase current detection
87	P44/AN100/CMPC10/CMPC11/CMPC32/CMPC33	CNB-5 pin	U-phase current detection
88	P43/AN003	CN5-7 pin	Not connected
89	P42/AN002	CN5-8 pin	Not connected
90	P41/AN001	CN5-9 pin	Not connected
91	P40/AN000/CMPC00/CMPC01/CMPC22/CMPC23	CN5-10 pin	Not connected
92	AVCC1	AVCC	AVCC
93	AVCC0	AVCC	AVCC
94	AVSS0	GND	GND
95	AVSS1	GND	GND
96	P82/MTIC5U/TMO4/SCK6	CN5-46 pin	Not connected
97	P81/MTIC5V/TMCI4/TXD6/SMOSI6/SSDA6	CNA-14 pin/ CN5-47 pin	Toggle switch (SW2)
98	P80/MTIC5W/TMRI4/RXD6/SMISO6/SSCL6	CNA-13 pin/ CN5-48 pin	Toggle switch (SW1)
99	P11/MTIOC3A/MTCLKC/TMO3/IRQ1	CN7-4 pin	Not connected
100	P10/MTIOC9B/MTCLKD/TMRI3/POE12#/ CTS6#/RTS6#/SS6#/IRQ0	CN7-3 pin	Not connected

7. Caution Items

Caution items related to use of the product are as follows.

The product includes some unused pins that have not been processed. For information on accurate pin processing, refer to the hardware manual of the microcontroller.

Website and Support

Renesas Electronics Website

<http://www.renesas.com/>

Inquiries

<http://www.renesas.com/contact/>

All trademarks and registered trademarks are the property of their respective owners.

Revision History

Rev.	Date	Description	
		Page	Summary
1.00	Mar. 31, 2016	—	First edition issued
1.10	Apr. 5, 2017	3	Add the item about cautions (Static Electricity)
		8	Add the information about CE Certification
1.20	Feb. 21, 2019	14	Correct Table 6.4
1.30	Feb. 21, 2022		Revised the description for the compatible inverter board Revised Section 4 (Usage)