

NOTES:

1. ALL DIMENSIONS AND TOLERANCES ARE PER ASME Y14.5M-1994.
2. ALL DIMENSIONS ARE IN MILLIMETERS.

DATE CREATED		REVISIONS		AUTHOR
11/15/16	00	INITIAL RELEASE		JH
12/14/17	01	ADD PIN 1 INDICATOR		JH
NOTE: REFER TO DCP FOR OFFICIAL RELEASE DATE				

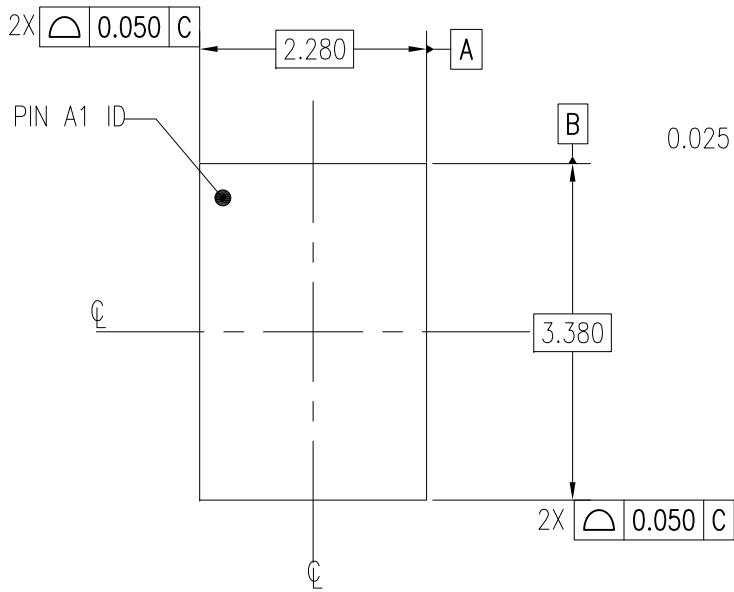

TOP VIEW

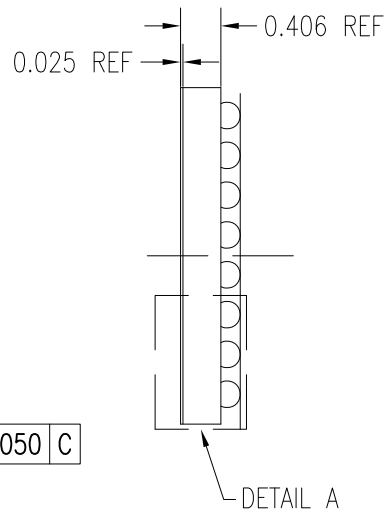

DETAIL A

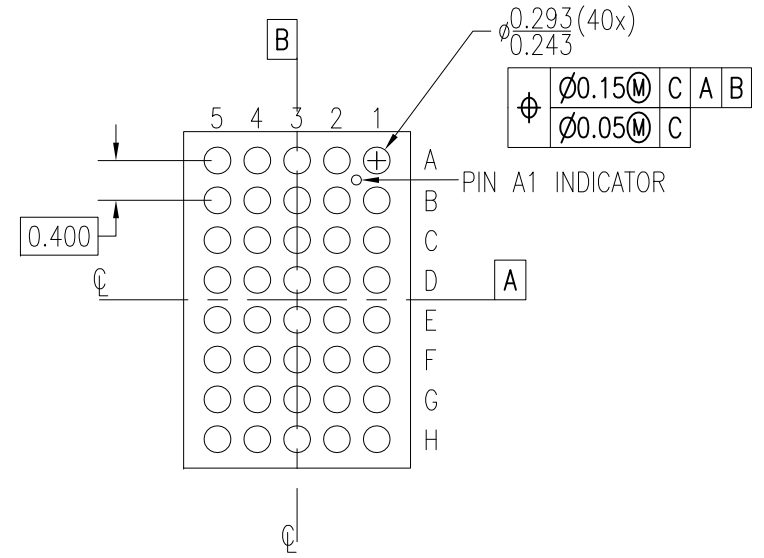

BOTTOM VIEW

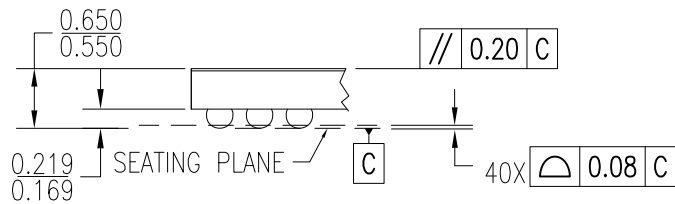

DETAIL A
(ROTATED 90 DEG CW)

TOLERANCES UNLESS SPECIFIED DECIMAL ANGULAR XX± 0.05 ± XXX± 0.012 ± XXXX±		6024 SILVER CREEK VALLEY ROAD, SAN JOSE, CA 95138 PHONE: (408) 284-8200 FAX: (408) 284-3572	
		www.IDT.com	
TITLE AZG40 Package Outline Drawing 2.280 x 3.380 x 0.60 mm Body 0.4mm Pitch DSBGA			
SIZE C	DRAWING No. PSC-4673	REV 01	
DO NOT SCALE DRAWING			SHEET 1 OF 2

DATE CREATED	REVISIONS		
	REV	DESCRIPTION	AUTHOR
11/15/16	00	INITIAL RELEASE	JH
12/14/17	01	ADD PIN 1 INDICATOR	JH

NOTE: REFER TO DCP FOR OFFICIAL RELEASE DATE

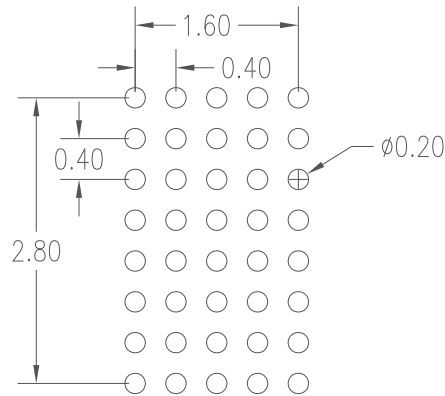

RECOMMENDED LAND PATTERN DIMENSION

NOTE:

1. ALL DIMENSIONS ARE IN MM, ANGLES IN DEGREES.
2. TOP DOWN VIEW, AS VIEW ON PCB.
3. NSMD LAND PATTERN ASSUMED.
4. LAND PATTERN RECOMMENDATION AS PER IPC-7351
GENERIC REQUIREMENT FOR SURFACE MOUNT DESIGN AND LAND PATTERN.

TOLERANCES UNLESS SPECIFIED DECIMAL ANGULAR XX± 0.05 ± XXX± 0.012 XXXX±		 IDT™ www.IDT.com 6024 SILVER CREEK VALLEY ROAD. SAN JOSE, CA 95138 PHONE: (408) 284-8200 FAX: (408) 284-3572
TITLE AZG40 Package Outline Drawing 2.280 x 3.380 x 0.60 mm Body 0.4mm Pitch DSBGA		
SIZE	DRAWING No.	REV
C	PSC-4673	01
DO NOT SCALE DRAWING		SHEET 2 OF 2