

TOP VIEW

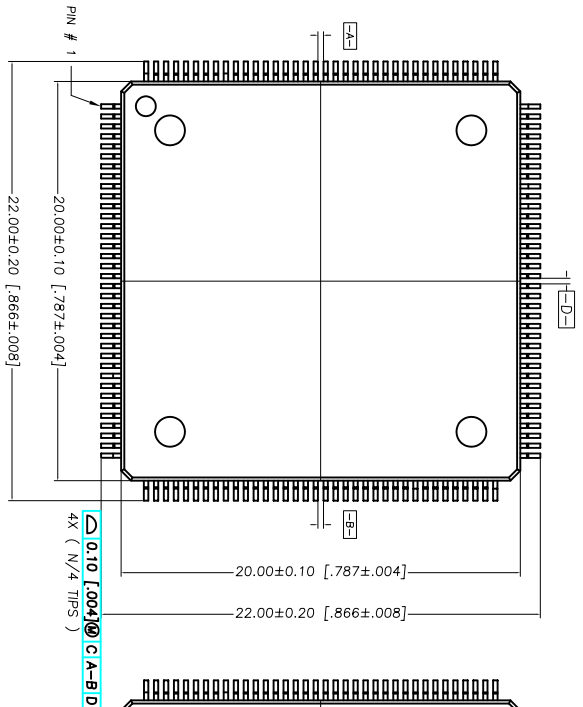

BOTTOM VIEW

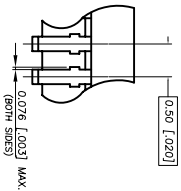
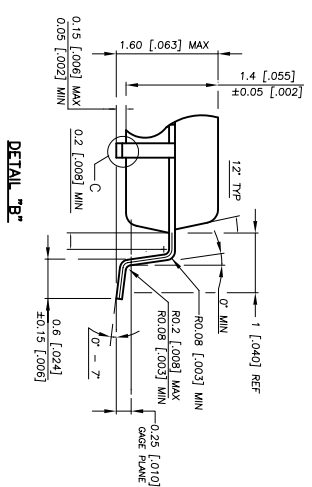
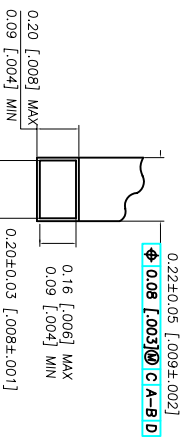
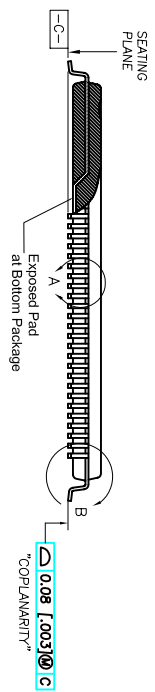
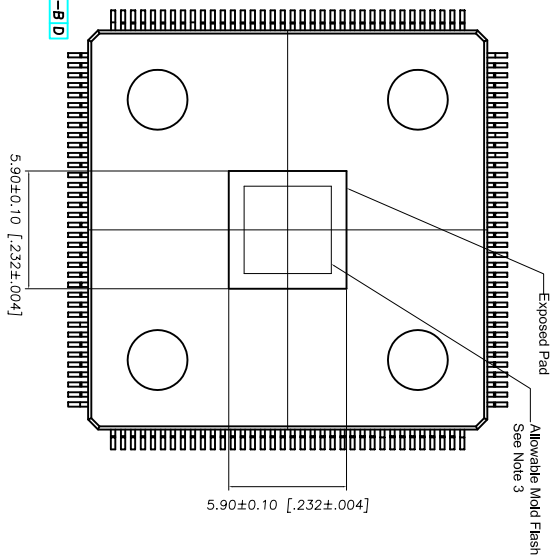

- NOTES :
1. BODY SIZE DIMENSIONS DO NOT INCLUDE MOLD PROTRUSION. ALLOWABLE PROTRUSION IS 0.25 [0.010] PER SIDE.
 2. THE TOP PACKAGE BODY SIZE MAY BE SMALLER THAN THE BOTTOM BODY SIZE BY AS MUCH AS 0.15 [0.06].
 3. MOLD FLASH MAX. IS 30 MILS FROM E-PAD LINE
 4. DRAWING CONFORMS TO JEDEC MS-026 REV. D.
 5. CONTROLLING DIMENSION IN MM.

REVISIONS			
REV	DESCRIPTION	DATE	APPROVED
00	INITIAL RELEASE	3/17/12	DP
01	COMBINED PAD & LAND PATTERN	5/30/13	KS

TOLERANCES UNLESS SPECIFIED		6024 SILVER CREEK	
DECIMAL	ANGULAR	VALLEY ROAD, SAN JOSE, CA 95138	
±	±	PHONE: (408) 294-8200	
XXXX±		FAX: (408) 294-3572	
APPROVALS	DATE	WWW.IDT.COM	
DRAWN <i>RG</i>	03/07/12		
CHECKED		TITLE EK/EG144 E-PAD LQFP (20X20X1.4MM) PACKAGE OUTLINE	
SIZE	DRAWING No.	REV	
C	PSC-4188	01	
DO NOT SCALE DRAWING			SHEET 1 OF 2

REVISIONS			
REV	DESCRIPTION	DATE	APPROVED
00	INITIAL RELEASE	3/17/12	DP
01	COMBINED POD & LAND PATTERN	5/30/13	KS

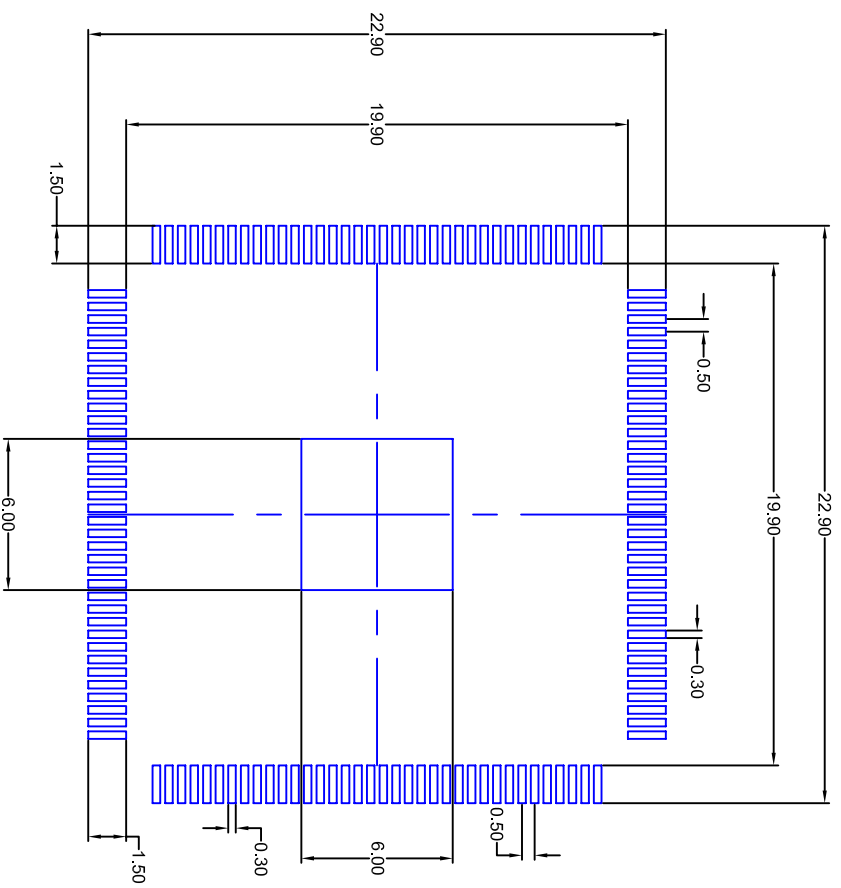

RECOMMENDED LAND PATTERN DIMENSION

NOTE:

- 1) ALL dimensions are in mm, Angles in degrees.
- 2) Top down view, as view on PCB.
- 3) NSMD Land Pattern Assumed
- 4) Land Pattern Recommendation as per IPC-7351B generic requirement for surface mount design and Land Pattern.

TOLERANCES UNLESS SPECIFIED DECIMAL ± ANGULAR ±		 6024 SILVER CREEK VALLEY ROAD, SAN JOSE, CA 95138 PHONE: (408) 294-8200 FAX: (408) 294-3572	
APPROVALS	DATE	TITLE	WWW.IDT.COM
DRAWN	03/07/12	EY/EKG144 E-PAQ LQFP (20X20X1.4MM)	
CHECKED		PACKAGE OUTLINE	
SIZE	C	DRAWING No.	PSC-4188
DO NOT SCALE DRAWING		REV	01
		SHEET	2 OF 2