

456-PIN PLASTIC BGA (35x35)

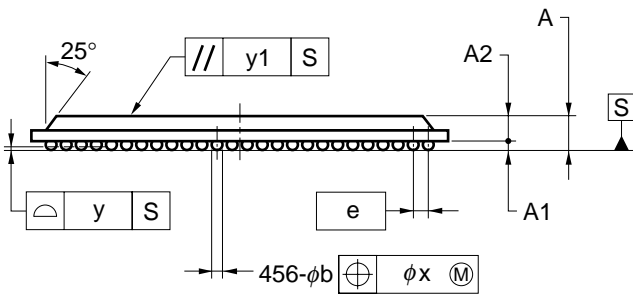
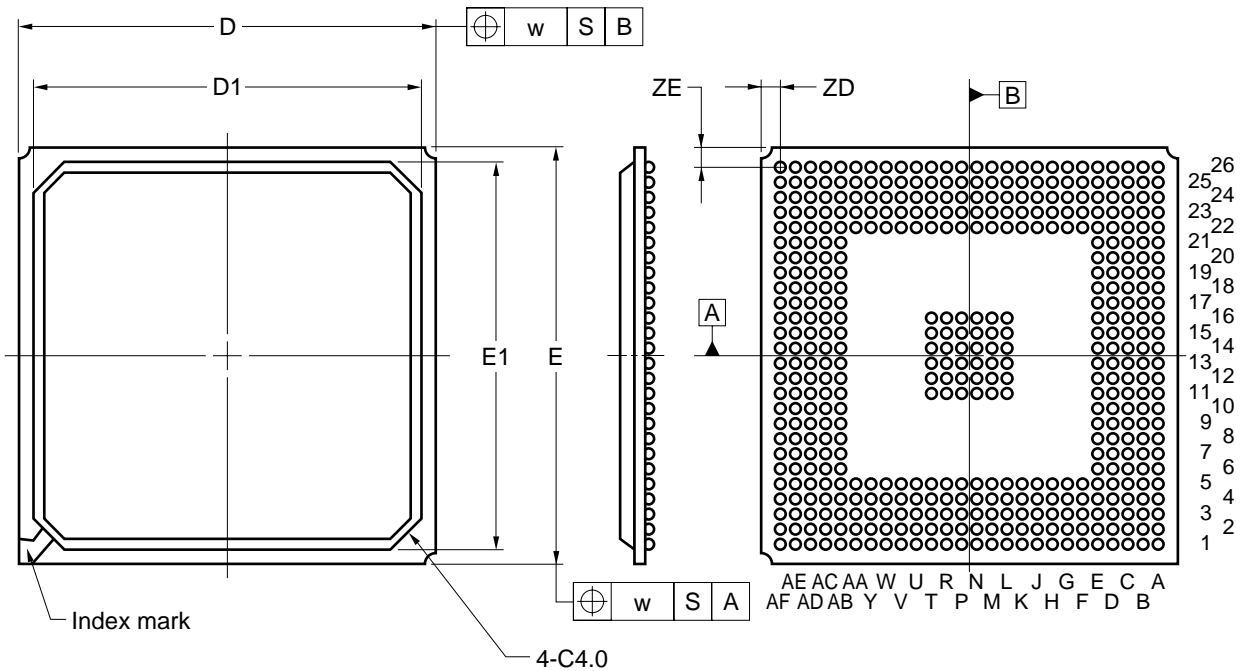

ITEM	MILLIMETERS
D	35.00±0.20
D1	32.0
E	35.00±0.20
E1	32.0
w	0.30
e	1.27
A	2.33±0.25
A1	0.60±0.10
A2	1.73
b	0.75±0.15
x	0.15
y	0.15
y1	0.35
ZD	1.625
ZE	1.625