

Application Note

Test Jig Tool for DA14531 Smartbond TINY™ Module

AN-B-083

Abstract

This document describes the connections and usage of a test jig, which can be used for programming Flash and OTP of the DA14531 Smartbond Tiny module.

**Test Jig Tool for DA14531 Smartbond TINY™
Module**
Contents

Abstract	1
Contents	2
Figures.....	2
Tables	2
1 Terms and Definitions.....	3
2 References	3
3 Introduction.....	4
4 Setup of the hardware.....	5
5 Connecting the test jig to the DevKit -Pro	6
6 Connecting the test jig to DA14531 USB Dongle	7
7 Connecting the test jig to the Production Line Tool (PLT)	8
8 How to operate the test jig	9
9 Ordering information	9
Appendix A Interconnections of Pogo-pins to Sub D15	10
Revision History	11

Figures

Figure 1: Photo of the DA14531 Test Jig	4
Figure 2: Connections from DA14531 Module to SUB D15	5
Figure 3: DA14531 Module Connections and Top View of DA14531 Module	5
Figure 4: Connections between DevKit -Pro and SUB D15	6
Figure 5: Top View of the DA14531 USB Dongle with Switch-settings	7
Figure 6: Connections between DA14531 USB Dongle and SUB D15	7
Figure 7: Connection between PLT (DUT1) and SUB D15 are Shown in Table.....	8
Figure 8: Opened Jig - Empty Module Holder - Module in Holder - Closed Jig	9
Figure 9: [Left] Connections of Module (Top View) - [Right] Module Holder With and Without Module	10
Figure 10: [Left and Middle] Backside of Pogo-pins - using Heat Shrink Tubing on all Pogo-pins [Right] Backside of SUB D15 - also Heat Shrink Tubing used.....	10

Tables

Table 1: Interconnection Pogo-pins and SUB D15	10
--	----

Test Jig Tool for DA14531 Smartbond TINY™ Module

1 Terms and Definitions

BLE	Bluetooth® Low Energy
IDE	Integrated Development Environment
PLT	Production Line Tool
SOC	System On Chip
SWD	Serial Wire Debug interface
UART	Universal Asynchronous Receiver Transmitter
USB	Universal Serial Bus

2 References

- [1] DA14531 Datasheet, Dialog Semiconductor
- [2] UM-B-114, User Manual DA14531 Development Kit PRO, Dialog Semiconductor
- [3] UM-B-125, User Manual DA14531 USB Development Kit Hardware, Dialog Semiconductor
- [4] DA14531, Bluetooth 5.1 System-On-Chip product page, Dialog Semiconductor
- [5] DA14531 Tiny Module product page, Dialog Semiconductor
- [6] Production Line Tool product page, Dialog Semiconductor
- [7] UM-B-083, User Manual SmartSnippets Toolbox, Dialog Semiconductor
- [8] UM-B-138, User Manual, FlashProgrammer, Dialog Semiconductor

Test Jig Tool for DA14531 Smartbond TINY™ Module

3 Introduction

The DA14531 SmartBond TINY™ Module [5], based on the world's smallest and lowest power Bluetooth 5.1 System-on-Chip, brings the DA14531 SoC [4] advantages to an integrated module. It just requires a power supply and a printed circuit board to build a Bluetooth application.

This document explains the usage of a test fixture, also called the test jig for the DA14531 TINY Module. The test jig can be used for programming and testing small quantities of the module before mounting them on the PCB. With the test jig connected to an interface board the DA14531 Module can be loaded with firmware using the Dialog programming tools.

The document describes how to connect the test jig to dialog interface boards:

- Development Kit -Pro [2]
- DA14531 USB-Dongle [3]
- Production Line Tool (PLT) [6]

The jig can be used for loading firmware (FW) into SRAM, SPI flash-memory or OTP-memory. See [Figure 1](#).



Figure 1: Photo of the DA14531 Test Jig

Test Jig Tool for DA14531 Smartbond TINY™ Module

4 Setup of the hardware

The jig is equipped with 15 pogo-pins. These pogo-pins are connected to a 15-pins SUB D connector which is mounted on the backside of the jig. In Figure 2, the pins of this male connector are shown. Through a female connector the pins can be connected to an interface board.

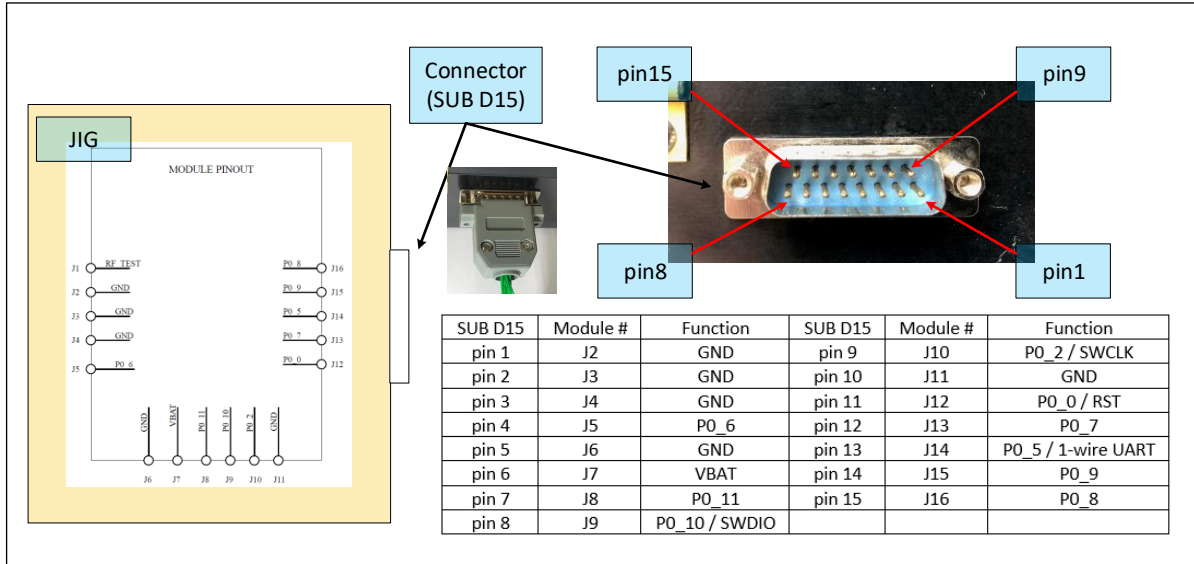

Figure 2: Connections from DA14531 Module to SUB D15

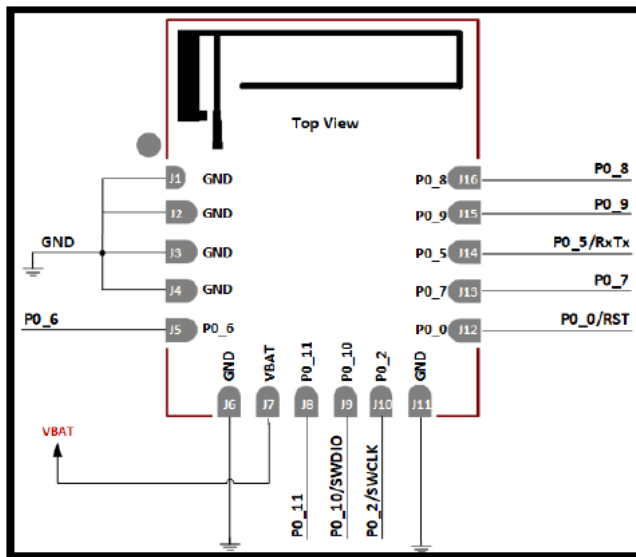

Figure 3: DA14531 Module Connections and Top View of DA14531 Module

Test Jig Tool for DA14531 Smartbond TINY™ Module

5 Connecting the test jig to the DevKit -Pro

The connections between the test jig and the Dialog Devkit Pro are described in Figure 4. Using this set-up there are two different methods to download software to the DA14531 Module:

- Serial Wire Debug (SWD): This interface supports:
 - Downloading firmware to SRAM from Keil IDE
 - Programming Firmware into Flash from the FlashProgrammer tool
 - Programming/Downloading Firmware and settings into Flash, OTP, SRAM using SmartSnippets Toolbox.
- Single-Wire UART: This interface supports:
 - Programming/Downloading Firmware and settings into Flash, OTP, SRAM using SmartSnippets Toolbox.

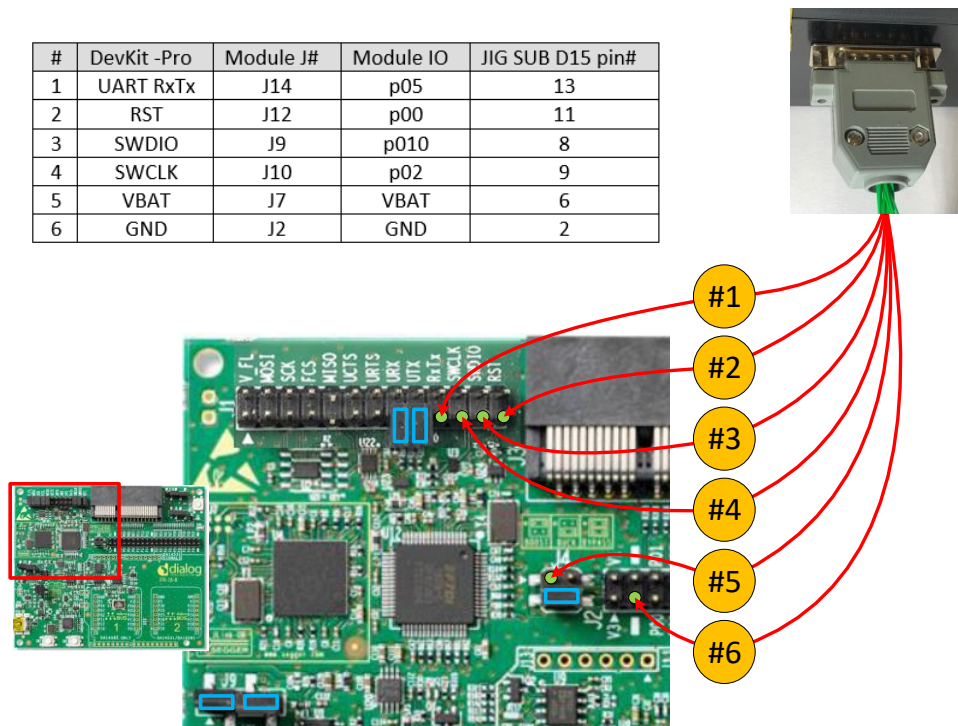

Figure 4: Connections between DevKit -Pro and SUB D15

Connect the USB-cable between the DevKit -Pro and PC. Start one of the SW tools as indicated earlier. For usage of the tools refer to the available user manuals [7], [8]

Test Jig Tool for DA14531 Smartbond TINY™ Module

6 Connecting the test jig to DA14531 USB Dongle

The DA14531 USB Dongle can be used for connecting the signals as described in Figure 6. Because this board has the DA14531 IC soldered on the PCB and connected directly the SWD and UART lines, it must be removed before using this method. Removing the product can be done by using *hot air*. Do not heat the rest of the components, they might get loose, resulting in general failure of the board.

Configure the switches as indicated in Figure 5.

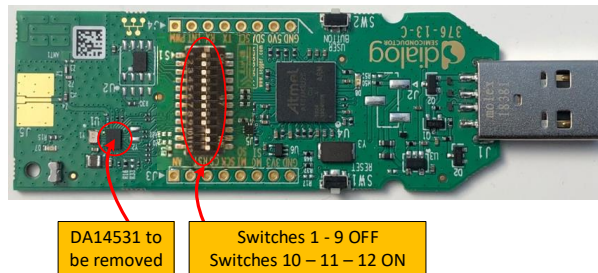

Figure 5: Top View of the DA14531 USB Dongle with Switch-settings

Using this set-up there are two different methods to download software to the DA14531 Module:

- Serial Wire Debug (SWD), this interface supports:
 - Downloading firmware to SRAM from Keil IDE
 - Programming Firmware into Flash from the FlashProgrammer tool
 - Programming/Downloading Firmware and settings into Flash, OTP, SRAM using SmartSnippets Toolbox.
- Single-Wire UART, this interface supports:
 - Programming/Downloading Firmware and settings into Flash, OTP, SRAM using SmartSnippets Toolbox.

Connect the USB-Devkit to a PC (an extension cable makes this easier) and start one of the SW tools as indicated earlier. For usage of the tools refer to the available user manuals [7], [8].

#	531 Dongle	Module J#	Module IO	JIG SUB D15 pin#
1	SWDIO p010	J9	p010	8
2	VBAT	J7	VBAT	6
3	GND	J2	GND	2
4	RST p00	J12	p00	11
5	SWCLK p02	J10	p02	9
6	UART p05	J14	p05	13

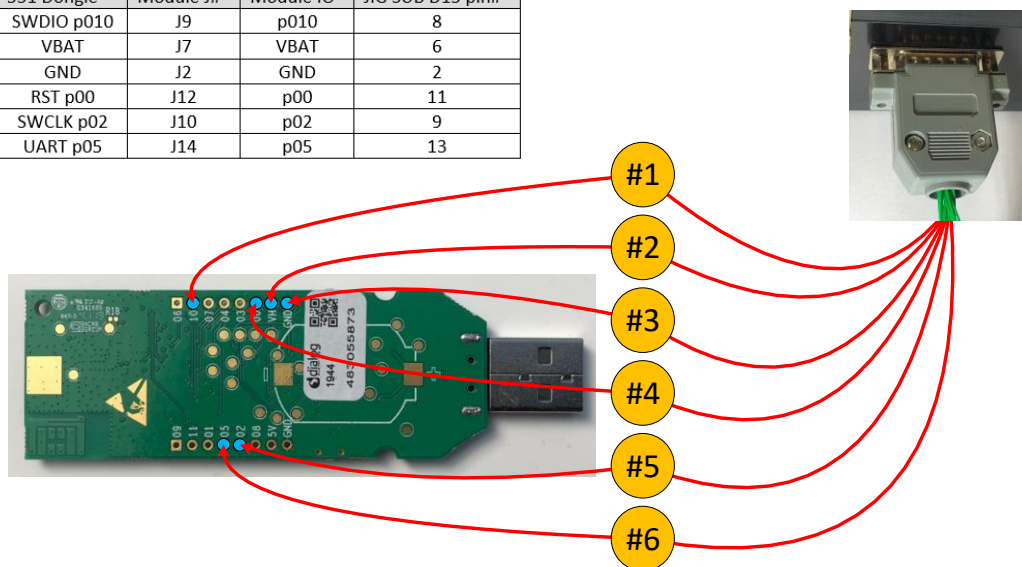

Figure 6: Connections between DA14531 USB Dongle and SUB D15

Test Jig Tool for DA14531 Smartbond TINY™ Module

7 Connecting the test jig to the Production Line Tool (PLT)

The Dialog Production Line Tool hardware allows for programming and testing of up to 16 devices in parallel in a production environment. The method below describes how to connect the test jig with a single device to the PLT hardware. The connections as described in Figure 7 can be used for programming of Firmware and settings into OTP and Flash.

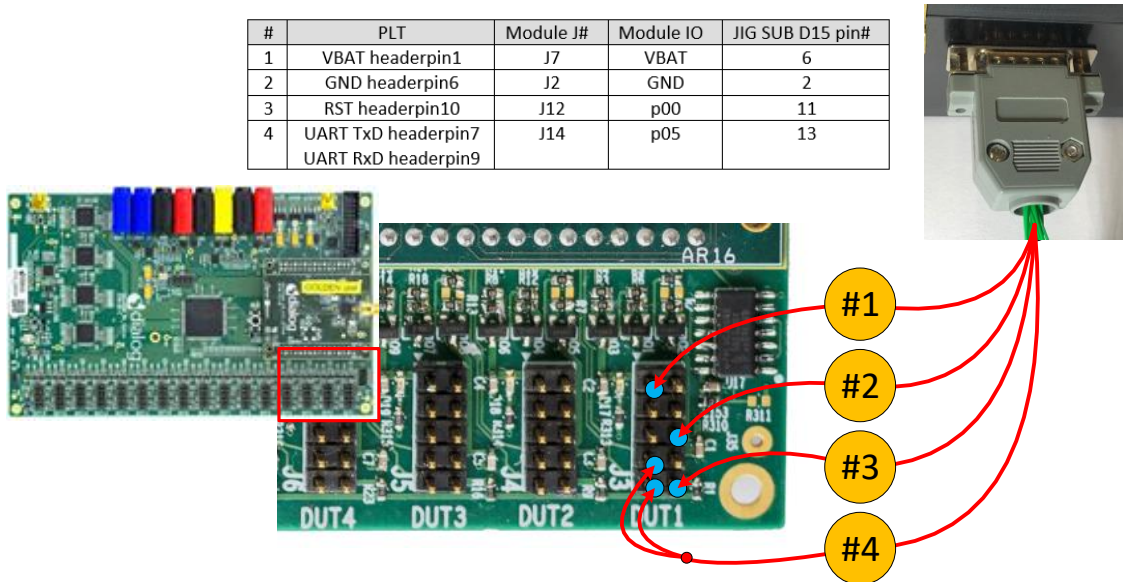

Figure 7: Connection between PLT (DUT1) and SUB D15 are Shown in Table

The single-wire UART cable from the test jig is connected to both the UART-Rx and UART-Tx connection on the PLT. The Reset line (RST) is optional and the SWD is not used by the PLT.

**Test Jig Tool for DA14531 Smartbond TINY™
Module**
8 How to operate the test jig

1. Create the connections as described in [5], [6] and [7].
2. Open the jig by moving the lever back-wards (Figure 8).
3. Take a used Module out of jig holder.
4. Put the new module in the jig holder.
5. Close the JIG. This connects the pogo pins to the module pads.
6. Run the software to program/download firmware.
7. Go to #2 to program the next device.



Figure 8: Opened Jig - Empty Module Holder - Module in Holder - Closed Jig

9 Ordering information

The test jig for the DA14531 Tiny module is available at the online store of Praxis-RF:
<http://www.praxisrf.com/~shop/programming--debug-accessories/da14550-ble-module-programming-jig/427794/>

Test Jig Tool for DA14531 Smartbond TINY™ Module

Appendix A Interconnections of Pogo-pins to Sub D15

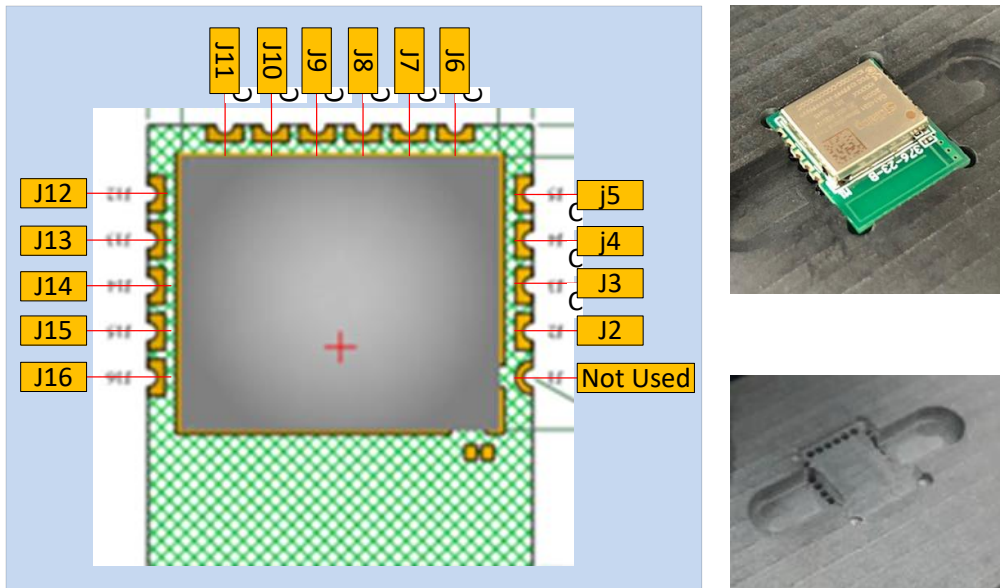

Figure 9: [Left] Connections of Module (Top View) - [Right] Module Holder With and Without Module

Table 1: Interconnection Pogo-pins and SUB D15

Module connections	SUB D15 connections	Module connections	SUB D15 connections
J1	not connected	J9	pin 8
J2	pin 1	J10	pin 9
J3	pin 2	J11	pin 10
J4	pin 3	J12	pin 11
J5	pin 4	J13	pin 12
J6	pin 5	J14	pin 13
J7	pin 6	J15	pin 14
J8	pin 7	J16	pin 15

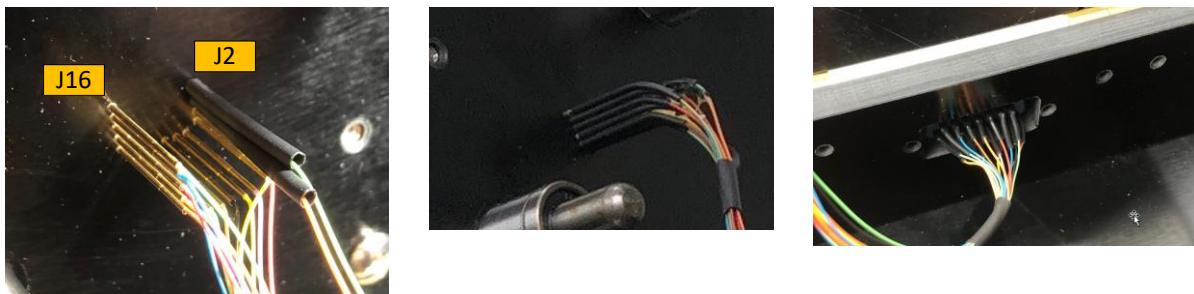

Figure 10: [Left and Middle] Backside of Pogo-pins - using Heat Shrink Tubing on all Pogo-pins
[Right] Backside of SUB D15 - also Heat Shrink Tubing used

**Test Jig Tool for DA14531 Smartbond TINY™
Module****Revision History**

Revision	Date	Description
1.0	07-May-2020	Initial version.
1.1	16-June-2020	Added new section with ordering information.
1.2	25-Jan-2021	Updated logo, disclaimer, copyright.

Test Jig Tool for DA14531 Smartbond TINY™ Module

Status Definitions

Status	Definition
DRAFT	The content of this document is under review and subject to formal approval, which may result in modifications or additions.
APPROVED or unmarked	The content of this document has been approved for publication.

RoHS Compliance

Dialog Semiconductor's suppliers certify that its products are in compliance with the requirements of Directive 2011/65/EU of the European Parliament on the restriction of the use of certain hazardous substances in electrical and electronic equipment. RoHS certificates from our suppliers are available on request.