

SMART METER SOLUTIONS

Catalog



1NG64939850296502

09265 kWh

CL200 240V 3W TYPE C1SR 60Hz TA 30A 1.0 Kh

0006593 16502B01D4

WATTHOUR METER

BIG IDEAS
FOR EVERY SPACE

A NEW STEP TOWARD IMPROVED ENERGY EFFICIENCY

Smart meters enable an advance toward a next-generation ecology in which electric power, gas, and water meters are linked via networks. Renesas' metrology and communication technology with ultra-low-power technology raise smart meters to a new level.



CONTENT

Role Of Smart Meters and Market Trends	02
Smart Meter Solutions from Renesas	
Metrology Unit	03
Communication Unit	04
System Suggestions for Smart Meters	
Electricity Meters	07
Gas and Water Meters	08
Renesas Device Recommendations	
Devices	09
Evaluation Boards	10

Smart Meters realize Energy Efficiency and Smart Grids

Smart meters for power, gas, and water are spreading worldwide. Smart meters have two-way communication, which enable to track utility usage in real time by both utility supplier and consumer, also enable to start/reading/cutoff of supply remotely by supplier. It is also possible to implement a Home Energy Management System (HEMS) or Building Energy Management System (BEMS) that enables visualization of the electric power usage in individual homes or in entire buildings.

Further advances can be anticipated that will make the entire power grid smarter. Smarter power grids capable of dynamically optimizing supply will be essential once power grids begin to supply large amounts of electricity from renewable energy sources such as solar power.

The Burgeoning Market for Smart Meters

In Japan, following the April 2014 revision of the Act on Rationalization of Energy Use, 10 major electric power companies decided to introduce smart meters. Tokyo Electric Power Company plans to complete the transition to smart meters within its service area by 2020, and a similar transition is expected to be completed nationwide by 2024. In the United States more than 55 million smart electricity meters are already in use, accounting for more than 40% of households. In the EU the European Parliament issued a directive (Directive 2009/72/EC) in 2009 encouraging a transition to smart electricity meters and directing member nations to prepare a legal framework for the introduction of smart meters. Already both Sweden and Italy have reached nearly 100% adoption of smart meters. In addition to the advanced economies, interest in smart meters is high in emerging economies, with more and more countries planning adoption.

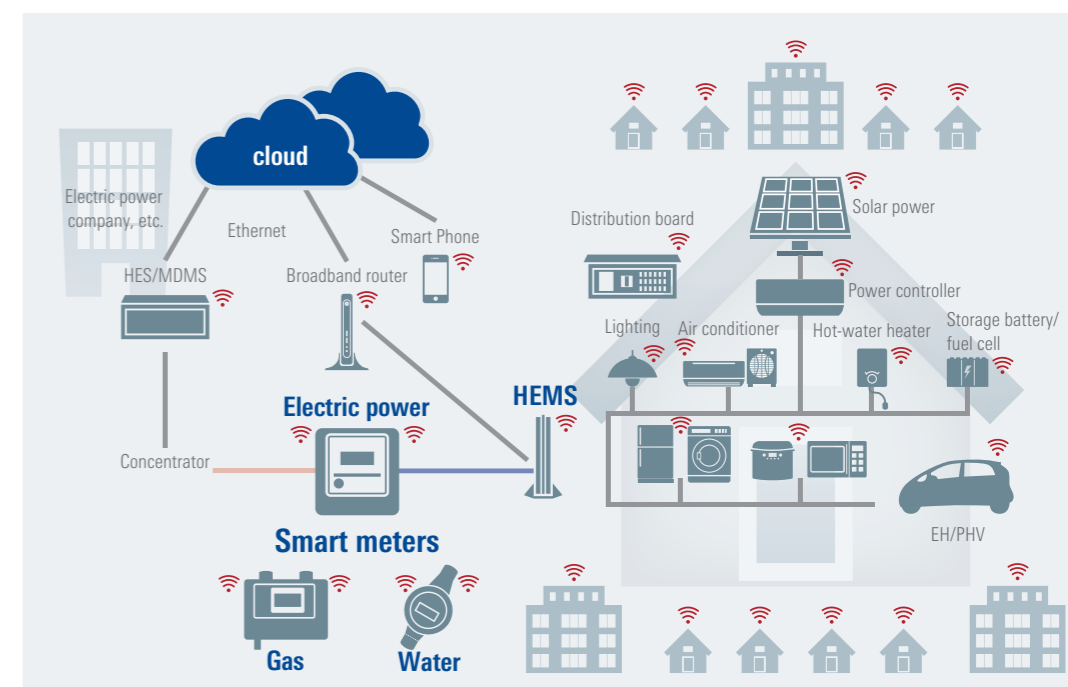

Figure 1:
Smart Meter
Communication

Smart Meter Solutions from Renesas

Metrology Unit

Metrology functionality is the purpose of a meter. Renesas development kits for smart electricity meters make development work more efficient.

RL78/I1B: A Microcontroller with Outstanding Energy Efficiency

The RL78/I1B is a microcontroller developed specifically for use in electricity meters. It delivers superior energy efficiency, reducing the power consumed by the meter itself to an absolute minimum. The RL78/I1B, a microcontroller developed specifically for use in smart meters, is used in the metrology unit of the electricity meters. The superior energy efficiency of the RL78/I1B reduces the electric power consumed by the meter itself to an absolute minimum. The metrology unit of the smart meter includes a clock function implemented by means of a real-time clock (RTC), which requires a backup battery. Previously, an external low-power RTC IC was used for this purpose, but the RL78/I1B includes a newly developed integrated ultra-low-power RTC. In addition, the on-chip oscillator has a function that automatically corrects the clock frequency within a range of $\pm 0.05\%$. This enables highly precise metrology without the need for external components. The oscillation circuit has a high tolerance for power surges caused by lightning, etc., ensuring stable operation in the harsh outdoor environments that smart meters must withstand.

Electricity Meter Development Kits You Can Start Using Right Away

Two development kits incorporating the RL78/I1B are available: the Analog Characteristic Evaluation Kit (Figure 2) and the Single-Phase Reference Meter (Figure 3). They include firmware developed based on Renesas extensive experience, such as electricity metering firmware and firmware for calibrating sensor readout values, so development can proceed more efficiently.

The Analog Characteristic Evaluation Kit can be used to confirm the compatibility of the RL78/I1B with the sensors currently in use for evaluation of characteristics. This kit enables developers to incorporate their own electricity metering knowhow into the RL78/I1B. The Single-Phase Reference Meter provides all basic functionality required for electricity metering. It includes everything needed to build a metrology unit that complies with the IEC 62053 international standard for electronic power metrology and delivers metrology accuracy of 0.5%.

Microcontroller RL78/I1C: Even More Advanced than the RL78/I1B, with Enhanced Security

The newly developed RL78/I1C microcontroller is even more advanced than its previous products the RL78/I1B, while maintaining superior measuring accuracy and energy efficiency. Its features include (1) hardware implementation of security functions, an industry first, (2) 30% better computational performance, up to 256 KB of ROM for code storage, and single-chip implementation of electric power metrology processing and DLMS* processing, resulting in approximately 30% lower power consumption than when two chips are used, and (3) availability of a Meter Analog Evaluation Kit and Meter Reference Kit, for a reduction of about 25% in the time and cost required for development.

The RL78/I1C also has enhanced event link controller and phase adjustment functions linked to a 24-bit $\Delta\Sigma$ A/D converter module with four channels and a 10-bit sequential-transformation power data A/D converter module with three channels. This provides seven channels for current and voltage metrology, as required for three-phase, four-wire metering. The RL78/I1C thus supports three-phase, four-wire metering in addition to conventional single-phase, two-wire and three-phase, three-wire configurations.

* DLMS stands for Device Language Message Specification, an IEC standard for converting electric power company meter metrology data.



Figure 2: Analog Characteristic Evaluation Kit



Figure 3: Single-Phase Reference Meter

Communication Unit

Communication links bring new value. Renesas' technological expertise can help reduce development time while making possible highly sophisticated smart meters.

Complex Smart Meter Communication Involving Multiple Standards

The biggest feature of smart meters is their communication functionality. This functionality links the power supplier (the electric power company) and the consumer (the device in the home) (see Figure 1 on page 2), but a variety of communication standards are used in different countries and regions.

In Japan, wireless multi-hop, 1:N wireless, and PLC are being considered for communication between the supplier and smart meter. For communication within the home (or building), Wi-SUN wireless communication, supplemented by power line communication (PLC), are the main methods employed.

Overseas, Wi-SUN and PLC hold the dominant positions, while a variety of other methods such as wireless multi-hop, 2G or 3G mobile communication, and ZigBee® wireless communication are under consideration.

Wi-SUN Sub-GHz Wireless Communication

Different frequency bands are used for sub-GHz wireless communication: 920 MHz in Japan, 915 MHz in the United States, and 863 MHz in Europe. Also, the Wi-SUN standard has been adopted with the aim of popularizing the Internet of Things (IoT) through applications such as machine-to-machine (M2M) communication and sensor networks.

Wi-SUN is a low-speed communication method employing IEEE 802.15.4g for the physical layer and IEEE 802.15.4e for the MAC layer. IEEE 802.15.4e and IEEE 802.15.4g are required items under the standard, but Wi-SUN extracts only the stipulations necessary for operation. Renesas has been involved since the beginning as one of the core players helping to determine the standard.

Features of Sub-GHz Communication

- 1 Covers a long range
- 2 High diffraction (ability to bypass obstacles)
- 3 Low interference
- 4 Low-speed (ability to maintain communication among multiple devices)

Wi-SUN is a registered trademark of Wi-SUN Alliance, Inc., Renesas is licensed to use this trademark.

PLC for Smart Meters, different from PLC for Data Transfer

Power line communication over wires designed to supply AC by overlaying an information signal at a higher frequency than the AC frequency (50 or 60 Hz) (Figure 4). PLC for smart meters is implemented using a variety of standards worldwide: G3 and PRIME are dominant in Europe, IEEE 1901.2 is used in the United States, Meters & More has been adopted Italy, and in Japan G3 format PLC (G3-PLC) is used. Renesas is involved in the standardization processes for all of these. In particular, Renesas has participated in all the working groups leading to the standardization of G3 and PRIME.

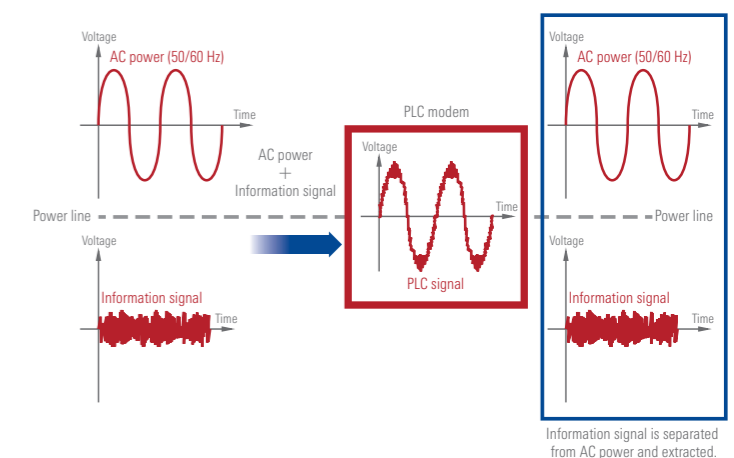

Figure 4: Basic Operating Principle of Power Line Communication (PLC)

Differences in Interoperability and Connectivity Due to How Communication Is Implemented

Communication is regulated by very strict standards. A newly developed communication unit must undergo and pass certification testing by the standardizing body before it can operate using the standard.

In addition, it must be possible to connect to other devices. Even if a device passes certification testing, a variety of factors other than the standard used affect connectivity. For this reason the standardizing body also conducts interoperability testing. Due to disparities in connectivity that can result from different implementations, it is in fact quite difficult to develop the communication unit of a smart meter. By using Renesas solutions that have completed the certification process, the development workload can be reduced substantially. This allows the developer to focus on enhancing the appeal of the smart meter itself and makes it possible to create a more competitive product.

Wi-SUN Platform

Tessera Technology Inc., a Renesas partner, offers development kits incorporating Renesas sub-GHz wireless devices. The Wi-SUN Basic Platform Low-Power Solution (Figure 5) employs an RL78/G1H microcontroller with an on-chip RF driver and delivers extremely low power consumption. The Wi-SUN Advanced Platform Advanced Functionality Solution (Figure 6) pairs an RX63N microcontroller with the RAA604S00 sub-GHz wireless communication chip to implement an array of functions with a high level of scalability.

This kit and the software stack developed by Renesas using it as a platform have been certified by the Wi-SUN Alliance. It is officially designated by the Wi-SUN Alliance as a Certified Test Bed Unit (CTBU). The two kits described above dramatically lower the hurdles associated with connectivity testing.

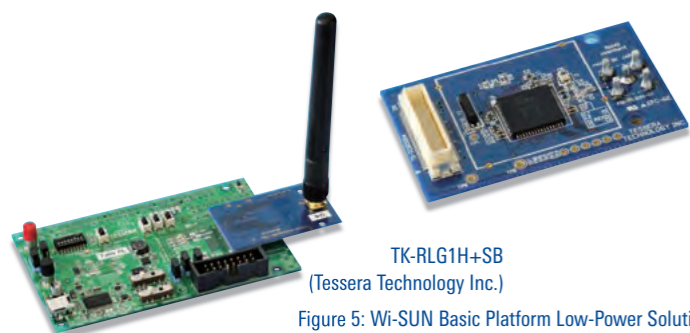

Figure 5: Wi-SUN Basic Platform Low-Power Solution

Sub-GHz Wireless Packet Capture Solution for Visualizing Wireless Communication

Analyzing the communication status can be difficult since the strength of wireless signals changes in response to variations in environmental conditions. The Sub-GHz Wireless Packet Capture Solution (Figure 7) from Renesas provides a way to visualize and analyze wireless communication data. It uses the RL604S Stick, a compact unit that connects via USB and combines the RL78/G14 and RAA604S00, to capture IEEE 802.15.4g/e wireless packets. The frame contents of the captured wireless packets can then be analyzed by using a GUI Tool that runs on Microsoft Windows.

The software also interoperates with Wireshark, an open-source packet analyzer, enabling analytical display of the frame contents of higher-level layers. This solution makes it possible to analyze and evaluate wireless connectivity in a real-world environment.

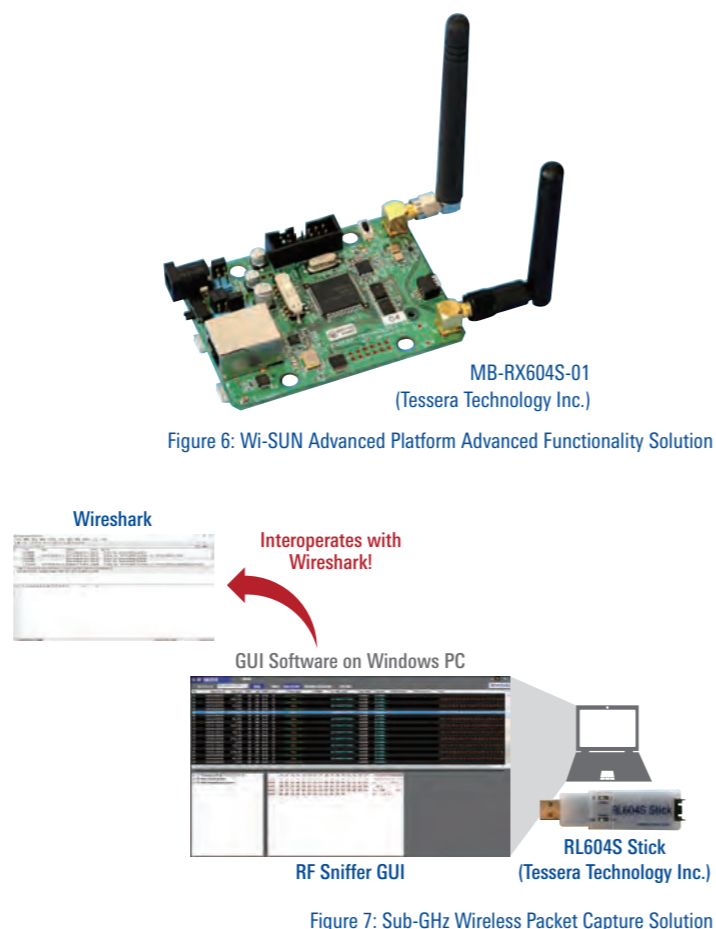

Figure 6: Wi-SUN Advanced Platform Advanced Functionality Solution

Figure 7: Sub-GHz Wireless Packet Capture Solution

Development Kit with Modem Supporting Main PLC Standards

The PLC Development Kit (Figure 8) from Renesas consists of the GCPX3 Evaluation Kit equipped with the R9A06G037 PLC modem chip, software, and documentation. The R9A06G037 modem supports both the G3-PLC and PRIME PLC standards, and the Renesas protocol stack is certified for standards compliance. This evaluation kit is also certified for technical standards compliance in Japan. When using the supplied software library, the modem provides full support for the G3-PLC standard (Europe, United States, and Japan). There is no need to switch out the modem chip in order to support specific countries or regions, and this boosts development efficiency and productivity. Moving forward, Renesas is working to provide an even broader solution by extending support beyond G3-PLC and PRIME to include IEEE 1901.2, which is used in the United States, and the newest version of PRIME, v. 1.4.



Figure 8: Board Included in GCPX3 Evaluation Kit

PLC Network Evaluation Tool for Visualization and Building Networks for Power Line Communication

With power line communication it is important to analyze the communication state because this tends to vary due to changes in the environmental such as noise or impedance on the power line. The PLC Network Evaluation Tool (Figure 9) from Renesas can be used to visualize power line communication data and communication quality, and it provides an analytical display of the communication state. The PLC Network Evaluation Tool enables the user to build a network consisting of multiple nodes and to visualize the state of the network. A GUI Tool that runs on Microsoft Windows shows an analytical display of communication data and the network state. This evaluation tool can be used to analyze and evaluate power line connectivity in a real-world environment.

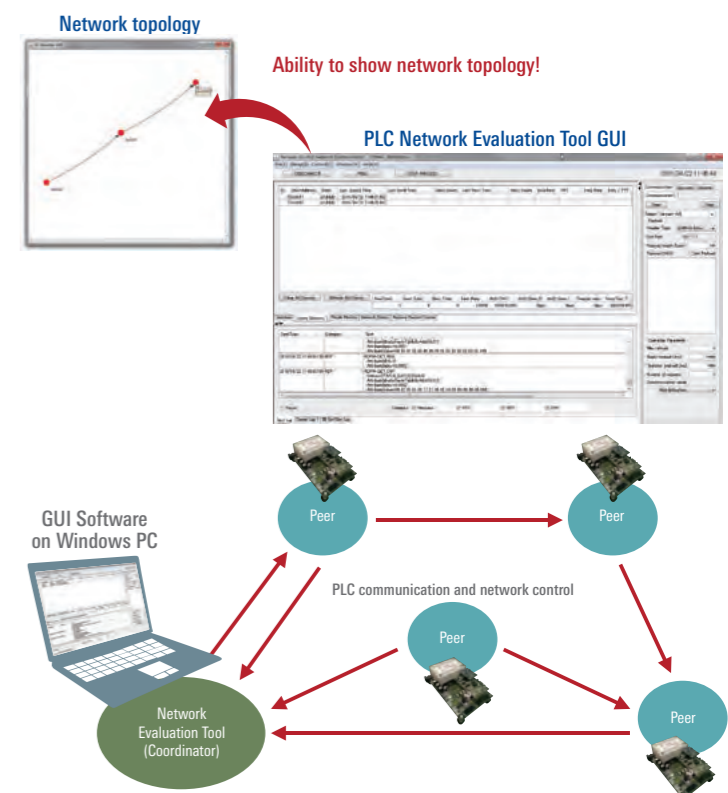

Figure 9: PLC Network Evaluation Tool

System Suggestions for Smart Meters

Electricity Meters

Renesas offers an extensive lineup of microcontrollers for smart electricity meters, and solutions to meet a range of customer requirements.

Smart Electricity Meter Solutions

A smart electricity meter consists primarily of a metrology unit and a communication unit. As metrology unit solutions, Renesas offers the RL78/11B and its advanced products the RL78/11C, which feature an on-chip ultra-low-power RTC, and the RX21A Group, with an on-chip 24-bit $\Delta\Sigma$ ADC to reduce the number of external components and associated costs. When an external $\Delta\Sigma$ ADC is used, available the RL78L1x, RX210, and RX220. As communication unit solutions, Renesas offers microcontrollers with features such as an on-chip ultra-low-power sub-GHz RF driver IC with IEEE 802.15.4g/e support, essential for Wi-SUN applications, and support for international power line communication standards (G3-PLC and PRIME).

Renesas offers an extensive lineup of microcontrollers for smart electricity meters to meet a broad range of customer requirements.

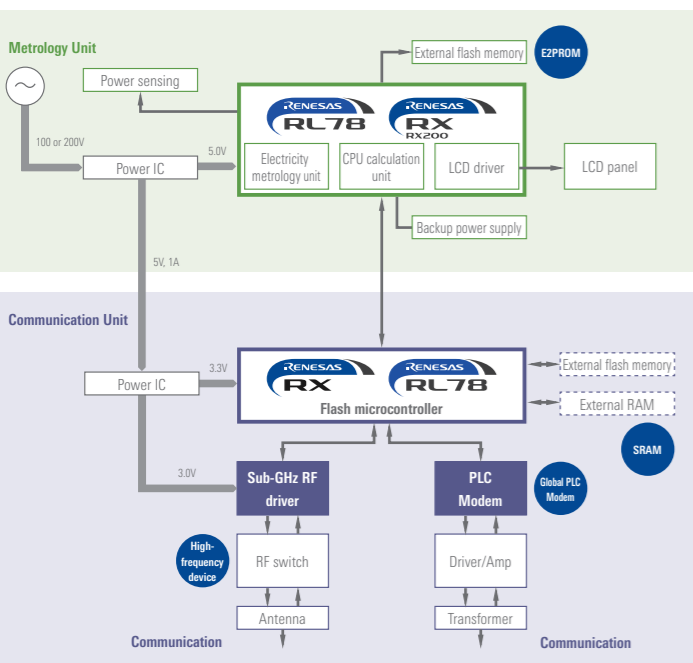

Figure 10: Smart Electricity Meter System Configuration Example

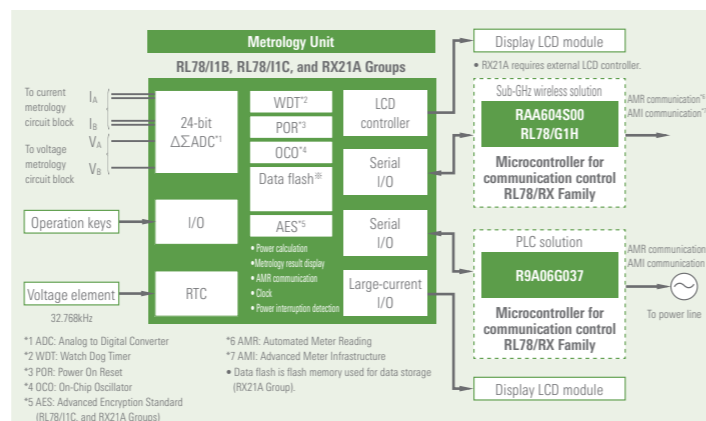

Figure 11: Metrology Unit System Configuration Example

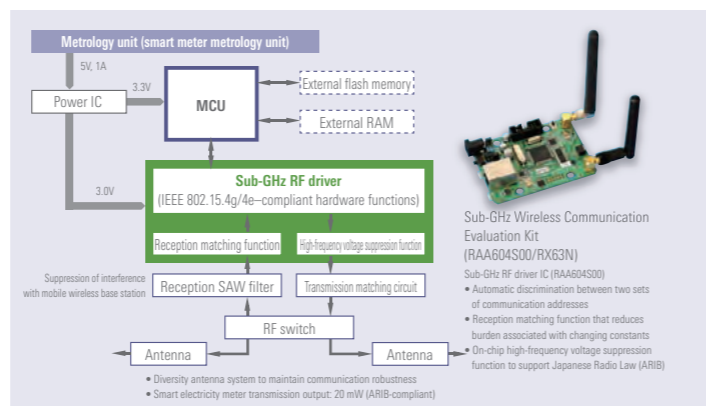

Figure 12: Communication Unit Sub-GHz Wireless Communication System Configuration Example

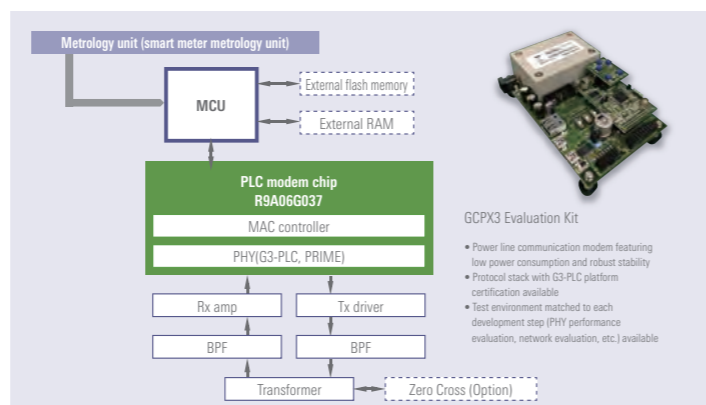

Figure 13: Communication Unit Power Line Communication (PLC) System Configuration Example

Gas and Water Meters

Renesas offers a multitude of microcontrollers combining low power consumption and excellent reliability as solutions for gas and water meters.

Gas and Water Meter Solutions

Gas meters must measure and display the amount of gas used, and in Japan they must also provide safety functions to automatically detect abnormal states and cut off the gas supply. This means that the microcontrollers used in gas meters require the ability to connect to sensors of various types. The Japanese Measurement Law stipulates replacement limits of 10 years for gas meters and 8 years for water meters, and the batteries incorporated into these meters must have operational lifetimes of at least those durations. These applications therefore require microcontrollers with ultra-low current consumption while providing improved failsafe functions such as a high-safety watchdog timer (WDT) and an on-chip oscillation circuit that is highly resistant to oscillation errors. In addition, a broad lineup of package options enables customers to select a microcontroller with precisely the right functions and size for the gas meter or water meter. The RL78/11D features enhanced analog functions such as op-amp, 12-bit A/D converter, and window comparator; low current consumption of 124 μ A when operating at 1 MHz; and medium-speed oscillator with a fast wakeup time of 4 μ sec. A solution is available for measuring the flow metrology unit rotation in gas or water meters using the RL78/11D.

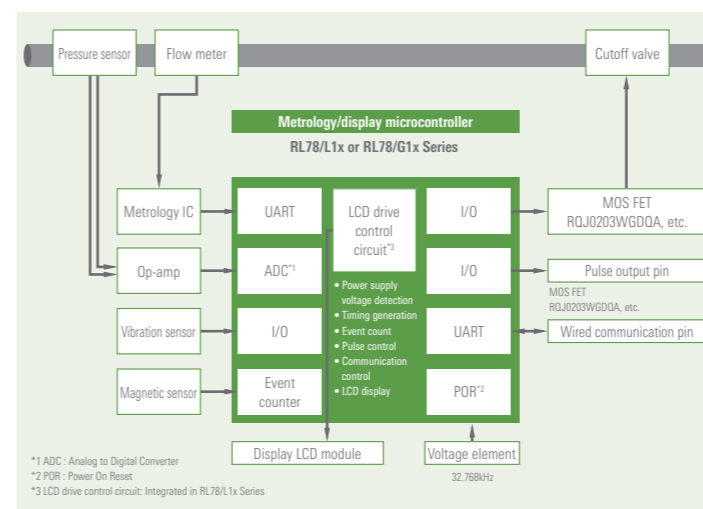

Figure 14: Gas Meter Configuration Example

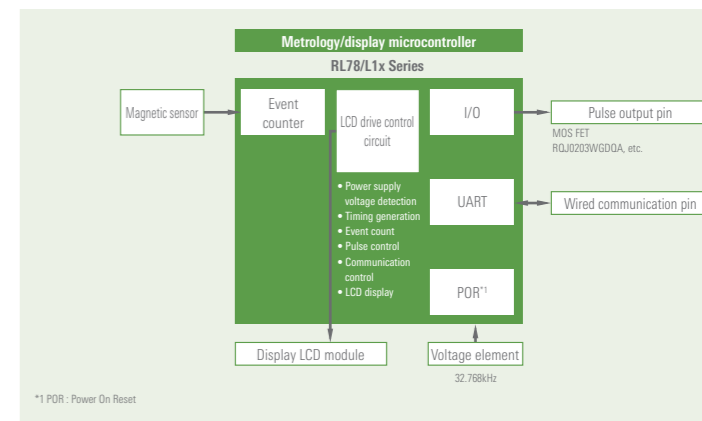

Figure 15: Water Meter Configuration Example

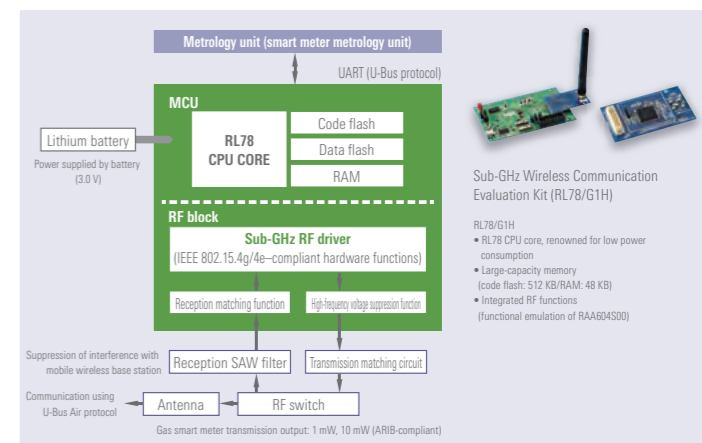

Figure 16: Communication Unit Sub-GHz Wireless Communication System Configuration Example

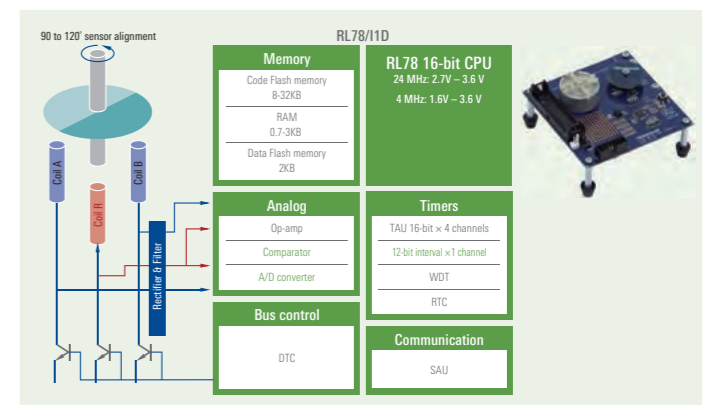

Figure 17: Metrology Unit (Flow Meter)

Renesas Device Recommendations

Devices

Block	Product Classification	Recommended Product	Features
Metrology	Microcontroller	RL78/I1B (electricity meter metrology ASSP)	<ul style="list-style-type: none"> ■ 16-bit CPU ■ On-chip memory ■ System ■ LCD drive <ul style="list-style-type: none"> • Max. operating frequency: 24 MHz, multiply/divide/multiply-and-accumulate instructions • Flash memory: 64/128 KB • SRAM: 6/8 KB • HOCO clock frequency correction function • Battery backup function • 8 com. × 38 seg./6 com. × 40 seg./4 com. × 42 seg. • LCD drive power supply generation: Internal voltage boosting method/capacitor split method/external resistance division • 24-bit $\Delta\Sigma$ A/D converter × 4 channels • 8-/10-bit ADC × 6 channels, temperature sensor × 1 channel • LQFP 80-/100-pins <ul style="list-style-type: none"> ■ Analog ■ Package
	Microcontroller	RL78/I1C (electricity meter metrology ASSP)	<ul style="list-style-type: none"> ■ 16-bit CPU ■ On-chip memory ■ System ■ LCD drive <ul style="list-style-type: none"> • Max. operating frequency: 32 MHz, multiply/divide/multiply-and-accumulate instructions, 32-bit multiply-and-accumulate circuit • Flash memory: 64/128/256 KB • Data flash: 2 KB • SRAM: 6/8/16 KB • AES hardware (GCM/ECB/CBC mode) • Independent power supply RTC system • HOCO clock frequency correction function • Battery backup function • ELC • 8 com. × 38 seg./6 com. × 40 seg./4 com. × 42 seg. • LCD drive power supply generation: Internal voltage boosting method/capacitor split method/external resistance division • 24-bit $\Delta\Sigma$ A/D converter × 4 channels • 8-/10-bit ADC × 6 channels, temperature sensor × 1 channel • LQFP 64-/80-/100-pins <ul style="list-style-type: none"> ■ Analog ■ Package
	Microcontroller	RL78/I1D	<ul style="list-style-type: none"> ■ 16-bit CPU ■ On-chip memory ■ Safety functions ■ Analog ■ Package <ul style="list-style-type: none"> • Max. operating frequency: 24 MHz, multiply/divide/multiply-and-accumulate instructions • Flash memory: 8/16/32 KB • SRAM: 0.7/2/3 KB • Data flash: 2 KB • IEC 60730 support • Op-amp, 12-bit A/D converter, comparator • 20- to 48-pin
	Microcontroller	RX21A (advanced functionality microcontroller for meters)	<ul style="list-style-type: none"> ■ 32-bit CPU ■ On-chip memory ■ System ■ Analog ■ Encryption unit ■ Package <ul style="list-style-type: none"> • Max. operating frequency: 50 MHz, multiply/divide/multiply-and-accumulate instructions • Flash memory: 512/384/256 KB • SRAM: 64/32 KB • Data flash: 8 KB • On-chip HOCO, LOCO, and 32 kHz sub-clock • ELC for Fast startup and low power consumption • 24-bit $\Delta\Sigma$ A/D converter × 7 channels • 10-bit ADC × 7 channels • AES 128-/192-/256-bit • Memory protection unit • LQFP 64-/80-/100-pins
Control microcontroller	Microcontroller	RL78/G13, G14	<ul style="list-style-type: none"> ■ 16-bit CPU ■ On-chip memory ■ Safety functions ■ Analog ■ Package <ul style="list-style-type: none"> • Max. operating frequency: 24 MHz, multiply/divide/multiply-and-accumulate instructions • Flash memory: 16 to 512 KB • SRAM: 2 to 32 KB (G13), 2.5 to 48 KB (G14) • Data flash: 4/8 KB • Support for European household appliance safety standard (IEC/UL 60730) • 10-bit ADC × 26 channels (G13), 20 channels (G14) • 20- to 128-pin (G13), 30- to 100-pin (G14)
	Microcontroller	RL78/L1x (with advanced functionality LCD driver)	<ul style="list-style-type: none"> ■ 16-bit CPU ■ On-chip memory ■ LCD drive ■ Package <ul style="list-style-type: none"> • Max. operating frequency: 24 MHz • Flash memory: up to 256 KB • SRAM: up to 16 KB • Data flash: 8 KB • Internal voltage boosting method, capacitor split method, and external resistance division support • Max. 416-segment display • 32- to 100-pins
	Microcontroller	RX200 Series (high-performance, low-power-consumption microcontroller)	<ul style="list-style-type: none"> ■ 32-bit CPU ■ Low power ■ On-chip memory ■ Safety functions ■ Encryption unit ■ Package <ul style="list-style-type: none"> • FPU and DSP instruction support • Operation: 0.12 mA/MHz, standby current: 0.8 μA • Flash memory: up to 1 MB • SRAM: up to 96 KB • Data flash: 8 KB • Frequency error monitoring, A/D self-diagnostics • IEC 60730 support • AES 128-/192-/256-bit • Memory protection unit • 48- to 144-pins

Block	Product Classification	Recommended Product	Features
Control microcontroller	Microcontroller	RX600 Series (microcontroller with on-chip high-speed, large-capacity flash memory)	<ul style="list-style-type: none"> ■ 32-bit CPU ■ On-chip memory ■ Safety functions ■ Encryption unit ■ Package <ul style="list-style-type: none"> • FPU and DSP instruction support • Flash memory: up to 2 MB • SRAM: up to 256 KB • Data flash: 32 KB • Frequency error monitoring, A/D self-diagnostics • IEC 60730 and IEC 61508 support • AES 128-/192-/256-bit • Memory protection unit • 48- to 176-pins
Communication	Sub-GHz RF driver	RAA604S00	<ul style="list-style-type: none"> ■ Operating frequency ■ Modulation method/data rate (kbps) ■ Current consumption (Vcc = 3.3 V, typ.) <ul style="list-style-type: none"> • 863 MHz to 928 MHz • 2FSK/GFSK: 10/20/40/50/100/150/200/300 • 4FSK/GFSK: 200/400 • Reception: 6.3 mA, reception standby: 5.8 mA • Transmission: 20 mA (+10 dBm)
	Sub-GHz RF driver	RAA604S00	<ul style="list-style-type: none"> ■ Reception sensitivity ■ IEEE 802.15.4g/4e-compliant hardware functions ■ Package <ul style="list-style-type: none"> • -105dBm (2GFSK 100Kbps, BER<0.1%) • Automatic discrimination between two sets of communication addresses • Automatic generation of transmission frames • Automatic ACK return/receive • 32-pin QFN
	Microcontroller with on-chip sub-GHz RF driver	R5F11FLx (DR178/G1HD)	<ul style="list-style-type: none"> ■ 16-bit CPU ■ On-chip memory ■ RF block <ul style="list-style-type: none"> • Max. operating frequency: 32 MHz, multiply/divide/multiply-and-accumulate instructions • Flash memory: 256 to 512 MB • SRAM: 24 to 48 KB • Data flash: 8 KB • Operating frequency range <ul style="list-style-type: none"> — 863 MHz to 928 MHz — 2FSK/GFSK: 10/20/40/50/100/150/200/300 — 4FSK/GFSK: 200/400 • Modulation method/data rate (kbps): <ul style="list-style-type: none"> — Reception: 6.3 mA, reception standby: 5.8 mA — Transmission: 20 mA (+10 dBm) • Current consumption (RF block: Vcc = 3.3 V, typ.) <ul style="list-style-type: none"> — Reception: 6.3 mA, reception standby: 5.8 mA — Transmission: 20 mA (+10 dBm) • Reception sensitivity <ul style="list-style-type: none"> — -104 dBm (GFSK 100 Kbps, BER < 0.1%) • IEEE 802.15.4g/4e-compliant hardware functions <ul style="list-style-type: none"> — Automatic discrimination between two sets of communication addresses — Automatic generation of transmission frames — Automatic ACK return/receive <ul style="list-style-type: none"> ■ Communication interfaces ■ Analog ■ Package <ul style="list-style-type: none"> • CSI/UART (exclusive): 2 channels • CSI: 1 channel • I²C: 2 channels • 10-bit ADC × 6 channels • 64-pin QFN
	PLC SOC	R9A06G037 (narrow-band PLC modem chip)	<ul style="list-style-type: none"> ■ DSP ■ MAC controller ■ AFE ■ Encryption unit ■ Package <ul style="list-style-type: none"> • G3-PLC, PRIME PHY algorithm support • Frequency band: Up to 500 kHz • CSMA/CA protocol support • G3-PLC and PRIME support • On-chip ADC and DAC • On-chip adaptive gain amplifier • On-chip Tx filter • AES 128-bit hardware accelerator • 64-pin QFN

Evaluation Boards

Name	Product Number	Remarks
Single-Phase Reference Meter	RTE510MPG0TGB0000R	
Analog Characteristic Evaluation Kit	—	
Renesas Starter Kit	Available for all RL78 and RLRX product models	
CPU board	Available for all RL78 and RLRX product models	
Sub-GHz Wireless Communication Evaluation Kit	MB-RX604S-01 TK-RLG1H+SB RL604S Stick	Tessera Technology Inc.
GCPX3 Evaluation Kit	RTK0EE0003D01002BJ (international version) RTK0EE0003D02002BJ (Japan version)	

Notice

1. Descriptions of circuits, software and other related information in this document are provided only to illustrate the operation of semiconductor products and application examples. You are fully responsible for the incorporation or any other use of the circuits, software, and information in the design of your product or system. Renesas Electronics disclaims any and all liability for any losses and damages incurred by you or third parties arising from the use of these circuits, software, or information.
 2. Renesas Electronics hereby expressly disclaims any warranties against and liability for infringement or any other disputes involving patents, copyrights, or other intellectual property rights of third parties, by or arising from the use of Renesas Electronics products or technical information described in this document, including but not limited to, the product data, drawing, chart, program, algorithm, application examples.
 3. No license, express, implied or otherwise, is granted hereby under any patents, copyrights or other intellectual property rights of Renesas Electronics or others.
 4. You shall not alter, modify, copy, or otherwise misappropriate any Renesas Electronics product, whether in whole or in part. Renesas Electronics disclaims any and all liability for any losses or damages incurred by you or third parties arising from such alteration, modification, copy or otherwise misappropriation of Renesas Electronics products.
 5. Renesas Electronics products are classified according to the following two quality grades: "Standard" and "High Quality". The intended applications for each Renesas Electronics product depends on the product's quality grade, as indicated below.
 "Standard": Computers; office equipment; communications equipment; test and measurement equipment; audio and visual equipment; home electronic appliances; machine tools; personal electronic equipment; and industrial robots etc.
 "High Quality": Transportation equipment (automobiles, trains, ships, etc.); traffic control (traffic lights); large-scale communication equipment; key financial terminal systems; safety control equipment; etc.
 Renesas Electronics products are neither intended nor authorized for use in products or systems that may pose a direct threat to human life or bodily injury (artificial life support devices or systems, surgical implantations etc.), or may cause serious property damages (space and undersea repeaters; nuclear power control systems; aircraft control systems; key plant systems; military equipment, etc.). Renesas Electronics disclaims any and all liability for any damages or losses incurred by you or third parties arising from the use of any Renesas Electronics product for which the product is not intended by Renesas Electronics.
 6. When using the Renesas Electronics products, refer to the latest product information (data sheets, user's manuals, application notes, "General Notes for Handling and Using Semiconductor Devices" in the reliability handbook, etc.), and ensure that usage conditions are within the ranges specified by Renesas Electronics with respect to maximum ratings, operating power supply voltage range, heat radiation characteristics, installation, etc. Renesas Electronics disclaims any and all liability for any malfunctions or failure or accident arising out of the use of Renesas Electronics products beyond such specified ranges.
 7. Although Renesas Electronics endeavors to improve the quality and reliability of Renesas Electronics products, semiconductor products have specific characteristics such as the occurrence of failure at a certain rate and malfunctions under certain use conditions. Further, Renesas Electronics products are not subject to radiation resistance design. Please ensure to implement safety measures to guard them against the possibility of bodily injury, injury or damage caused by fire, and social damage in the event of failure or malfunction of Renesas Electronics products, such as safety design for hardware and software including but not limited to redundancy, fire control and malfunction prevention, appropriate treatment for aging degradation or any other appropriate measures by your own responsibility as warranty for your products/system. Because the evaluation of microcomputer software alone is very difficult and not practical, please evaluate the safety of the final products or systems manufactured by you.
 8. Please contact a Renesas Electronics sales office for details as to environmental matters such as the environmental compatibility of each Renesas Electronics product. Please investigate applicable laws and regulations that regulate the inclusion or use of controlled substances, including without limitation, the EU RoHS Directive carefully and sufficiently and use Renesas Electronics products in compliance with all these applicable laws and regulations. Renesas Electronics disclaims any and all liability for damages or losses occurring as a result of your noncompliance with applicable laws and regulations.
 9. Renesas Electronics products and technologies shall not be used for or incorporated into any products or systems whose manufacture, use, or sale is prohibited under any applicable domestic or foreign laws or regulations. You shall not use Renesas Electronics products or technologies for (1) any purpose relating to the development, design, manufacture, use, stockpiling, etc., of weapons of mass destruction, such as nuclear weapons, chemical weapons, or biological weapons, or missiles (including unmanned aerial vehicles (UAVs)) for delivering such weapons, (2) any purpose relating to the development, design, manufacture, or use of conventional weapons, or (3) any other purpose of disturbing international peace and security, and you shall not sell, export, lease, transfer, or release Renesas Electronics products or technologies to any third party whether directly or indirectly with knowledge or reason to know that the third party or any other party will engage in the activities described above. When exporting, selling, transferring, etc., Renesas Electronics products or technologies, you shall comply with any applicable export control laws and regulations promulgated and administered by the governments of the countries asserting jurisdiction over the parties or transactions.
 10. Please acknowledge and agree that you shall bear all the losses and damages which are incurred from the misuse or violation of the terms and conditions described in this document, including this notice, and hold Renesas Electronics harmless, if such misuse or violation results from your resale or making Renesas Electronics products available any third party.
 11. This document shall not be reprinted, reproduced or duplicated in any form, in whole or in part, without prior written consent of Renesas Electronics.
 12. Please contact a Renesas Electronics sales office if you have any questions regarding the information contained in this document or Renesas Electronics products.
- (Note 1) "Renesas Electronics" as used in this document means Renesas Electronics Corporation and also includes its majority-owned subsidiaries.
 (Note 2) "Renesas Electronics product(s)" means any product developed or manufactured by or for Renesas Electronics.

(Rev.3.0-1 November 2016)

SALES OFFICES

Refer to "<http://www.renesas.com/>" for the latest and detailed information.

Renesas Electronics America Inc.

2801 Scott Boulevard Santa Clara, CA 95050-2549, U.S.A.
 Tel: +1-408-588-6000, Fax: +1-408-588-6130

Renesas Electronics Canada Limited

9251 Yonge Street, Suite 8309 Richmond Hill, Ontario Canada L4C 9T3
 Tel: +1-905-237-2004

Renesas Electronics Europe Limited

Dukes Meadow, Millboard Road, Bourne End, Buckinghamshire, SL8 5FH, U.K
 Tel: +44-1628-585-100, Fax: +44-1628-585-900

Renesas Electronics Europe GmbH

Arcadiastrasse 10, 40472 Düsseldorf, Germany
 Tel: +49-211-6503-0, Fax: +49-211-6503-1327

Renesas Electronics (China) Co., Ltd.

Room 1709, Quantum Plaza, No.27 ZhiChunLu Haidian District, Beijing 100191, P.R.China
 Tel: +86-10-8235-1155, Fax: +86-10-8235-7679

Renesas Electronics (Shanghai) Co., Ltd.

Unit 301, Tower A, Central Towers, 555 Langao Road, Putuo District, Shanghai, P. R. China 200333
 Tel: +86-21-2226-0888, Fax: +86-21-2226-0999

Renesas Electronics Hong Kong Limited

Unit 1601-1611, 16/F., Tower 2, Grand Century Place, 193 Prince Edward Road West, Mongkok, Kowloon, Hong Kong
 Tel: +852-2265-6688, Fax: +852-2886-9022

Renesas Electronics Taiwan Co., Ltd.

13F, No. 363, Fu Shing North Road, Taipei 10543, Taiwan
 Tel: +886-2-8175-9600, Fax: +886-2-8175-9670

Renesas Electronics Singapore Pte. Ltd.

80 Bondemeer Road, Unit #06-02 Hylux Innovation Centre, Singapore 339949
 Tel: +65-6213-0200, Fax: +65-6213-0300

Renesas Electronics Malaysia Sdn.Bhd.

Unit 1207, Block B, Menara Amcorp, Amcorp Trade Centre, No. 18, Jln Persiaran Barat, 46050 Petaling Jaya, Selangor Darul Ehsan, Malaysia
 Tel: +60-3-7955-9390, Fax: +60-3-7955-9510

Renesas Electronics India Pvt. Ltd.

No.777C, 100 Feet Road, HAL II Stage, Indiranagar, Bangalore, India
 Tel: +91-80-67208700, Fax: +91-80-67208777

Renesas Electronics Korea Co., Ltd.

12F., 234 Teheran-ro, Gangnam-Gu, Seoul, 135-080, Korea
 Tel: +82-2-558-3737, Fax: +82-2-558-5141