

Introduction

Slave SPI can provide data conversion, and transfer data from one device to others. Also, when parallel ports are just not feasible, a single serial port gets used. This serial signal can be converted to parallel information by the SLG46620 IC. Please note that the maximum number of bits which can be converted is 8 at a time.

SPI converter circuit design

As shown in Figure 1, using two main blocks (SPI block and SPI Parallel Output block), it is possible to perform this conversion.

In this example, SPI serial data is input at Pin 10. nCSB is input at Pin 5, and SCLK is input at Pin 7. The converted SPI Parallel Out signals can then go directly to output pins, or sent to other on-chip blocks (SPI parallel output option should be enabled). In this example they are connected to PINs 13 to 20.

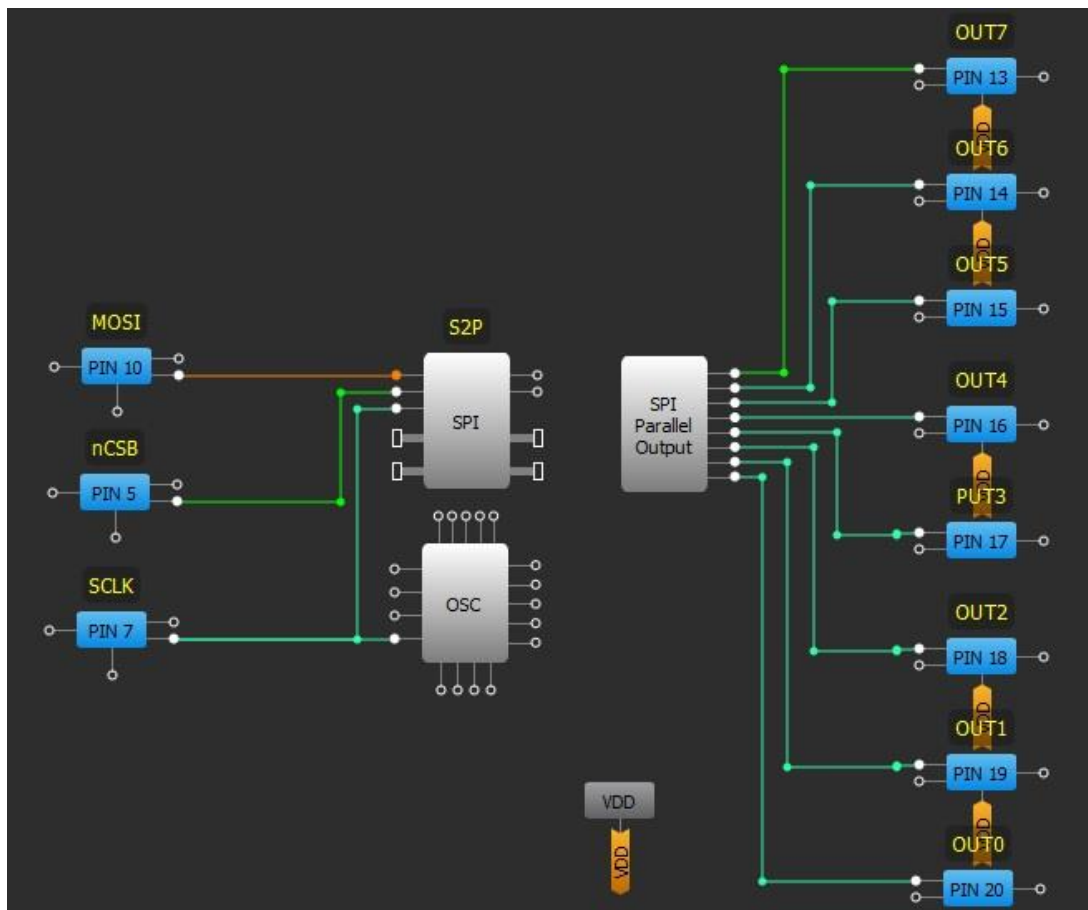

Figure 1. SPI converter circuit

SPI converter circuit analysis

Only after the nCSB signal goes from HIGH to LOW can valid serial data input be started. Depending on SPI 1-bit CPOL and CPHA register settings, information input may happen on rising or falling SCLK signal edges, and SCLK signal may be inverted or not. See clock phase and polarity description with respect to the data in the SLG46620 datasheet file.

First case (CPHA = 0; CPOL = 0)

In this case SCLK signal is not inverted and MOSI input is written on the rising edge of the SCLK signal. See block configuration in Figure 2.

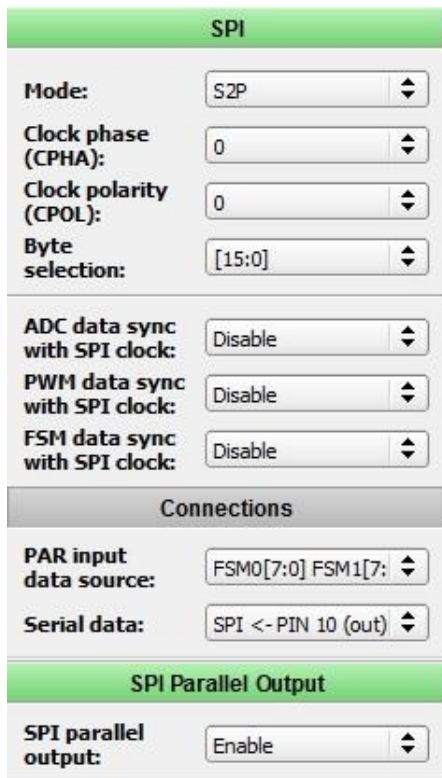
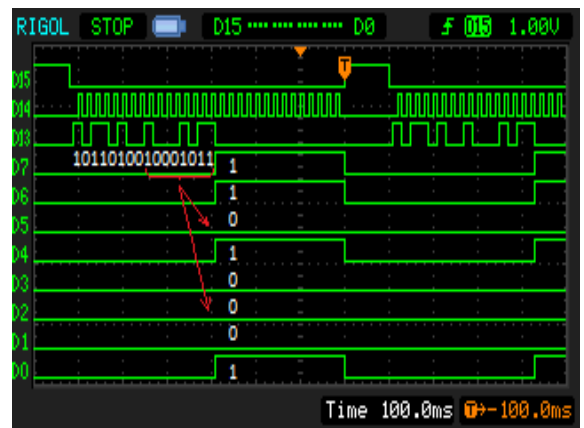

Figure 2. SPI and SPI Parallel Output block configuration

Byte selection option determines whether it will be 16-bit ([15:0] option) or 8-bit ([7:0] option) input. In the case of 16-bit serial input, the last 8-bit data will be presented on SPI Parallel Output after 16th SCLK pulse falling edge. The first 8-bit data will be ignored. (See figure 3).



(D15 – nCSB; D14 – SCLK; D13 – MOSI; D7..D0 – OUT0..OUT7)

Figure 3. SPI converter functional waveforms (Byte selection = [15:0])

Figure 4 shows the case when Byte selection value is [7;0]. In this case, parallel data output will be presented after the 8th SCLK pulse falling edge.

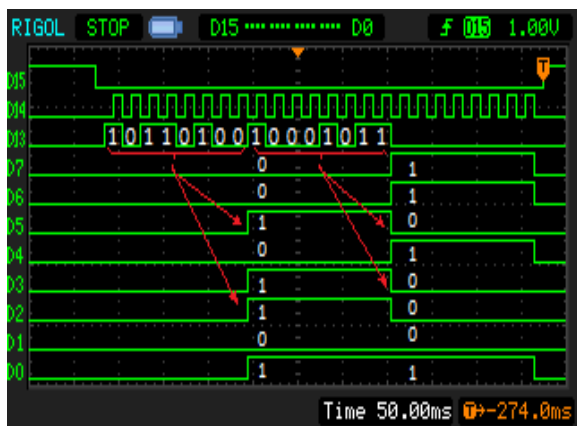

(D15 – nCSB; D14 – SCLK; D13 – MOSI; D7..D0 – OUT0..OUT7)

Figure 4. SPI converter functional waveforms (Byte selection = [7:0])

The parallel output data will hold until the next conversion begins, or when nCSB goes HIGH.

Second case (CPHA = 0; CPOL = 1)

In this case SCLK signal is inverted and MOSI input data are written by the falling edge of SCLK signal. See block configuration in Figure 5.

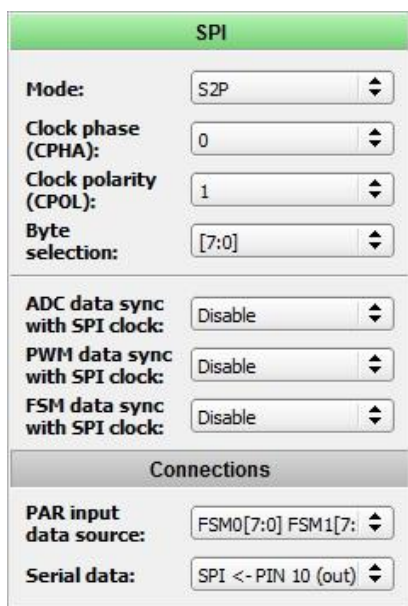
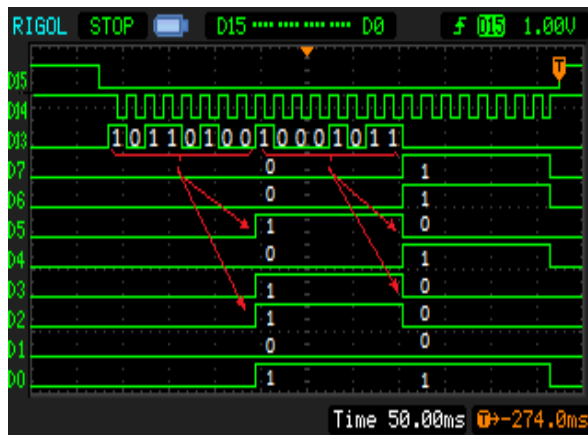

Figure 5. SPI block configuration

Parallel data output will be presented after the 8th SCLK pulse rising edge. (See Figure 6).



(D15 – nCSB; D14 – SCLK; D13 – MOSI; D7..D0 – OUT0..OUT7)

Figure 6. SPI converter functional waveforms

Third case (CPHA = 1; CPOL = 0)

In this case SCLK signal is not inverted and MOSI input data are written by the falling edge of SCLK signal. See block configuration in Figure 7.

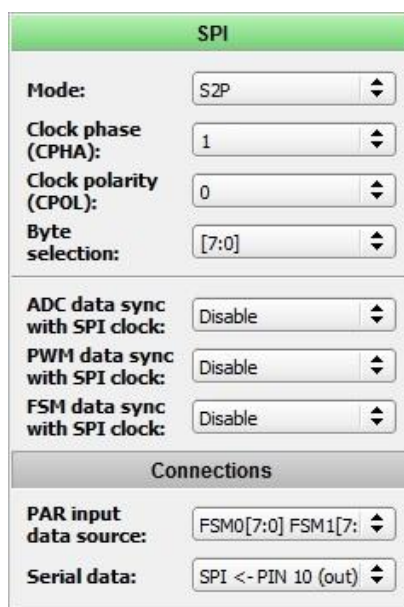
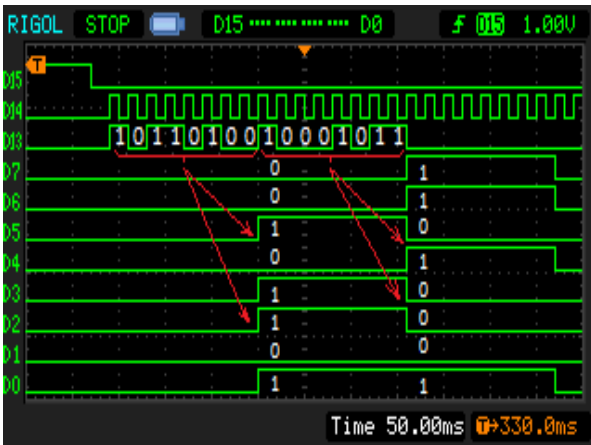

Figure 7. SPI block configuration

Parallel data output will be presented after the 9th SCLK pulse rising edge. (See Figure 8).



(D15 – nCSB; D14 – SCLK; D13 – MOSI; D7..D0 – OUT0..OUT7)

Figure 8. SPI converter functional waveforms

Fourth case (CPHA = 1; CPOL = 1)

In this case SCLK signal is inverted and MOSI input is written by the falling edge of SCLK signal. See block configuration in Figure 9.

Parallel data output will be presented after the 9th SCLK pulse falling edge. (See Figure 10).

Conclusion

This circuit performs conversion of a serial signal such as SPI, into parallel. Each of the parallel bits are then available for connection to other circuitry inside the SLG46620 IC, or driven to external pins for external device control.



Figure 9. SPI block configuration

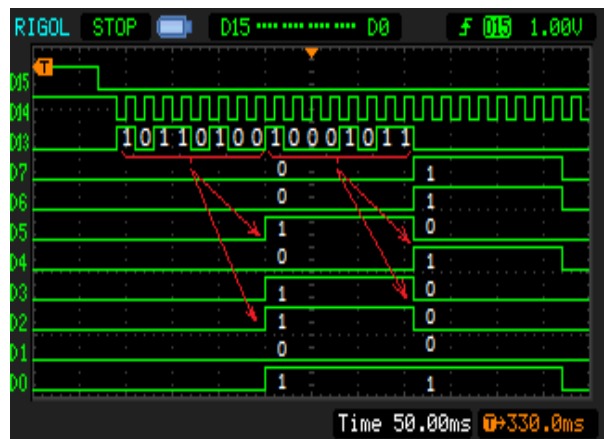

(D15 – nCSB; D14 – SCLK; D13 – MOSI; D7..D0 – OUT0..OUT7)

Figure 10. SPI converter functional waveforms

IMPORTANT NOTICE AND DISCLAIMER

RENESAS ELECTRONICS CORPORATION AND ITS SUBSIDIARIES (“RENESAS”) PROVIDES TECHNICAL SPECIFICATIONS AND RELIABILITY DATA (INCLUDING DATASHEETS), DESIGN RESOURCES (INCLUDING REFERENCE DESIGNS), APPLICATION OR OTHER DESIGN ADVICE, WEB TOOLS, SAFETY INFORMATION, AND OTHER RESOURCES “AS IS” AND WITH ALL FAULTS, AND DISCLAIMS ALL WARRANTIES, EXPRESS OR IMPLIED, INCLUDING, WITHOUT LIMITATION, ANY IMPLIED WARRANTIES OF MERCHANTABILITY, FITNESS FOR A PARTICULAR PURPOSE, OR NON-INFRINGEMENT OF THIRD-PARTY INTELLECTUAL PROPERTY RIGHTS.

These resources are intended for developers who are designing with Renesas products. You are solely responsible for (1) selecting the appropriate products for your application, (2) designing, validating, and testing your application, and (3) ensuring your application meets applicable standards, and any other safety, security, or other requirements. These resources are subject to change without notice. Renesas grants you permission to use these resources only to develop an application that uses Renesas products. Other reproduction or use of these resources is strictly prohibited. No license is granted to any other Renesas intellectual property or to any third-party intellectual property. Renesas disclaims responsibility for, and you will fully indemnify Renesas and its representatives against, any claims, damages, costs, losses, or liabilities arising from your use of these resources. Renesas' products are provided only subject to Renesas' Terms and Conditions of Sale or other applicable terms agreed to in writing. No use of any Renesas resources expands or otherwise alters any applicable warranties or warranty disclaimers for these products.

(Disclaimer Rev.1.01 Jan 2024)

Corporate Headquarters

TOYOSU FORESIA, 3-2-24 Toyosu,
Koto-ku, Tokyo 135-0061, Japan
www.renesas.com

Trademarks

Renesas and the Renesas logo are trademarks of Renesas Electronics Corporation. All trademarks and registered trademarks are the property of their respective owners.

Contact Information

For further information on a product, technology, the most up-to-date version of a document, or your nearest sales office, please visit www.renesas.com/contact-us/.