

Azure RTOS sample projects using e² studio or IAR EW

R01AN6455EJ0210
Rev.2.10
2024.7.1

Important Notice:

Notice 1:

On November 21, 2023, Microsoft announced that they have decided to contribute Azure RTOS to Open Source under the stewardship of the Eclipse foundation and Azure RTOS becomes Eclipse ThreadX.

For detailed information, please refer to the announcement titled at Microsoft Contributes Azure RTOS to Open Source.

The support strategy scheme for Eclipse ThreadX will be determined and communicated at a later date.

Microsoft will discontinue the Azure RTOS and Azure RTOS Middleware under the existing agreement [LICENSED-HARDWARE.txt](#).

It's important to note that updates for Azure RTOS on these hardware will no longer be provided.

Notice 2:

Renesas announces to discontinue the existing Sequans-sourced LTE module known as the part number RYZ014A and will no longer be shipping this product.

With the discontinuation of RYZ014A, the CK-RX65N v1 board will also be discontinued. If you are using RYZ014A in a current design or production, the Sequans part numbers, GM01Q is a pin and functionally compatible replacement for RYZ014A.

Below Cellular driver of RX family works the below alternate product combination.

- RYZ014A Cellular Module Control Module : Sequans GM01Q is the compatible module.

Regarding EOL notice of the RYZ014A, please see :

[The link] <https://www.renesas.com/us/en/document/eln/plc-240004-end-life-eol-process-select-part-numbers?r=1503996>

[The product page] <https://www.renesas.com/us/en/products/wireless-connectivity/cellular-iot-modules/ryz014a-lte-cat-m1-cellular-iot-module>

Introduction

Azure RTOS sample projects for each component (ThreadX, FileX, GUIX, NetX Duo, and USBX) can be created using Renesas e² studio or IAR Embedded Workbench (EW) with the on-board emulator. All samples are designed to run on RX family.

This document guides how to create and use these sample projects.

Supported Sample Projects

- **ThreadX sample project**
Contains ThreadX source code
- **Minimal sample project**
Contains ThreadX source code
Simplest sample for ThreadX
- **FileX RAM Disk sample project**
Contains FileX source code
- **NetX Duo Ping sample project**
Contains NetX Duo ping sample project
- **NetX Duo Iperf sample project**
Contains NetX Duo iPerf sample project
- **IoT Embedded SDK sample project**
Sample project to connect to Azure IoT Hub using Azure IoT Middleware for Azure RTOS
- **IoT Embedded SDK PnP sample project (Available up to Azure RTOS v.6.2.1_rel-rx-2.0.0)**
Sample project to connect to Azure IoT Hub using Azure IoT Middleware for Azure RTOS via IoT Plug and Play
- **GUIX 8bpp sample project**
Contains sample for GUIX 8BPP
- **GUIX 16bpp sample project**
Contains sample for GUIX 16BPP
- **GUIX 16bpp draw 2d sample project**
Contains sample for GUIX 16BPP with 2D Draw
- **USBX device CDC-ACM Class sample project**
Contains USBX source code
- **USBX Host Mass Storage Class sample project**
Contains USBX source code
- **USBX Host Communication Device Class (CDC-ACM) sample project**
Contains USBX source code
- **ThreadX Low Power sample project**
Contains ThreadX & low power utility source code
- **Azure Device Update (ADU) sample project**
Sample project for OTA firmware update via Microsoft Azure
- **Secure bootloader sample project**
Used together with ADU sample project to provide a secure boot

Supported Devices

- RX130
- RX140
- RX23E-B
- RX26T

Azure RTOS sample projects using e2 studio or IAR EW

- RX65N
- RX651
- RX660
- RX66T
- RX671
- RX72N

Table 1 Supported Kits

Device	RX65N				RX651	RX130	RX140	RX23E-B	RX26T	RX660	RX66T	RX72N	RX671
	RSK	Cloud Kit	New CK	New CK	RSK RX65N	Target Board	RSK	RSSK	MCB	RSK	RSK	Envision Kit	RSK
Connectivity	Ethernet	Wi-Fi	Ethernet	Cat M1	-	-	-	-	-	-	-	Ethernet	Wi-Fi
ThreadX sample	○	○	○	○	○	○	○	○	○	○	○	○	○
Minimal sample	○	○	○	○	○	○	○	○	○	○	○	○	○
FileX sample	○	○	○	○	○	○	○	○	○	○	○	○	○
Ping sample	○	○	○	-	-	-	-	-	-	-	-	○	○
lperf sample	○	-	○	-	-	-	-	-	-	-	-	○	-
IoT Embedded SDK sample	○	○	○	-	-	-	-	-	-	-	-	○	○
IoT Embedded SDK sample using EWF	-	-	-	○	-	-	-	-	-	-	-	-	-
IoT Embedded SDK PnP sample	○	○	○	-	-	-	-	-	-	-	-	○	○
IoT Embedded SDK PnP sample using EWF	-	-	-	○	-	-	-	-	-	-	-	-	-
GUIX (8bpp, 16bpp, draw 2d) sample	○	-	-	-	-	-	-	-	-	-	-	○	-
USB PCDC sample	○	○	○	○	-	-	-	-	-	-	-	-	-
USB HMSC sample	○	-	○	○	-	-	-	-	-	-	-	○	○
USB HCDC sample	○	-	○	○	-	-	-	-	-	-	-	○	○
ThreadX Low Power sample	○	○	○	○	○	○	○	○	-	○	-	○	○
ADU sample	○	○	○	-	-	-	-	-	-	-	-	○	○
Bootloader sample	○	○	○	-	-	-	-	-	-	-	-	○	○

Supported sample projects are different by each device. For details, please refer to the following URL.

<https://github.com/renesas/azure-rtos>

Download Links for Development Environment

- e² studio : 2024-04 or later

<https://www.renesas.com/software-tool/e-studio>

- Renesas C/C++ Compiler for RX Family CC-RX : V3.06.00 or later

<https://www.renesas.com/software-tool/cc-compiler-package-rx-family>

- GCC for Renesas RX : 8.3.0.202311 or later

<https://gcc-renesas.com/rx-download-toolchains/>

- IAR Embedded Workbench for RX : 4.20.1 or later

<https://www.iar.com/products/architectures/renesas/iar-embedded-workbench-for-renesas-rx/>

- RX Smart Configurator : V2.21.0 and later

<https://www.renesas.com/software-tool/smart-configurator>

- Azure IoT Explorer

<https://github.com/azure/azure-iot-explorer/releases>

Contents

1. Getting Started	5
1.1 Creating project using e ² studio	5
1.2 Creating project using IAR EW.....	7
2. Sample Project Descriptions.....	8
2.1 ThreadX sample project	8
2.2 Minimal sample project.....	10
2.3 FileX RAM Disk sample project.....	12
2.4 NetX Duo Ping sample project	14
2.5 NetX Duo lperf sample project	16
2.6 IoT Embedded SDK sample project.....	18
2.7 IoT Embedded SDK PnP sample project	24
2.8 GUIX 8bpp/16bpp/16bpp_draw2d sample project.....	26
2.9 USBX device CDC-ACM Class sample project.....	28
2.10 USBX Host Mass Storage Class sample project	30
2.11 USBX Host Communication Device Class (CDC-ACM) sample project.....	33
2.12 ThreadX Low Power sample project	35
2.12.1 Overview of sample project.....	35
2.12.2 Execute sample project.....	36
2.12.3 Configuration of ThreadX Low Power by Smart Configurator.....	38
2.13 Azure Device Update (ADU) sample project.....	40
Revision History.....	41

1. Getting Started

To create new Azure RTOS project, the procedure is different between e² studio and IAR EW.

1.1 Creating project using e² studio

1. Launch e² studio, create new project: [File] > [New] > [Renesas C/C++ Project] and select **Renesas RX** and create a new workspace.

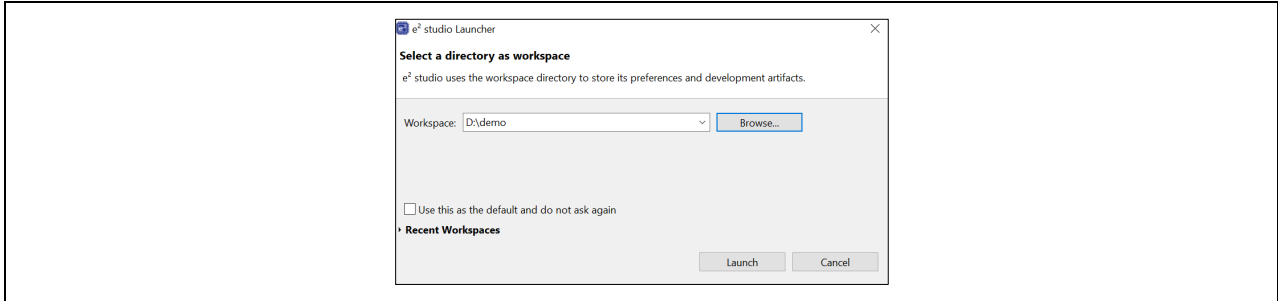

Figure 1.1 Workspace Creation Window

2. Select **GCC for Renesas RX C/C++ Executable Project** or **Renesas CC-RX C/C++ Executable Project**.

Note : For those who use CC-RX Evaluation Edition. After the trial period, the CC-RX features become limited to restrictions on the linkage size. RX Azure RTOS sample will exceed this restriction. Consider updating CC-RX Professional edition or using GCC for Renesas RX C/C++ Executable.

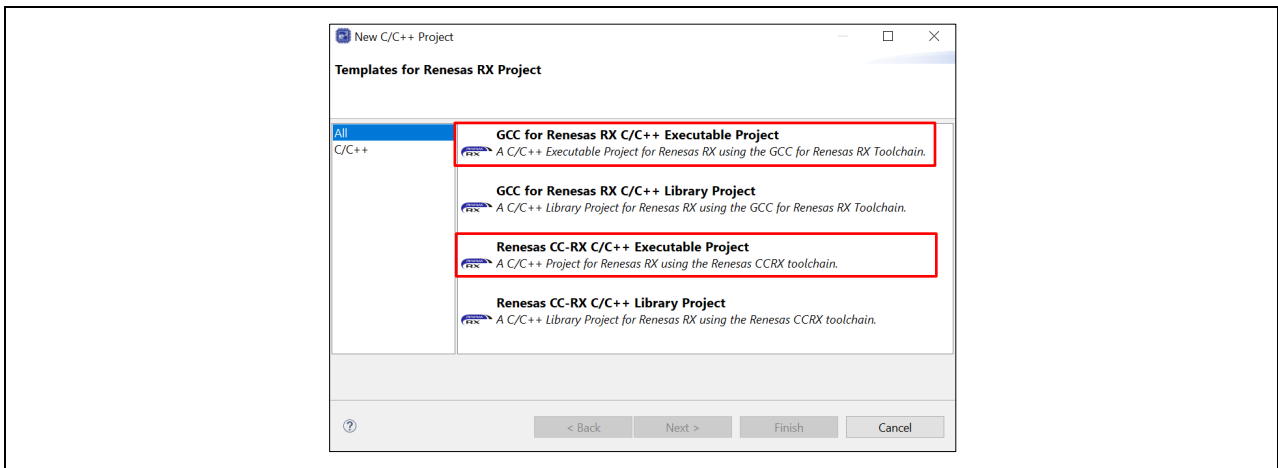

Figure 1.2 Toolchain Setting Window

3. Input the project name.
4. Click [Next].

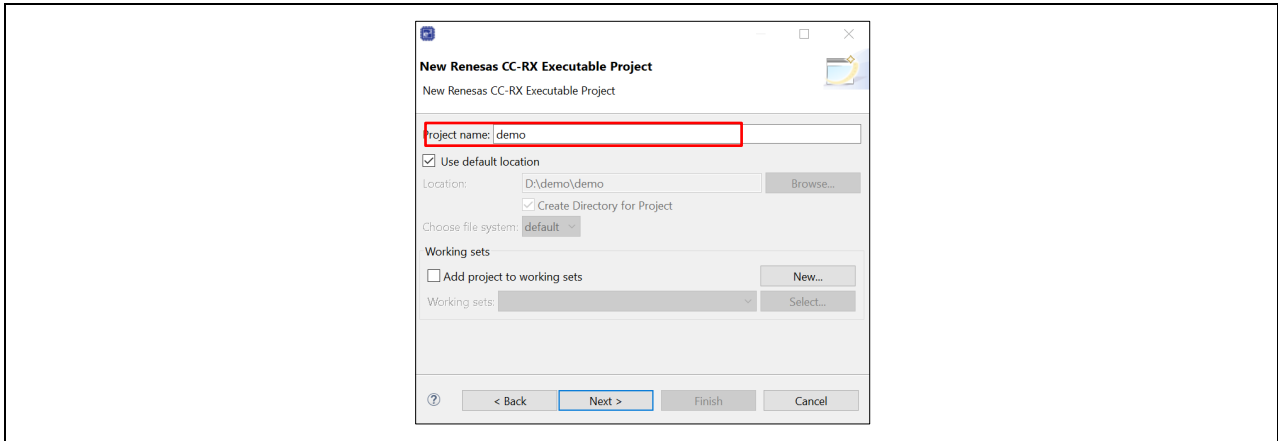

Figure 1.3 Project Creation Window

5. At **RTOS**, select “**Azure RTOS**”.
6. Click **Manage RTOS Versions...** to download software package.
7. At **RTOS Version**, select a version that downloaded at step 6.
8. At Target Board, select a board that you are working on. Configurations are automatically set based on the target board.
9. Click [**Next**].

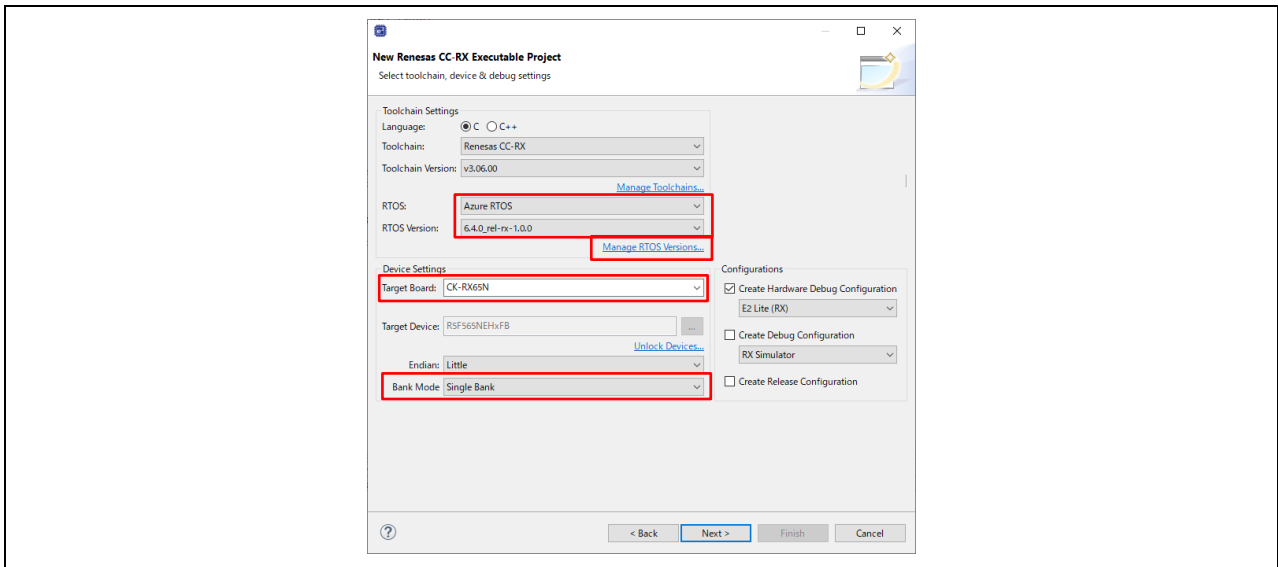

Figure 1.4 RTOS and Target Board Setting Window

10. Click [**Next**].

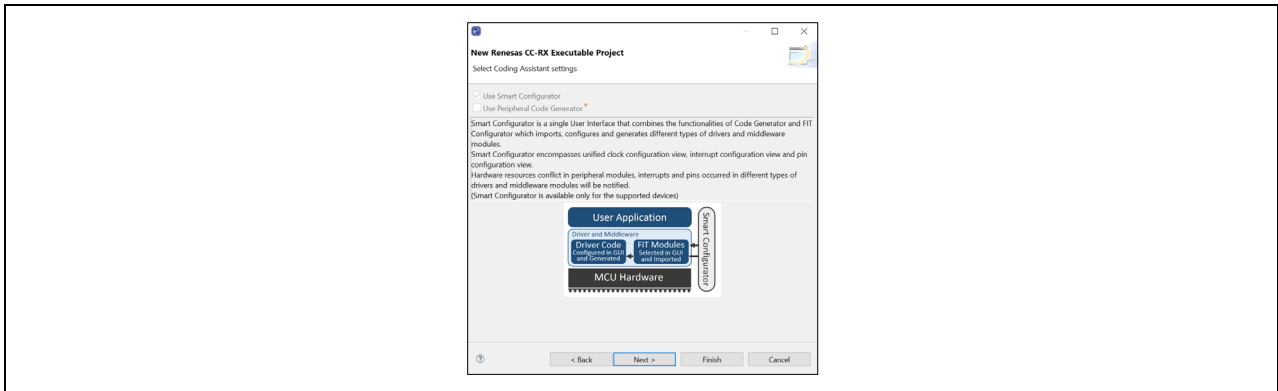

Figure 1.5 Coding Assistant Setting Window

Azure RTOS sample projects using e2 studio or IAR EW

- 11. Select an application.
- 12. Click [Finish].

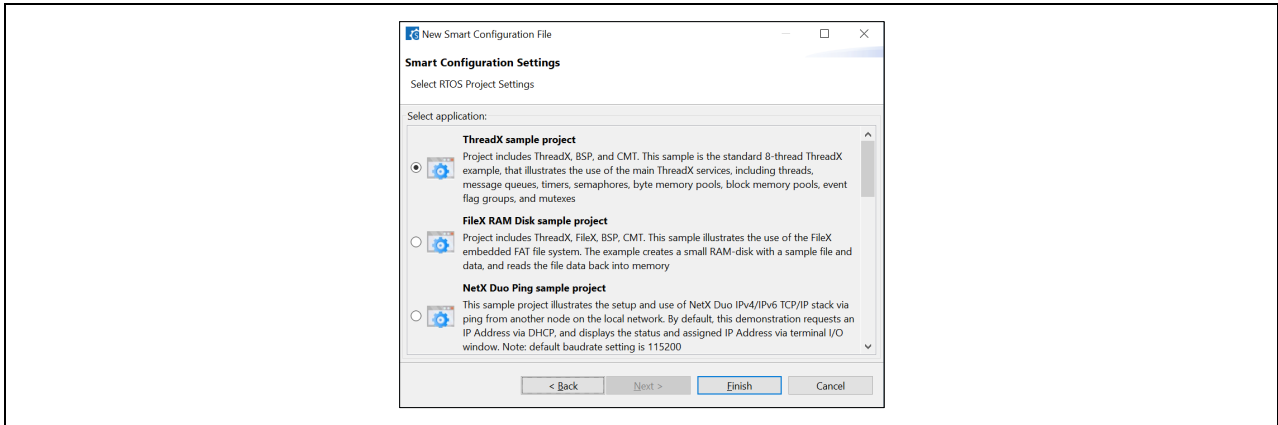

Figure 1.6 Select Application Window

- 13. Azure RTOS sample project including each component is created.

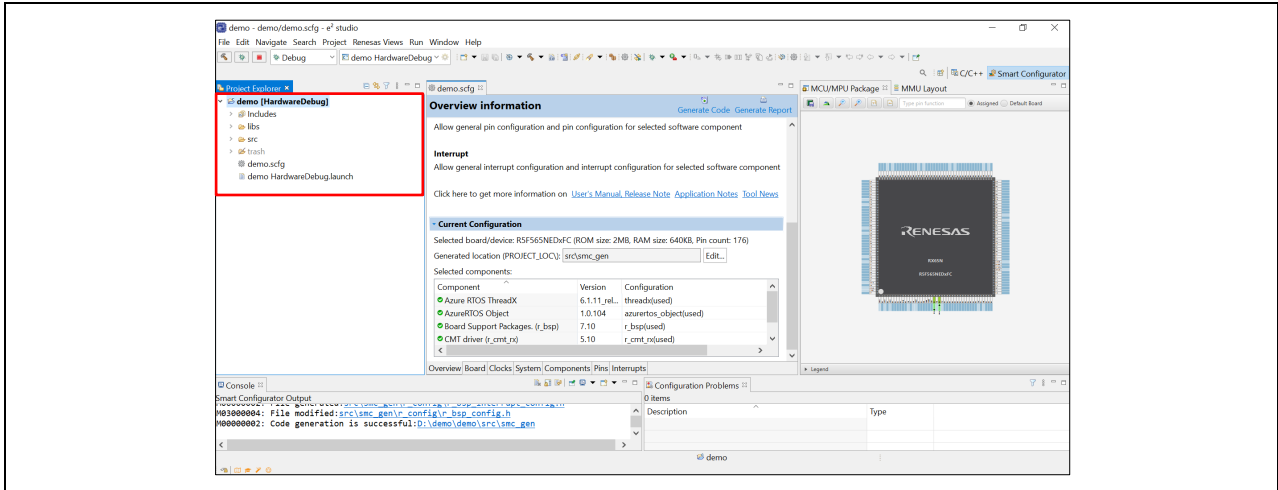

Figure 1.7 Created Sample Project Window

- 14. Build project: Select the sample project in the e2 studio workspace and right click and select build to build the sample project.
- 15. Make sure that target board is set to Debug mode in Jumper Settings. For the detail, see each board User manual.
- 16. Select Download and Debug to download and start execution of the project. By default, execution stops at a breakpoint set at main.

Note: Other debugger settings may be required depending on the board type you specify.

In the case of Renesas Starter Kit+ for RX65N-2MB: click **Debugger > Connection Settings > Power Target From The Emulator**, and set **No**.

- 17. Please review the sample descriptions later in this guide for additional setup and expected behavior.

1.2 Creating project using IAR EW

Please refer to following FAQ for the detailed instructions:

- English : <https://en-support.renesas.com/knowledgeBase/20533128>
- Japanese : <https://ja-support.renesas.com/knowledgeBase/20533124>

2. Sample Project Descriptions

Additional setup and expected behavior of each sample project are described in this section.

2.1 ThreadX sample project

This sample is the standard 8-thread ThreadX example, that illustrates the use of the main ThreadX services, including threads, message queues, timers, semaphores, byte memory pools, block memory pools, event flag groups, and mutexes.

Supported Kits :

- Target Board for RX130
- Renesas Starter Kit for RX140
- Renesas Solution Starter Kit for RX23E-B
- MCB-RX26T Type A/B/C
- Renesas Starter Kit+ for RX65N-2MB
- CK-RX65N cloud kit
- Renesas RX65N Cloud Kit
- Renesas Starter Kit for RX660
- Renesas Starter Kit for RX66T
- Renesas Starter Kit+ for RX671
- RX72N Envision Kit

To run this sample, simply follow these steps (assuming the steps described in the previous section were done):

1. Set a breakpoint at any line.
2. Select **Go** to start execution of the sample project.

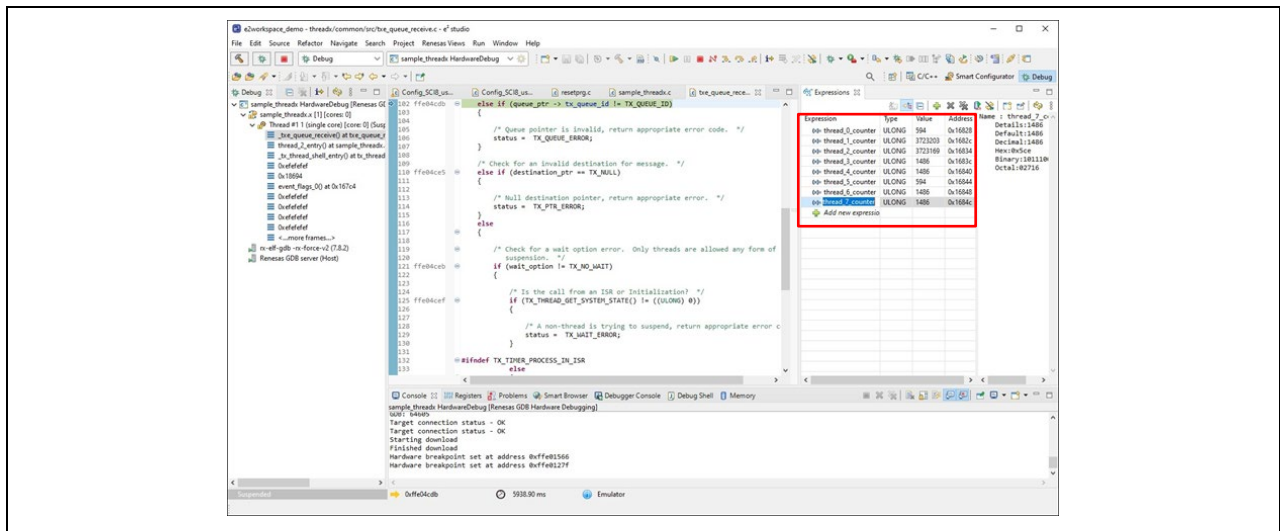

Figure 2.1 e2 studio Debugger Screen

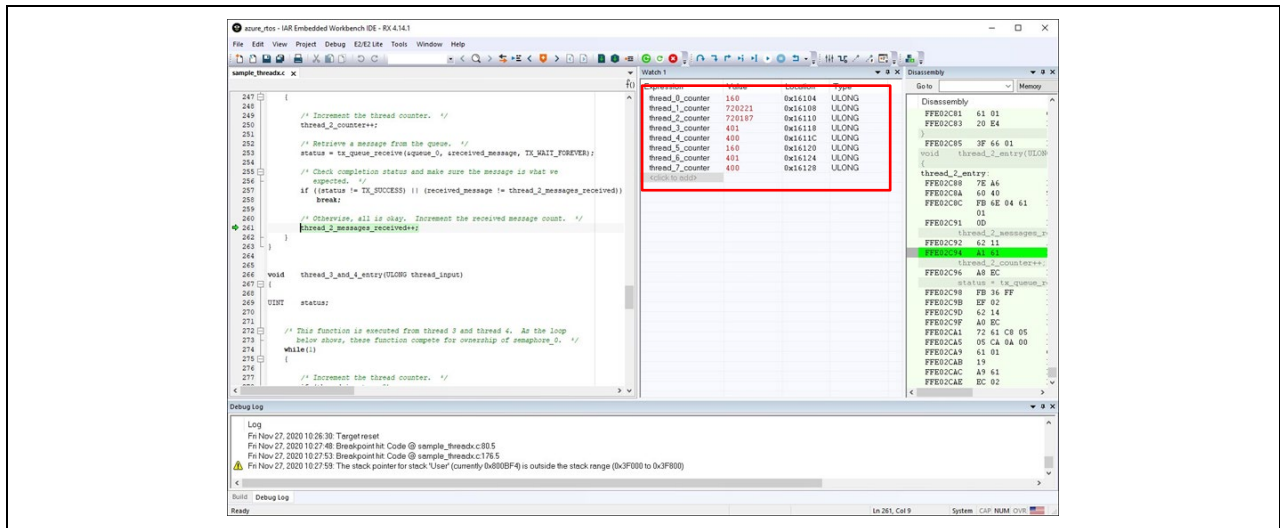

Figure 2.2 IAR EW Debugger Screen

After hitting **Break**, the debugger screen shot above shows various counters incremented by the ThreadX sample as each of the main components of the ThreadX are exercised.

To learn more about Azure RTOS ThreadX, view <https://docs.microsoft.com/azure/rtos/threadx/>.

2.2 Minimal sample project

This is minimal sample with one thread. It illustrates the usage of main ThreadX service. The sample outputs the message to serial terminal and blinks LED every second.

Supported Kits:

- Target Board for RX130
- Renesas Starter Kit for RX140
- Renesas Solution Starter Kit for RX23E-B
- MCB-RX26T Type A/B/C
- Renesas Starter Kit+ for RX65N-2MB
- CK-RX65N cloud kit
- Renesas RX65N Cloud Kit
- Renesas Starter Kit for RX660
- Renesas Starter Kit for RX66T
- Renesas Starter Kit+ for RX671
- RX72N Envision Kit

To run this sample, simply follow these steps (assuming the steps described in the previous section were done):

[For RX130 Target Board and MCB RX26T]

1. Select **Go** to start execution of the sample project
2. Open “Renesas Debug Virtual Console” .

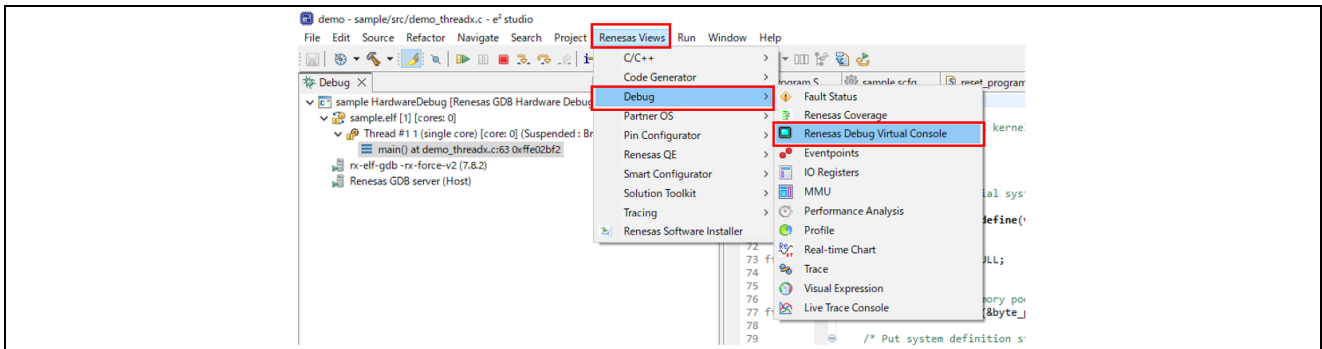

Figure 2.3 Renesas Debug Virtual Console

Azure RTOS sample projects using e2 studio or IAR EW

- As the project runs, it will output “Hello, RX AzureRTOS sample” to serial terminal per one second, and it will blink an LED on the board per one second.

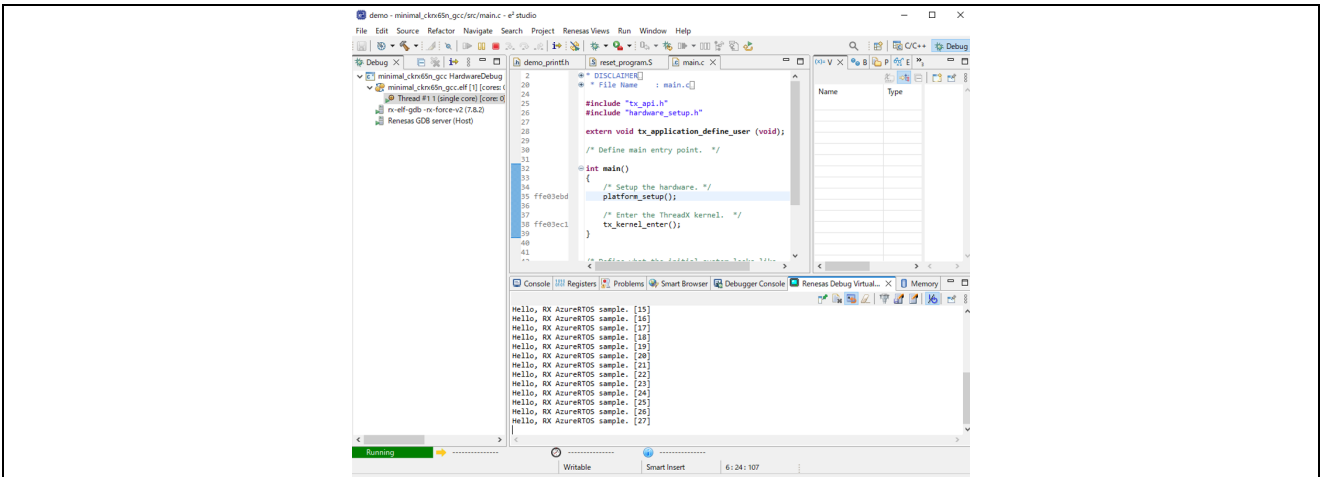

Figure 2.4 Minimal sample output

[For target boards except for RX130 Target Board and MCB RX26T]

- Verify the serial port in your OS's device manager. It should show up as a COM port

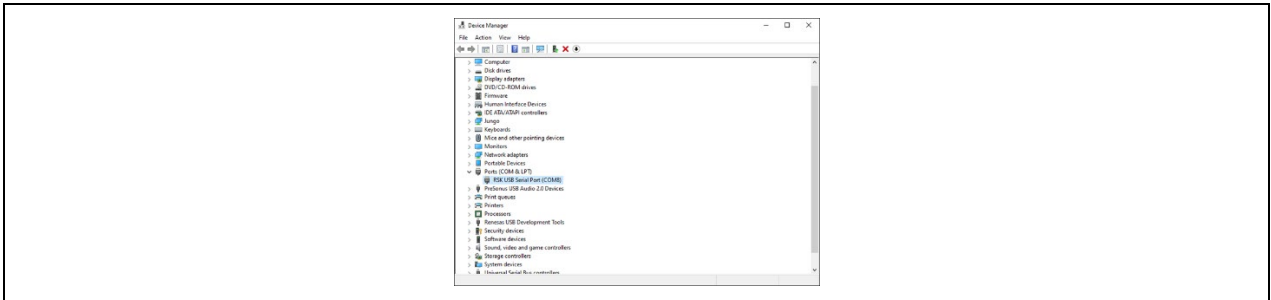

Figure 2.5 Device Manager

- Open your favorite serial terminal program such as Putty and connect to the COM port discovered above. Configure the following values for the serial port:

Baud rate: **115200**

Data bits: **8**

Parity: **none**

Stop bits: **1**

Flow control: **none**

- Select **Go** to start execution of the sample project
- As the project runs, it will output “Hello, RX AzureRTOS sample” to serial terminal per one second, and it will blink an LED on the board per one second.

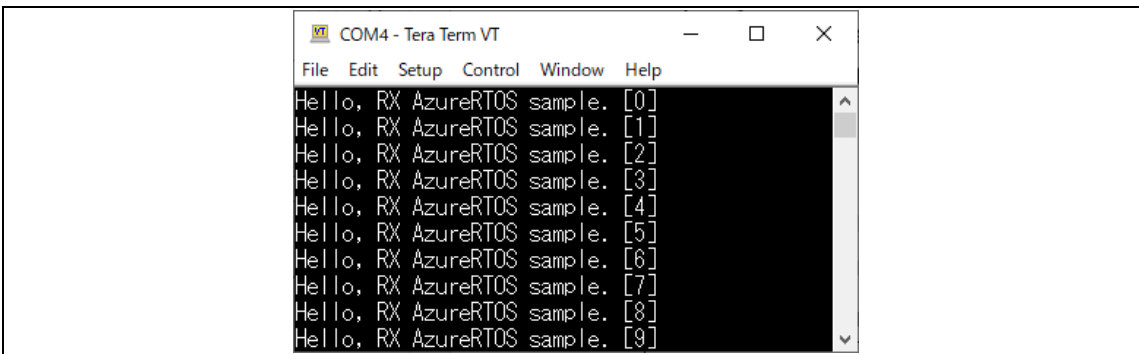

Figure 2.6 Minimal sample output

Table 2 Assigned LED on the board

Board	LED
CK-RX65N	LED4
RX65N Cloud Kit	LED1
RSK RX65N-2M	LED0
RSK RX671	LED2
RX72N Envision Kit	LED2
RX130 Target Board	LED0
RSK RX140	LED0
RX660-Starter-Kit	LED0
RX66T-Starter-Kit	LED0
MCB RX26T	LED1
RSSK RX23E-B	LED1

2.3 FileX RAM Disk sample project

This sample illustrates the use of the FileX embedded FAT file system. The example creates a small RAM-disk with a sample file and data, and reads the file data back into memory. The debugger can show the data being read.

Supported Kits:

- Target Board for RX130
- Renesas Starter Kit for RX140
- Renesas Solution Starter Kit for RX23E-B
- MCB-RX26T Type A/B/C
- Renesas Starter Kit+ for RX65N-2MB
- CK-RX65N cloud kit
- Renesas RX65N Cloud Kit
- Renesas Starter Kit for RX660
- Renesas Starter Kit for RX66T
- Renesas Starter Kit+ for RX671
- RX72N Envision Kit

To run this sample, simply follow these steps (assuming the workspace is already open):

1. Open **sample_filex_ram_disk.c** and set a breakpoint around Line 201 at `if (status != FX_SUCCESS)`
2. Select **Go** to start execution of the sample project
3. In the **Expression** window for e² studio or **Watch** window for IAR EW, ensure you watch the **local_buffer** variable as expression.

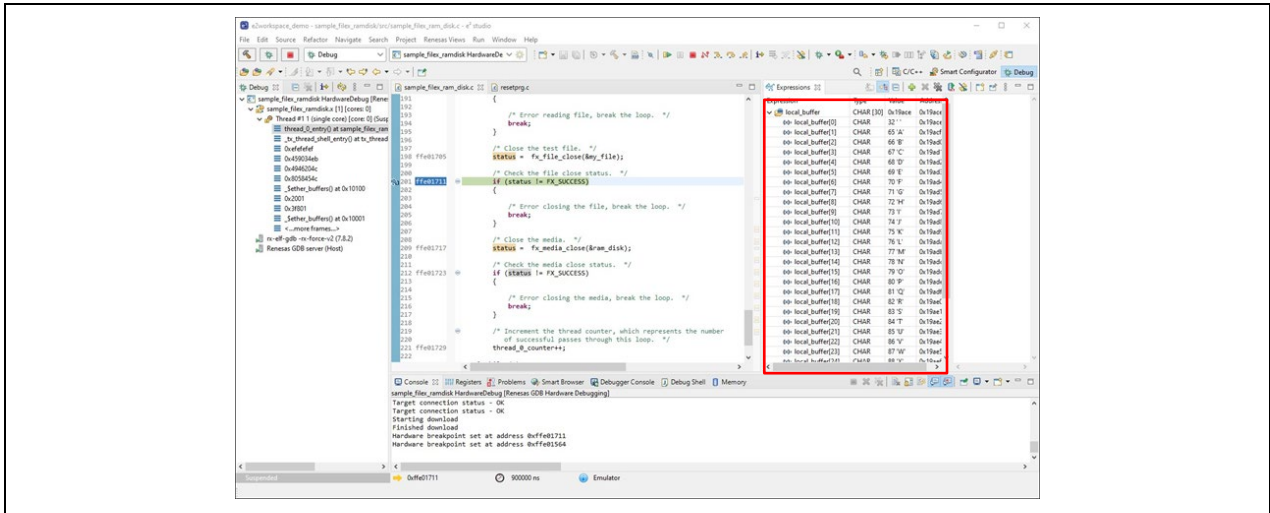

Figure 2.7 e² studio Debugger Screen

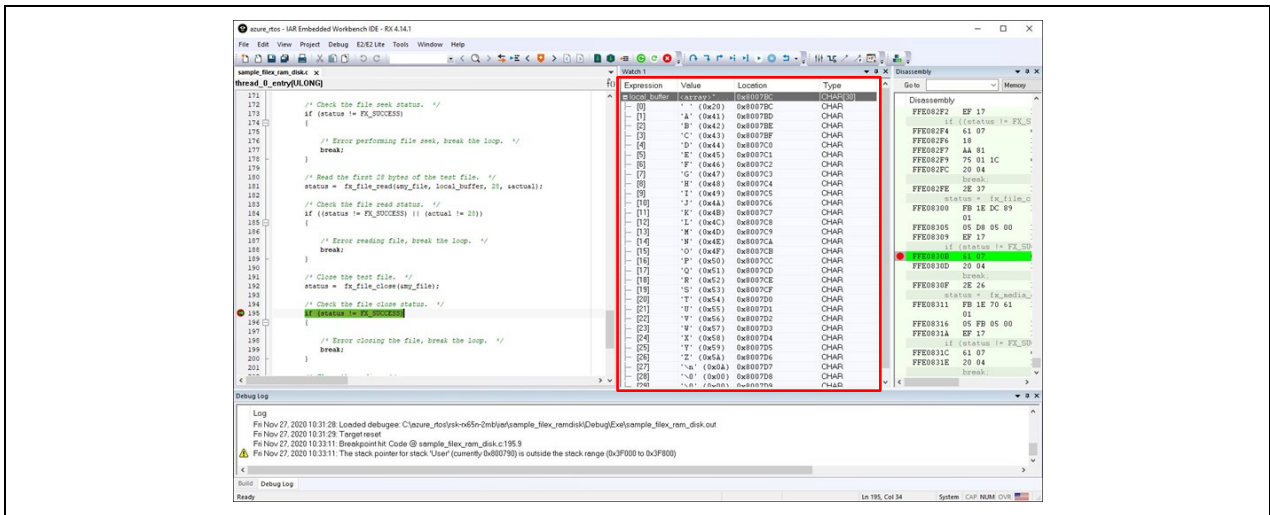

Figure 2.8 IAR EW Debugger Screen

The debugger screen shot above shows the file data read back in the RAM disk sample.

To learn more about Azure RTOS FileX, view <https://docs.microsoft.com/azure/rtos/filex/>.

2.4 NetX Duo Ping sample project

This sample project illustrates the setup and use of NetX Duo IPv4/IPv6 TCP/IP stack via ping from another node on the local network. By default, this demonstration requests an IP Address via DHCP, and displays the status and assigned IP Address via Terminal program.

Supported Kits:

- Renesas Starter Kit+ for RX65N-2MB
- CK-RX65N cloud kit (Ether)
- Renesas RX65N Cloud Kit
- Renesas Starter Kit+ for RX671
- RX72N Envision Kit

To run this sample project, simply follow these steps (assuming the workspace is already open):

5. Verify the serial port in your OS's device manager. It should show up as a COM port

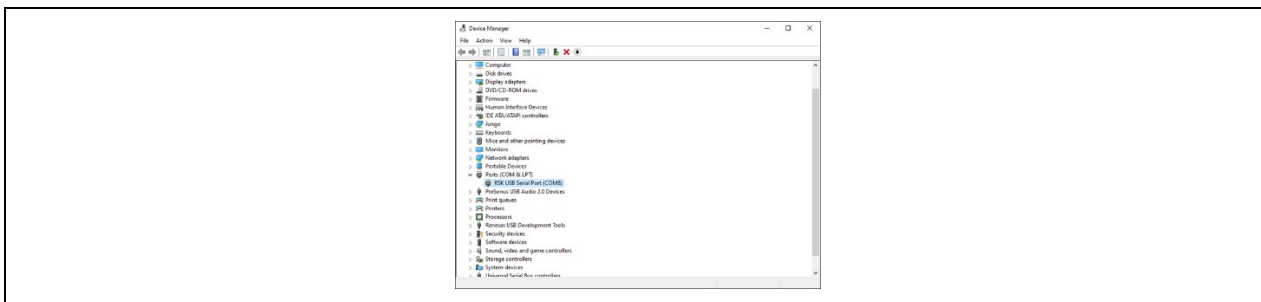

Figure 2.9 Device Manager

6. Open your favorite serial terminal program such as Putty and connect to the COM port discovered above. Configure the following values for the serial port:

Baud rate: **115200**
Data bits: **8**
Parity: **none**
Stop bits: **1**
Flow control: **none**

7. Select **Go** to start execution of the sample project
8. As the project runs you should observe the IP address assigned via DHCP in the output window



Figure 2.10 IP Address Assigned via DHCP

9. The example above shows that the assigned IP address of the RX MCU is 192.168.2.115. When the demonstration is running it can be pinged by any machine on the network. The following is an example of a ping from a Windows machine on the same local network (using the DOS command window).

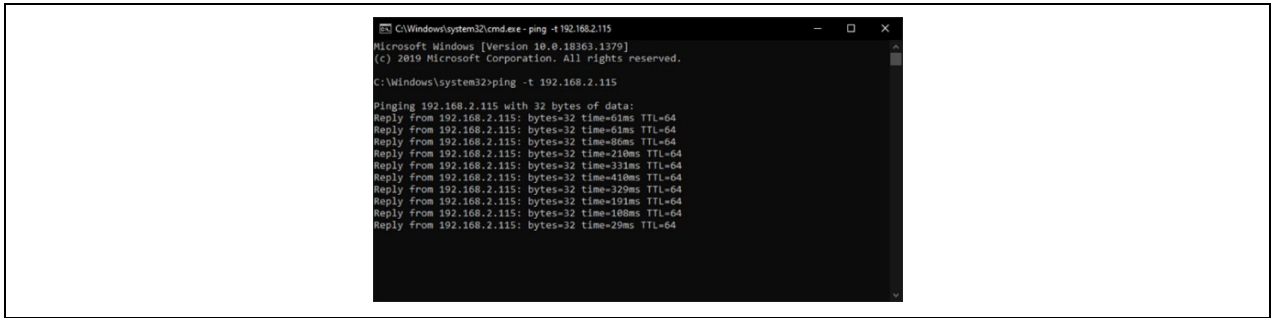

Figure 2.11 Ping Response

To learn more about Azure RTOS NetX Duo, view <https://docs.microsoft.com/azure/rtos/netx/>.

2.5 NetX Duo Iperf sample project

This demonstration illustrates TCP and UDP network throughput, using NetX Duo IPv4/IPv6 TCP/IP stack, and the industry-standard Iperf network throughput benchmark, with Jperf GUI. By default, this demonstration requests an IP Address via DHCP, and displays the status and assigned IP Address via Terminal program.

Supported Kits:

- Renesas Starter Kit+ for RX65N-2MB
- CK-RX65N cloud kit (Ether)
- Renesas Starter Kit+ for RX671
- RX72N Envision Kit

To run the NetX Duo Iperf Sample project, simply follow these steps (assuming the workspace is already open):

Note: This sample is Ethernet based and therefore assumes an Ethernet cable is connected to the Ethernet connector on the board.

1. Verify the serial port in your OS's device manager. It should show up as a COM port.

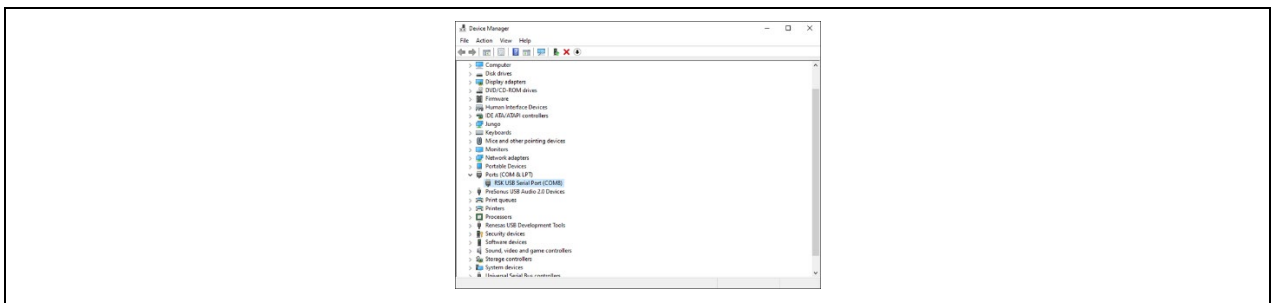

Figure 2.12 Device Manager

2. Open your favorite serial terminal program such as PuTTY and connect to the COM port discovered above. Configure the following values for the serial port:

Baud rate: **115200**

Data bits: **8**

Parity: **none**

Stop bits: **1**

Flow control: **none**

3. Select **Go** to start execution of the sample project.
4. As the project runs you should observe the IP address assigned via DHCP in the output window.

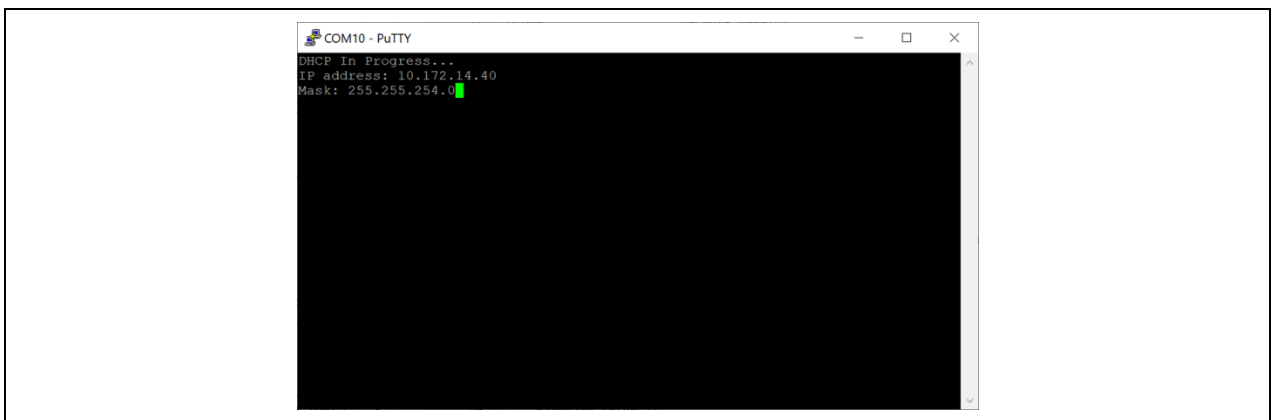

Figure 2.13 IP address assigned via DHCP

5. Once running, simply browse to target IP address (in the screen shot above it is 10.172.14.40) to view the NetX Duo Iperf server page, which provides options for running each Iperf test as well as displays the results of each test. Here is as sample view after browsing 10.172.14.40:

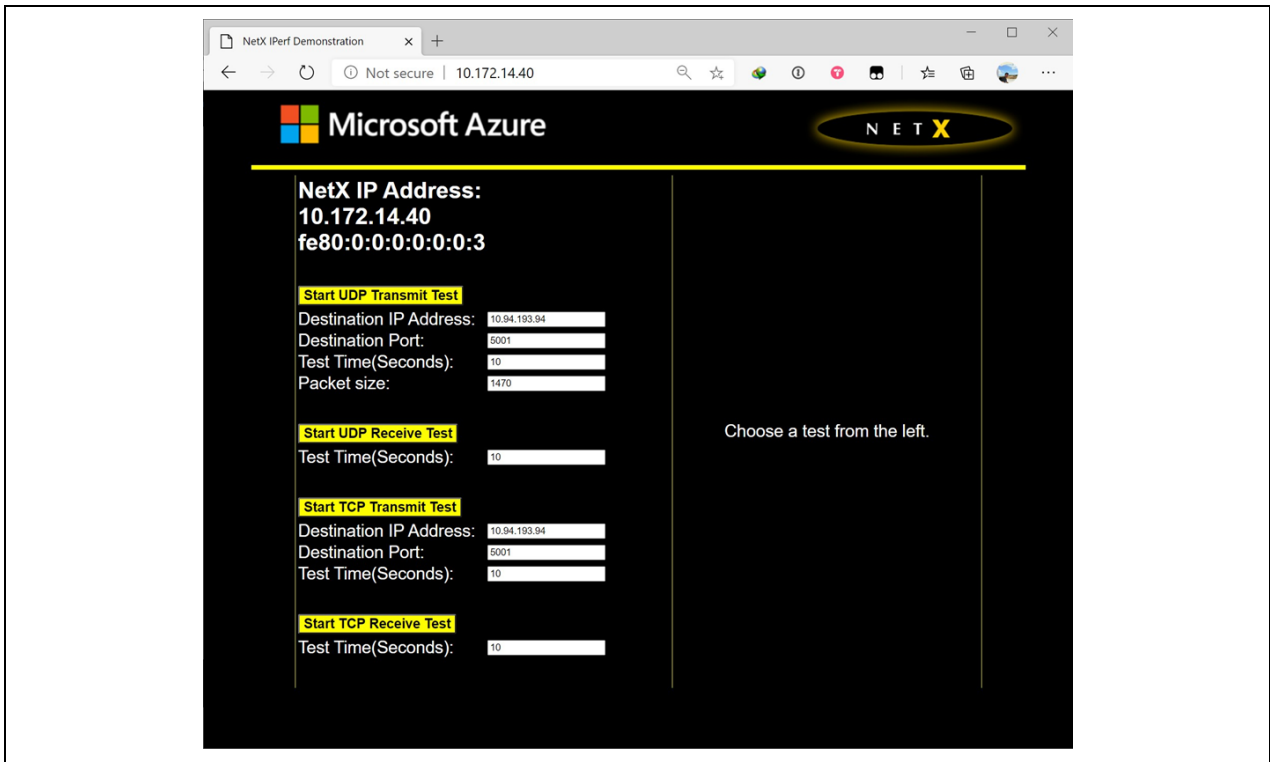

Figure 2.14 NetX Duo Iperf Server Page

Note: Static IP address assignment is also possible by disabling `NX_ENABLE_DHCP` in the project settings and modifying the default static IP address of 192.168.1.211 in the source file "sample_netx_duo_iperf.c" file. To learn more about Azure RTOS NetX Duo, view <https://docs.microsoft.com/azure/rtos/netx/>.

2.6 IoT Embedded SDK sample project

This demonstration connects to Azure IoT Hub using Azure IoT middleware for Azure RTOS. This demonstration also publishes the message to IoT Hub every few seconds.

Supported Kits:

- Renesas Starter Kit+ for RX65N-2MB
- CK-RX65N cloud kit (Ether/ Cellular)
- Renesas RX65N Cloud Kit
- Renesas Starter Kit+ for RX671
- RX72N Envision Kit

It is also possible to view device properties, view device telemetry, update device twin, call a direct method on device and send cloud-to-device message using Azure IoT Explorer.

Following videos guide how to set up and run this Azure RTOS sample project in detail. This video uses CK-RX65N to introduce, but the setup follow is common to every board.

[Azure RTOS Tutorial \(1/3\) CK-RX65N](#)

[Azure RTOS Tutorial \(2/3\) CK-RX65N: Program Build](#)

[Azure RTOS Tutorial \(3/3\) CK-RX65N: Cloud Operation](#)

Projects with cellular connectivity have “**with EWF**” at the end of the project name on **Select Application Window**.

1. Prepare Azure resources such as creating an IoT Hub and registering an IoT device by referring Microsoft document.
For details, please refer to the [Application Note \(RX65N Group: Visualization of Sensor Data using RX65N Cloud Kit and Azure RTOS\)](#), specifically chapters 3.1.
2. Confirm that you have the copied the following values to use in the next step.
 - **hostname**
 - **deviceId**
 - **primaryKey**
3. Open **sample_config.h** to set the Azure IoT device information constants to the values that you saved in step 2.

Constant name	Value
HOST_NAME	{Your IoT hub hostName value}
DEVICE_ID	{Your deviceId value}
DEVICE_SYMMETRIC_KEY	{Your primaryKey value}

4. **[Wi-Fi]** Open **main.c** to set the Wi-Fi network parameters when you use the boards of which connectivity is Wi-Fi.

Constant name	Value
WIFI_SSID	{Your Wi-Fi SSID value}
WIFI_PASSWORD	{Your Wi-Fi password}

5. **[Cellular]** Open **scfg file in your project** and choose components on the tab. Then click **ewf** in components on the left side and **set** your **SIM APN** in “The SIM operator APN”.

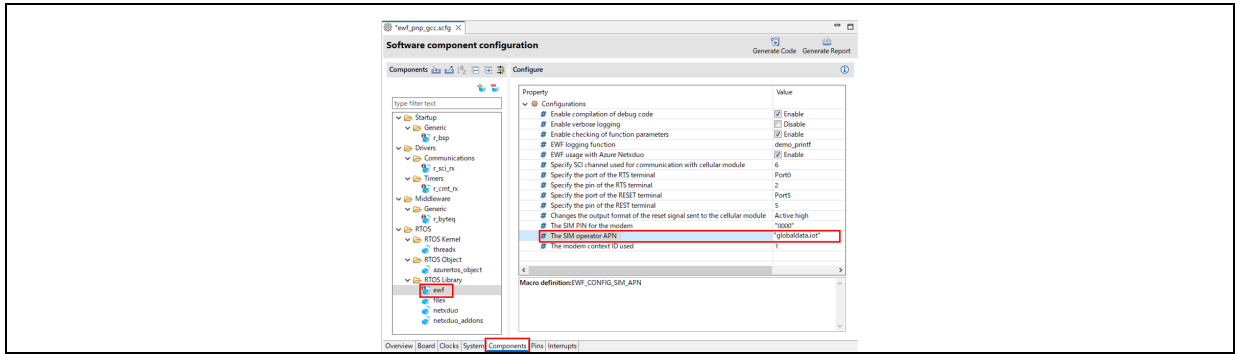

6. **[Ethernet]** You don't need to set specific parameters when you use the boards of which connectivity is ethernet.
7. Verify the serial port in your OS's device manager. It should show up as a COM port.

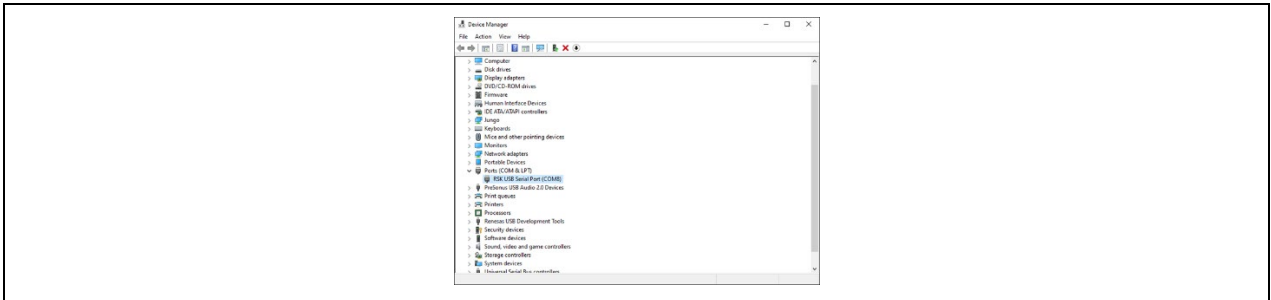

Figure 2.15 Device Manager

8. Open your favorite serial terminal program such as Putty and connect to the COM port discovered above. Configure the following values for the serial port:
 Baud rate: **115200**
 Data bits: **8**
 Parity: **none**
 Stop bits: **1**
 Flow control: **none**
9. Build project
10. Select **Download and Debug** to download and start execution of the project
11. As the project runs, the demo prints out status information to the terminal output window. The demo also publishes the telemetry message to IoT Hub every few seconds. Check the terminal output to verify that messages have been successfully sent to the Azure IoT hub.

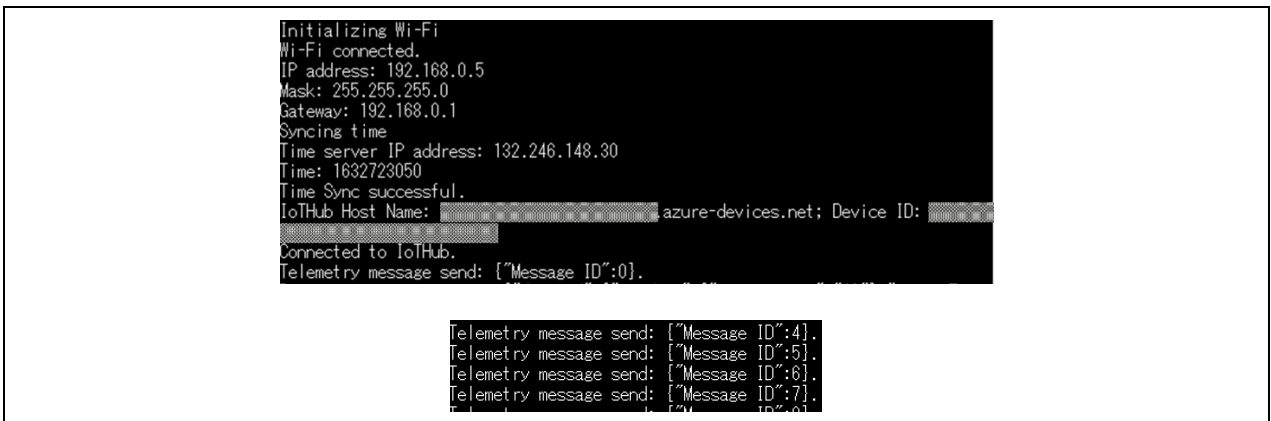

Figure 2.16 Status Information and Telemetry Message

Azure RTOS sample projects using e2 studio or IAR EW

You can use the **Azure IoT Explorer** to view and manage the properties of your devices. In the following steps, you'll add a connection to your IoT hub in IoT Explorer.

1. Download and install latest (above v0.14.5) Azure IoT Explorer from: <https://github.com/Azure/azure-iot-explorer/releases>
2. Copy the connection string: **Microsoft Azure Portal** > **sign in** > select your IoT Hub > **[Share access policies]** > **[iothubowner]** > **[Primary connection string]**.

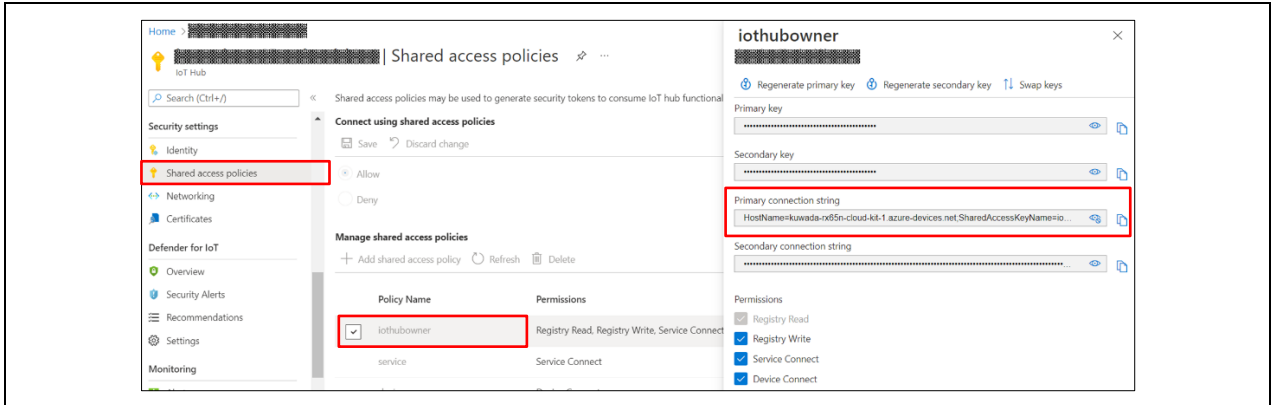

Figure 2.17 Primary Connection String

3. In Azure IoT Explorer, select **IoT hubs** > **Add connection**.
4. Paste the connection string into the **Connection string** box.
5. Select **Save**.

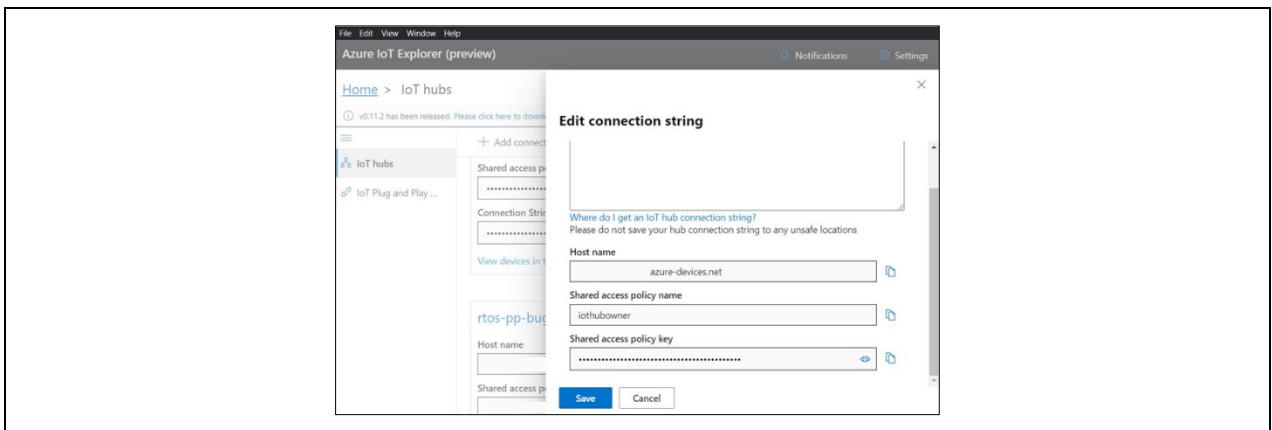

Figure 2.18 Azure IoT Explorer

6. If the connection succeeds, the Azure IoT Explorer switches to a Devices view and lists your device.

To view device properties using Azure IoT Explorer:

1. Select the link for your device identity. IoT Explorer displays details for the device.
2. Inspect the properties for your device in the **Device identity** panel.

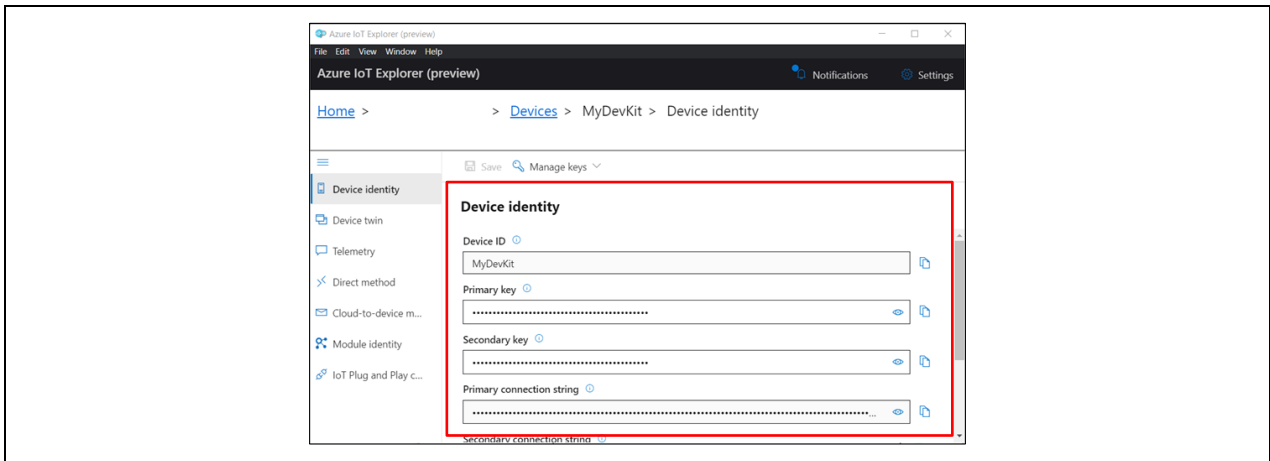

Figure 2.19 Azure IoT Explorer

To view device telemetry using Azure IoT Explorer:

1. In IoT Explorer select **Telemetry**. Confirm that **Use built-in event hub** is set to Yes.
2. Select **Start**.
3. View the telemetry as the device sends messages to the cloud.

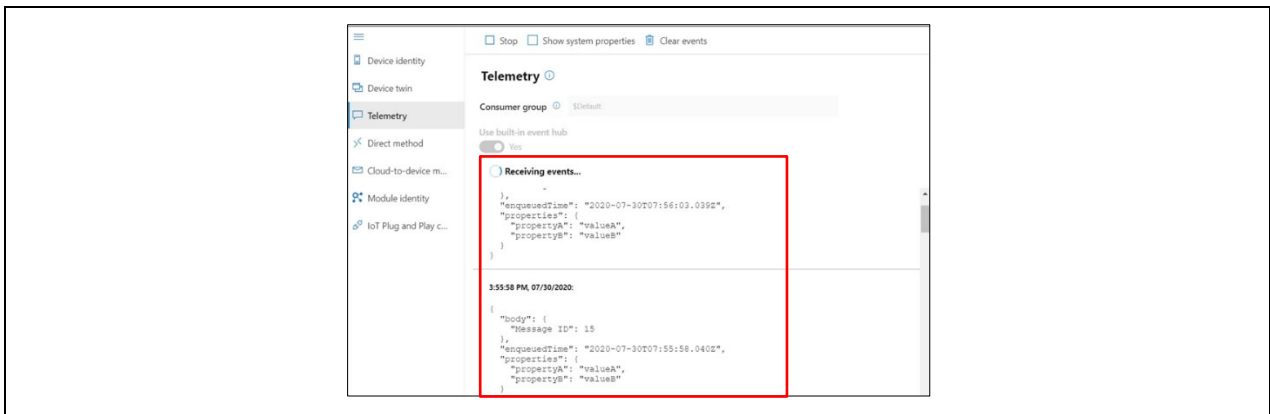

Figure 2.20 Telemetry Message

To update device twin using Azure IoT Explorer:

1. In IoT Explorer select **Device twin**.
2. Modify the **desired** section of the Device twin, you can add a custom twin:

```
"weather": {
    "temperature": "25"
},
```

3. Select **Save**.

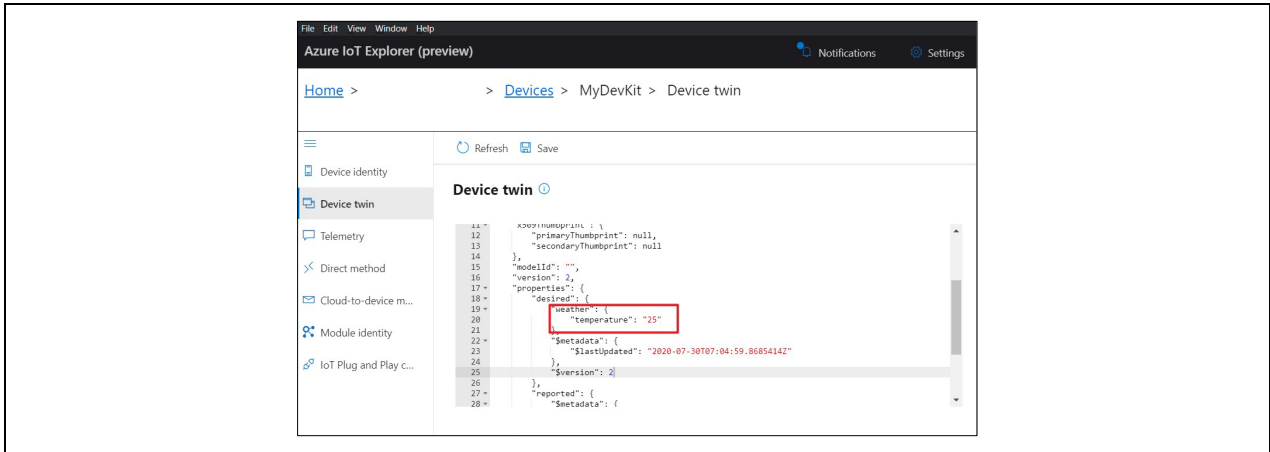

Figure 2.21 Device Twin

4. View the notification for the device twin update status.
5. In the terminal output window, you can view the desired device twin properties are received.

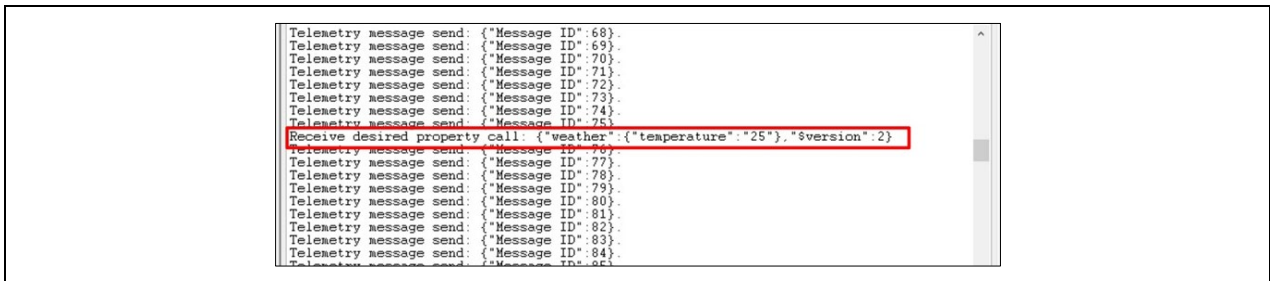

Figure 2.22 Received Desired Device Twin Properties

To call a direct method on device using Azure IoT Explorer:

You can also use Azure IoT Explorer to call a direct method that you have implemented on your device. Direct methods have a name, and can optionally have a JSON payload, configurable connection, and method timeout. To call a direct method in Azure IoT Explorer:

1. In IoT Explorer select **Direct method**.
2. Send a direct method to mimic the device reboot with payload. The device will receive and output the payload as dummy data.

- Method name: reboot
- Payload: {"timeout": 500}

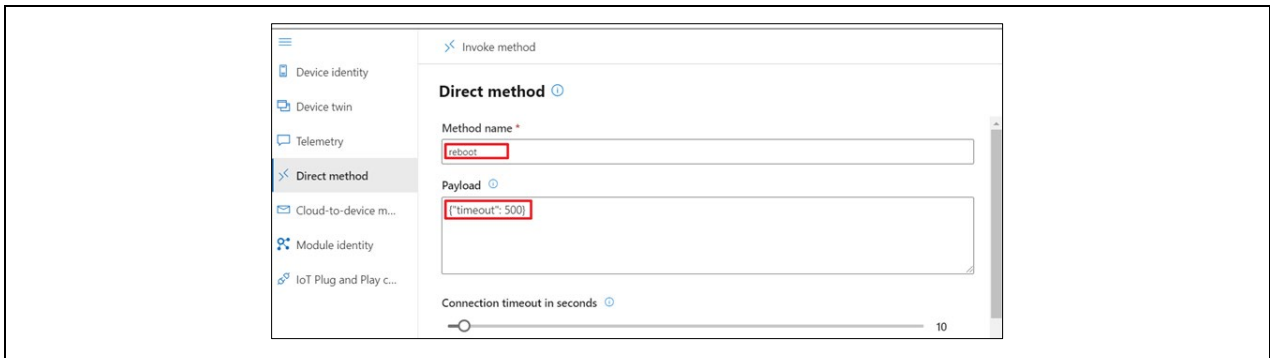
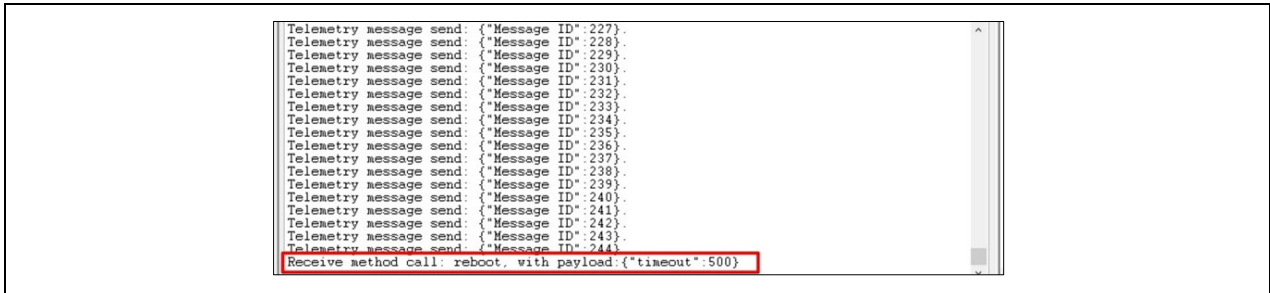

Figure 2.23 Direct Method

Azure RTOS sample projects using e2 studio or IAR EW

3. Select **Invoke method**.
4. In the terminal output window, you can view the method is invoked on the IoT Device.



```
Telemetry message send: {"Message ID": 227}.
Telemetry message send: {"Message ID": 228}.
Telemetry message send: {"Message ID": 229}.
Telemetry message send: {"Message ID": 230}.
Telemetry message send: {"Message ID": 231}.
Telemetry message send: {"Message ID": 232}.
Telemetry message send: {"Message ID": 233}.
Telemetry message send: {"Message ID": 234}.
Telemetry message send: {"Message ID": 235}.
Telemetry message send: {"Message ID": 236}.
Telemetry message send: {"Message ID": 237}.
Telemetry message send: {"Message ID": 238}.
Telemetry message send: {"Message ID": 239}.
Telemetry message send: {"Message ID": 240}.
Telemetry message send: {"Message ID": 241}.
Telemetry message send: {"Message ID": 242}.
Telemetry message send: {"Message ID": 243}.
Telemetry message send: {"Message ID": 244}.
Receive method call: reboot, with payload: {"timeout": 500}
```

Figure 2.24 Invoked Method

To send cloud-to-device message using Azure IoT Explorer:

1. In IoT Explorer select **Cloud-to-device message**.
2. Enter the message in the Message body:

```
{ "Hello": "Azure RTOS" }
```

3. Check **Add timestamp to message body**.

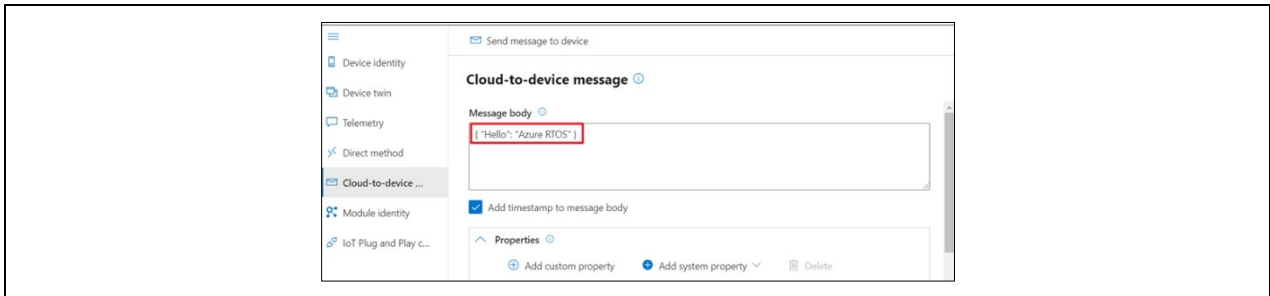
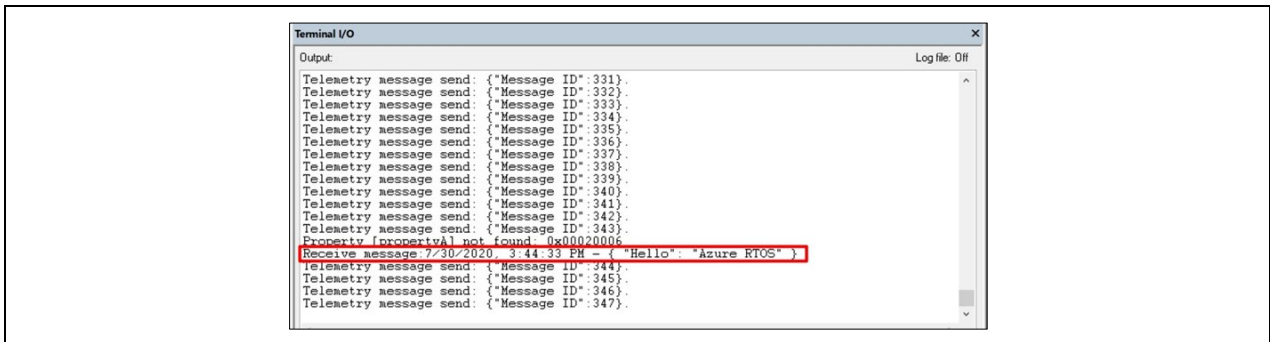

Figure 2.25 Cloud-to-device message

4. Select **Send message to device**.
5. In the terminal output window, you can view the message is received by the IoT Device.



```
Terminal I/O
Output:
Telemetry message send: {"Message ID": 331}.
Telemetry message send: {"Message ID": 332}.
Telemetry message send: {"Message ID": 333}.
Telemetry message send: {"Message ID": 334}.
Telemetry message send: {"Message ID": 335}.
Telemetry message send: {"Message ID": 336}.
Telemetry message send: {"Message ID": 337}.
Telemetry message send: {"Message ID": 338}.
Telemetry message send: {"Message ID": 339}.
Telemetry message send: {"Message ID": 340}.
Telemetry message send: {"Message ID": 341}.
Telemetry message send: {"Message ID": 342}.
Telemetry message send: {"Message ID": 343}.
Property [property] not found: 0x00020006
Receive message: 7/30/2020, 3:44:33 PM - {"Hello": "Azure RTOS"}
Telemetry message send: {"Message ID": 344}.
Telemetry message send: {"Message ID": 345}.
Telemetry message send: {"Message ID": 346}.
Telemetry message send: {"Message ID": 347}.
```

Figure 2.26 Received Message

2.7 IoT Embedded SDK PnP sample project (Available up to Azure RTOS v.6.2.1_rel-rx-2.0.0)

This demonstration connects to Azure IoT Hub using Azure IoT middleware for Azure RTOS. This demonstration also publishes the message to IoT Hub every few seconds.

It is also possible to view device properties, view device telemetry, update device twin and call a direct method on device using Azure IoT Explorer.

Supported Kits:

- Renesas Starter Kit+ for RX65N-2MB
- CK-RX65N cloud kit (Ether/ Cellular)
- Renesas RX65N Cloud Kit
- Renesas Starter Kit+ for RX671
- RX72N Envision Kit

To run this project, simply follow **2.5 IoT Embedded SDK sample project**.

Moreover, this sample can interact with IoT Plug and Play components using Azure IoT Explorer.

To interact with IoT Plug and Play components using Azure IoT Explorer:

You can use Azure IoT Explorer to interact with IoT Plug and Play components.

Azure IoT explorer needs a local copy of the model file that matches the **Model ID** your device sends. The model file lets Azure IoT explorer display the telemetry, properties, and commands that your device implements.

To use the Azure IoT explorer to verify the IoT Plug and Play device application is working:

1. In IoT Explorer, select the **IoT Plug and Play Settings**.
2. Select **Add** and select **Public Repository**.
3. Select **Save**.

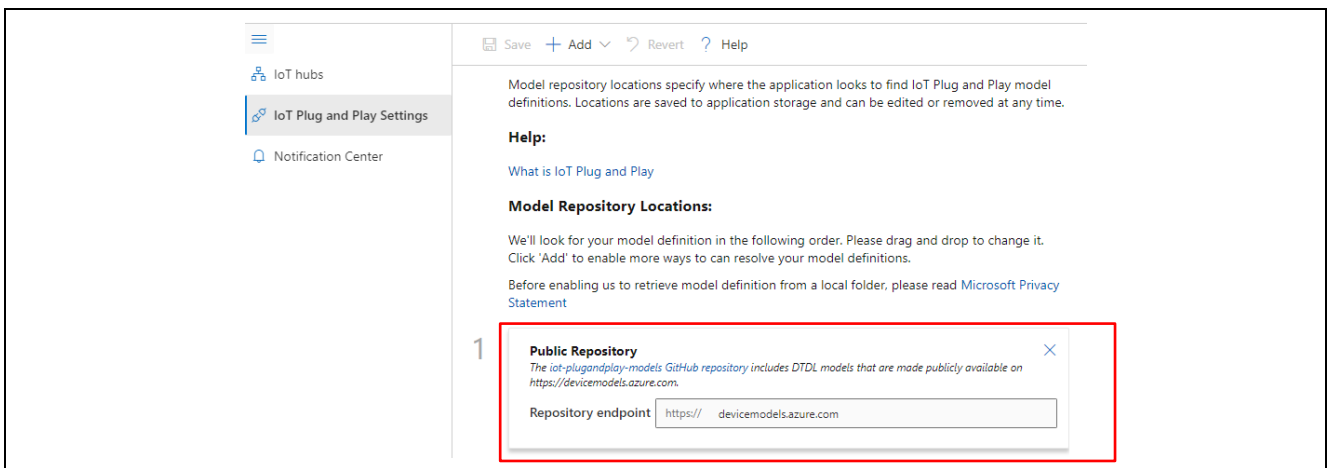

Figure 2.27 IoT Plug and Play Setting

Azure RTOS sample projects using e2 studio or IAR EW

- On the **IoT hubs** page, click on the name of the hub you want to work with. You see a list of devices registered to the IoT hub.
- Click on the **Device ID** of the device you created previously.
- The menu on the left shows the different types of information available for the device.
- Select **IoT Plug and Play components** to view the model information for your device.

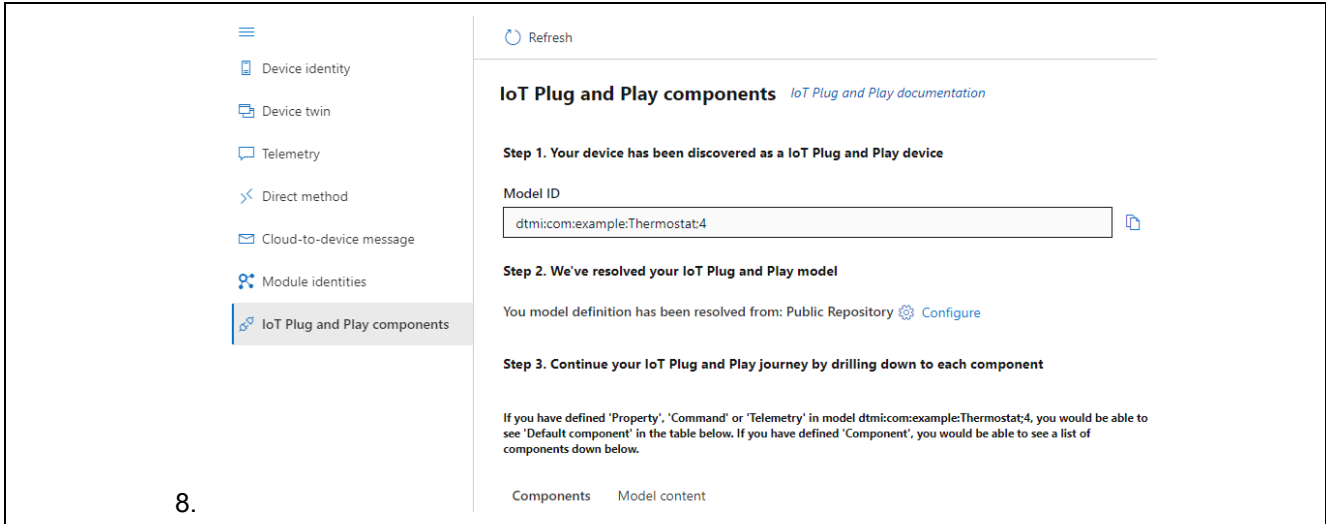

Figure 2.28 Model Information

- You can view the different components of the device. The default component and any additional ones. Select a component to work with.
- Select the **Telemetry** page and then select Start to view the telemetry data the device is sending for this component.
- Select the **Properties (read-only)** page to view the read-only properties reported for this component.
- Select the **Properties (writable)** page to view the writable properties you can update for this component.
- Select a property by its **name**, enter a new value for it, and select **Update desired value**.
- To see the new value show up select the **Refresh** button.
- Select the **Commands** page to view all the commands for this component.
- Select the command you want to test set the parameter if any. Select **Send command** to call the command on the device. You can see your device respond to the command in the command prompt window where the sample code is running.

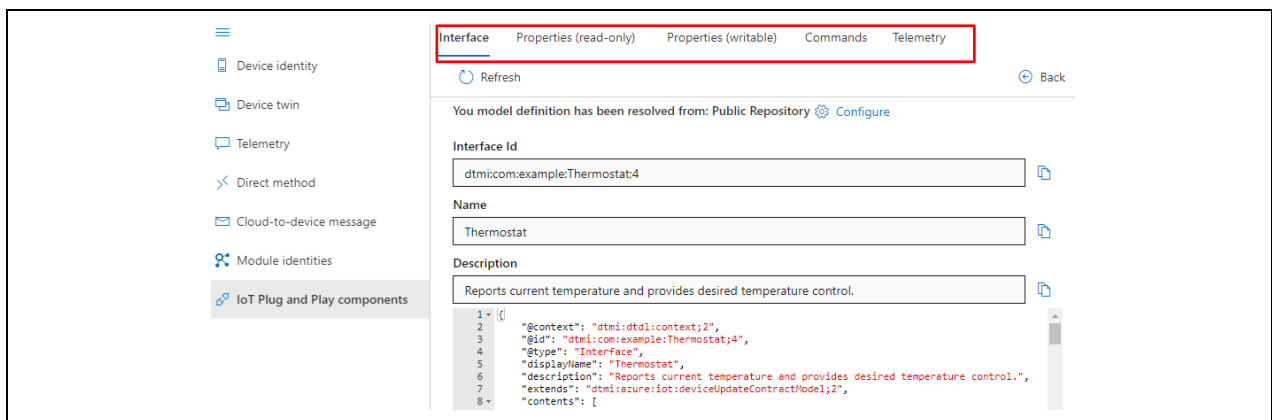

Figure 2.29 IoT Plug and Play Components

2.8 GUIX 8bpp/16bpp/16bpp_draw2d sample project

This demonstration illustrates Washing Machine application using advanced GUIX features such as:

- Widget creation
- Creating multiple screens inside the main screen
- Attaching and detaching the child screen when you switch screens
- Double-buffer toggle control for screen transition without tearing
- Radial slider, vertical and horizontal slider creation
- Running animation

It also illustrates 2 kinds color depth and use of 2D drawing engine (DRW2D) on RX family.

- **sample_guix_8bpp:**
sample for display of size 480 * 272 with 8 bits color look-up table (CLUT8).
- **sample_guix_16bpp:**
sample for display of size 480 * 272 with 16 bits RGB 565.
- **sample_guix_16bpp_draw2d:**
sample for display of size 480 * 272 with 16 bits RGB 565 with 2D drawing engine.

Supported Kits:

- Renesas Starter Kit+ for RX65N-2MB
- RX72N Envision Kit

To run each GUIX Sample project, simply follow these steps (assuming the steps described in the previous section were done):

1. Select **Go** to start execution of the demonstration. As the project runs you should observe Washing Machine GUI on board TFT panel. The four different screens are demonstrated as:

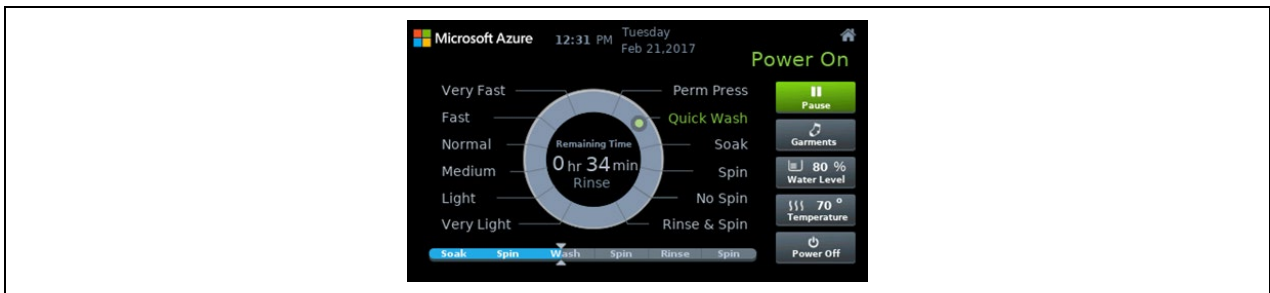

Figure 2.30 Main Screen

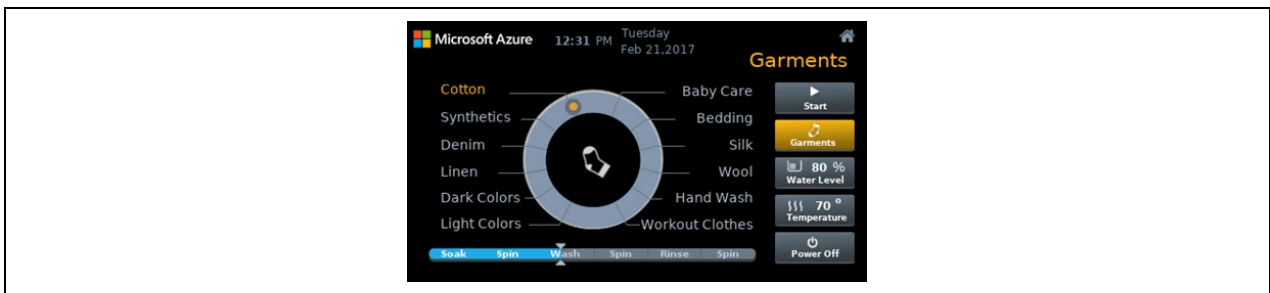

Figure 2.31 Garments selection screen

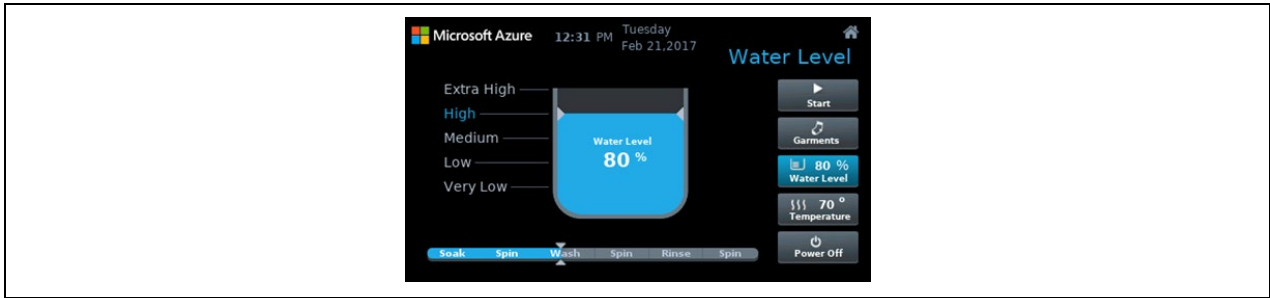

Figure 2.32 Water level selection screen

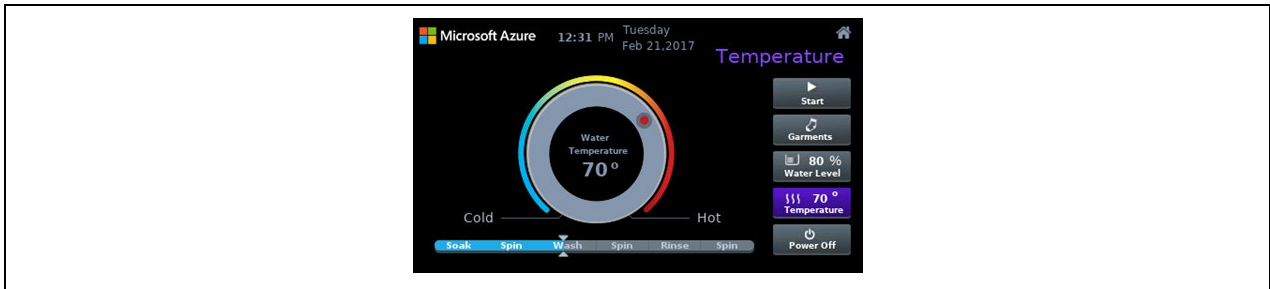

Figure 2.33 Temperature selection screen

The application demonstrates the simulation of the Washing Machine controller from the GUI perspective. This project initializes the GUIX system, configures the GUIX drivers, initializes Canvas, creates screens using widget creation APIs, starts the GUIX and handles the Touch Events from the Touch driver. All these are done from the Application Thread.

To learn more about Azure RTOS GUIX, view <https://docs.microsoft.com/azure/rtos/guix/>.

2.9 USBX device CDC-ACM Class sample project

This demonstration illustrates the setup and use of USBX device CDC-ACM Class to communicate with the host as a serial device. This project initializes the USBX system and device stack, set the parameters for callback when insertion/extraction of a CDC device, read from the CDC class and write to the CDC instance using device CDC-ACM APIs.

Supported Kits:

- Renesas Starter Kit+ for RX65N-2MB
- CK-RX65N cloud kit
- Renesas RX65N Cloud Kit

Before build the sample and run, you need to connect the USB0 Function on Renesas Starter Kit+ for RX65N-2MB to your computer using the USB-MiniB cable: (assuming Renesas Starter Kit+ for RX65N-2MB is specified as Target Board)

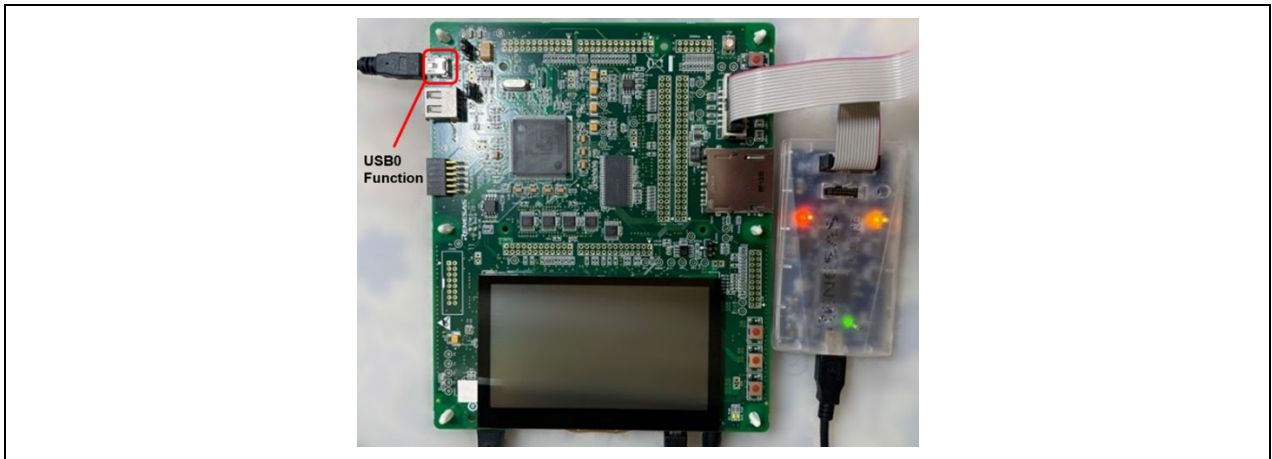

Figure 2.34 USB0 Function on Renesas Starter Kit+ for RX65N-2MB

To run the device CDC-ACM Sample project, simply follow these steps (assuming the steps described in the previous section were done):

1. Select **Go** to start execution of the demonstration.
2. Verify the serial port in your OS's device manager. It should show up as a COM port for the CDC-ACM device.

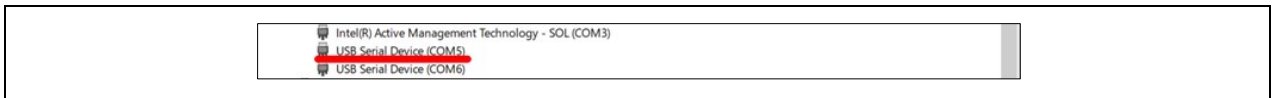

Figure 2.35 Device Manager

3. Open your favorite serial terminal program such as Putty and connect to the COM port discovered above. In this sample project, it is not necessary to set any other settings on the terminal program.
4. As the project runs, you should be able to observe “abcdef” returned from the CDC-ACM device when you input **enter** key to the CDC-ACM device via the terminal.

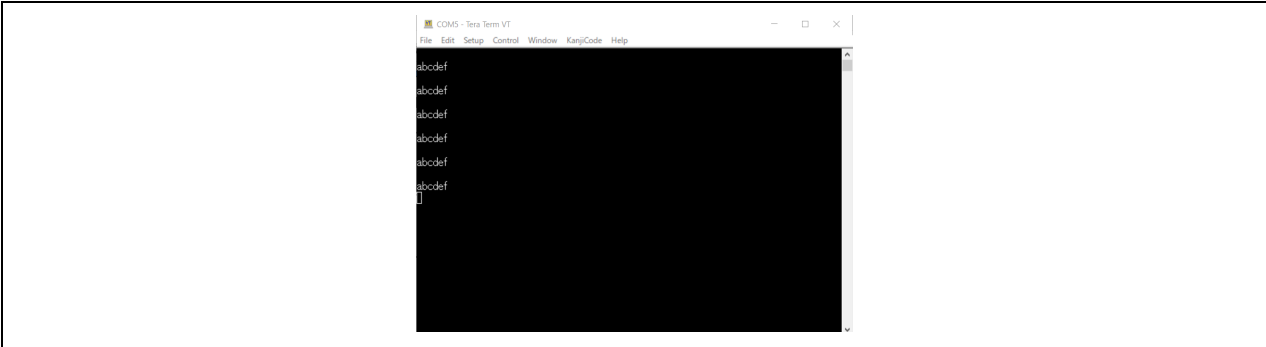

Figure 2.36 Serial Terminal Window

To learn more about Azure RTOS USBX, view <https://docs.microsoft.com/azure/rtos/usbx/>.

2.10 USBX Host Mass Storage Class sample project

This demonstration illustrates the setup and communication with MSC device (USB flash drive) using USBX HMSC. The sample program initializes the FileX, USBX system and USB driver stack. When a MSC device is inserted, it reads and writes a file to MSC device using device FileX APIs.

Supported Kits:

- Renesas Starter Kit+ for RX65N-2MB
- CK-RX65N cloud kit
- Renesas RX65N Cloud Kit
- Renesas Starter Kit+ for RX671

1. Change the jumper pins (J7 and J16) on Renesas Start Kit+(RSK) for RX65N-2MB to set to USB Host mode. (assuming Renesas Starter Kit+ for RX65N-2MB is specified as Target Board)

Note: Jumper pin numbers are different for each RSK.

2. Build USBX HMSC sample project and run.
3. Connect MSC device to USB Standard A connector (red frame) on RSK.

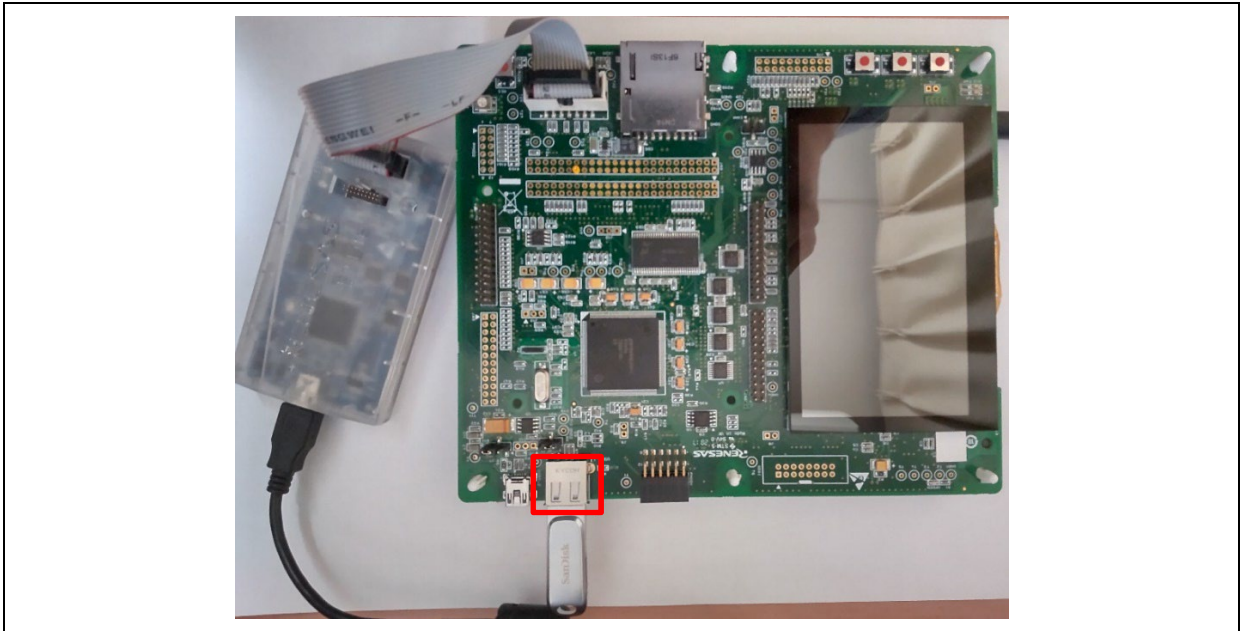

Figure 2.37 USB Standard A Connector on Renesas Starter Kit+ for RX65N-2MB

When the USBX HMSC driver recognizes that MSC device is connected, the sample application program creates a "counter.txt" file to MSC device using FileX API.

4. Disconnect MSC device from RSK and connect MSC drive to PC.
5. Confirm that "counter.txt" file is generated at the root folder in the MSC device.

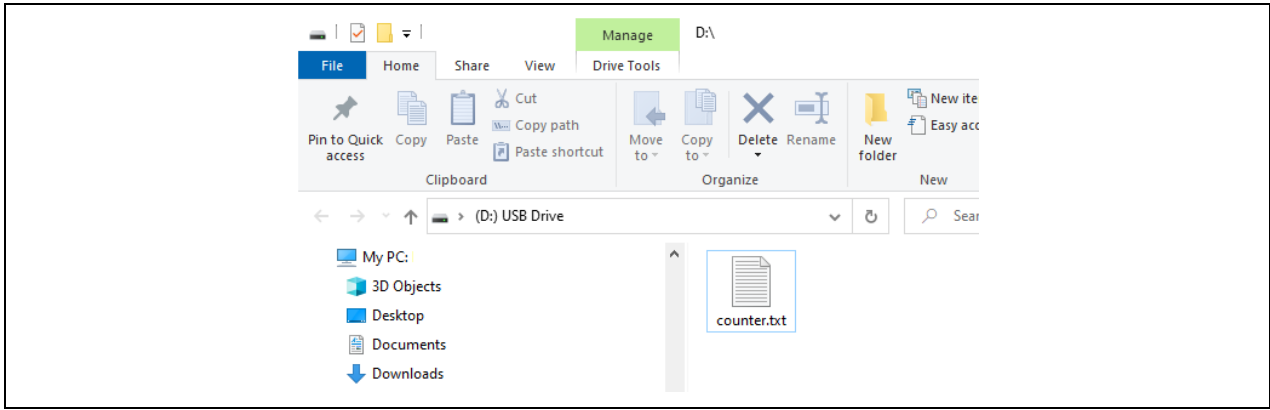

Figure 2.38 Root Folder in MSC Device

- Open “counter.txt” file using the binary editor on PC. It contains count up numbers from 0x0000 to 0x00FF from the address 0x00000000 as following.

ADDRESS	00	01	02	03	04	05	06	07	08	09	0A	0B	0C	0D	0E	0F	0123456789ABCDEF
00000000	00	00	01	00	02	00	03	00	04	00	05	00	06	00	07	00
00000010	08	00	09	00	0A	00	0B	00	0C	00	0D	00	0E	00	0F	00
00000020	10	00	11	00	12	00	13	00	14	00	15	00	16	00	17	00
00000030	18	00	19	00	1A	00	1B	00	1C	00	1D	00	1E	00	1F	00
00000040	20	00	21	00	22	00	23	00	24	00	25	00	26	00	27	00	!.@#.\$%&./
00000050	28	00	29	00	2A	00	2B	00	2C	00	2D	00	2E	00	2F	00	().*+,-./:
00000060	30	00	31	00	32	00	33	00	34	00	35	00	36	00	37	00	0.1.2.3.4.5.6.7.
00000070	38	00	39	00	3A	00	3B	00	3C	00	3D	00	3E	00	3F	00	8.9.:;.<.=.>?.
00000080	40	00	41	00	42	00	43	00	44	00	45	00	46	00	47	00	@.A.B.C.D.E.F.G.
00000090	48	00	49	00	4A	00	4B	00	4C	00	4D	00	4E	00	4F	00	H.I.J.K.L.M.N.O.
000000A0	50	00	51	00	52	00	53	00	54	00	55	00	56	00	57	00	P.Q.R.S.T.U.V.W.
000000B0	58	00	59	00	5A	00	5B	00	5C	00	5D	00	5E	00	5F	00	X.Y.Z.[\].^_.
000000C0	60	00	61	00	62	00	63	00	64	00	65	00	66	00	67	00	`a.b.c.d.e.f.g.
000000D0	68	00	69	00	6A	00	6B	00	6C	00	6D	00	6E	00	6F	00	h.i.j.k.l.m.n.o.
000000E0	70	00	71	00	72	00	73	00	74	00	75	00	76	00	77	00	p.q.r.s.t.u.v.w.
000000F0	78	00	79	00	7A	00	7B	00	7C	00	7D	00	7E	00	7F	00	x.y.z.[\].^_.
00000100	80	00	81	00	82	00	83	00	84	00	85	00	86	00	87	00
00000110	88	00	89	00	8A	00	8B	00	8C	00	8D	00	8E	00	8F	00
00000120	90	00	91	00	92	00	93	00	94	00	95	00	96	00	97	00
00000130	98	00	99	00	9A	00	9B	00	9C	00	9D	00	9E	00	9F	00
00000140	A0	00	A1	00	A2	00	A3	00	A4	00	A5	00	A6	00	A7	00
00000150	A8	00	A9	00	AA	00	AB	00	AC	00	AD	00	AE	00	AF	00

Figure 2.39 Content of “counter.txt”

- Disconnect MSC device from PC and connect the MSC device to RSK. This sample program reads “counter.txt” in MSC device and adds the count up data from the address (0x00000200) in this file.
- Disconnect MSC device from RSK and connect the MSC drive to PC.
- Open “counter.txt” file using the binary editor on PC. It contains count up numbers from 0x0000 to 0x00FF from the address 0x00000200 as following.

ADDRESS	00	01	02	03	04	05	06	07	08	09	0A	0B	0C	0D	0E	0F	0123456789ABCDEF
00000200	00	01	01	01	02	01	03	01	04	01	05	01	06	01	07	01
00000210	08	01	09	01	0A	01	0B	01	0C	01	0D	01	0E	01	0F	01
00000220	10	01	11	01	12	01	13	01	14	01	15	01	16	01	17	01
00000230	18	01	19	01	1A	01	1B	01	1C	01	1D	01	1E	01	1F	01
00000240	20	01	21	01	22	01	23	01	24	01	25	01	26	01	27	01	!.@#.\$%&./
00000250	28	01	29	01	2A	01	2B	01	2C	01	2D	01	2E	01	2F	01	().*+,-./:
00000260	30	01	31	01	32	01	33	01	34	01	35	01	36	01	37	01	0.1.2.3.4.5.6.7.
00000270	38	01	39	01	3A	01	3B	01	3C	01	3D	01	3E	01	3F	01	8.9.:;.<.=.>?.
00000280	40	01	41	01	42	01	43	01	44	01	45	01	46	01	47	01	@.A.B.C.D.E.F.G.
00000290	48	01	49	01	4A	01	4B	01	4C	01	4D	01	4E	01	4F	01	H.I.J.K.L.M.N.O.
000002A0	50	01	51	01	52	01	53	01	54	01	55	01	56	01	57	01	P.Q.R.S.T.U.V.W.
000002B0	58	01	59	01	5A	01	5B	01	5C	01	5D	01	5E	01	5F	01	X.Y.Z.[\].^_.
000002C0	60	01	61	01	62	01	63	01	64	01	65	01	66	01	67	01	`a.b.c.d.e.f.g.
000002D0	68	01	69	01	6A	01	6B	01	6C	01	6D	01	6E	01	6F	01	h.i.j.k.l.m.n.o.
000002E0	70	01	71	01	72	01	73	01	74	01	75	01	76	01	77	01	p.q.r.s.t.u.v.w.
000002F0	78	01	79	01	7A	01	7B	01	7C	01	7D	01	7E	01	7F	01	x.y.z.[\].^_.
00000300	80	01	81	01	82	01	83	01	84	01	85	01	86	01	87	01
00000310	88	01	89	01	8A	01	8B	01	8C	01	8D	01	8E	01	8F	01
00000320	90	01	91	01	92	01	93	01	94	01	95	01	96	01	97	01
00000330	98	01	99	01	9A	01	9B	01	9C	01	9D	01	9E	01	9F	01
00000340	A0	01	A1	01	A2	01	A3	01	A4	01	A5	01	A6	01	A7	01
00000350	A8	01	A9	01	AA	01	AB	01	AC	01	AD	01	AE	01	AF	01

Figure 2.40 Content of “counter.txt”

10. By repeating steps 8 and 9 above, the sample program keeps updating count data to “counter.txt” file in the MSC device.

To learn more about Azure RTOS USBX, view <https://docs.microsoft.com/azure/rtos/usbx/>.

2.11 USBX Host Communication Device Class (CDC-ACM) sample project

This demonstration illustrates the setup and communication with HCDC device using USBX HCDC driver (HCDC-ACM). This project initializes the USBX system and USB driver, set the parameters for callback when insertion/extraction of a CDC device, read from the CDC class and write to the CDC instance using Host CDC-ACM APIs.

Supported Kits:

- Renesas Starter Kit+ for RX65N-2MB
- CK-RX65N cloud kit
- Renesas RX65N Cloud Kit
- Renesas Starter Kit+ for RX671

1. Change the jumper pins (J7 and J16) on Renesas Start Kit+(RSK) for RX65N-2MB to set to USB Host mode. (assuming Renesas Starter Kit+ for RX65N-2MB is specified as Target Board)

Note: Jumper pin numbers are different for each RSK.

2. Build USBX HCDC sample project and run.
3. Connect CDC device to USB Standard A connector (red frame) on RSK.

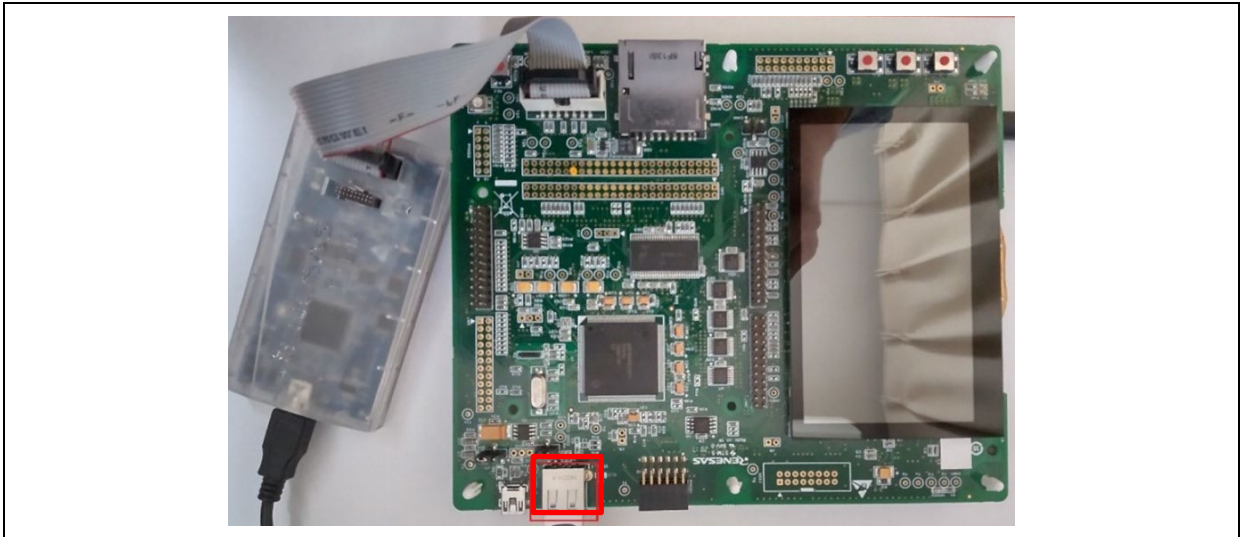

Figure 2.41 USB Standard A Connector on Renesas Starter Kit+ for RX65N-2MB

Note:

Please connect this CDC device to a PC (Windows) via UART and start the terminal program on this PC.

4. When user input key data on the terminal, the input key data send to CDC device via UART.
5. CDC device received key data sends the key data to USB Host CDC device (RSK) via USB.
6. USB Host CDC device (RSK) received key data sends the key data to CDC device. (Loopback)
7. CDC device received key data sends to terminal program on PC via UART.
8. User is able to observe key data on terminal program.

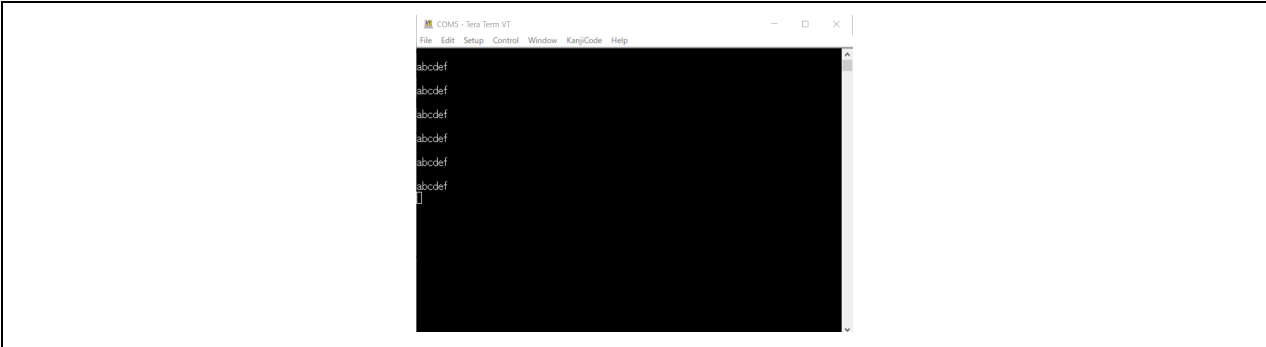

Figure 2.42 Serial Terminal Window

To learn more about Azure RTOS USBX, view <https://docs.microsoft.com/azure/rtos/usbx/>.

2.12 ThreadX Low Power sample project

This sample project illustrates how to use ThreadX's Low Power feature. You can confirm the transition to and resume from the following low power modes supported by the device using the Low Power Consumption Device Driver Module (r_lpc_rx).

Kits	Target Board for RX130 Renesas Starter Kit for RX140 Renesas Solution Starter Kit for RX23E-B	Renesas Starter Kit+ for RX65N-2MB CK-RX65N cloud kit Renesas RX65N Cloud Kit Renesas Starter Kit for RX660 Renesas Starter Kit+ for RX671 RX72N Envision Kit
Device	RX130, RX140, RX23E-B	RX65N, RX651, RX660, RX72N, RX671
Supported low power mode	Sleep Mode Deep Sleep Mode Software Standby Mode	Sleep Mode Software Standby Mode Deep Software Standby Mode

2.12.1 Overview of sample project

1. The sample project creates one thread **thread_0**. The **thread_0** turns on the LED when it starts.
2. After executing for about 3 seconds, suspend the own thread by **tx_thread_suspend**.
3. Since there is no other thread to run, **Demo_LowPower_Enter** configured in ThreadX "Enter low power function" configuration is called from **tx_low_power_enter** of ThreadX.
4. **Demo_LowPower_Enter** turns off the LED and transitions to the low power consumption mode.
5. The low power consumption mode is resumed by the interruption of pressing the user switch. The interrupt handler **Demo_callback** is called and **tx_thread_resume** resumes **thread_0**. At this point, **thread_0** does not run.
If it has transitioned to the deep software standby mode, it will be resumed by the user switch press interrupt or RTC alarm interrupt and reboots from the reset vector.
6. Next, the **Demo_LowPower_Exit** configured in the ThreadX "Exit low power function" configuration is called from **tx_low_power_exit** of ThreadX. **Demo_LowPower_Exit** turns on the LED and returns to ThreadX.
7. The resumed **thread_0** runs.
8. Repeat the transition to the same low power consumption mode in steps 2 to 7 three times in total and execute all low power consumption modes in the following order.

For RX130, RX140 and RX23E-B:

Sleep Mode (3 times) => Deep Sleep Mode (3 times) => Software Standby Mode (3 times)

For RX65N, RX651, RX660, RX72N, RX671:

Sleep Mode (3 times) => Software Standby Mode (3 times) => Deep Software Standby Mode (1 time)

The figure shows the execution flow from suspending the thread_0 with tx_thread_suspend to resuming.

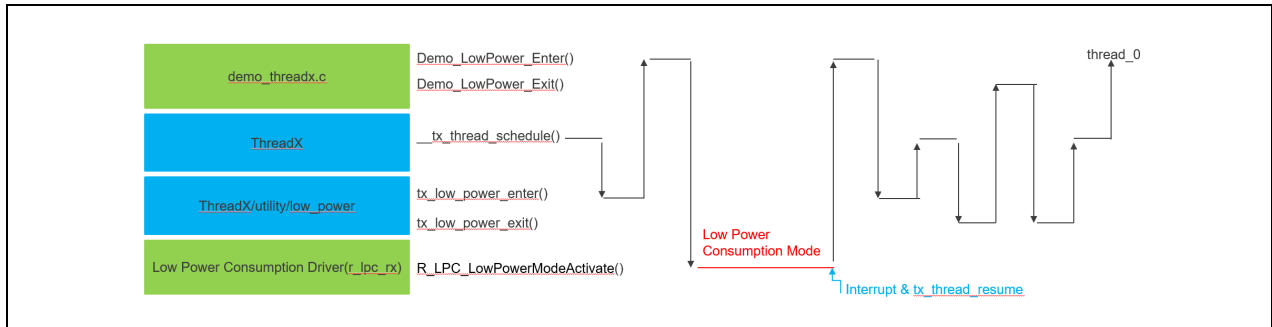

Figure 2.43 Execution Flow after tx_thread_suspend (&thread_0)

2.12.2 Execute sample project

To run the sample project, simply follow these steps for each board:

Target Board for RX130, Renesas Starter Kit for RX140 and Renesas Solution Starter Kit for RX23E-B:

1. Select **Launch** to download the program.
2. Select **Resume** to start execution of the project. The program stops at the breakpoint of main function.
3. Select **Resume** to restart.
4. The program turns LED0(RX130 and RX140)/LED1(RX23E-B) on and runs for 3 seconds.
5. The program turns LED0(RX130 and RX140)/LED1(RX23E-B) off and transitions to sleep mode. e² studio status bar will change from Running to Sleeping as below:



6. The program is resumed by pressing the user switch (SW1). This cycle is repeated 3 times.
7. Similarly, transitions to deep sleep mode and resume by pressing the user switch is repeated 3 times. e² studio status bar will change from Running to Sleeping as below:



8. Similarly, transitions to software standby mode and resume by pressing the user switch is repeated 3 times. e² studio status bar will change from Running to Standby as below:



9. Repeat from sleep mode to software standby mode.

(* e² studio status bar when sleep mode and deep sleep are the same. So please check MSTPCRC.DSLPE register value before executing wait instruction.

- sleep mode: MSTPCRC.DSLPE =0
- deep sleep: MSTPCRC.DSLPE =1

RX65N Cloud Kit:

1. Select **Launch** to download the program.
2. Select **Resume** to start execution of the project. The program stops at the breakpoint of main function.
3. Select **Resume** to restart.

Azure RTOS sample projects using e2 studio or IAR EW

- The program turns LED1 on and runs for 3 seconds.
- The program turns LED1 off and transitions to sleep mode. e² studio status bar will change from Running to Sleeping as below:



- The program is resumed by pressing the user switch. This cycle is repeated 3 times.
- Similarly, transitions to software standby mode and resume by pressing the user switch is repeat 3 times. e² studio status bar will change from Running to Standby as below: (*)



- The program transitions to deep software standby. e² studio status bar will change from Running to Standby as below: (*)



- The program reboots by pressing the user switch.

(*) e2 studio status bar when deep software standby and software standby are the same. So please check SBYCR.SSBY and DPSBYCR.DPSBY register value before executing wait instruction.

- software standby: SBYCR.SSBY=1, DPSBYCR.DPSBY=0

- deep software standby: SBYCR.SSBY=1, DPSBYCR.DPSBY=1

Renesas Starter Kit+ for RX65N-2MB, Renesas Starter Kit for RX660, Renesas Starter Kit for RX671, RX72N Envision Kit and CK-RX65N:

- Select **Launch** to download the program.
- Select **Resume** to start execution of the project. The program stops at the breakpoint of main function.
- Select **Resume** to restart.
- The program turns LED (usually LED0) on and runs for 3 seconds.
- The program turns LED off and transitions to sleep mode. e² studio status bar will change from Running to Sleeping as below:



- The program is resumed by pressing the user switch (usually SW1). This cycle is repeated 3 times.
- Similarly, transitions to software standby mode and resume by pressing the user switch is repeat 3 times. e² studio status bar will change from Running to Standby as below: (*)



- The program transitions to deep software standby. e² studio status bar will change from Running to Standby as below: (*)



- The program reboots by RTC alarm interrupt after about 30 seconds.

(*) e2 studio status bar when deep software standby and software standby are the same. So please check SBYCR.SSBY and DPSBYCR.DPSBY register value before executing wait instruction.

- software standby: SBYCR.SSBY=1, DPSBYCR.DPSBY=0
- deep software standby: SBYCR.SSBY=1, DPSBYCR.DPSBY=1

2.12.3 Configuration of ThreadX Low Power by Smart Configurator

- You can develop own system low power operation for your product referring to this sample project and using Smart Configurator’s component configuration feature as below. Each configurable item description is displayed in Macro definition view by clicking the configuration item.

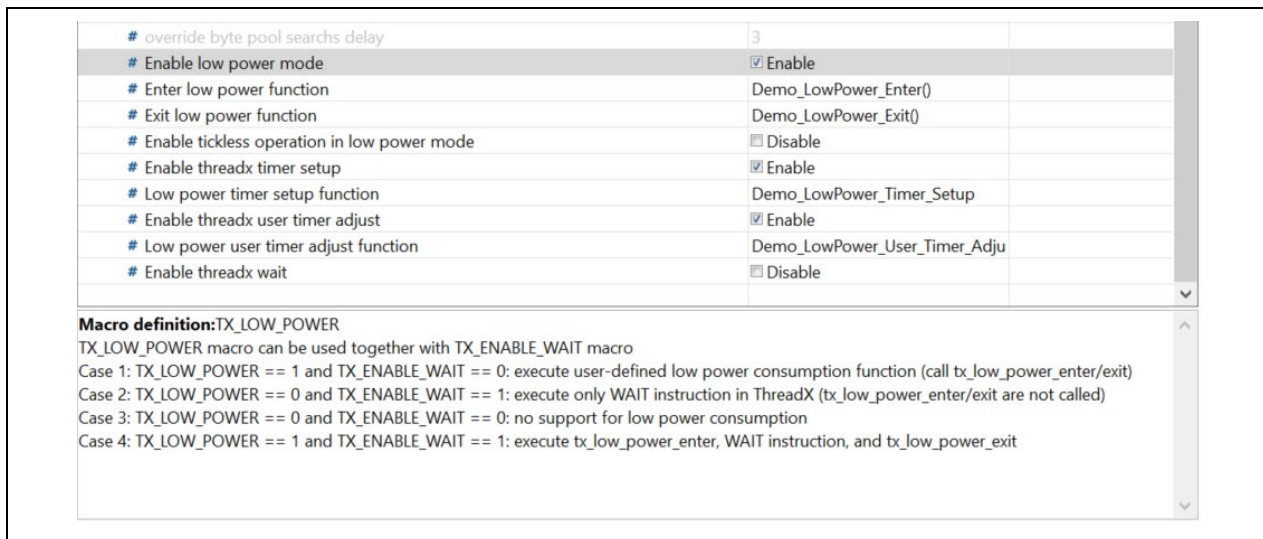

Figure 2.44 Configuration of ThreadX Low Power

- If the Low Power Consumption Device Driver Module (r_lpc_rx) is used, the module executes “WAIT” instruction inside the r_lpc_rx module. Therefore, please note that “Enable threadx wait” must be disabled.
- If you define your own function for “Enter low power function”, “Exit low power function”, “Low power timer setup function” and “Low power user timer adjust function”, please modify the prototype definition for each function in libs/threadx/tx_user.h manually as well.

```

/* Define Low Power usage */
#define TX_LOW_POWER 1

/* Define the Enter low power mode macro*/
#if TX_LOW_POWER
void Demo_LowPower_Enter(void);
#define TX_LOW_POWER_USER_ENTER Demo_LowPower_Enter()
#endif

/* Define the Exist low power mode macro*/
#if TX_LOW_POWER
void Demo_LowPower_Exit(void);
#define TX_LOW_POWER_USER_EXIT Demo_LowPower_Exit()
#endif

/* Define Low Power tickless usage */
#define USE_TX_LOW_POWER_TICKLESS 0
#if USE_TX_LOW_POWER_TICKLESS
#define TX_LOW_POWER_TICKLESS
#endif

/* Define the TX_LOW_POWER_TIMER_SETUP macro*/
#if TX_LOW_POWER && !USE_TX_LOW_POWER_TICKLESS
#define USE_TX_LOW_POWER_TIMER_SETUP 1
#endif
#if USE_TX_LOW_POWER_TIMER_SETUP
void Demo_LowPower_Timer_Setup(unsigned long tx_low_power_next_expiration); /* can not use ULONG */
#define TX_LOW_POWER_TIMER_SETUP Demo_LowPower_Timer_Setup
#endif

/* Define the TX_LOW_POWER_USER_TIMER_ADJUST macro*/
#if TX_LOW_POWER && !USE_TX_LOW_POWER_TICKLESS
#define USE_TX_LOW_POWER_USER_TIMER_ADJUST 1
#endif
#if USE_TX_LOW_POWER_USER_TIMER_ADJUST
unsigned long Demo_LowPower_User_Timer_Adjust(void); /* can not use ULONG */
#define TX_LOW_POWER_USER_TIMER_ADJUST Demo_LowPower_User_Timer_Adjust()
#endif

/* Define the TX_ENABLE_WAIT usage*/
#define TX_ENABLE_WAIT 0

```

Figure 2.45 libs/threadx/tx_user.h

- The “tx_low_power_next_expiration” parameter is passed to the “TX_LOW_POWER_TIMER_SETUP” function. Since the tx_low_power_next_expiration is the next timer deadline (i.e., the number of ticks before the next wakeup), a low power mode timer must be set so that the low power mode is resumed before this tick number elapses.

When the tx_low_power_next_expiration is 0xffffffff, there is no next timer expiration date (there is no thread waiting for a timeout), so the user may resume from the low power mode at any time.

When the tx_low_power_next_expiration is very small value, the transition to the low power consumption mode may be omitted by judging from the transition process time and the resume process time because it depends on the processing time of the user-defined function.
- For the latest information of Low Power APIs, please refer to https://github.com/azure-rtos/threadx/blob/master/utility/low_power/low_power.md .

2.13 Azure Device Update (ADU) sample project

This sample project illustrates over-the-air (OTA) firmware update via Microsoft Azure. Azure ADU is a cloud service provided by Microsoft that enables deployment of OTA updating of IoT devices.

When implementing ADU, secure boot loader sample project must be used together with this project. The secure boot loader function is to verify that firmware to be run is reliable, make sure it has not been tempered, and update it.

Supported Kits:

- Renesas Starter Kit+ for RX65N-2MB
- CK-RX65N cloud kit (Ether/ Cellular)
- Renesas RX65N Cloud Kit
- Renesas Starter Kit+ for RX671
- RX72N Envision Kit

Development Environment:

- e2 studio : 2023-10 or later

To run this sample, please see the document [“RX Family How to implement OTA by using Microsoft Azure Services”](#).

To learn more about Azure ADU, view <https://learn.microsoft.com/azure/iot-hub-device-update/>.

Revision History

Rev.	Date	Description	
		Page	Summary
1.00	Jul. 20, 2022	—	First edition issued
1.01	Oct. 20, 2022	1, 22	Changed project name from “PnP Temperature Control sample project” to “IoT Embedded SDK with IoT Plug and Play sample project”
		2	Added Azure IoT Explorer
1.02	Jan. 20, 2023	6	Improved creation procedure for IAR EW project
		24, 25	Added USBX Host Mass Storage Class sample project
		31	Added Azure Device Update sample project and secure bootloader sample project
1.03	July. 28, 2023	-	Add minimal sample explanation Remove IoT Embedded SDK with IoT Plug and Play sample project
2.00	Jan. 12, 2024	-	Supported RX23E-B Added USBX HCDC sample Updated Azure Device Update (ADU) sample project explanation.
2.10	July. 1, 2024	-	Supported Azure RTOS v.6.4.0 Unsupported IoT Embedded SDK PnP sample project from Azure RTOS v.6.4.0

General Precautions in the Handling of Microprocessing Unit and Microcontroller Unit Products

The following usage notes are applicable to all Microprocessing unit and Microcontroller unit products from Renesas. For detailed usage notes on the products covered by this document, refer to the relevant sections of the document as well as any technical updates that have been issued for the products.

1. Precaution against Electrostatic Discharge (ESD)

A strong electrical field, when exposed to a CMOS device, can cause destruction of the gate oxide and ultimately degrade the device operation. Steps must be taken to stop the generation of static electricity as much as possible, and quickly dissipate it when it occurs. Environmental control must be adequate. When it is dry, a humidifier should be used. This is recommended to avoid using insulators that can easily build up static electricity.

Semiconductor devices must be stored and transported in an anti-static container, static shielding bag or conductive material. All test and measurement tools including work benches and floors must be grounded. The operator must also be grounded using a wrist strap. Semiconductor devices must not be touched with bare hands. Similar precautions must be taken for printed circuit boards with mounted semiconductor devices.

2. Processing at power-on

The state of the product is undefined at the time when power is supplied. The states of internal circuits in the LSI are indeterminate and the states of register settings and pins are undefined at the time when power is supplied. In a finished product where the reset signal is applied to the external reset pin, the states of pins are not guaranteed from the time when power is supplied until the reset process is completed. In a similar way, the states of pins in a product that is reset by an on-chip power-on reset function are not guaranteed from the time when power is supplied until the power reaches the level at which resetting is specified.

3. Input of signal during power-off state

Do not input signals or an I/O pull-up power supply while the device is powered off. The current injection that results from input of such a signal or I/O pull-up power supply may cause malfunction and the abnormal current that passes in the device at this time may cause degradation of internal elements. Follow the guideline for input signal during power-off state as described in your product documentation.

4. Handling of unused pins

Handle unused pins in accordance with the directions given under handling of unused pins in the manual. The input pins of CMOS products are generally in the high-impedance state. In operation with an unused pin in the open-circuit state, extra electromagnetic noise is induced in the vicinity of the LSI, an associated shoot-through current flows internally, and malfunctions occur due to the false recognition of the pin state as an input signal become possible.

5. Clock signals

After applying a reset, only release the reset line after the operating clock signal becomes stable. When switching the clock signal during program execution, wait until the target clock signal is stabilized. When the clock signal is generated with an external resonator or from an external oscillator during a reset, ensure that the reset line is only released after full stabilization of the clock signal. Additionally, when switching to a clock signal produced with an external resonator or by an external oscillator while program execution is in progress, wait until the target clock signal is stable.

6. Voltage application waveform at input pin

Waveform distortion due to input noise or a reflected wave may cause malfunction. If the input of the CMOS device stays in the area between V_{IL} (Max.) and V_{IH} (Min.) due to noise, for example, the device may malfunction. Take care to prevent chattering noise from entering the device when the input level is fixed, and also in the transition period when the input level passes through the area between V_{IL} (Max.) and V_{IH} (Min.).

7. Prohibition of access to reserved addresses

Access to reserved addresses is prohibited. The reserved addresses are provided for possible future expansion of functions. Do not access these addresses as the correct operation of the LSI is not guaranteed.

8. Differences between products

Before changing from one product to another, for example to a product with a different part number, confirm that the change will not lead to problems. The characteristics of a microprocessing unit or microcontroller unit products in the same group but having a different part number might differ in terms of internal memory capacity, layout pattern, and other factors, which can affect the ranges of electrical characteristics, such as characteristic values, operating margins, immunity to noise, and amount of radiated noise. When changing to a product with a different part number, implement a system-evaluation test for the given product.

Notice

1. Descriptions of circuits, software and other related information in this document are provided only to illustrate the operation of semiconductor products and application examples. You are fully responsible for the incorporation or any other use of the circuits, software, and information in the design of your product or system. Renesas Electronics disclaims any and all liability for any losses and damages incurred by you or third parties arising from the use of these circuits, software, or information.
2. Renesas Electronics hereby expressly disclaims any warranties against and liability for infringement or any other claims involving patents, copyrights, or other intellectual property rights of third parties, by or arising from the use of Renesas Electronics products or technical information described in this document, including but not limited to, the product data, drawings, charts, programs, algorithms, and application examples.
3. No license, express, implied or otherwise, is granted hereby under any patents, copyrights or other intellectual property rights of Renesas Electronics or others.
4. You shall be responsible for determining what licenses are required from any third parties, and obtaining such licenses for the lawful import, export, manufacture, sales, utilization, distribution or other disposal of any products incorporating Renesas Electronics products, if required.
5. You shall not alter, modify, copy, or reverse engineer any Renesas Electronics product, whether in whole or in part. Renesas Electronics disclaims any and all liability for any losses or damages incurred by you or third parties arising from such alteration, modification, copying or reverse engineering.
6. Renesas Electronics products are classified according to the following two quality grades: "Standard" and "High Quality". The intended applications for each Renesas Electronics product depends on the product's quality grade, as indicated below.
 - "Standard": Computers; office equipment; communications equipment; test and measurement equipment; audio and visual equipment; home electronic appliances; machine tools; personal electronic equipment; industrial robots; etc.
 - "High Quality": Transportation equipment (automobiles, trains, ships, etc.); traffic control (traffic lights); large-scale communication equipment; key financial terminal systems; safety control equipment; etc.Unless expressly designated as a high reliability product or a product for harsh environments in a Renesas Electronics data sheet or other Renesas Electronics document, Renesas Electronics products are not intended or authorized for use in products or systems that may pose a direct threat to human life or bodily injury (artificial life support devices or systems; surgical implantations; etc.), or may cause serious property damage (space system; undersea repeaters; nuclear power control systems; aircraft control systems; key plant systems; military equipment; etc.). Renesas Electronics disclaims any and all liability for any damages or losses incurred by you or any third parties arising from the use of any Renesas Electronics product that is inconsistent with any Renesas Electronics data sheet, user's manual or other Renesas Electronics document.
7. No semiconductor product is absolutely secure. Notwithstanding any security measures or features that may be implemented in Renesas Electronics hardware or software products, Renesas Electronics shall have absolutely no liability arising out of any vulnerability or security breach, including but not limited to any unauthorized access to or use of a Renesas Electronics product or a system that uses a Renesas Electronics product. RENESAS ELECTRONICS DOES NOT WARRANT OR GUARANTEE THAT RENESAS ELECTRONICS PRODUCTS, OR ANY SYSTEMS CREATED USING RENESAS ELECTRONICS PRODUCTS WILL BE INVULNERABLE OR FREE FROM CORRUPTION, ATTACK, VIRUSES, INTERFERENCE, HACKING, DATA LOSS OR THEFT, OR OTHER SECURITY INTRUSION ("Vulnerability Issues"). RENESAS ELECTRONICS DISCLAIMS ANY AND ALL RESPONSIBILITY OR LIABILITY ARISING FROM OR RELATED TO ANY VULNERABILITY ISSUES. FURTHERMORE, TO THE EXTENT PERMITTED BY APPLICABLE LAW, RENESAS ELECTRONICS DISCLAIMS ANY AND ALL WARRANTIES, EXPRESS OR IMPLIED, WITH RESPECT TO THIS DOCUMENT AND ANY RELATED OR ACCOMPANYING SOFTWARE OR HARDWARE, INCLUDING BUT NOT LIMITED TO THE IMPLIED WARRANTIES OF MERCHANTABILITY, OR FITNESS FOR A PARTICULAR PURPOSE.
8. When using Renesas Electronics products, refer to the latest product information (data sheets, user's manuals, application notes, "General Notes for Handling and Using Semiconductor Devices" in the reliability handbook, etc.), and ensure that usage conditions are within the ranges specified by Renesas Electronics with respect to maximum ratings, operating power supply voltage range, heat dissipation characteristics, installation, etc. Renesas Electronics disclaims any and all liability for any malfunctions, failure or accident arising out of the use of Renesas Electronics products outside of such specified ranges.
9. Although Renesas Electronics endeavors to improve the quality and reliability of Renesas Electronics products, semiconductor products have specific characteristics, such as the occurrence of failure at a certain rate and malfunctions under certain use conditions. Unless designated as a high reliability product or a product for harsh environments in a Renesas Electronics data sheet or other Renesas Electronics document, Renesas Electronics products are not subject to radiation resistance design. You are responsible for implementing safety measures to guard against the possibility of bodily injury, injury or damage caused by fire, and/or danger to the public in the event of a failure or malfunction of Renesas Electronics products, such as safety design for hardware and software, including but not limited to redundancy, fire control and malfunction prevention, appropriate treatment for aging degradation or any other appropriate measures. Because the evaluation of microcomputer software alone is very difficult and impractical, you are responsible for evaluating the safety of the final products or systems manufactured by you.
10. Please contact a Renesas Electronics sales office for details as to environmental matters such as the environmental compatibility of each Renesas Electronics product. You are responsible for carefully and sufficiently investigating applicable laws and regulations that regulate the inclusion or use of controlled substances, including without limitation, the EU RoHS Directive, and using Renesas Electronics products in compliance with all these applicable laws and regulations. Renesas Electronics disclaims any and all liability for damages or losses occurring as a result of your noncompliance with applicable laws and regulations.
11. Renesas Electronics products and technologies shall not be used for or incorporated into any products or systems whose manufacture, use, or sale is prohibited under any applicable domestic or foreign laws or regulations. You shall comply with any applicable export control laws and regulations promulgated and administered by the governments of any countries asserting jurisdiction over the parties or transactions.
12. It is the responsibility of the buyer or distributor of Renesas Electronics products, or any other party who distributes, disposes of, or otherwise sells or transfers the product to a third party, to notify such third party in advance of the contents and conditions set forth in this document.
13. This document shall not be reprinted, reproduced or duplicated in any form, in whole or in part, without prior written consent of Renesas Electronics.
14. Please contact a Renesas Electronics sales office if you have any questions regarding the information contained in this document or Renesas Electronics products.

(Note1) "Renesas Electronics" as used in this document means Renesas Electronics Corporation and also includes its directly or indirectly controlled subsidiaries.

(Note2) "Renesas Electronics product(s)" means any product developed or manufactured by or for Renesas Electronics.

(Rev.5.0-1 October 2020)

Corporate Headquarters

TOYOSU FORESIA, 3-2-24 Toyosu,
Koto-ku, Tokyo 135-0061, Japan
www.renesas.com

Trademarks

Renesas and the Renesas logo are trademarks of Renesas Electronics Corporation. All trademarks and registered trademarks are the property of their respective owners.

Contact information

For further information on a product, technology, the most up-to-date version of a document, or your nearest sales office, please visit:
www.renesas.com/contact/.