

Application Note

High Voltage Zero-Crossing Relay Driver

AN-CM-315

Abstract

This application note describes how to make a high voltage relay driver that switches at zero-crossing with the SLG47105 GreenPAK. It uses a half wave rectifier and optocoupler to provide a zero-crossing voltage detector (ZCVD) externally. It is also delayed internally to account for the operating time of the relay and ZCVD circuit so the relay switches at a future zero-crossing.

High Voltage Zero-Crossing Relay Driver

Contents

Abstract	1
Contents	2
Figures	2
1 Terms and Definitions	3
2 References	3
3 Introduction	4
4 What is a Relay?	4
5 Zero Voltage Switching	4
6 External Circuit	5
7 GreenPAK Design	7
8 Test	8
9 Conclusion	10
Revision History	11

Figures

Figure 1: Sketch of A Relay	4
Figure 2: Zero-Crossing Voltage Detector Circuit	5
Figure 3: External Circuit Schematic	5
Figure 4: Simulation Results	6
Figure 5: Rising AC Edge Detection.....	6
Figure 6: Falling AC Edge Detection	6
Figure 7: View of GreenPAK Design	7
Figure 8: Relay does not close at true zero-crossing with 7.407ms Delay	8
Figure 9: Measurement of the actual operation time of the relay	9
Figure 10: Relay closing at true zero-crossing with 4.793ms delay	9
Figure 11: Relay opening at true zero-crossing with 4.793ms delay	10

High Voltage Zero-Crossing Relay Driver

1 Terms and Definitions

ZVS	Zero Voltage Switching
ZCVD	Zero Crossing Voltage Detect
OCP	Overcurrent Protection
UVP	Undervoltage Protection

2 References

For related documents and software, please visit:

<https://www.dialog-semiconductor.com/configurable-mixed-signal>.

Download our free [GreenPAK Designer](#) software [1] to open the .gp file [2] and view the proposed circuit design. Use the [GreenPAK development tools](#) [3] to freeze the design into your own customized IC in a matter of minutes. Find out more in a complete library of application notes [4] featuring design examples, as well as explanations of features and blocks within the GreenPAK IC.

- [1] [GreenPAK Designer Software](#), Software Download and User Guide
- [2] [AN-CM-315 High Voltage Zero-Crossing Relay Driver.gp](#), GreenPAK Design File
- [3] [GreenPAK Development Tools](#), GreenPAK Development Tools Webpage
- [4] [GreenPAK Application Notes](#), GreenPAK Application Notes Webpage
- [5] [AN-1210 Zero Crossing Detector](#), Application Note
- [6] [G5NB](#), Datasheet, OMRON Corporation
- [7] [SLG47105](#), Datasheet, Revision 3.0

Author: Gino Castillo

This article was originally published on [Electronic Design](#).

High Voltage Zero-Crossing Relay Driver

3 Introduction

A relay is a device that allows for a smaller electronic switch to control a larger mechanical switch opening and closing a contact terminal with electrical isolation between the two. They are found everywhere, from refrigerators to elevators to amplifiers to smart meters. Since most relays involve an AC load, arcing and extra power loss at switching can be a concern if the relay opens and closes the contacts while the AC signal is around its peak. This can be prevented by only switching while the AC signal crosses zero volts, or at zero-crossing. A GreenPAK can be configured to control a relay and time its switching at zero-crossing.

4 What is a Relay?

A relay consists of two isolated circuits: a controlling "primary" circuit and the controlled "secondary" circuit.

The primary circuit commonly involves a transistor that controls an electromagnetic coil to pull or push a mechanical armature on the secondary circuit with its electromagnetic field. It is often powered by a smaller DC voltage supply.

The secondary circuit has the contact terminal that is opened and closed by the armature. It often involves an AC load, such as a fan, light, amplifier circuit, or a smart meter.

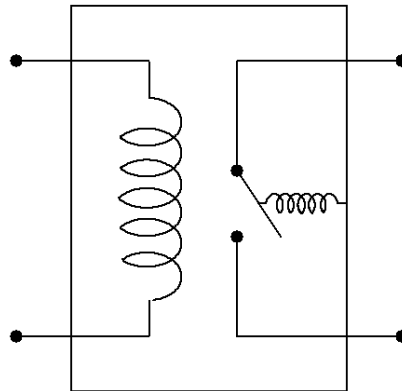

Figure 1: Sketch of A Relay

5 Zero Voltage Switching

Zero voltage switching (ZVS) aims to change the state of a relay or electronic switch at the moment there is no significant voltage across the switching element. At this moment, there should also be no significant conducted current. This helps to minimize wear on the mechanical contact and reduces the risk of inductive kickbacks of inductive loads. In this application, the zero-voltage transition point of an AC power path is measured and the signal is converted into a manageable DC square wave. This DC square wave will signal the GreenPAK to close the armature when there is a zero-crossing condition.

ZVS can also be used for measuring the frequency or phase of an AC signal. We will use this aspect of ZVS to only turn on the coil when a 60Hz AC power is being supplied to the secondary circuit with a frequency detector in GreenPAK.

There are multiple ways to implement a zero-crossing voltage detector (ZCVD) circuit that will provide ZVS. A focused explanation of using the GreenPAK for ZVS is found in AN-1210 [5] (in this

High Voltage Zero-Crossing Relay Driver

app note, ZVS is referred to as ZVCD). This design will use a low power ZCVD that consists of a half wave rectifier that feeds into a 4N25 optocoupler shown below.

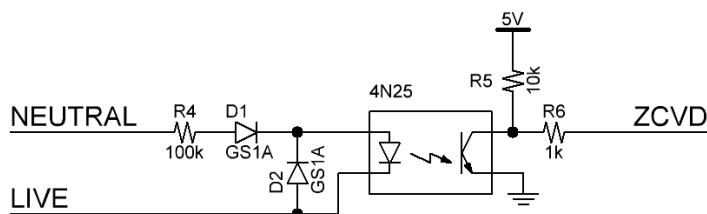

Figure 2: Zero-Crossing Voltage Detector Circuit

In the optocoupler, the rectified AC signal turns on an LED inside that will emit light with an intensity proportional to the input signal to a phototransistor also inside. When the light reaches a certain threshold, the phototransistor will turn ON. The output of the optocoupler is a DC output at a level manageable for a digital input.

6 External Circuit

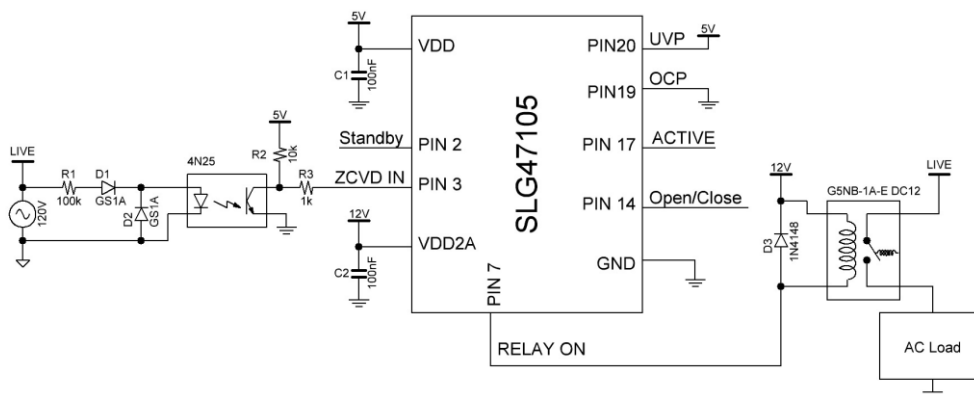

Figure 3: External Circuit Schematic

RELAY ON (PIN7) is connected to the low side of a relay. A G5NB-1A-E DC12 relay was used for this application note. While RELAY ON is HIGH, the armature will open and break the connection between the electrical outlet and the AC load. When RELAY ON goes LOW, the armature will close the connection between the electrical outlet and the AC load. A flywheel 1N4148 diode is added between the poles of the coil to dissipate the back EMF from the coil safely. The operating time of the relay must also be compensated for by the GreenPAK if it is to be closed at the true zero-crossing moment. The maximum operation time for the relay is rated as 10ms in its datasheet [6].

Two Agilent DC power supplies were used to supply voltage to the circuit, but a regulated voltage supply (such as using a diode ring and regulator IC) could be used to supply the 12V and 5V for the GreenPAK from a power outlet.

The ZCVD circuit is added externally between the AC input and **ZCVD IN** (PIN3). The output of the optocoupler has a slight delay after the true zero crossing moment and must be compensated within the GreenPAK. The measured delay of the optocoupler was 740 μ s, which does not account for the input hysteresis. The graphs below were from a simulated test of a 50Hz input signal and the optocoupler output to estimate this delay. $V_{IHmin} = 0.5 \times VDD$ and $V_{ILmax} = 0.3 \times VDD$. With a VDD of 3V, the values are $V_{IHmin} = 1.5V$ and $V_{ILmax} = 0.9V$. The offset we are concerned with most is the delay between the true zero-crossing and V_{IHmin} (1.5V) which is shown in Figure 6 to be about 550 μ s.

High Voltage Zero-Crossing Relay Driver

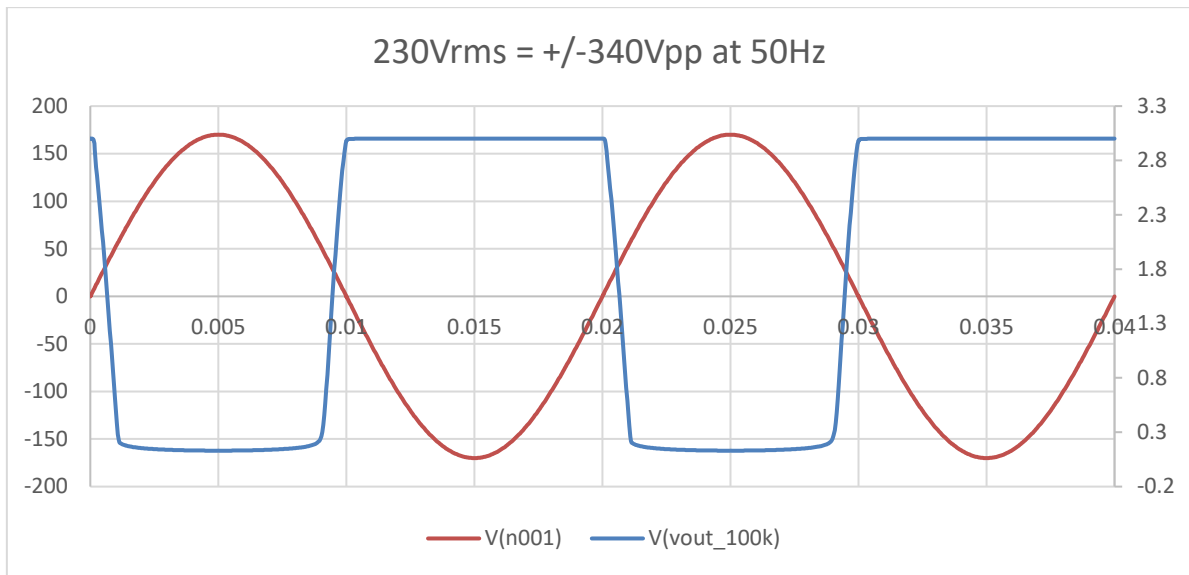

Figure 4: Simulation Results

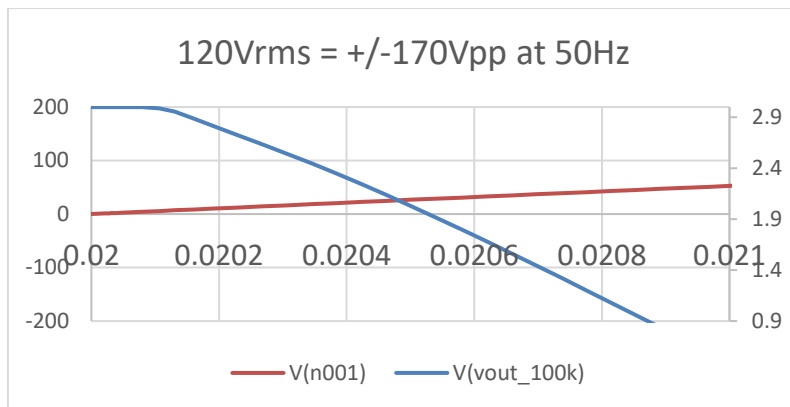

Figure 5: Rising AC Edge Detection

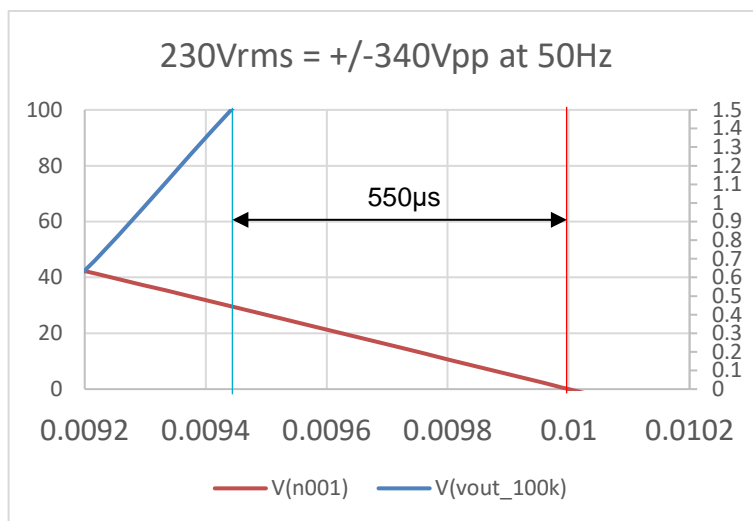

Figure 6: Falling AC Edge Detection

High Voltage Zero-Crossing Relay Driver

7 GreenPAK Design

For this application, we selected the SLG47105 [3] GreenPAK. This GreenPAK device has four high voltage outputs available that can go up to 13.2V, so with it we are able to control a 12V coil. The HV OUT CTRL0 is set to the "Half bridge" HV OUT mode and keep the slew rate set to the default "slow for motor driver." PIN7 is set to "LOW side on" so that when it is activated it will pull down the low side of the relay to ground and turn on the relay.

4-bit LUT0 is connected to the nRST of DFF3 and the OE of HV OUT CTRL0. The LUT is configured to go HIGH when **ARM Relay** (PIN2) is HIGH, a signal with a frequency faster than 55Hz is sent to ZCVD IN, the overcurrent ACMP is below the threshold, and the undervoltage ACMP is above the threshold. When 4-bit LUT0 goes HIGH it will activate the relay driver operation and **ACTIVE** (PIN17) will flag HIGH. The OCP and UVP inputs can be connected by a resistor divider to the load, supply, or another monitored IC and the ACMP thresholds set to the correct value. In testing, OCP was connected to GND and UVP to VDD to remove their function from the circuit.

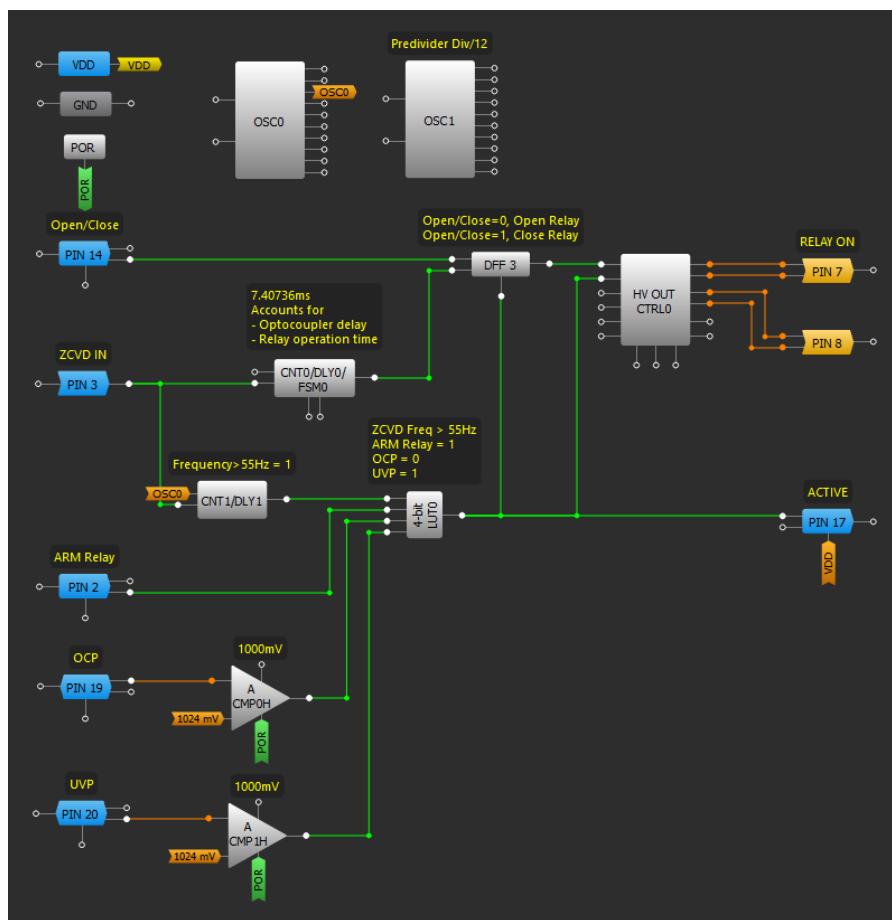

Figure 7: View of GreenPAK Design

Open/Close (PIN14) is connected to the D of DFF3 and the delayed ZCVD IN input is connected to its CLK. The nQ output of DFF3 is connected to IN0 of HV OUT CTRL0. When the DFF is activated, it will check the state of Open/Close. If there is a HIGH on Open/Close the GreenPAK will signal to close the relay at a future zero-crossing of the AC line, and a LOW will signal to open the relay.

The rising edge DLY0 after ZCVD IN was set to about 7.407ms to correct the 740 μ s ZCVD delay that was measured and 10ms max operating time of the relay for the armature to close at true zero-crossing. This was determined because the next zero crossing greater than 10ms is 16.667ms (period of 60Hz) and the total offset to true zero crossing (operating time minus ZCVD delay) is

High Voltage Zero-Crossing Relay Driver

9.26ms. Using the below formula, the value was calculated to be 7.407ms. This delay can be altered to account for a different operating time.

$$\text{Eq. 1: } \quad \text{Total Offset} = \text{Period to Next Zero Crossing} - (\text{Operating Time} - \text{ZCVD Delay})$$

8 Test

- Channel 1 (yellow) - ZCVD IN (to GreenPAK)
- Channel 2 (light blue) - RELAY ON (driver output)
- Channel 3 (pink) - Electrical Outlet Signal
- Channel 4 (blue) - Relay Contact



Figure 8: Relay Does Not Close at True Zero-Crossing with 7.407ms Delay

The circuit was tested at no load with the 7.407ms delay, but as shown above in [Figure 5](#), the relay did not switch at true zero crossing (when the electrical outlet signal is at zero). To correct this, the actual operation time of the relay was measured by observing the distance between RELAY ON going Low and the relay contact settling to the same value as the electrical outlet signal. This was measured to be 4.16ms as seen below in [Figure 6](#).

High Voltage Zero-Crossing Relay Driver

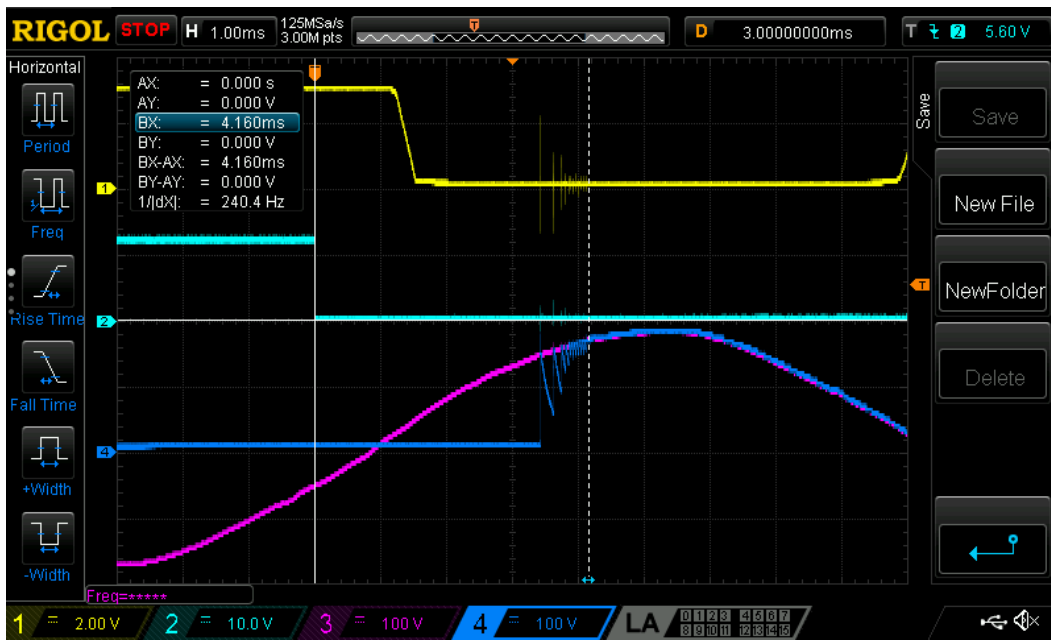

Figure 9: Measurement of the actual operation time of the relay

Using Eq. 1, the corrected delay was calculated as 4.793ms. The next zero crossing after the operating time was the half period of the power outlet (8.333ms). The delay value of DLY0 was easily changed to reflect this in GreenPAK Designer by changing the counter value. When the circuit was retested with this new delay value, the relay switched at true zero-crossing at opening and closing, as shown below in Figures 7 and 8.

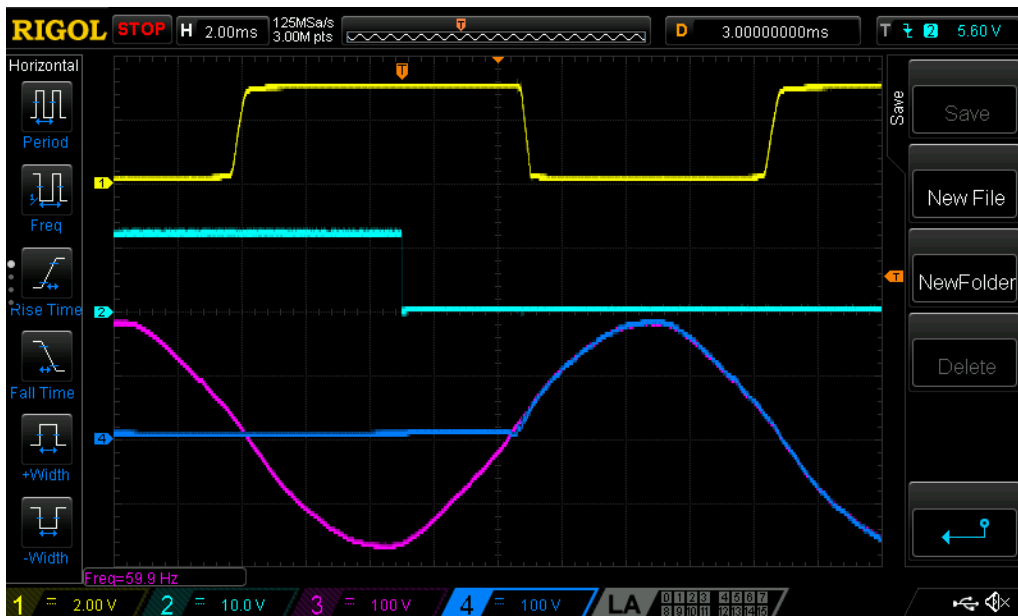

Figure 10: Relay closing at true zero-crossing with 4.793ms delay

High Voltage Zero-Crossing Relay Driver

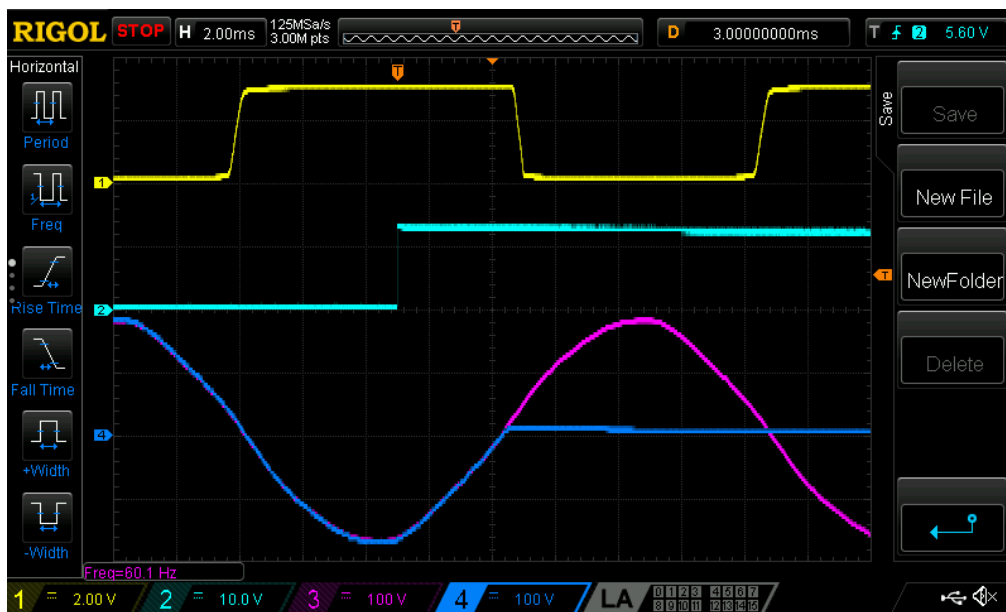

Figure 11: Relay opening at true zero-crossing with 4.793ms delay

9 Conclusion

With some external circuitry and the correct delay, the SLG47105 was able to drive the 12V relay at true zero-crossing. The circuit was tested at no load, so further adjustments can be made to fit its functionality with the intended load. The extra available logic allows for additional functionality to be integrated with the GreenPAK. Among the wide variety of applications, the GreenPAK can achieve, it can provide a configurable relay driver that switches at true zero-crossing for safer and more efficient operation.

High Voltage Zero-Crossing Relay Driver

Revision History

Revision	Date	Description
1.0	15-Sept-2021	Initial version.