

RA/RX Family

QE for Motor Application Development Guide

Introduction

This application note describes how to use the motor software development support tool (QE for Motor) to install and verify motor control software.

Evaluation Kit to Be Operated

RA family : MCK-RA6T2 Renesas Flexible Motor Control Kit for RA6T2 MCU Group

RX family : MCK-RX26T Renesas Flexible Motor Control Kit for RX26T MCU Group

Contents

1. Overview	3
1.1 System Overview.....	3
1.2 Operating Environment	4
1.3 Reference Documents.....	5
2. Preparation.....	6
2.1 Installation of QE for Motor.....	6
2.2 Installation of Renesas Motor Workbench	9
2.3 Board Connection.....	10
2.3.1 Connection when downloading a program.....	10
2.3.2 Connection when tuning or analyzing the motor operation.....	12
3. Development Procedure	14
4. Operation Example	15
4.1 Preparation	15
4.1.1 Start QE for Motor	15
4.1.2 Project Selection.....	16
4.1.2.1 Import of the project	16
4.1.2.2 Target Project Selection	19
4.1.3 Motor Software Configuration.....	20
4.1.3.1 Software Configuration for RA Family.....	20
4.1.3.2 Software Configuration for RX Family.....	24
4.1.4 Tool Settings.....	31
4.1.4.1 Install Renesas Motor Workbench	31
4.1.4.2 Configure Renesas Motor Workbench path.....	32
4.2 Tuning.....	33
4.2.1 Prepare Tuning Program.....	33
4.2.2 Download Tuning Program.....	34
4.2.3 Start Tuner.....	35
4.2.3.1 Installation of VCP driver.....	36
4.2.3.2 Start Tuning.....	38
4.2.3.3 Waveform Confirmation.....	39
4.2.3.4 Output Header File	40
4.3 Analyze.....	41
4.3.1 Build Application Program	41
4.3.2 Download Application Program	42
4.3.3 Start Analyzer	43
4.3.3.1 Start to Analyze	44
5. Output Files	46
6. Help and Guide Function	47
Revision History.....	48

1. Overview

1.1 System Overview

QE for Motor is a software development tool for motors that allows you to develop motor control software simply by following the workflow. QE for motor support your entire development process from the implementation of motor control software to validation.

The main functions of QE for Motor are as follows.

- **Workflow view**
By following the workflow, you can configure the middleware and driver software for motor control, and tune and analyze in conjunction with Renesas Motor Workbench.
- **Motor Software Configuration View**
The parameters in motor middleware and driver can be configured on GUI.
- **Linkage with Renesas Motor Workbench**
It works in conjunction with Renesas Motor Workbench for motor tuning and analysis. Since the settings required for Renesas Motor Workbench are automated, you can use these functions simply by pressing a button in the workflow view.

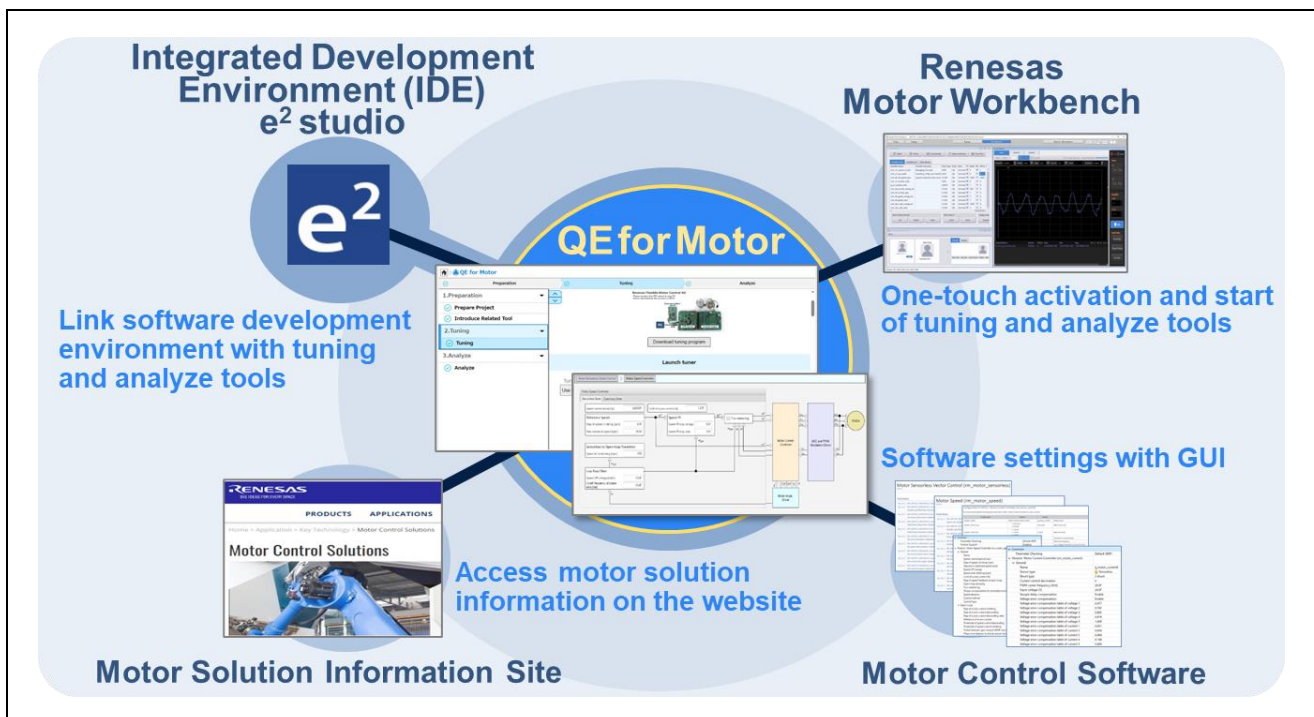

Figure 1-1 Integrated development environment with QE for Motor

1.2 Operating Environment

The operating environment of this development guide is as shown in Table 1-1 and Figure 1-2.

Table 1-1 Operating Environment

Items	Contents
PC OS	x64 based processor Windows® 10 (64-bit), Windows® 11
IDE	e² studio version 2023-07 or later Flexible Software Package (FSP) v4.4.0 Renesas Motor Workbench V3.1.2
Tool chain	GNU Arm Embedded Toolchain: 10.3-2021.10 or later (GNU ARM Embedded 10.3.1.20210824)
QE for Motor	V1.3.0
Renesas Motor Workbench	V.1.3.2
Corresponding MCU	RA Family : RA6 Series RA6T2 RX Family : RX200 Series RX26T
Evaluation Board	RA Family : MCK-RA6T2 Renesas Flexible Motor Control Kit for RA6T2 MCU Group [RTK0EMA270S00020BJ] RX Family : MCK-RX26T Renesas Flexible Motor Control Kit for RX26T MCU Group [RTK0EMXE70S00020BJ]
Sample Program	RA Family : Sensorless Vector Control for Permanent Magnet Synchronous Motor (RA6T2_MCILV1_SPM_LESS_FOC_E2S_Vxxx) [R01AN6839] RX Family : Sensorless Vector Control for Permanent Magnet Synchronous Motor (For RX26T RAM64KB Version) (RX26T_MCBA_MCILV1_SPM_LESS_FOC_E2S_Vxxx) [R01AN6858]

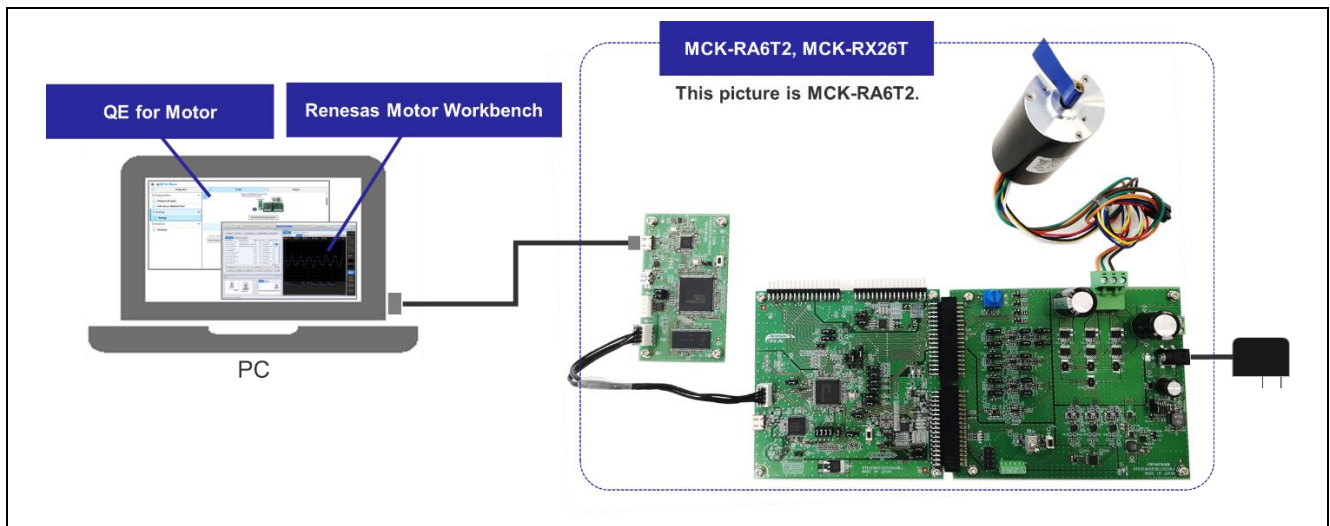

Figure 1-2 Operating Environment

1.3 Reference Documents

- R01UH0951 RA6T2 Group User's Manual: Hardware
- R12UZ0091 MCK-RA6T2 User's Manual
- R01UH0979 RX26T Group User's Manual: Hardware
- R12UZ0111 MCK-RX26T User's Manual
- R21UZ0004 Motor Control Development Support Tool Renesas Motor Workbench 3.1.2 User's Manual
- R21QS0011 Motor Control Development Support Tool Renesas Motor Workbench 3.1.2 Quick Start Guide
- R01AN6839 RA6T2 Sensorless vector control for permanent magnetic synchronous motor
- R01AN6858 RX26T Sensorless vector control for permanent magnetic synchronous motor

2. Preparation

The preparations required to control the motor with QE for Motor are as follows.

- Install e² studio
- Apply the following tools to e² studio
 - Configuration tool
 - Tool chain
 - QE for Motor
- Install Renesas Motor Workbench
- Connect to the board

This chapter describes the installation of QE for Motor and Renesas Motor Workbench, and the board connection.

2.1 Installation of QE for Motor

This section describes how to install QE from Renesas Software Installer of e² studio.

Select Renesas Software Installer from the e² studio menu. After the Renesas Software Installer window appears, select “Renesas QE” and click “Next”.

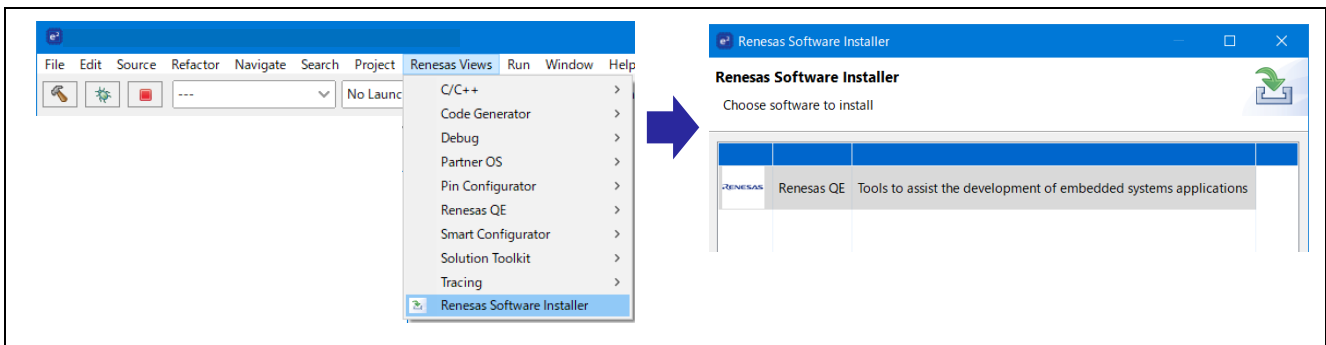

Figure 2-1 Renesas Software Installer

When “Install Extensions” is displayed, check “QE for Motor” and click “Finish”.

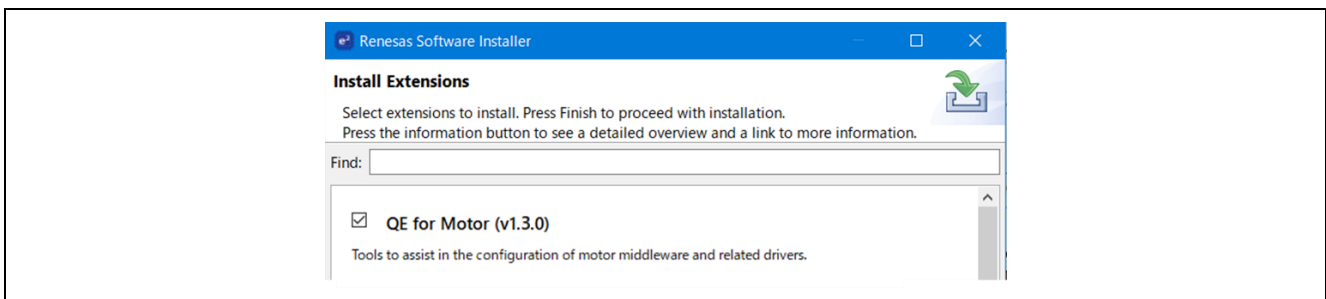

Figure 2-2 Install Extensions

Check “Renesas QE for Motor” for the item you want to install, and click “Next”.

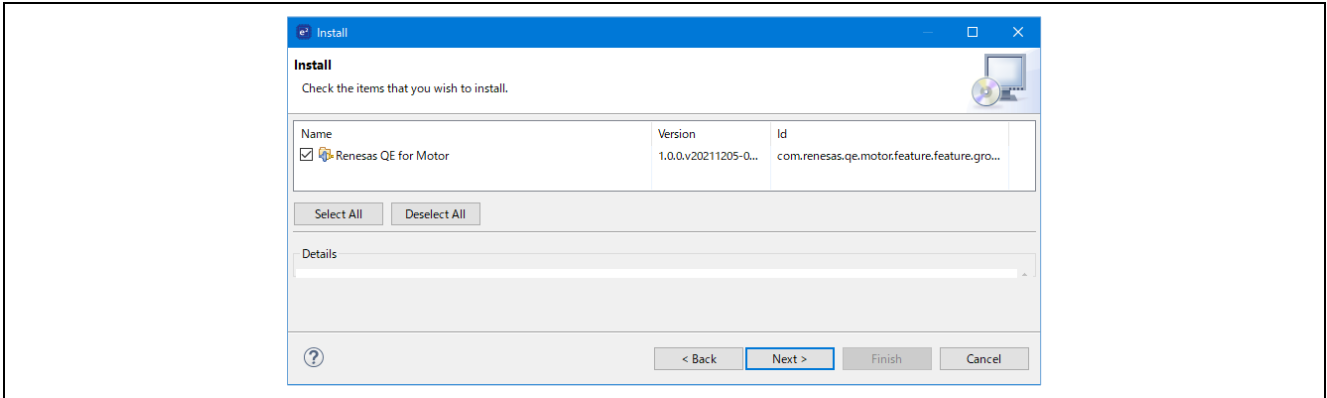

Figure 2-3 QE installation

In case that the following window appears, set it as a trusted tool. Then the installation will be executed.

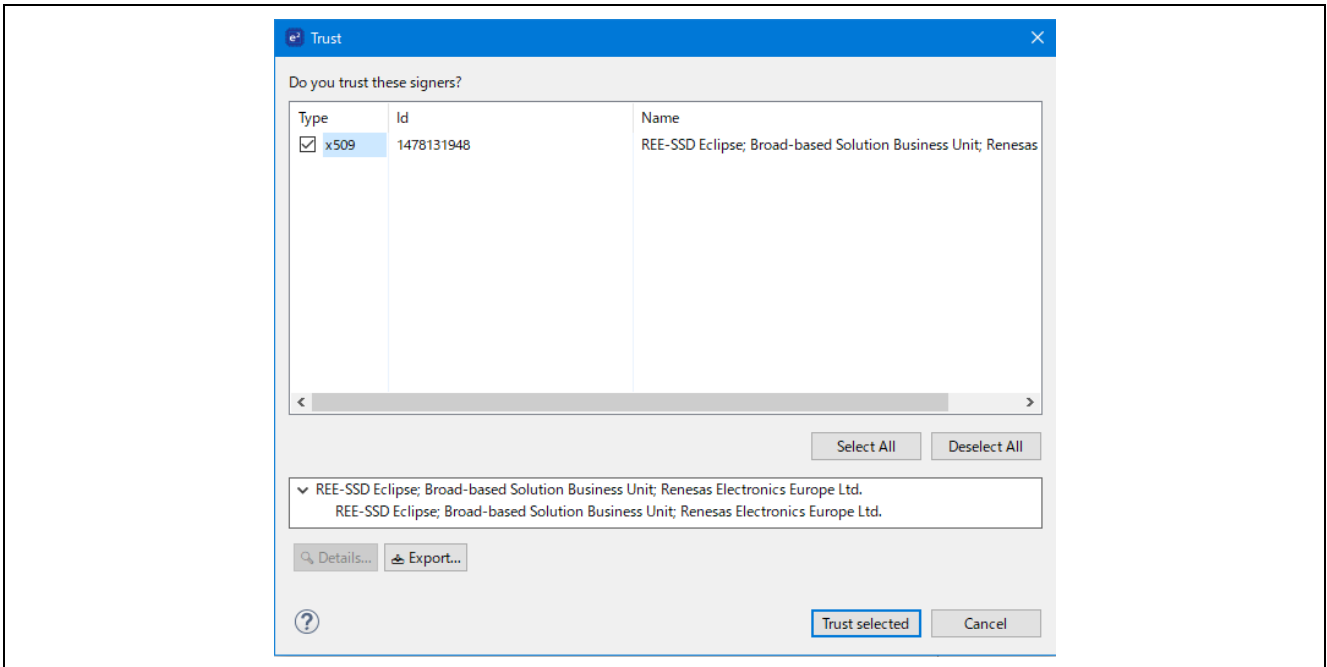

Figure 2-4 Trusted tool

The installation status of QE for Motor is displayed at the bottom right of e² studio. Installation is complete when you restart e² studio.

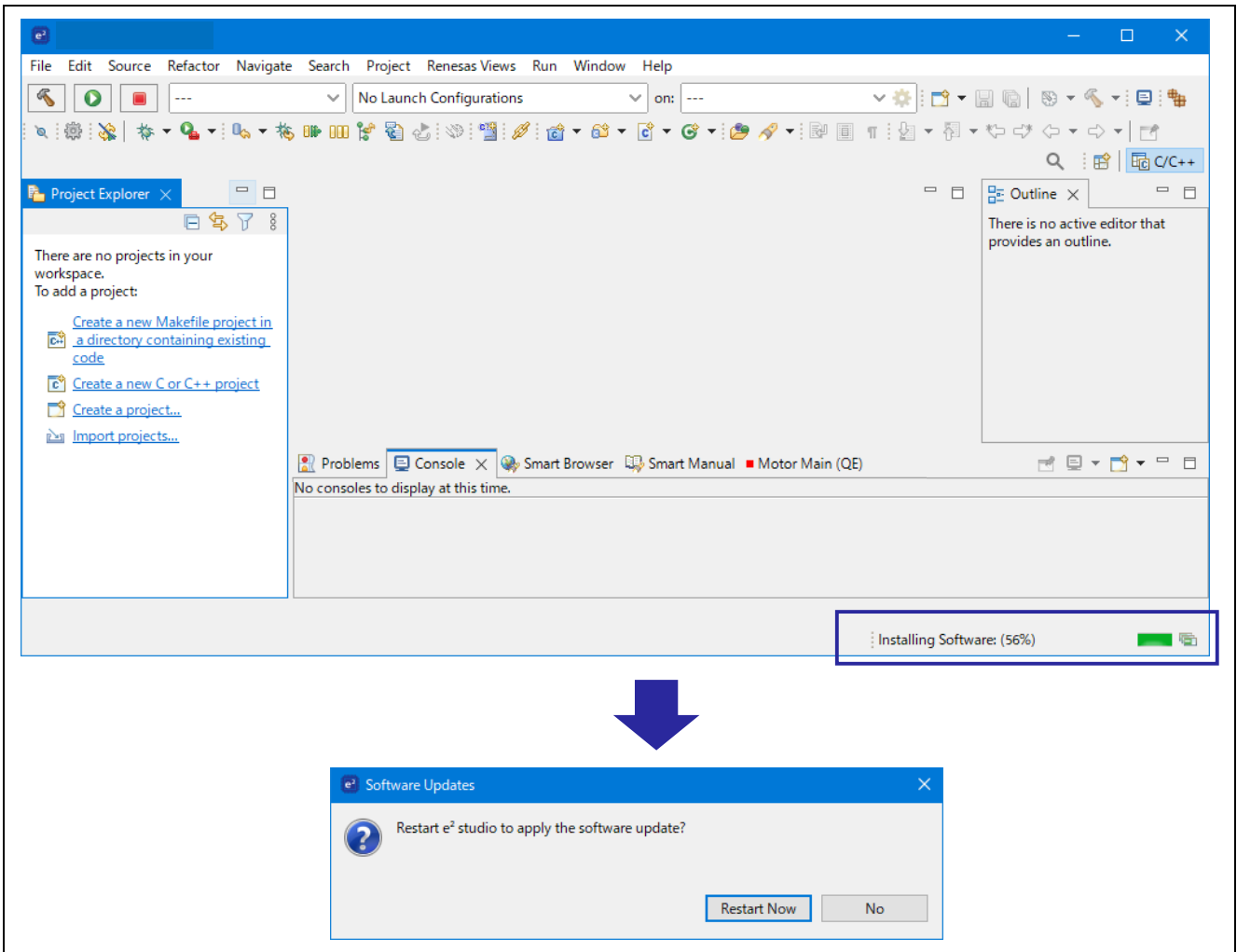

Figure 2-5 Installation Status

2.2 Installation of Renesas Motor Workbench

The tuning and the analyzer functions use Motor Control Development Support Tool Renesas Motor Workbench. The Renesas Motor Workbench needs to be installed to use these functions. There are two methods to install the Renesas Motor Workbench.

(1) Install from QE for Motor Workflow

The Renesas Motor Workbench can also be downloaded and installed from QE for Motor view. Refer to “4.1.4.1 Install Renesas Motor Workbench” for how to install Renesas Motor Workbench from QE for Motor workflow view.

(2) Download the installer manually

Download “Renesas Motor Workbench” package file from the Renesas website.

Unzip the package file, and execute “renesas_motor_workbench_***.msi” under the installer folder, and install as shown in the below figure.

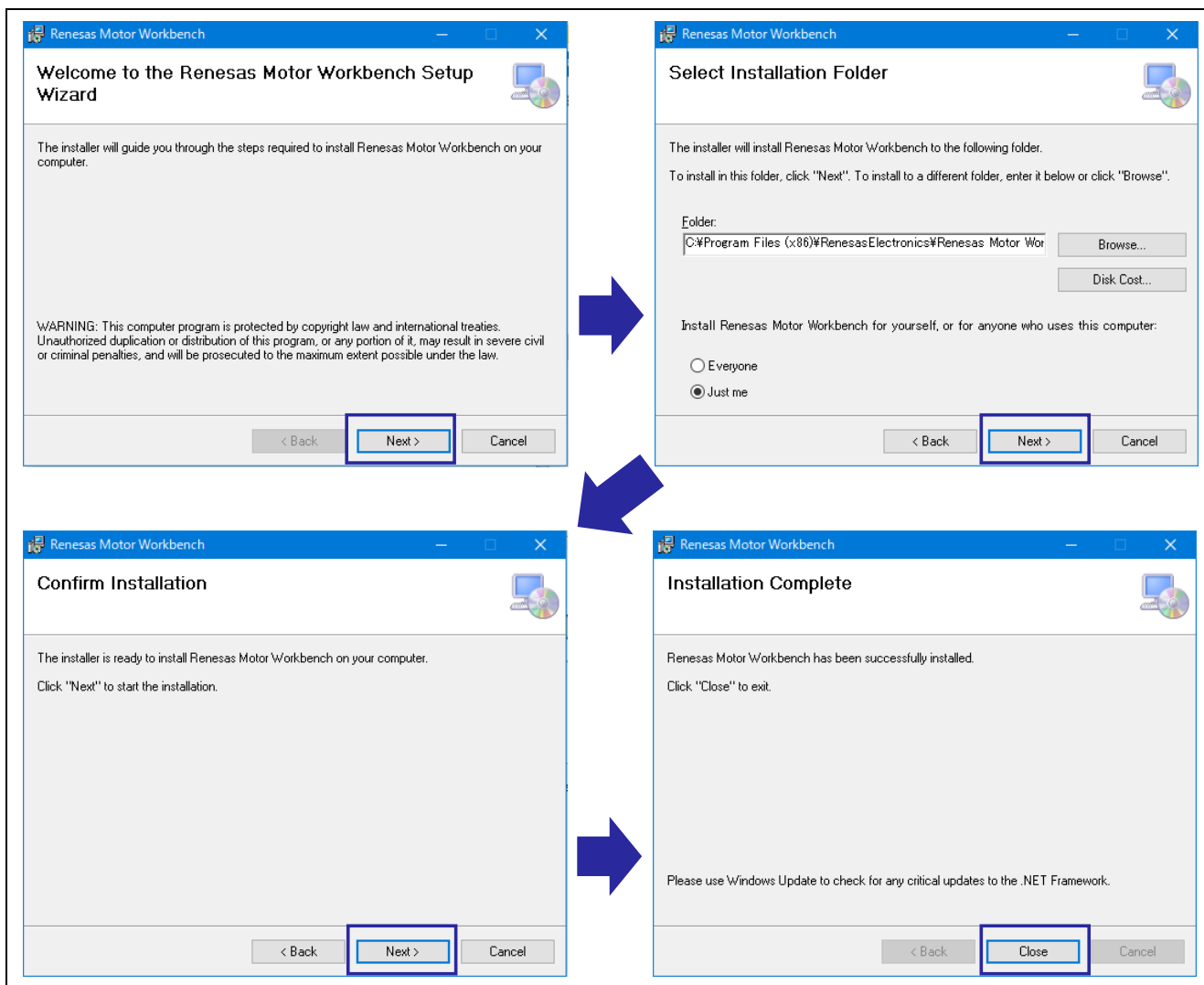

Figure 2-6 Installation of Renesas Motor Workbench

2.3 Board Connection

This section explains how to connect the PC and the evaluation board. The connection method differs between when downloading the program and when tuning or analyzing the motor operation.

2.3.1 Connection when downloading a program

Figure 2-7 shows the connection diagram when downloading the program. The connection of peripherals other than CPU board does not affect the program downloading.

- MCK-RA6T2

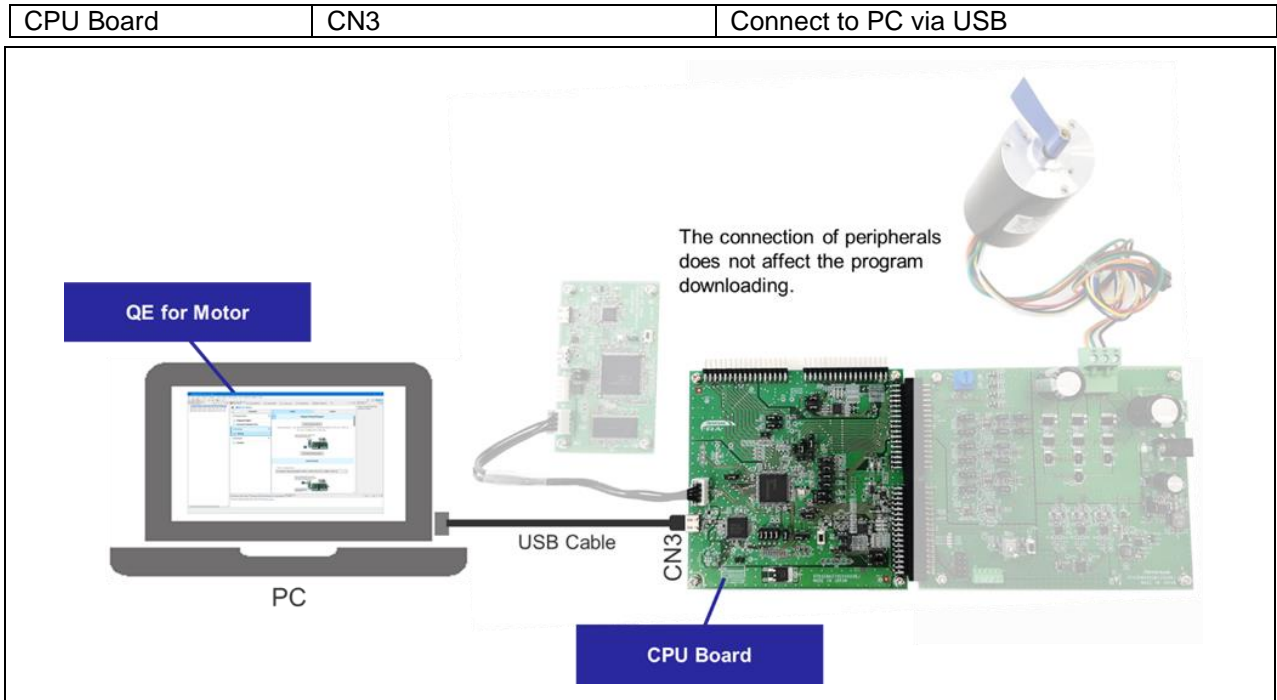

Figure 2-7-1 Connection diagram when downloading a program (MCK-RA6T2)

• MCK-RX26T

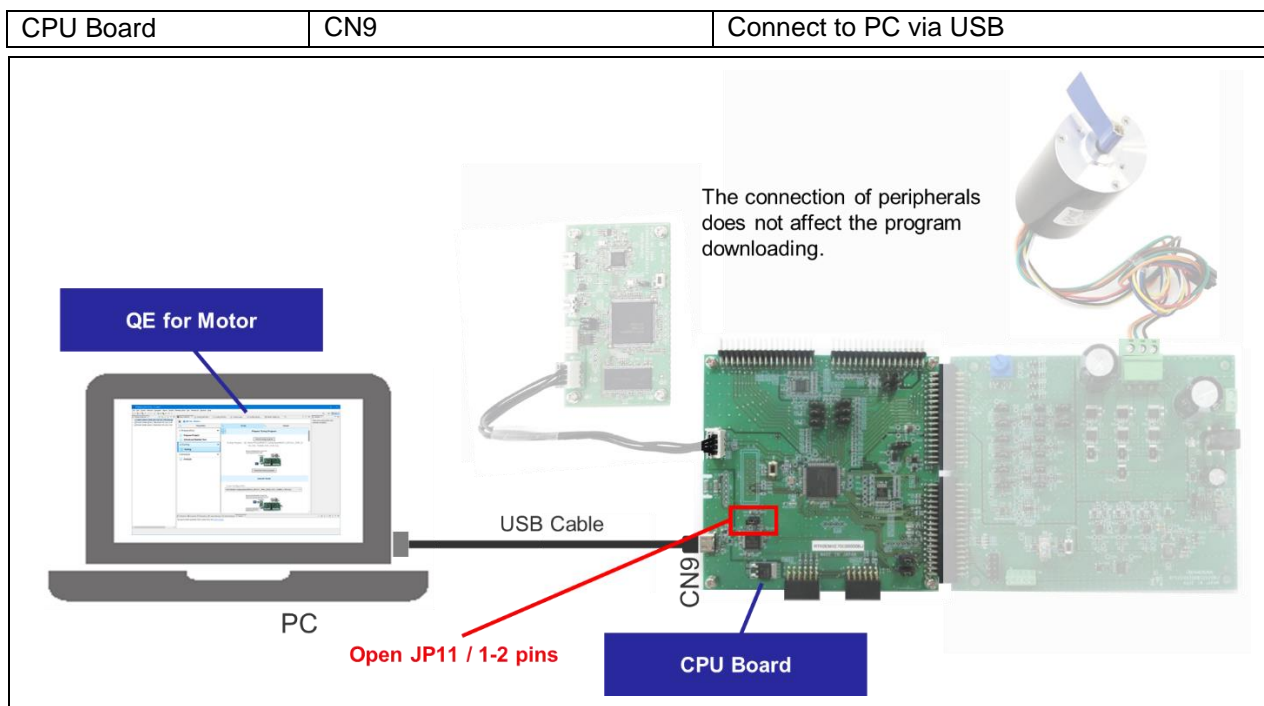

Figure 2-7-2 Connection diagram when downloading a program (MCK-RX26T)

This connection is used in the following operations.

- Download the tuning program to the MCU
- Download the application for analysis to the MCU

2.3.2 Connection when tuning or analyzing the motor operation

Figure 2-8 shows the connection diagram for tuning or analyzing the motor operation.

- MCK-RA6T2

Communication Board	CN3	Connect to PC via USB
	CN5	Connect to CPU Board with communication cable
CPU Board	CN10	Connect to Communication Board with communication cable
	CN4,CN5	Connect to Inverter Board
Inverter Board	CN3,CN4	Connect to CPU Board
	CN2	Connect to brushless DC motor
	J1 or CN1	Use J1 when supplying power from the DC jack Use CN1 when supplying power from the power supply connector

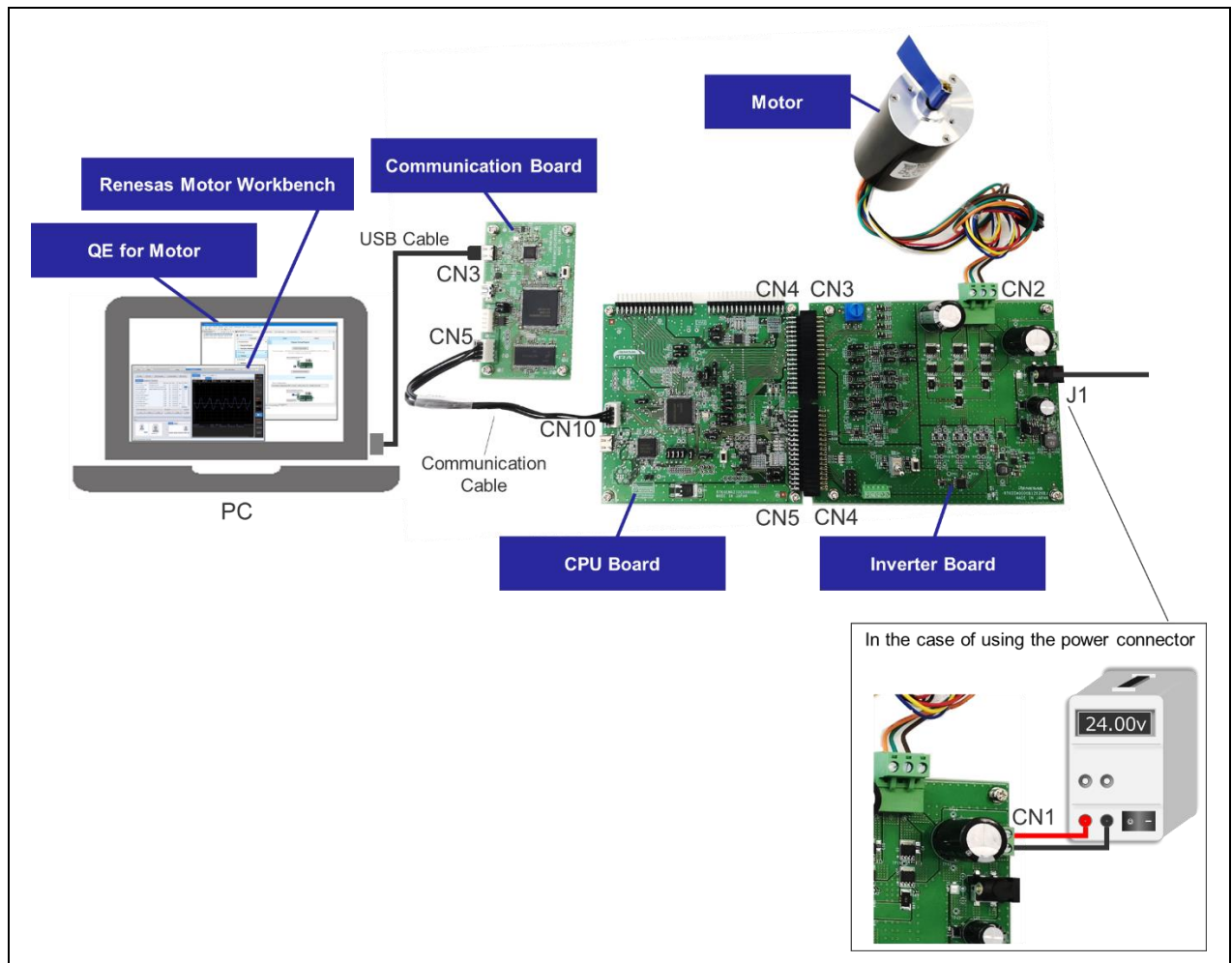

Figure 2-8-1 Connection diagram when analyzing the motor operation (MCK-RA6T2)

• MCK-RX26T

Communication Board	CN3	Connect to PC via USB
	CN5	Connect to CPU Board with communication cable
CPU Board	CN6	Connect to Communication Board with communication cable
	CN1,CN2	Connect to Inverter Board
Inverter Board	CN3,CN4	Connect to CPU Board
	CN2	Connect to brushless DC motor
	J1 or CN1	Use J1 when supplying power from the DC jack Use CN1 when supplying power from the power supply connector

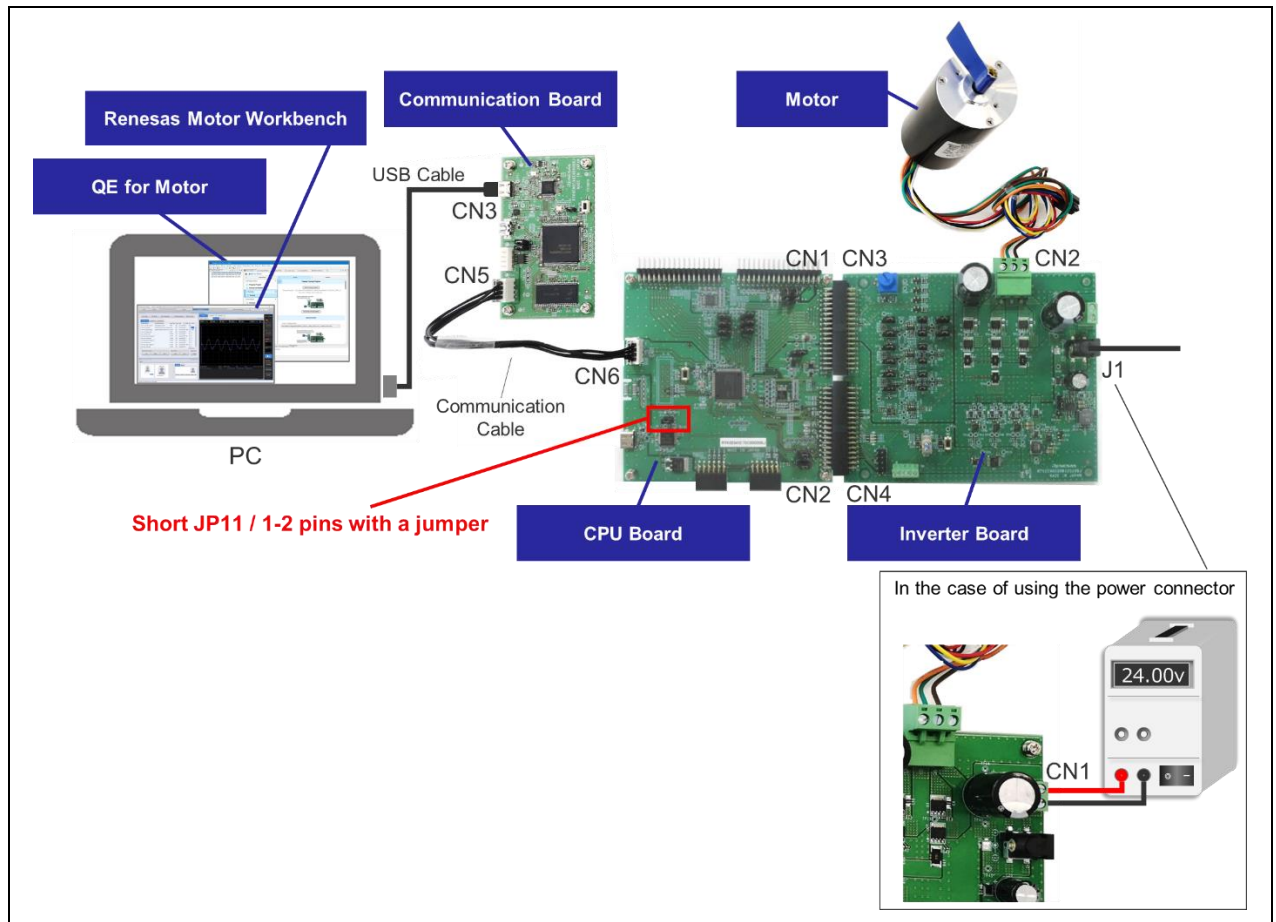

Figure 2-8-2 Connection diagram when analyzing the motor operation (MCK-RX26T)

This connection is used in the following operations.

- Tuning by starting tuner
- Analyzing the motor control by starting analyzer

3. Development Procedure

By operating according to the workflow of QE for Motor, you can implement and validate the motor control software.

Each item is show in Table 3-1. The chapter number in this table are linked to related chapters. Click the chapter number to see how to use it.

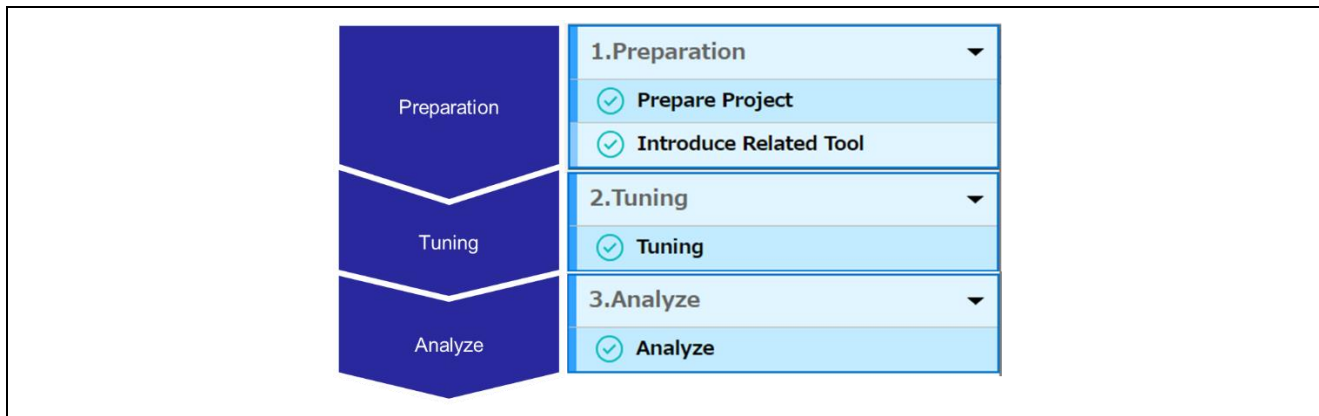

Figure 3-1 Development procedure of motor control software

Table 3-1 The items of QE for Motor

Items		Contents	Chapter number
Preparation	Select Target Project	Prepare the project and set it as the target project	4.1.2
	Configure Motor Software	Configure the motor control software with FSP	4.1.3
	Configure Tool	Set the path of Renesas Motor Workbench	4.1.4
Tuning	Prepare Tuning Program	Copy the tuning program for the motor to be used from Renesas Motor Workbench install folder	4.2.1
	Download Tuning Program	Download tuning program to MCU	4.2.2
	Start Tuner	Start tuner function of Renesas Motor Workbench and output the tuning result to the header files.	4.2.3
Analyze	Build Application Program	Build the program	4.3.1
	Download Application Program	Download the built program to MCU	4.3.2
	Start Analyzer	Start Analyzer function of Renesas Motor Workbench and analyze the motor operation	4.3.3

4. Operation Example

Renesas website offers a variety of motor control sample projects.

This chapter describes the procedure for tuning and analyzing using QE for Motor. The following sample project is used in this chapter.

- RA Family :
RA6T2 Sensorless vector control for permanent magnetic synchronous motor (R01AN6839)
- RX Family :
RX26T RAM64KB Version Sensorless vector control for permanent magnetic synchronous motor (R01AN6858)

For details on the sample project, refer to the application note included in each sample program.

4.1 Preparation

Start e² studio. Create the workspace so that the folder name does not include space.

Example :

- C:¥workSpace - Good
- C:¥work Space - Not Good

4.1.1 Start QE for Motor

Select Motor Workflow (QE) from the e² studio menu as shown below to display Motor Workflow view of QE for Motor.

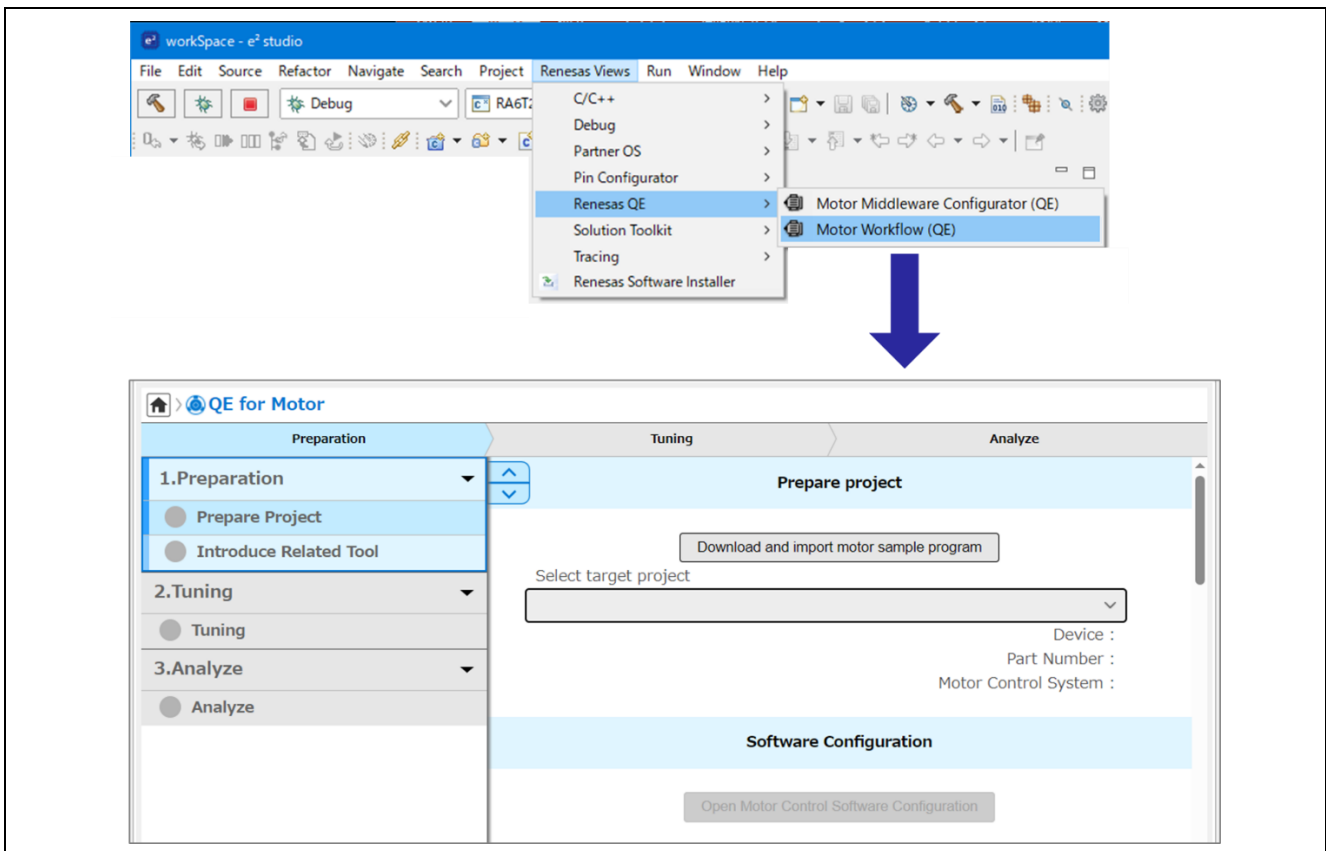

Figure 4-1 Selection of Motor Workflow (QE)

4.1.2 Project Selection

4.1.2.1 Import of the project

Download the sample project from Renesas web site and import that into e²studio workspace as shown below.

Select "Prepare Project"

Click "Download and import motor sample program" button.

The screenshot shows the 'QE for Motor' software interface. On the left, a sidebar lists three main steps: '1. Preparation', '2. Tuning', and '3. Analyze'. Under '1. Preparation', 'Prepare Project' is selected. A blue arrow points from this selection to a button labeled 'Download and import motor sample program' in the main workspace. Below this button is a 'Select target project' dropdown menu and fields for 'Device', 'Part Number', and 'Motor Control System'. A second blue arrow points from the button down to a 'Region Setting' dialog box. This dialog box has a title bar with a close button and contains the text 'Select your region.' followed by a dropdown menu. The dropdown menu is open, showing a list of regions: Americas, Brazil, Europe/Middle East/Africa, India, Japan, Mainland China/Hong Kong Region, Singapore/South & Southeast Asia/Oceania, South Korea, and Taiwan Region. A third blue arrow points from the bottom of the dialog box down towards the next step.

Select the region of the download site for the first time.

Select a project to import.

MCK-RA6T2

Select Kits tab

Select MCK-RA6T2

Select Sensorless Vector Control for Permanent Magnet Synchronous Motor (RA6T2_MCILV1_SPM_LESS_FOC_E2S_Vxxx)

Specify the location of downloaded files (Any folder)

Click OK

MCK-RX26T

Select Kits tab

Select MCK-RX26T

Select Sensorless Vector Control of a Permanent Magnet Synchronous Motor - For MCK (for RX26T_MCBA_MCILV1_SPM_LESS_FOC_E2S_V110)

Specify the location of downloaded files (Any folder)

Click OK

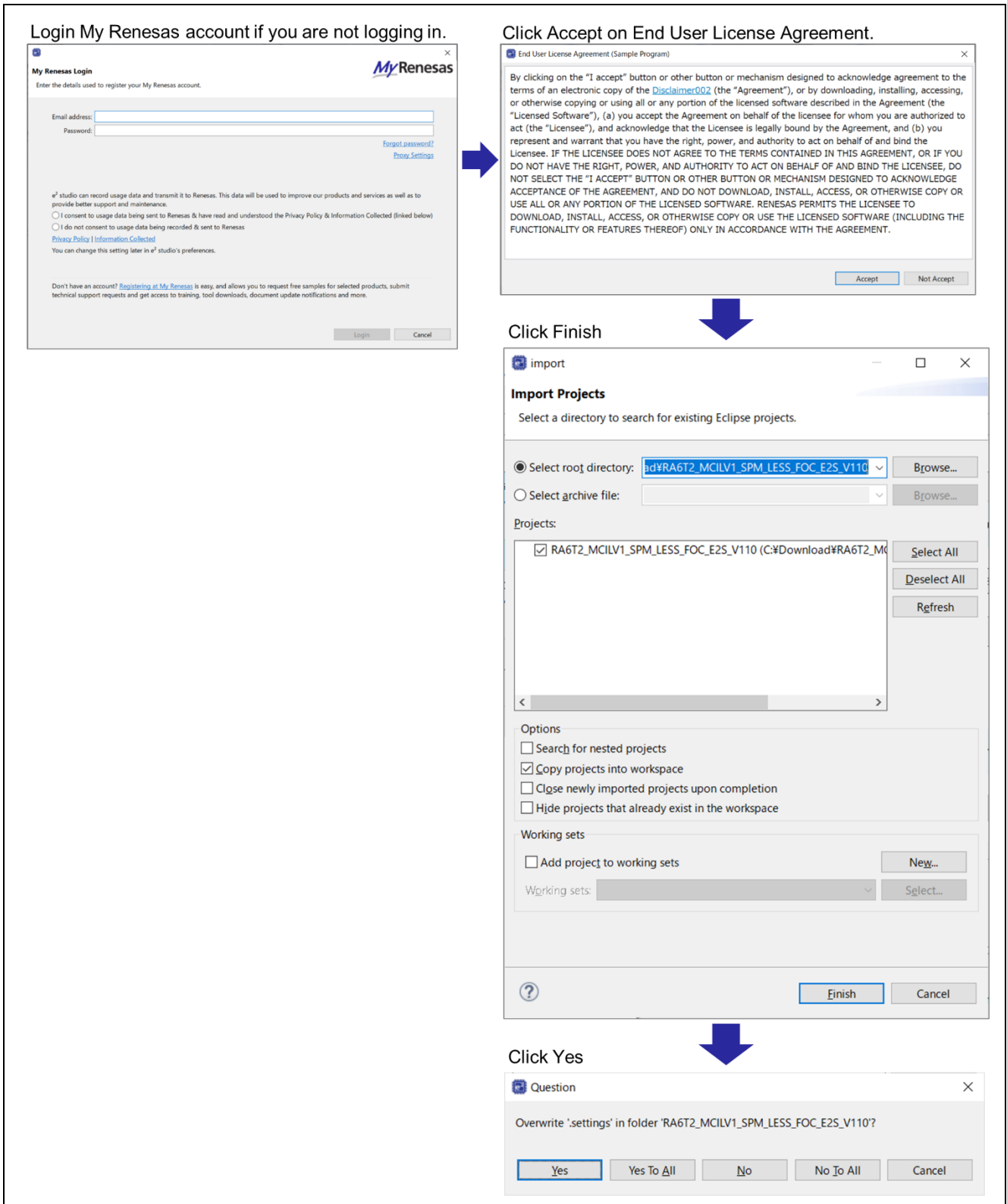

Figure 4-2 Project import

4.1.2.2 Target Project Selection

Select the imported project as the target project as shown in the figure below.

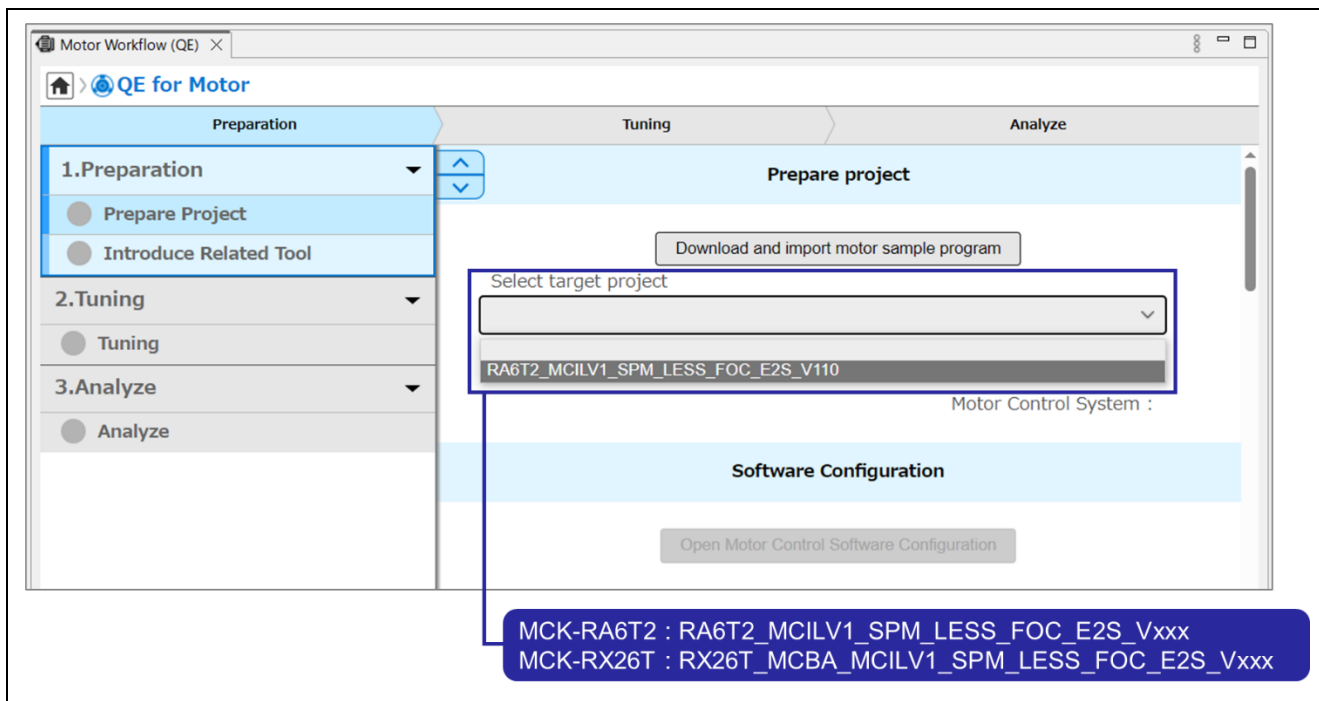

Figure 4-3 Target project selection

4.1.3 Motor Software Configuration

The sample project does not need to be changed because the required software settings have already been made. This chapter describes how to check and change the software settings when the setting needs to be changed by a change in the board configuration or other reasons.

4.1.3.1 Software Configuration for RA Family

The sample project was created with a certain version of FSP. If FSP version you are using is different, perform the code generation in (3) even if you do not change the settings.

(1) Viewing FSP Configuration

Click “Start Configuration” of “Configure Motor Software” as shown below to display the FSP Configuration window.

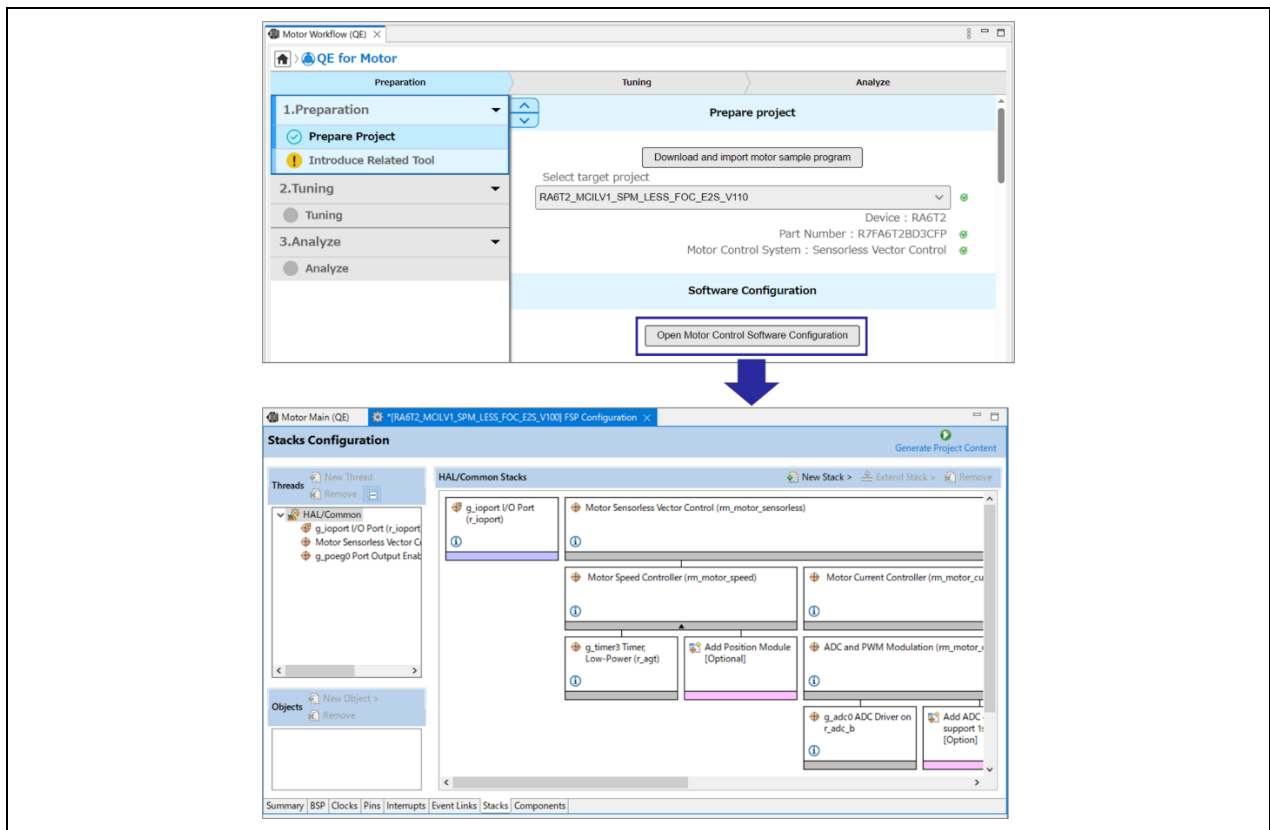

Figure 4-4 FSP Configuration View

(2) Viewing FSP Visualization

Click the middleware “Motor Sensorless Vector Control” of FSP Configuration to display the connection diagram of the blocks that configure “Motor Sensorless Vector Control” in the FSP Visualization window. The FSP Visualization window is a configuration GUI for motor control software. You can change the setting values on GUI.

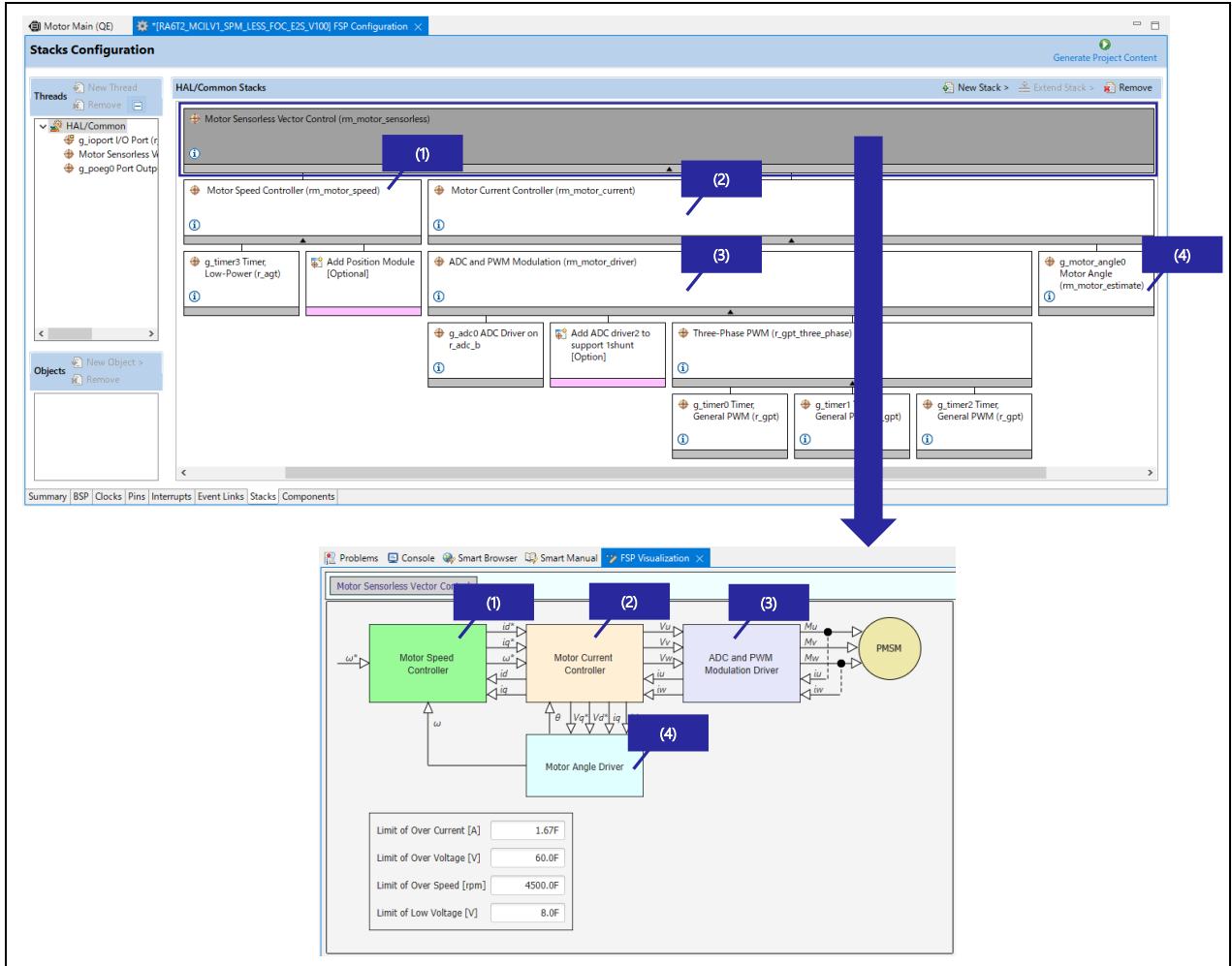

Figure 4-5 FSP Visualization view

In case that FSP Visualization is not displayed even if you click the middleware name of FSP Configuration, you can display it from the menu of e² studio as shown in the figure below.

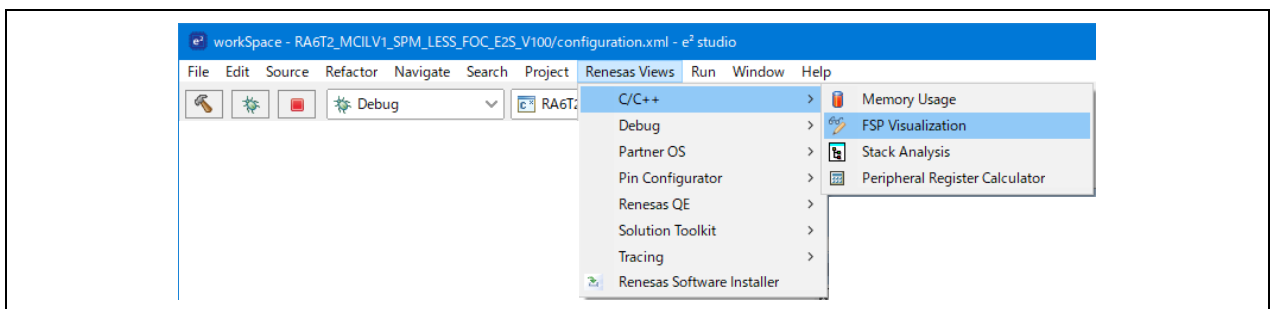

Figure 4-6 Display FSP Visualization from the menu

Click “Motor Speed Controller” of FSP Visualization to display the detailed in-block connection diagram with the setting values as shown in the figure below. With the in-block connection diagram displayed, click “Motor Sensorless Vector Control” at the top of the window to return to the block connection diagram. The same operation is performed for other blocks.

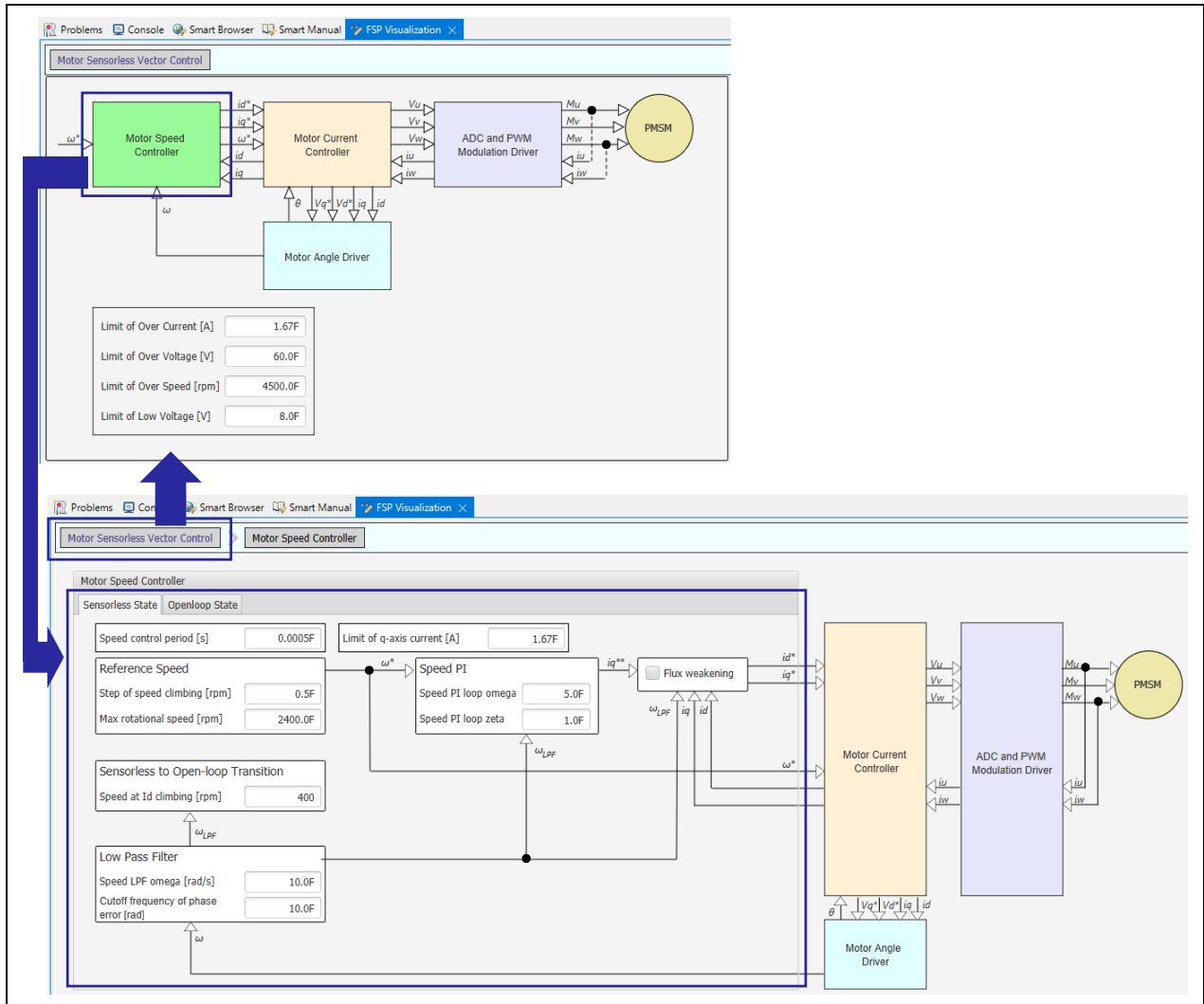

Figure 4-7 Display of the in-block connection diagram (RA family)

The settings in the FSP Visualization window correspond to the values displayed in the FSP Configuration properties. If you change one value, it will be reflected in the other value.

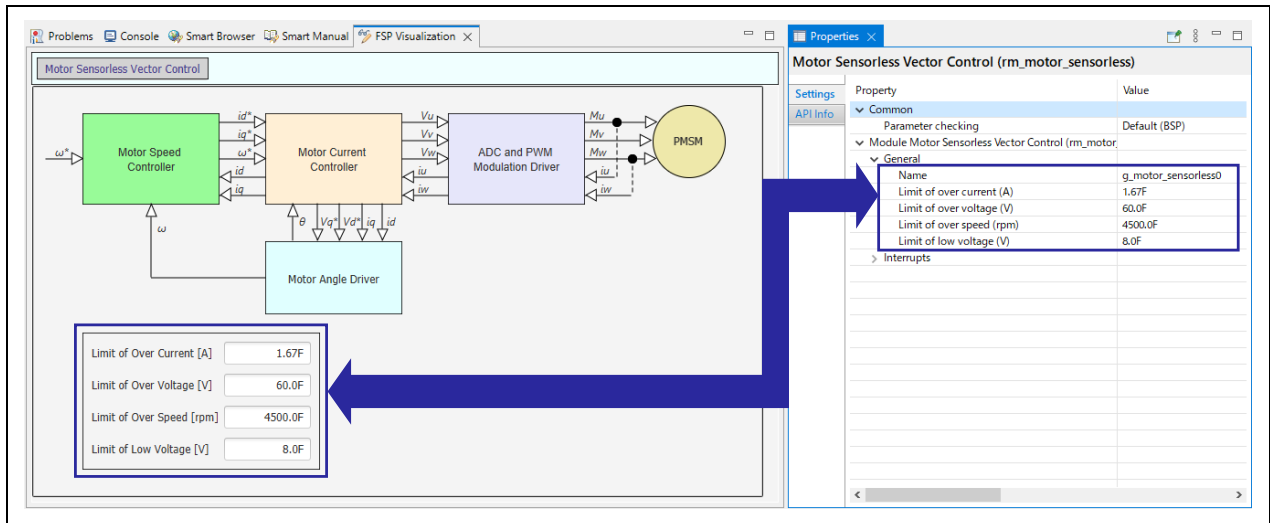

Figure 4-8 Linkage between FSP Visualization and FSP Configuration

(3) Code Generation for Middleware

In case the settings are changed in the FSP Visualization window, or in the FSP Configuration properties, click “Generate Project Content” in the upper right corner of the FSP Configuration window to reflect them in your code.

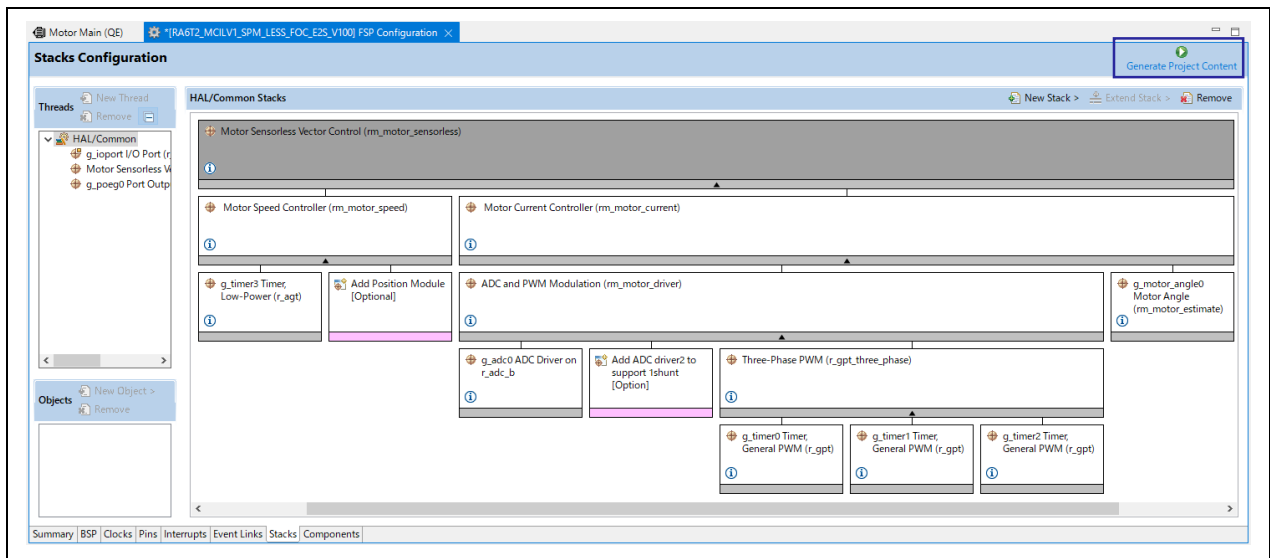

Figure 4-9 Code generation for modified middleware settings

4.1.3.2 Software Configuration for RX Family

(1) Viewing FSP Configuration

Click “Start Configuration” of “Configure Motor Software” as shown below to display the Motor Middleware Configuration (QE) window.

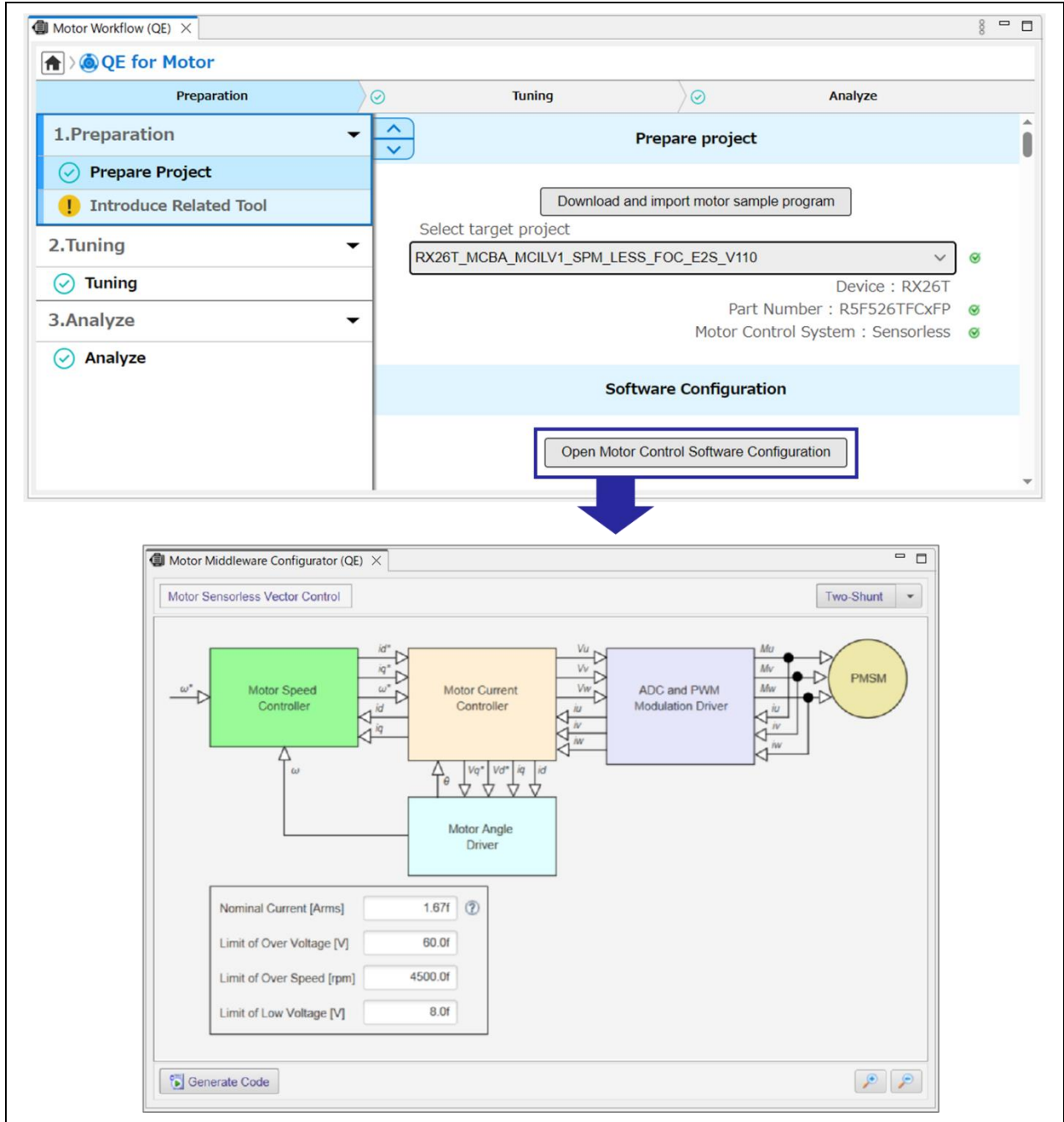

Figure 4-10 Motor Middleware Configuration (QE) View

The FSP Visualization window is a configuration GUI for motor control software. You can change the setting values on GUI.

Click “Motor Speed Controller” in the Motor Middleware Configuration (QE) view to display the detailed in-block connection diagram with the setting values as shown in the figure below. With the in-block connection diagram displayed, click “Motor Sensorless Vector Control” at the top of the window to return to the block connection diagram. The same operation is performed for other blocks.

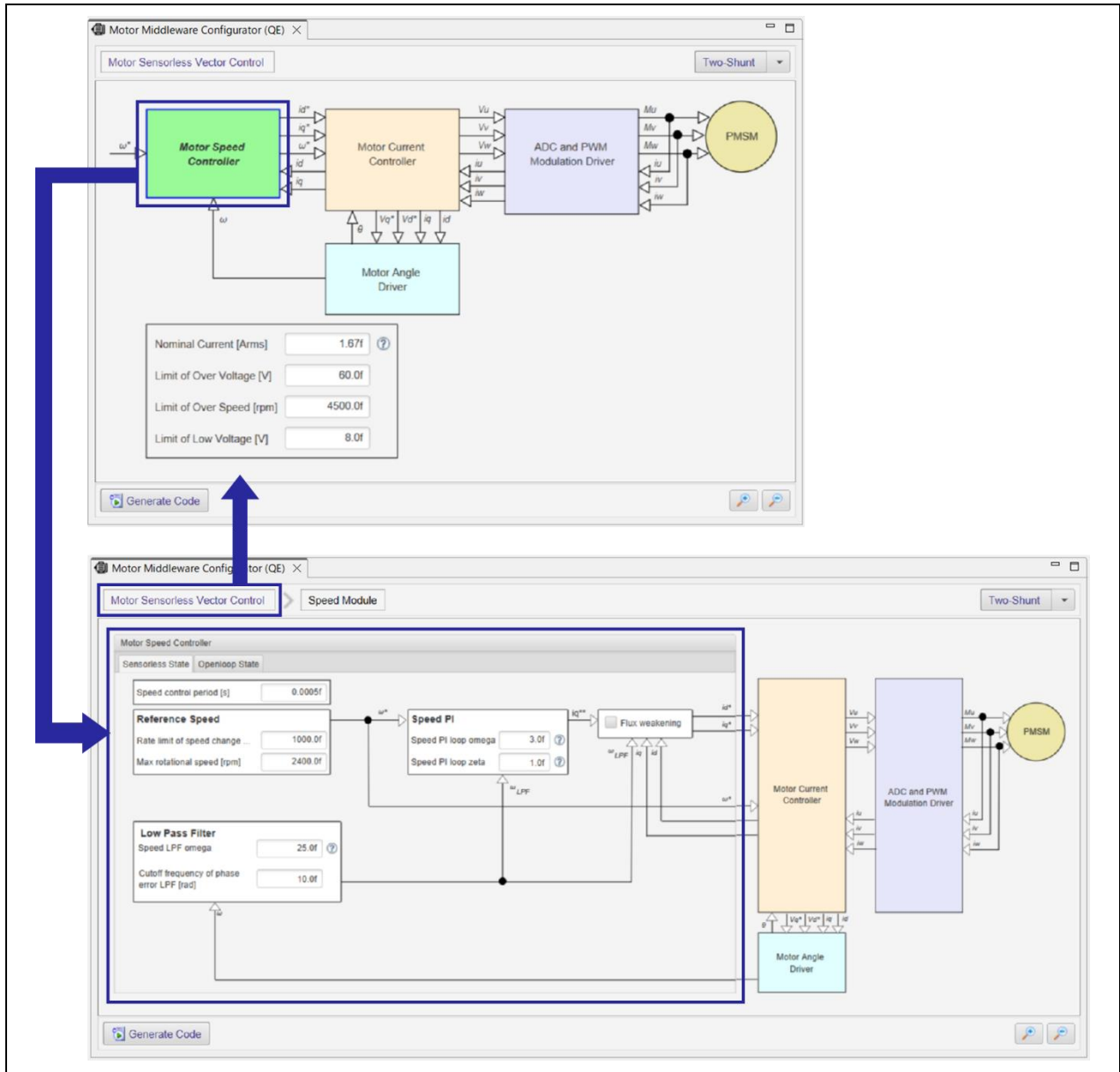

Figure 4-11 Display of the in-block connection diagram (RX family)

The settings in the Motor Middleware Configuration (QE) window correspond to the values of the motor specific parameters and the motor control parameters in the motor control software.

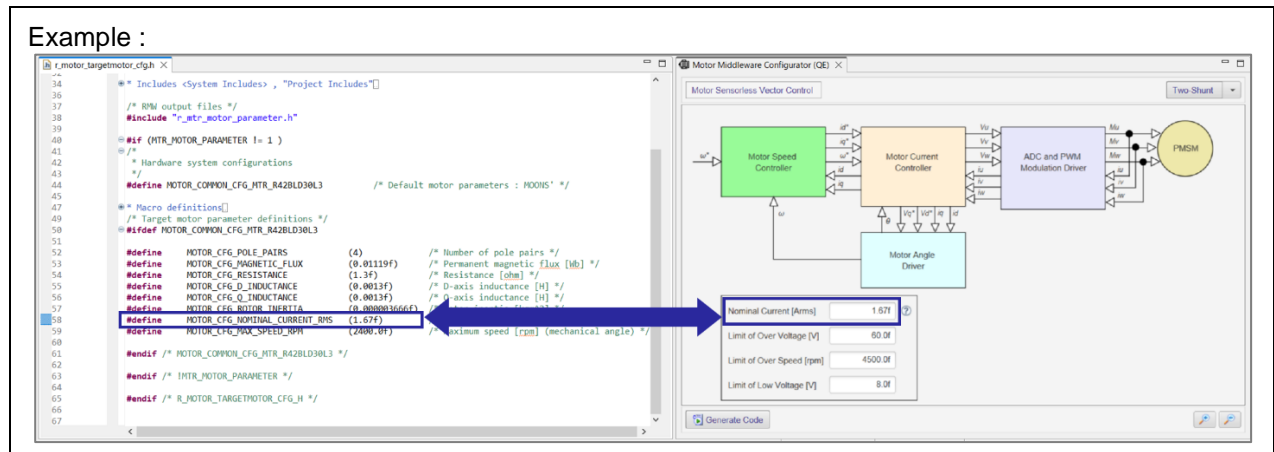

Figure 4-12 Correspondence between GUI and parameter values

(2) Code Generation for Middleware

In case the settings are changed in the Motor Middleware Configuration (QE) window, click “Generate Code” to modify the source code.

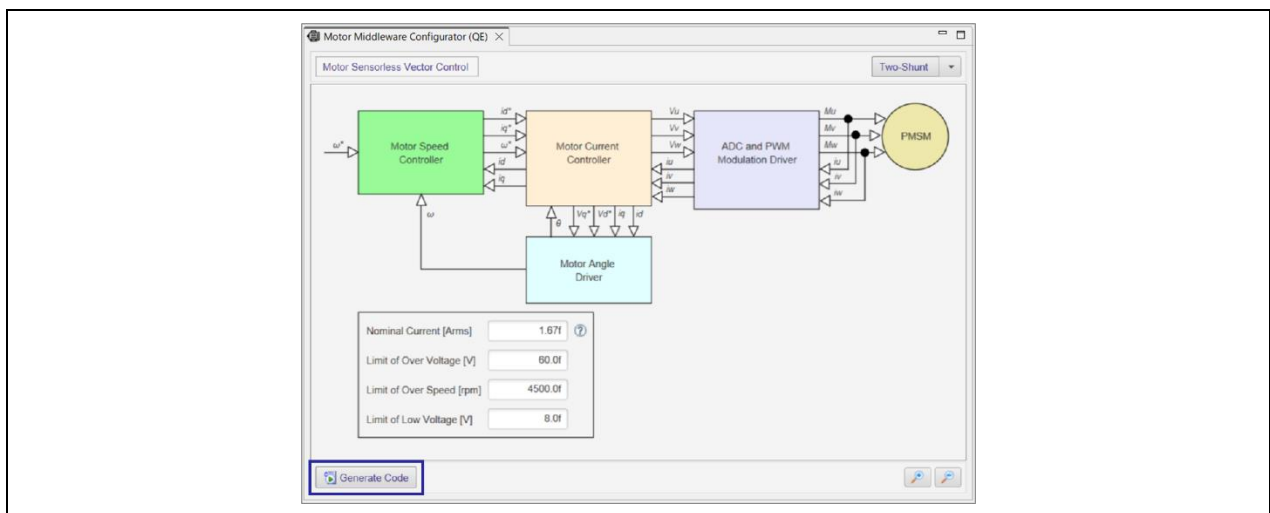
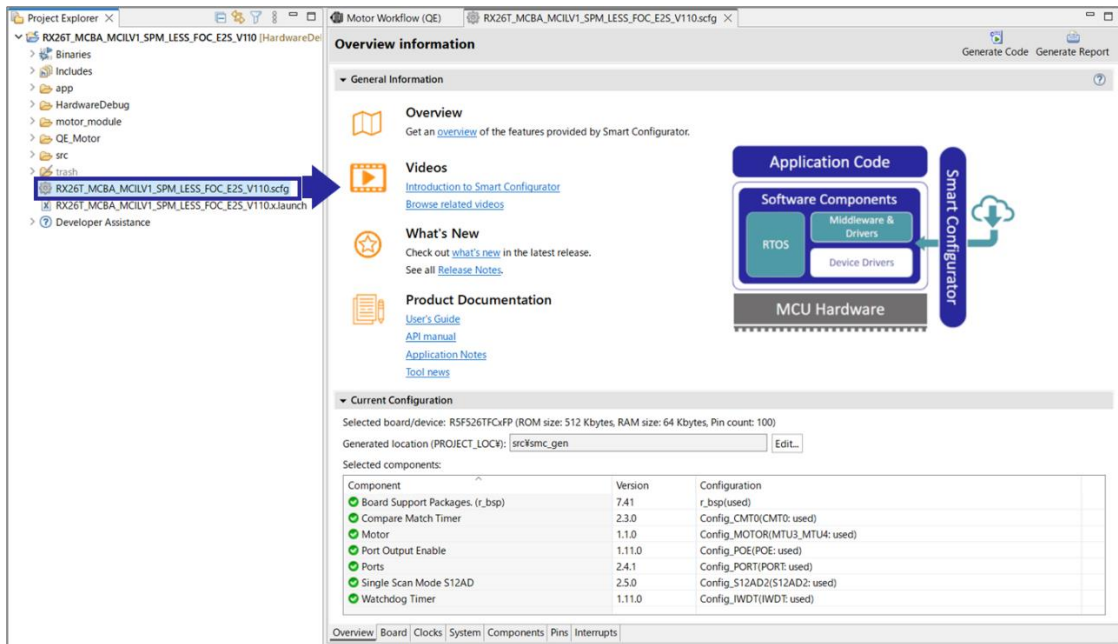

Figure 4-13 Code generation for modified middleware settings (RX family)

(3) Viewing Motor Driver Configuration

A sample project used in this guide (Sensorless Vector Control for Permanent Magnet Synchronous Motor For RX26T RAM64KB Version : RX26T_MCBA_MCILV1_SPM_LESS_FOC_E2S_Vxxx) is configured by the Motor Component of the Smart Configurator for peripheral drivers. If you need to change driver configurations such as a timer operation period or output pins, please change the settings on the Smart Configurator. Here is an example of how to change timer channels and output pins.

Clicking RX26T_MCBA_MCILV1_SPM_LESS_FOC_E2S_Vxxx.scfg on Project Explorer opens Smart Configurator view.



Selecting the Component tab and clicking Config_MOTOR open the motor driver configuration.

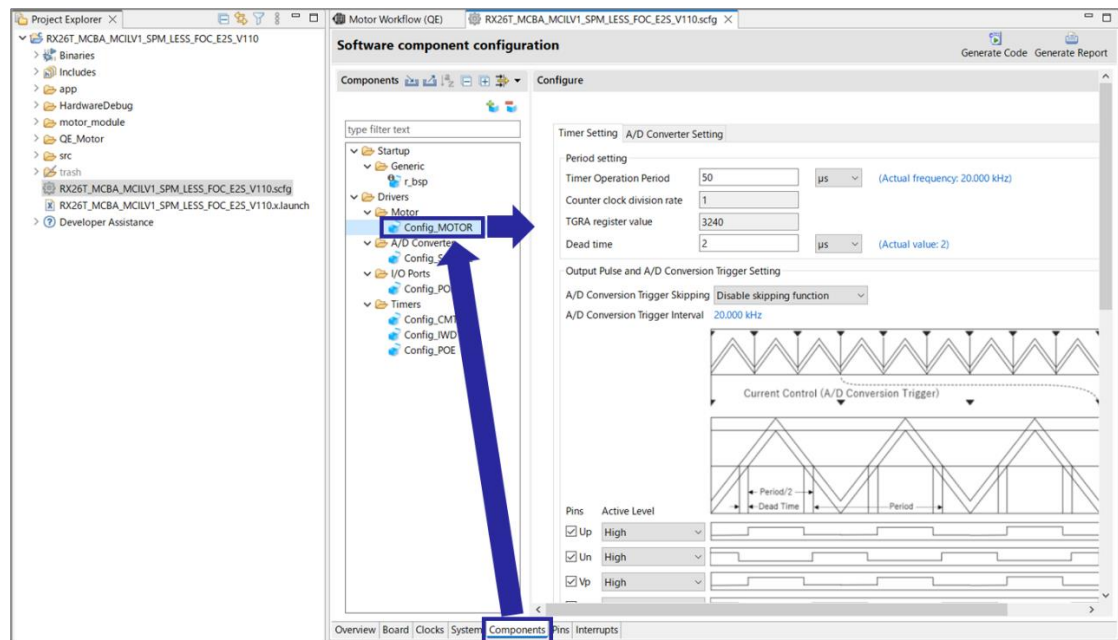
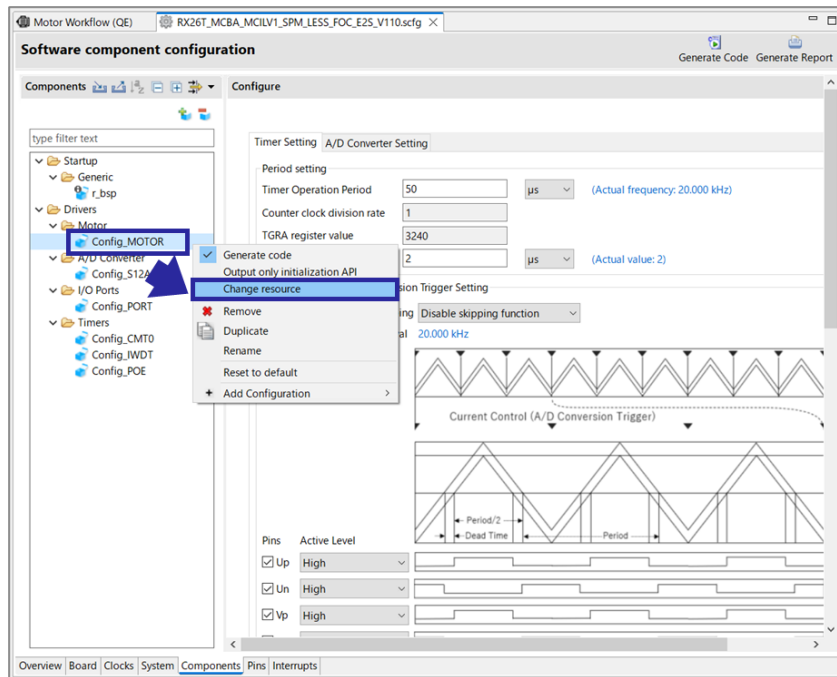

Figure 4-14 Opening Motor Driver Configuration

The timer channels can be changed as follows.

Click Config_MOTOR and select Change resource.



On the Resource Selection dialog, select timer channels.

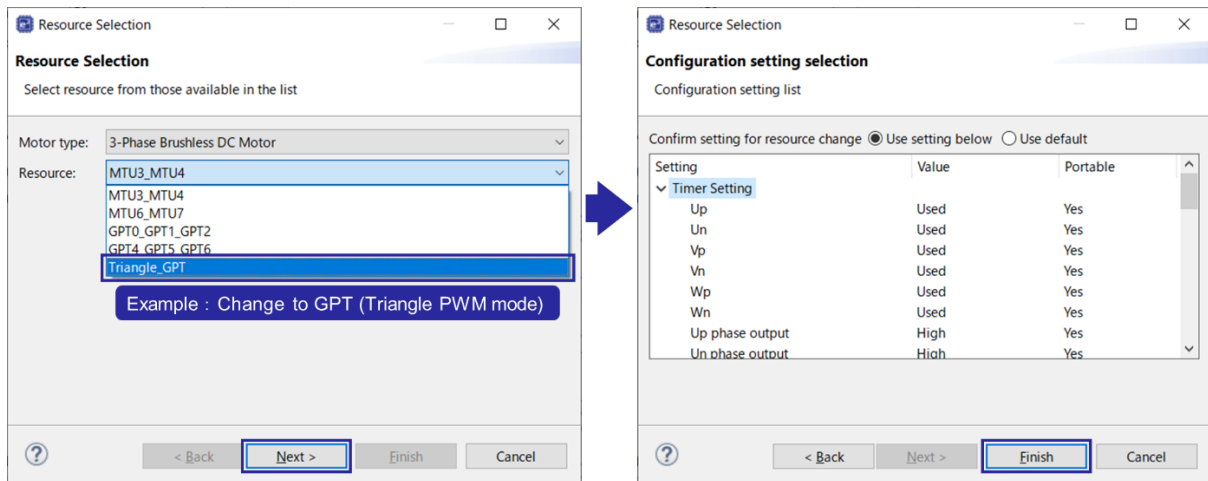
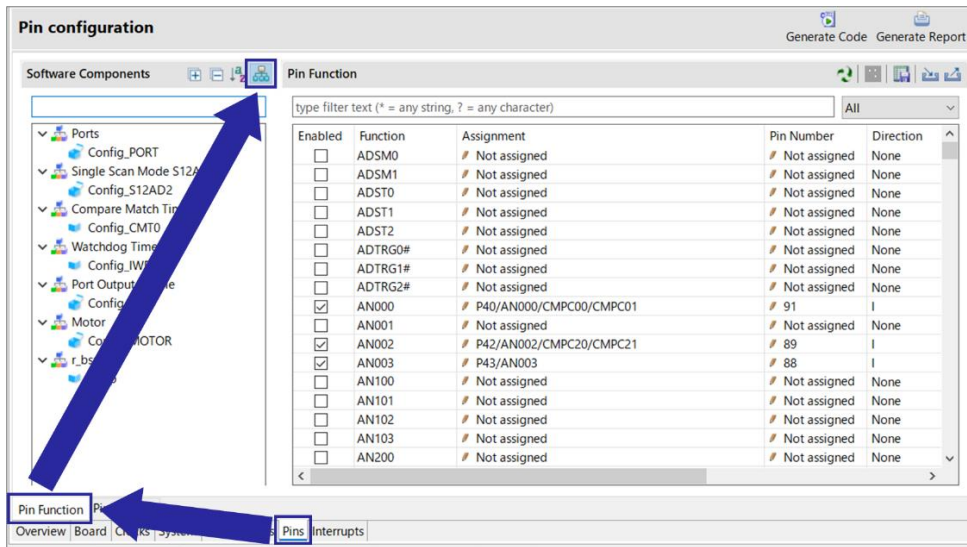

Figure 4-15 Changing timer channels

An assignment of a pin function can be changed as follows.

Select the Pins tab and the Pin Function tab to show pin functions by Software Components.



Select a pin in the Assignment column.

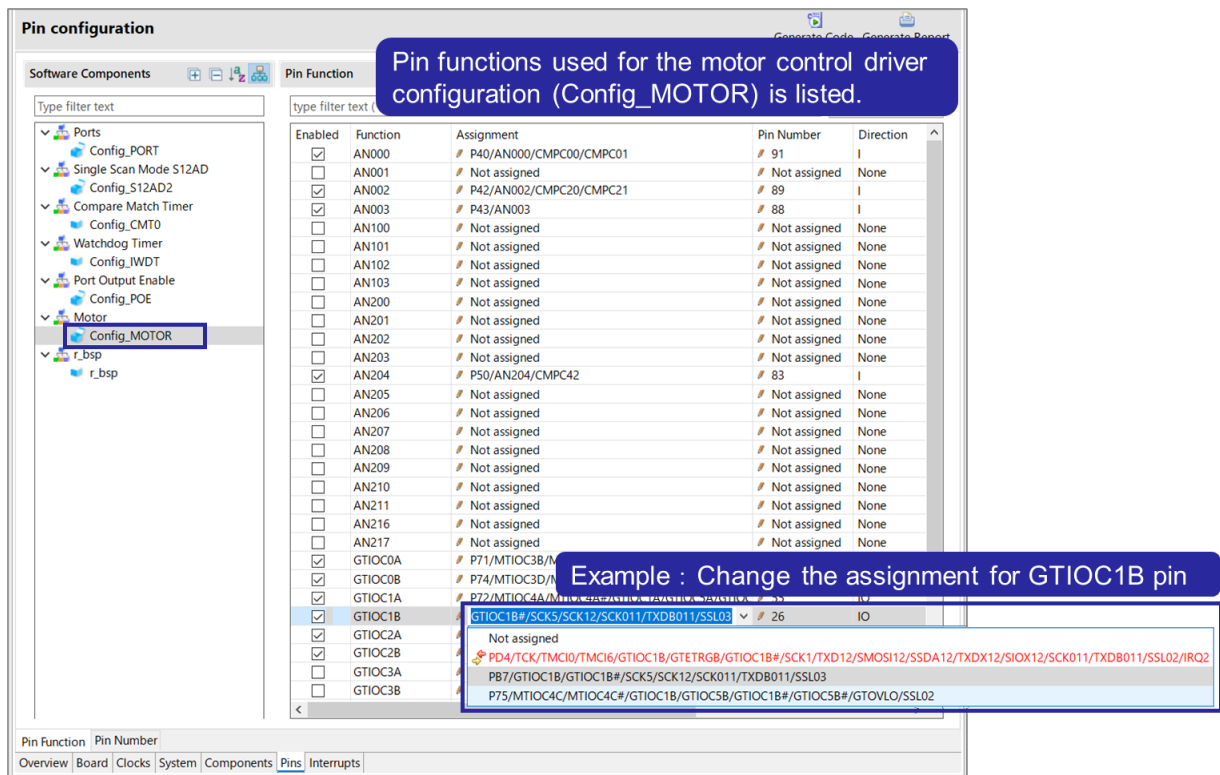

Figure 4-16 Changing a pin assignment

(4) Code Generation for Drivers

In case the settings are changed in the Smart Configurator, click “Generate Code”.

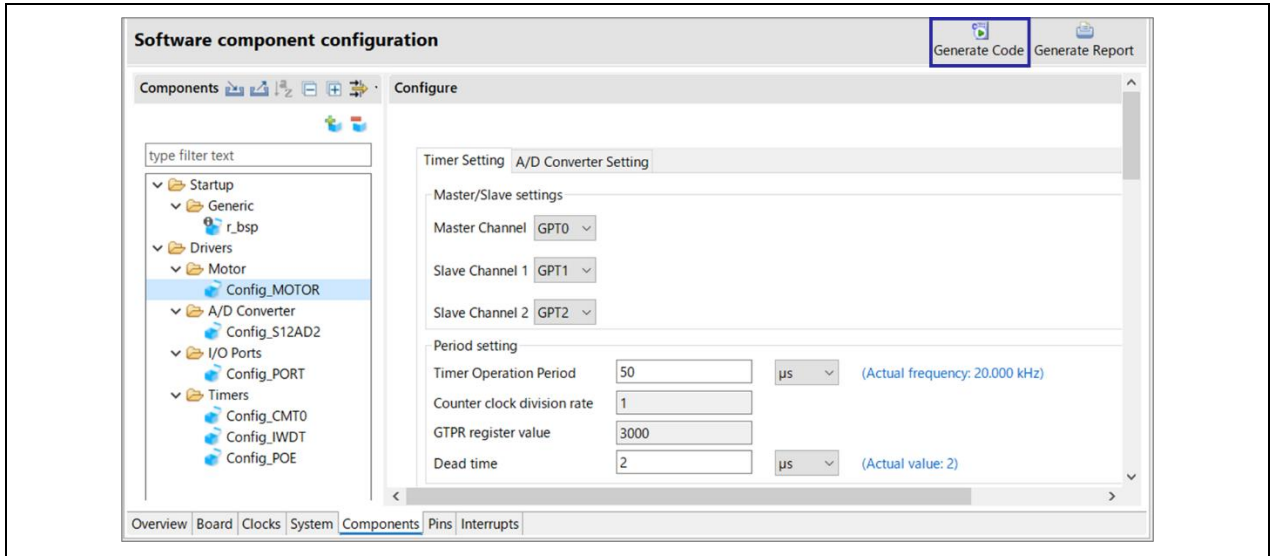

Figure 4-17 Code generation for modified driver settings (RX family)

4.1.4 Tool Settings

4.1.4.1 Install Renesas Motor Workbench

The Renesas Motor Workbench can be installed from “Download and install Renesas Motor Workbench” button in “Introduce Related Tool”. The Renesas Motor Workbench installer can be downloaded and executed by this button.

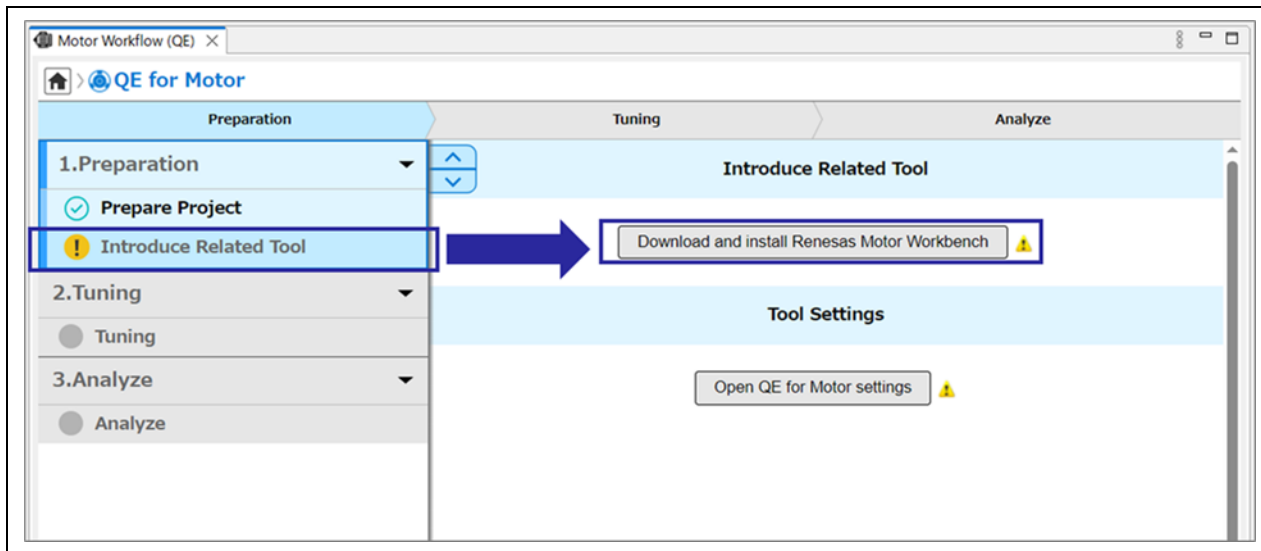

Figure 4-18 Install Renesas Motor Workbench

4.1.4.2 Configure Renesas Motor Workbench path

Click “Open QE for Motor Settings” to set the path to the Renesas Motor Workbench which is started by QE for Motor. Select “Search automatically for Renesas Motor Workbench installation” to use the Renesas Motor Workbench installed into the PC.

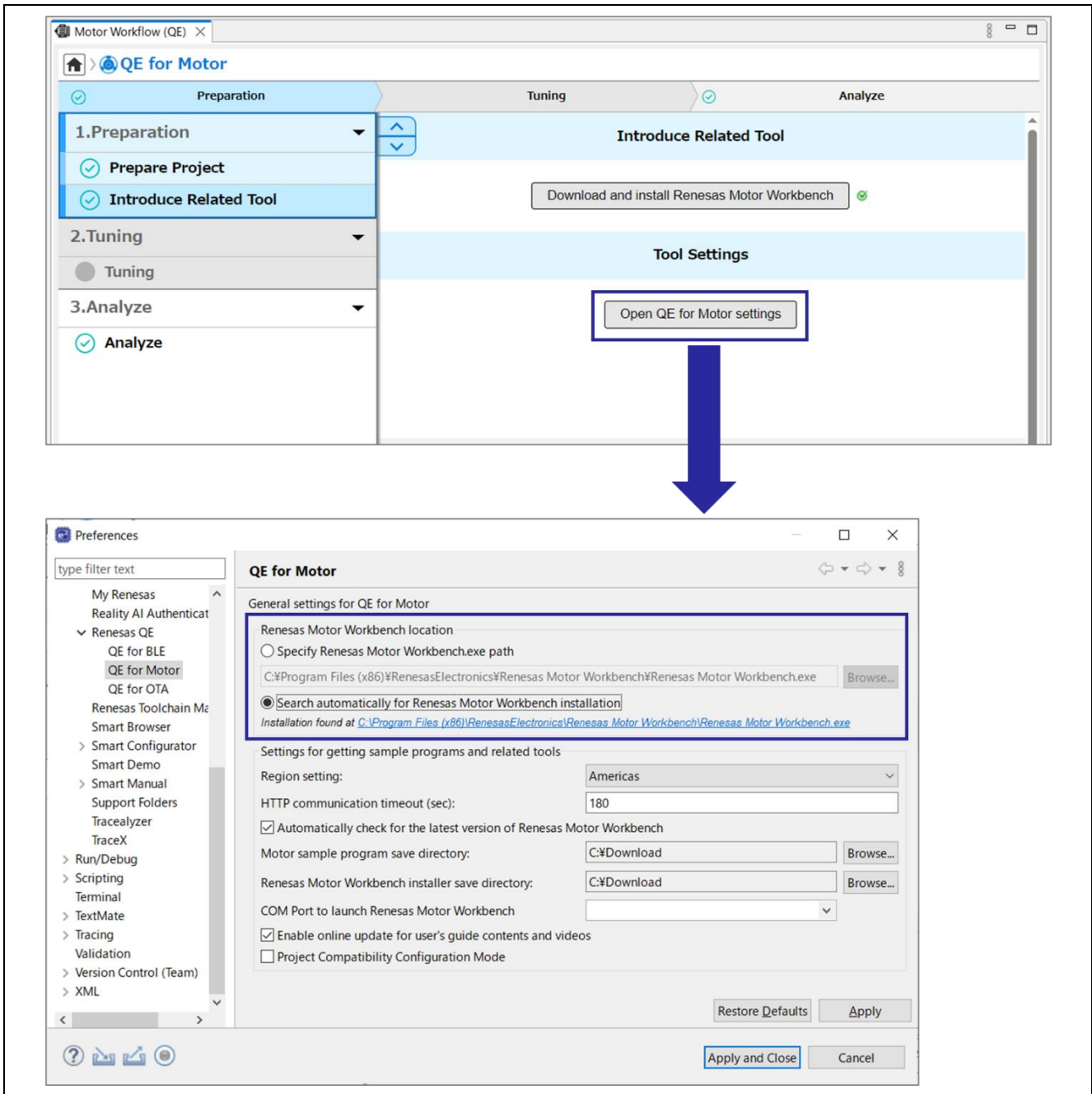

Figure 4-19 Setting the path to Renesas Motor Workbench

4.2 Tuning

4.2.1 Prepare Tuning Program

The tuning program which exists in Renesas Motor Workbench install folder is copied into the project folder, and is used. The copied files will be stored in QE_Motor¥Tuner¥<Device Name>_Sensorless in the project folder.

See Chapter 5 for the files that QE for Motor copies.

Follow the steps below to prepare the tuning program.

- Open “Motor Workflow(QE)” view
- Click “Select Tuning Program”
- Click “Finish” when Tuning Program Selection window appears.
The name of Motor Control System is automatically named according to the target project.
- Click “Generate Tuning Program” to copy the tuning program.
The tuning program is automatically copied from the Renesas Motor Workbench install folder.

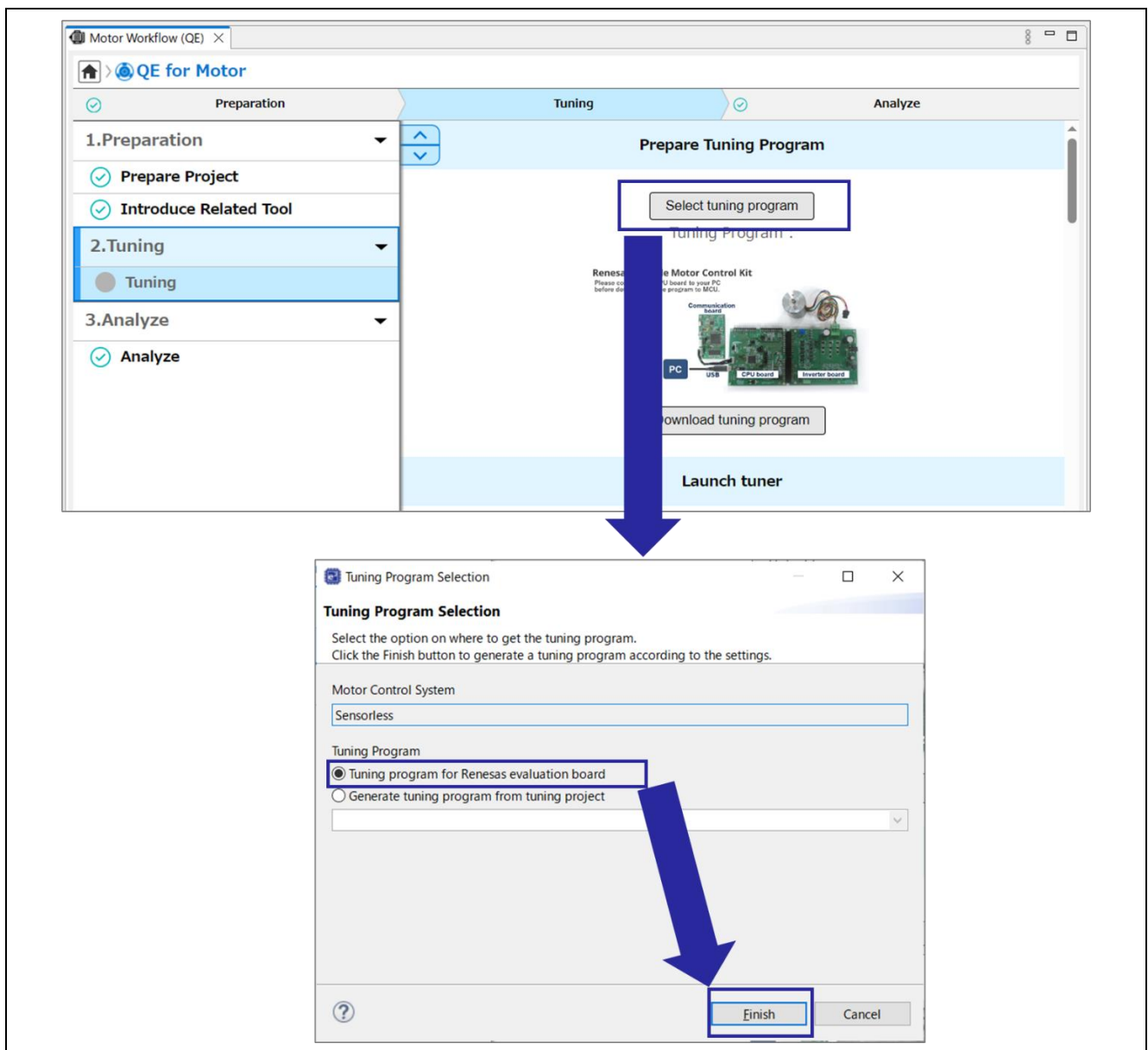

Figure 4-20 Preparation of tuning program

4.2.2 Download Tuning Program

Download the tuning program to MCU on the CPU Board.

The PC and evaluation board must be connected to download the tuning program. Refer to the picture displayed on the workflow view and chapter 2.3.1 for the connection method when downloading the program.

Follow the steps below to download the tuning program.

- Connect your PC to the evaluation board.
- Click “Download” to download the tuning program.

When downloading finishes, the debugger is disconnected.

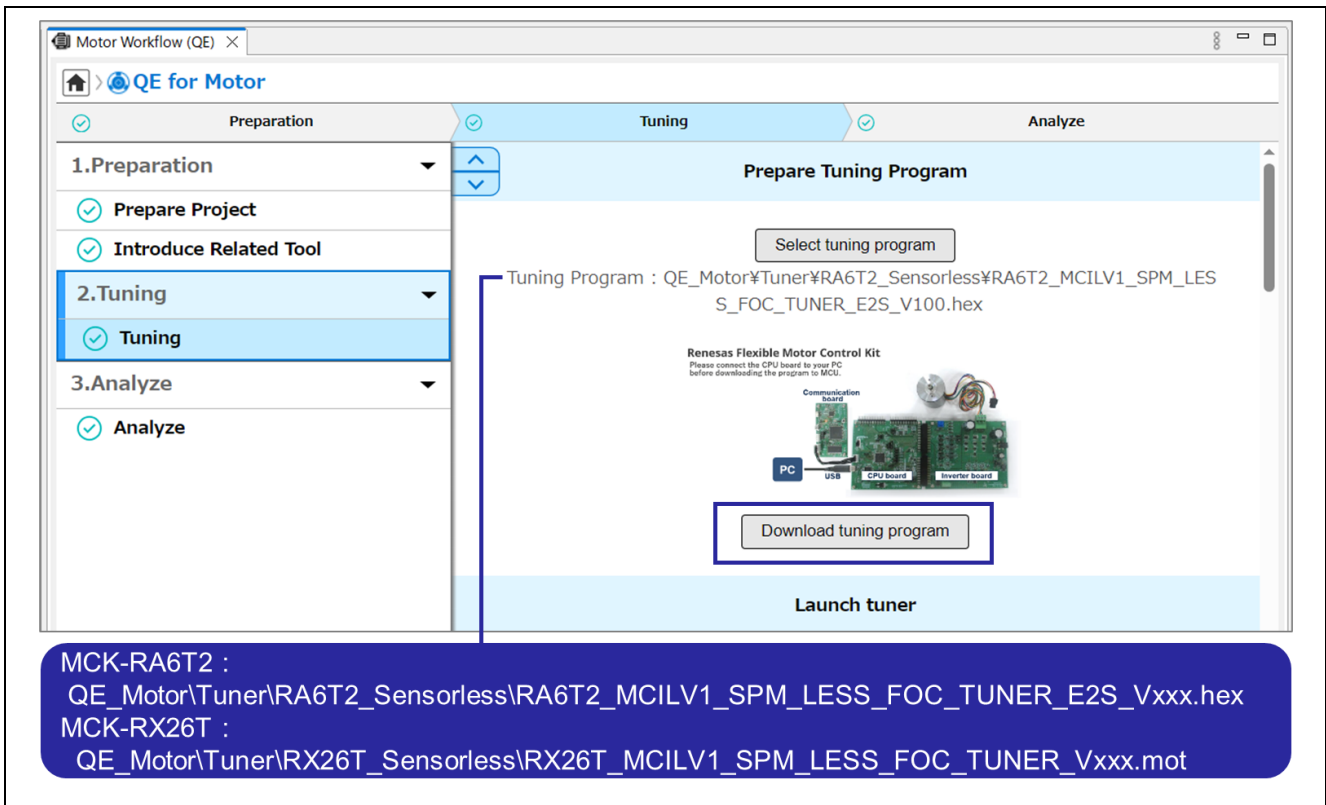

Figure 4-21 Download of tuning program

4.2.3 Start Tuner

To start tuner, it is necessary to connect the PC and the evaluation board via the communication board. Refer to the picture displayed on the workflow view and chapter 2.3.2 for the connection method when checking the motor operation by Tuner.

Click “Launch Tuner” as shown below to launch the Renesas Motor Workbench Tuner. The settings required for tuning with Renesas Motor Workbench are automatically loaded from the Tuner configuration file. If Tuner does not start and an error is displayed, see Section 4.2.3.1.

For the first time use of Tuner in the target project, a Tuner configuration file (.rmt) corresponding to the sample project is copied from the Renesas Motor Workbench install folder to QE_Motor\Tuner\<Device Name>_Sensorles in the project folder by “Use Default Configuration(xxx.rmt)”. From the second time onward, a Tuner configuration file copied into the project can be selected.

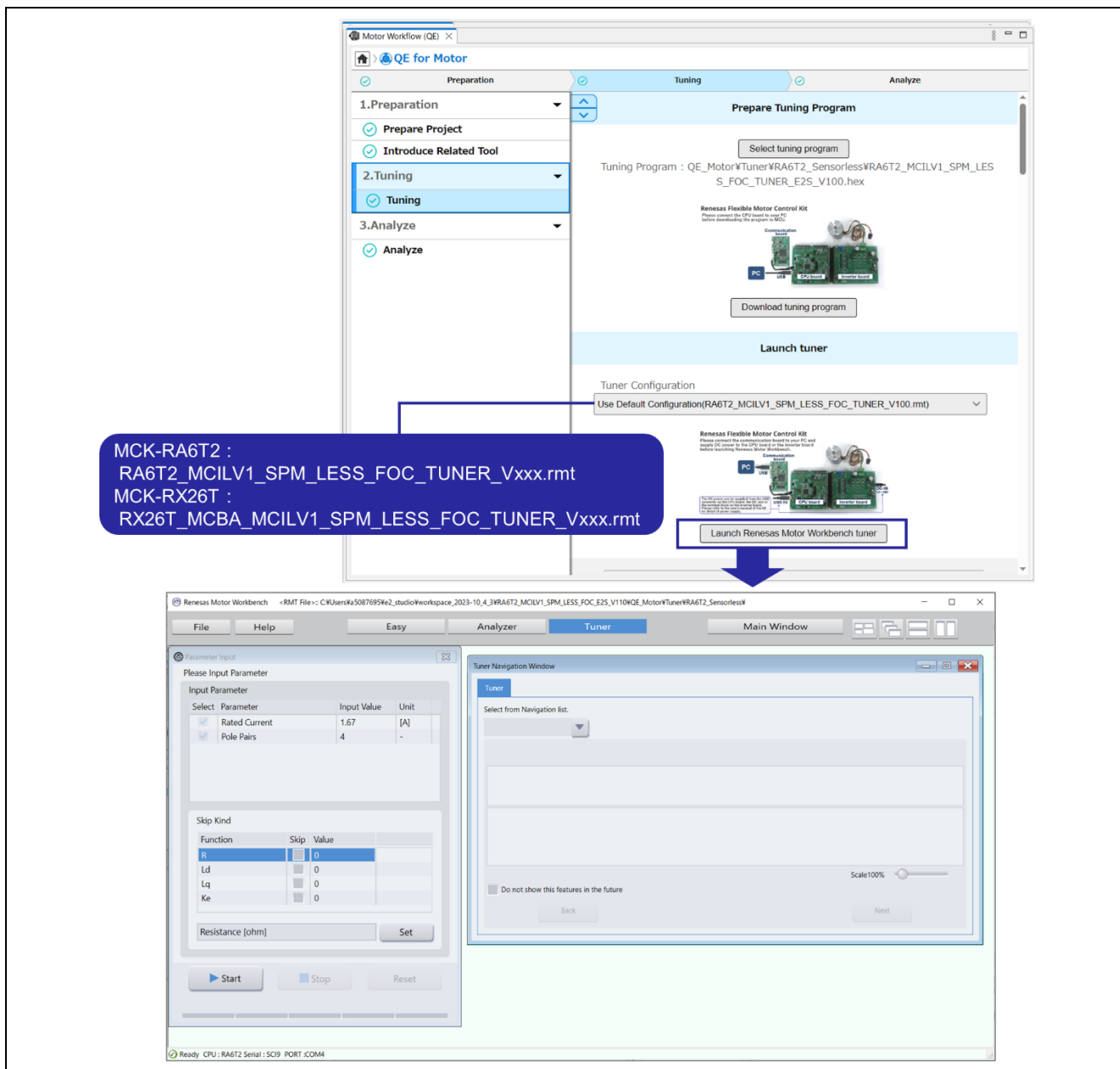

Figure 4-22 Start Tuner

For details on the Tuner function of Renesas Motor Workbench, refer to “R21UZ0004 Motor Control Development Support Tool Renesas Motor Workbench 3.1.2 User’s Manual”.

4.2.3.1 Installation of VCP driver

If the error shown below is displayed, the virtual COM port (VCP) driver needs to be installed. If you do not see any error, you do not need to do anything in this chapter.

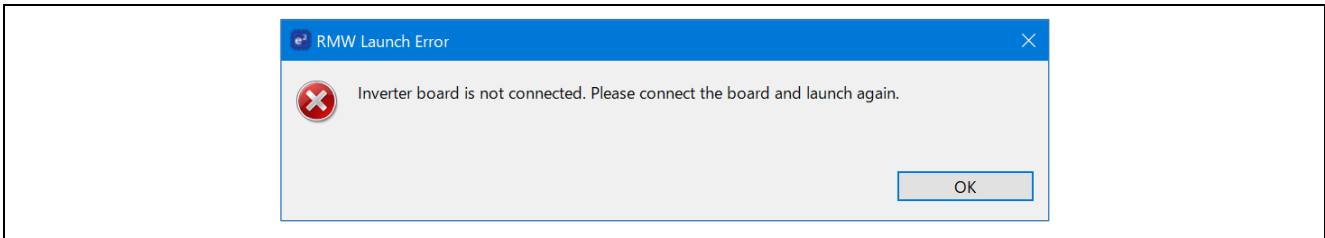

Figure 4-23 RMW Launch Error

When installing the VCP driver, disconnect the USB cable that connects the PC and the evaluation board. Download the FTDI VCP driver from the following website. Figure 4-24 to Figure 4-25 show the installation procedure of the downloaded VCP driver.

- <https://www.ftdichip.com/Drivers/VCP.htm>

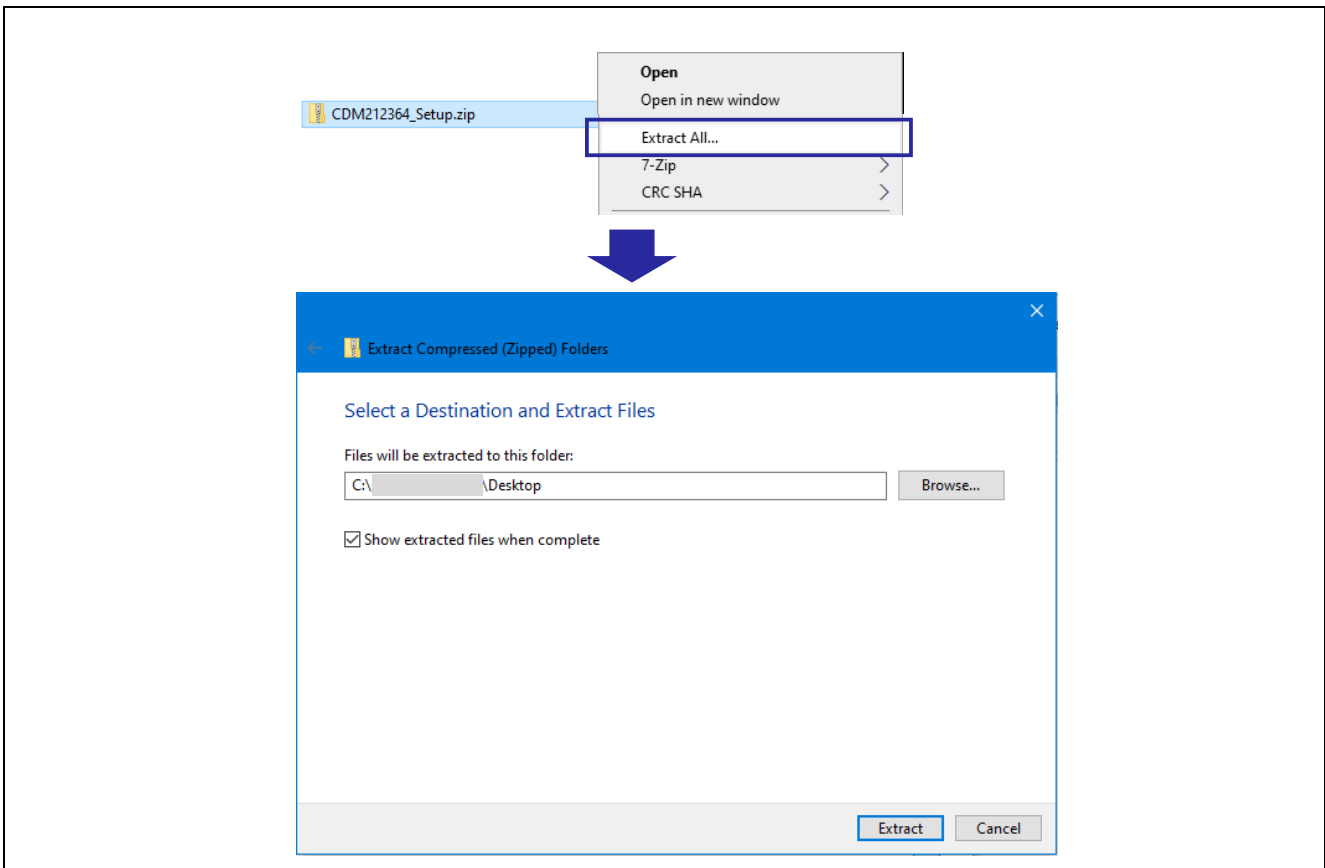

Figure 4-24 Extracting of VCP driver



Figure 4-25 Installation of VCP driver

4.2.3.2 Start Tuning

Click “Start” to start the motor. When tuning is complete, the motor will stop and the tuning result will be displayed.

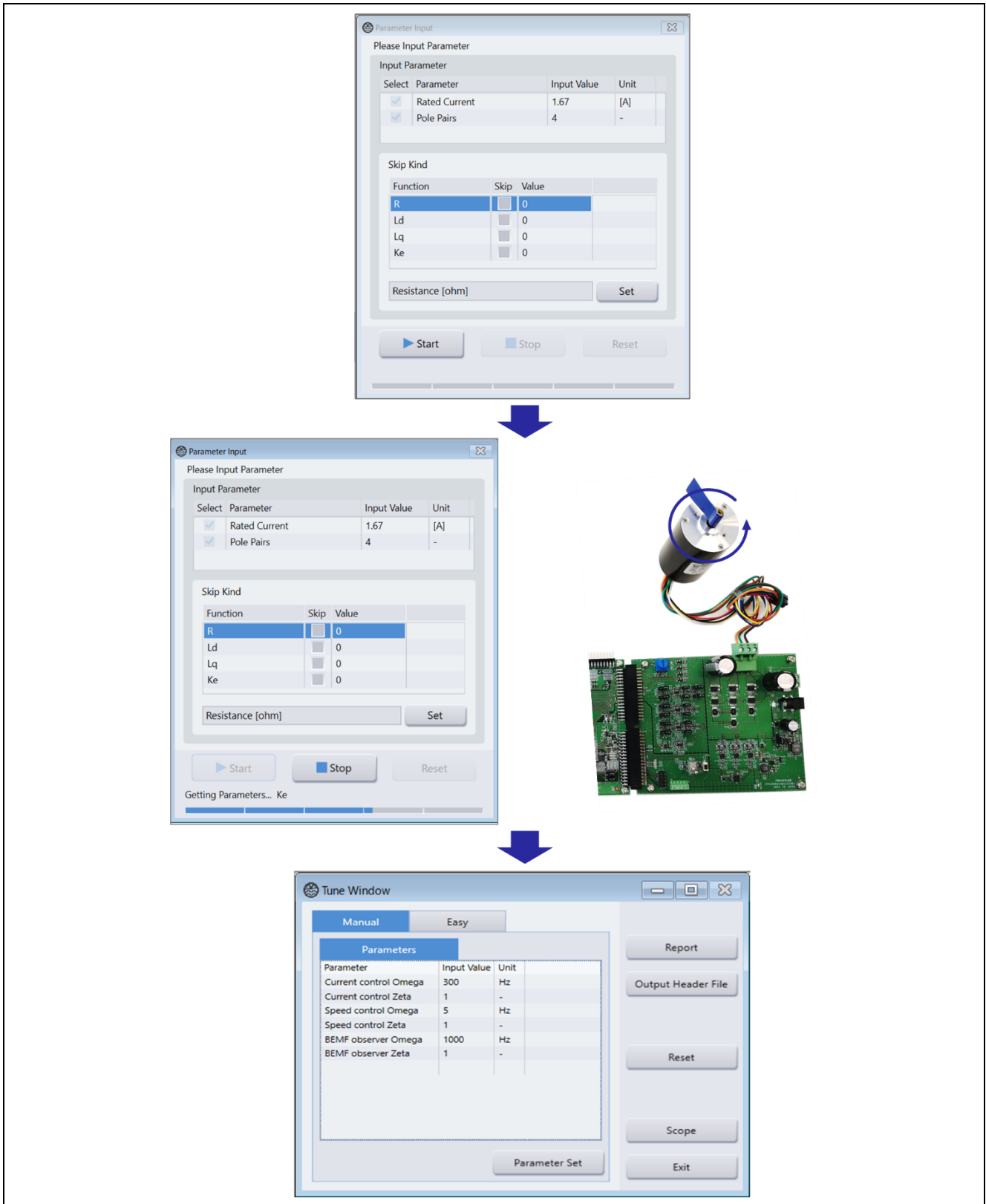

Figure 4-26 Tuning operation

4.2.3.3 Waveform Confirmation

Click “Scope” to check the waveform during motor operation. Click “RUN” to start the motor, and click “STOP” to stop the motor. To finish checking the waveform, click the “x” at the top right of the window.

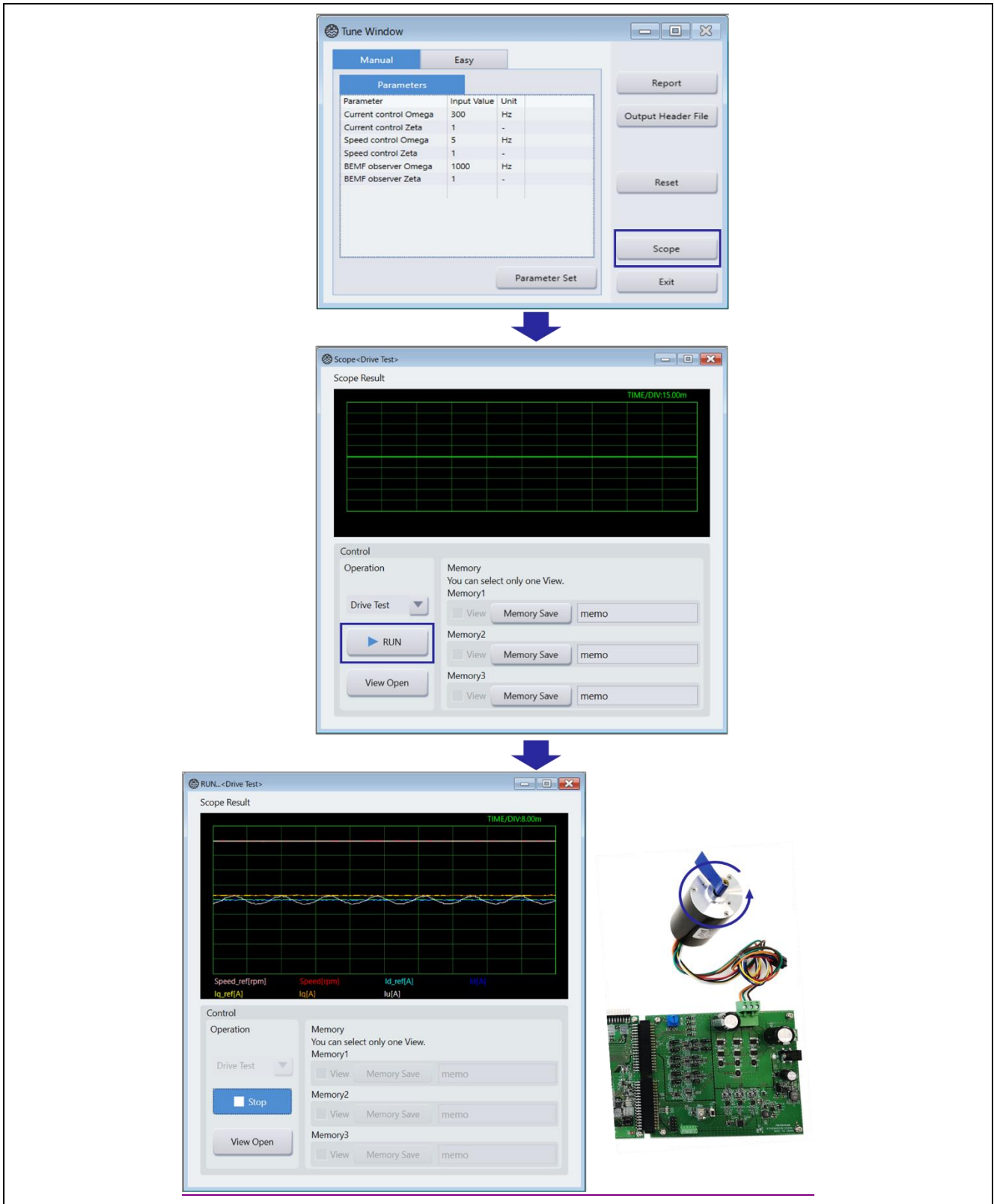

Figure 4-27 Waveform confirmation

4.2.3.4 Output Header File

Click “Output Header File” as shown below to output the tuning result C source header file. The file output in this chapter are stored in the src¥application¥main folder.

For the files output by QE for Motor, refer to Chapter 5.

When tuning is complete, click “x” in the upper right corner of the window to exit Renesas Motor Workbench. After checking the motor operation by Tuner, cut off the power supply from J1 or CN1 of the Inverter Board.

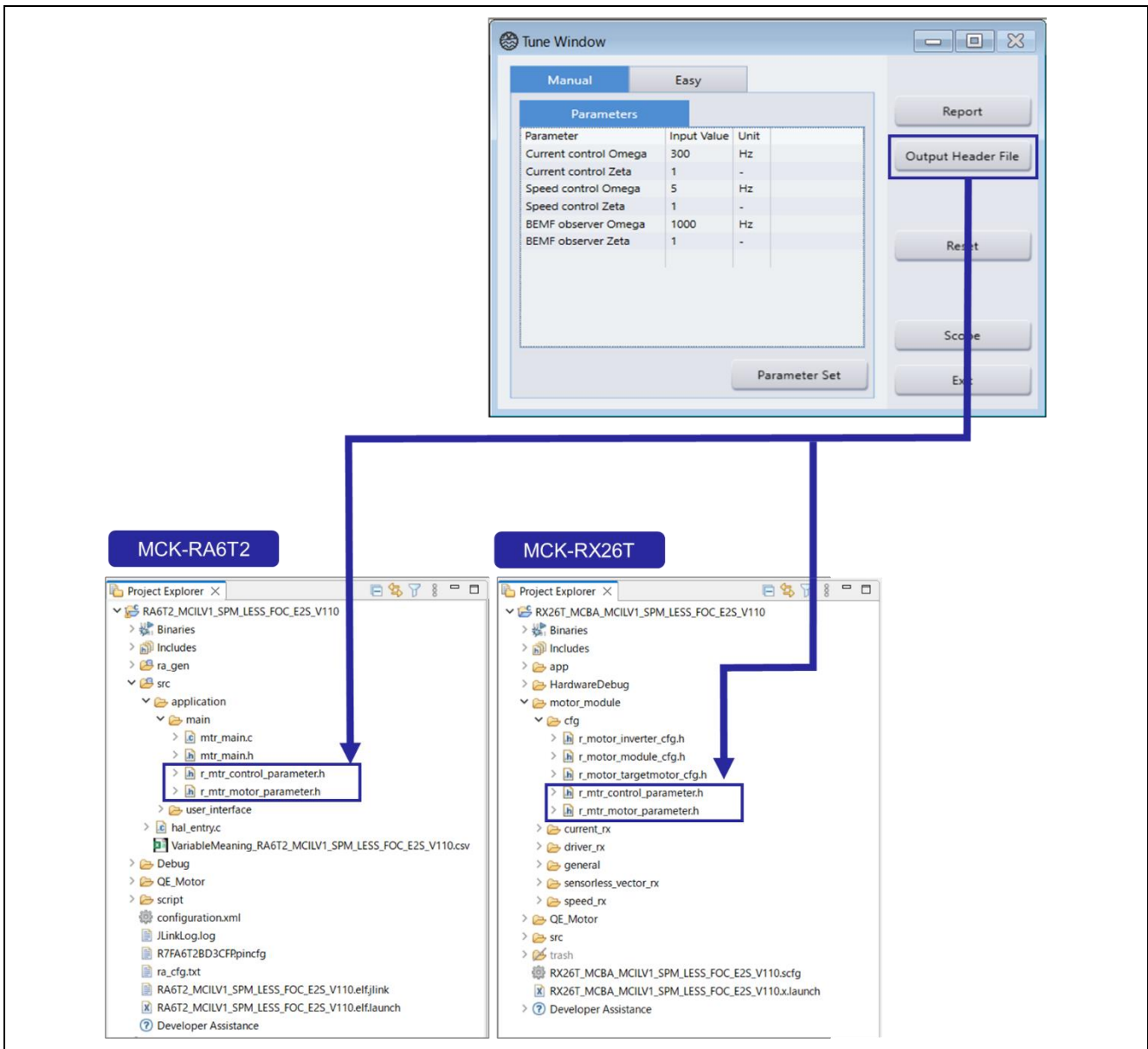

Figure 4-28 Output Header file

4.3 Analyze

4.3.1 Build Application Program

Click “Build Project” to build the project.

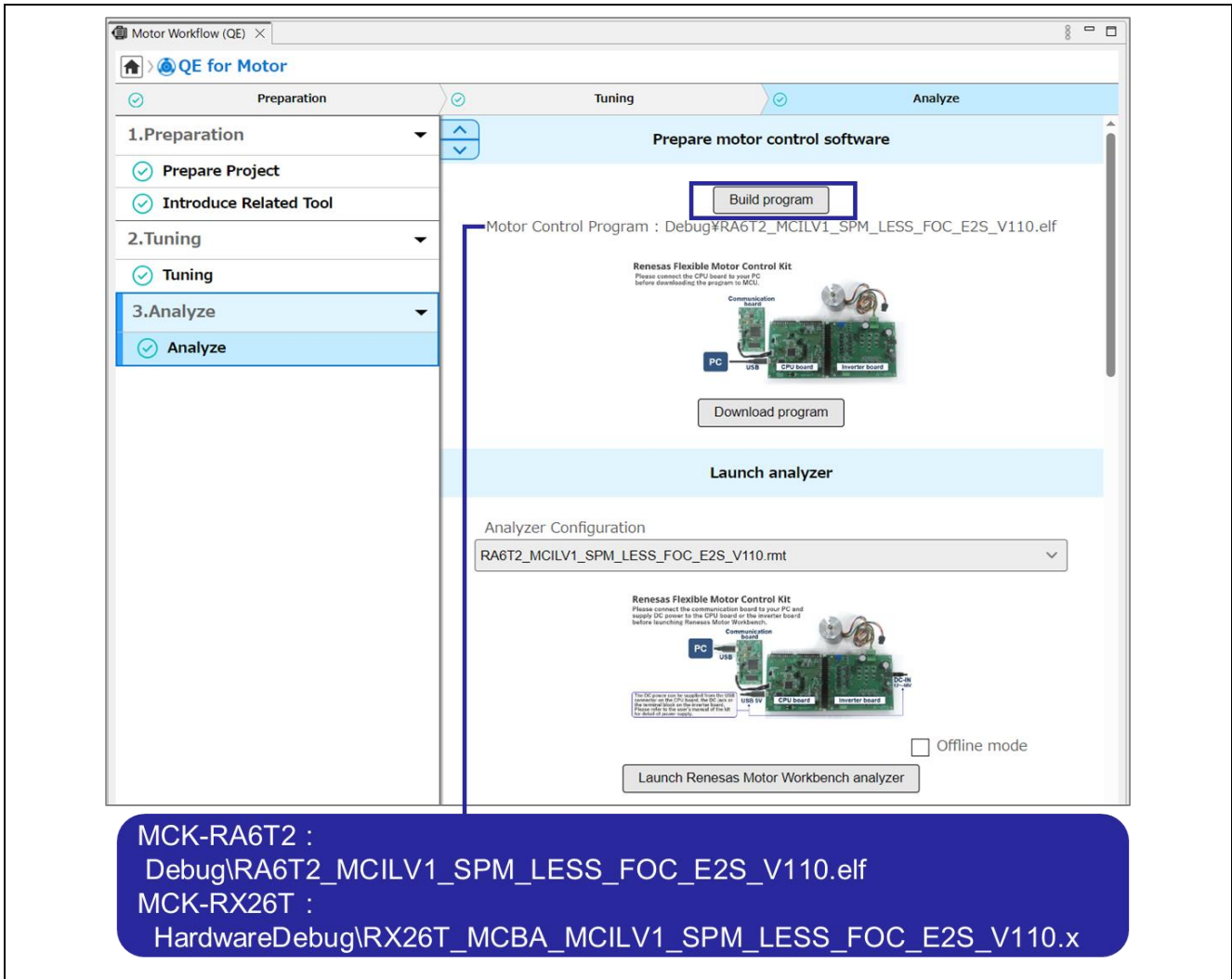

Figure 4-29 Build Project

If build errors have been occurred in RA family project, the code generation may not have been executed because of using different FSP version than the sample project.

Refer to Chapter 4.1.3, execute the code generation, and then execute the build again.

4.3.2 Download Application Program

Download the project to MCU on the CPU Board. The PC and evaluation board connection is required to download the sample project. Refer to the picture displayed on the workflow view and chapter 2.3.1 for the connection method when downloading the project.

Follow the steps below to download the project.

- Connect the PC and the evaluation board.
- Click “Download program” to download the project.

When downloading finishes, the debugger is disconnected.

MCK-RA6T2 :
Debug\RA6T2_MCILV1_SPM_LESS_FOC_E2S_V110.elf

MCK-RX26T :
HardwareDebug\RX26T_MCBA_MCILV1_SPM_LESS_FOC_E2S_V110.x

Figure 4-30 Download Application Program

4.3.3 Start Analyzer

To start Analyzer, it is necessary to connect the PC and the evaluation board via the communication board. Refer to the picture displayed on the workflow view and chapter 2.3.2 for the connection method when checking the motor operation with Analyzer.

Click “Launch Renesas Motor Workbench analyzer” as shown below to launch Analyzer of Renesas Motor Workbench. The settings required for analysis in Renesas Motor Workbench are automatically loaded from Analyze configuration file. If Analyzer does not start and an error is displayed, see Section 4.2.3.1.

The sample projects used in this guide includes analyzer configuration file.

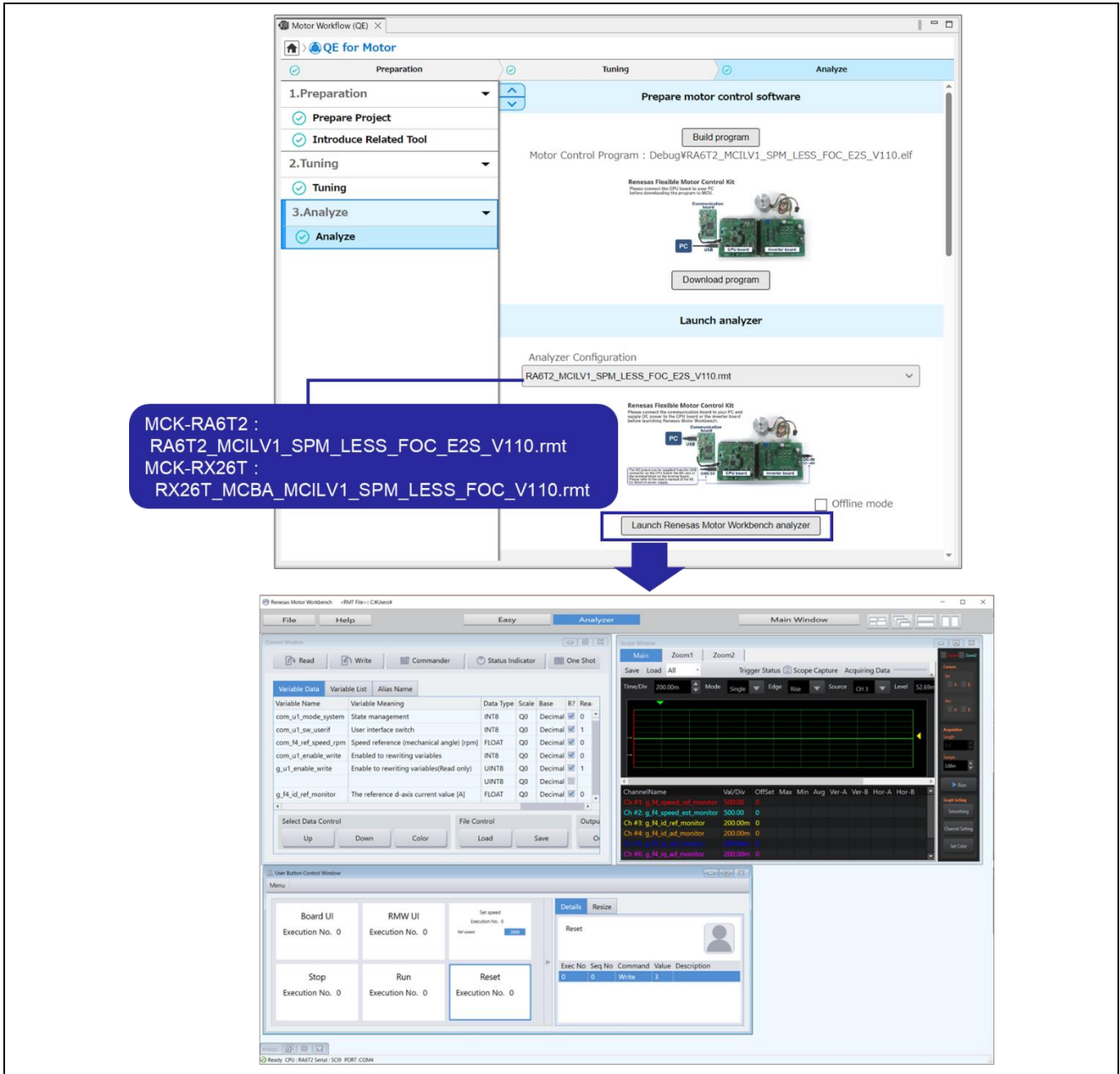

Figure 4-31 Start Analyzer

For details on the Analyzer function of Renesas Motor Workbench, refer to “R21UZ0004 Motor Control Development Support Tool Renesas Motor Workbench 3.1.2 User’s Manual”.

The sample project provides two modes of operation, Board UI and RMW UI. This document describes an operation example of the RMW UI that controls the motor operation from the Analyzer of Renesas Motor Workbench.

4.3.3.1 Start to Analyze

Follow the steps below to analyze the motor operation.

- Click “RUN” in the Scope Window to start analysis – (1)
- Click “RMW UI” in the User Button Control Window – (2)
Select RMW UI mode to control the motor from Renesas Motor Workbench.
- Click “RUN” in the User Button Control Window to start the motor – (3)
- Change the Ref speed value in the User Button Control Window and click “Set Speed” to change the motor rotation speed – (4)
- Click “STOP” in the User Button Control Window to stop the motor – (5)

The User Button Control Window may be hidden at the bottom of the screen. If you cannot see it after launching Analyzer, try expanding the window.

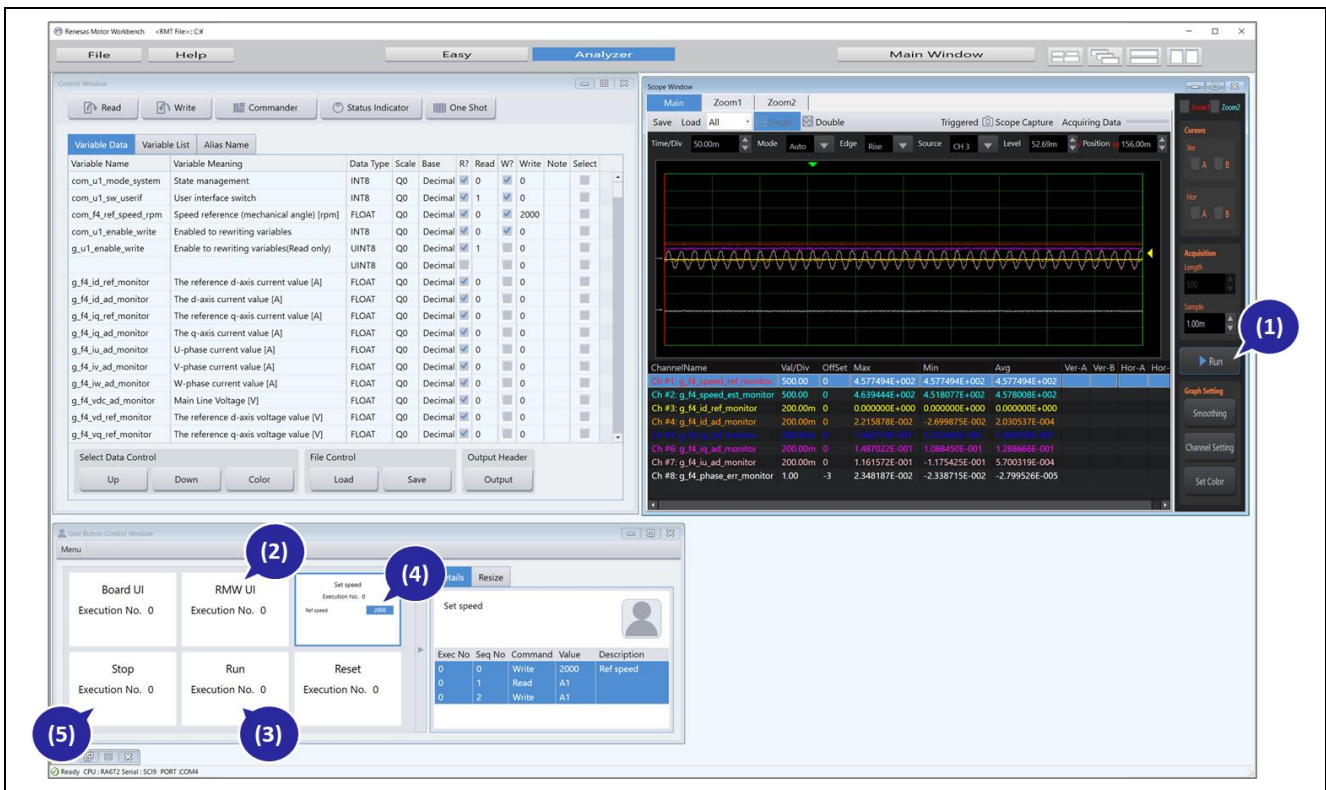

Figure 4-32 Analyze the motor operation

By clicking “Easy” at the top of the window, you can easily change the motor speed etc. using the GUI.

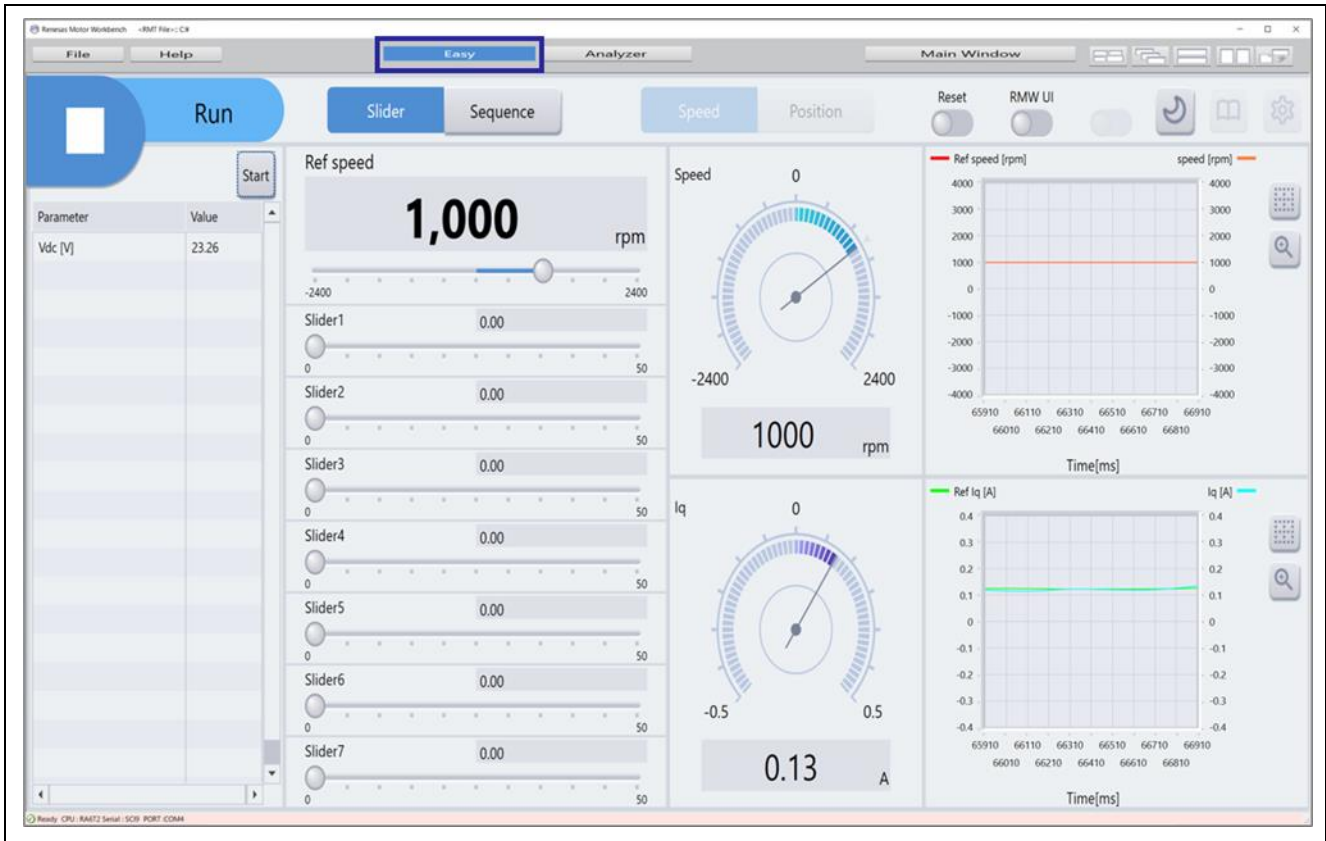

Figure 4-33 Viewing of Easy mode

5. Output Files

The files output by QE for Motor and Renesas Motor Workbench (RMW) are as follows.

Table 5-1 List of output files

Folder name	File name	Generated item
QE_Motor¥Tuner¥ [Motor control system name]	[RMW bundled file name *1].hex	Tuning program
	[RMW bundled file name *1].sbd*2	
	[RMW bundled file name *1].rmt	Tuner configuration file
QE_Motor	[Project name].qmc	RMW launch configuration file
src¥application¥main*2 motor_module¥cfg¥*3	r_mtr_control_parameter.h	Tuning result
	r_mtr_motor_parameter.h	

*1: This is the file name included with Renesas Motor Workbench. Renesas Motor Workbench includes files for various evaluation boards. The file corresponding to the motor control system selected in the tuning program preparation is used.

*2: For the sample program for RA6T2 : RA6T2_MCILV1_SPM_LESS_FOC_E2S_Vxxx

*3: For the sample program for RX26T : RX26T_MCBA_MCILV1_SPM_LESS_FOC_E2S_Vxxx

6. Help and Guide Function

You can check the details of the functions of “QE for Motor” from the help of e² studio.

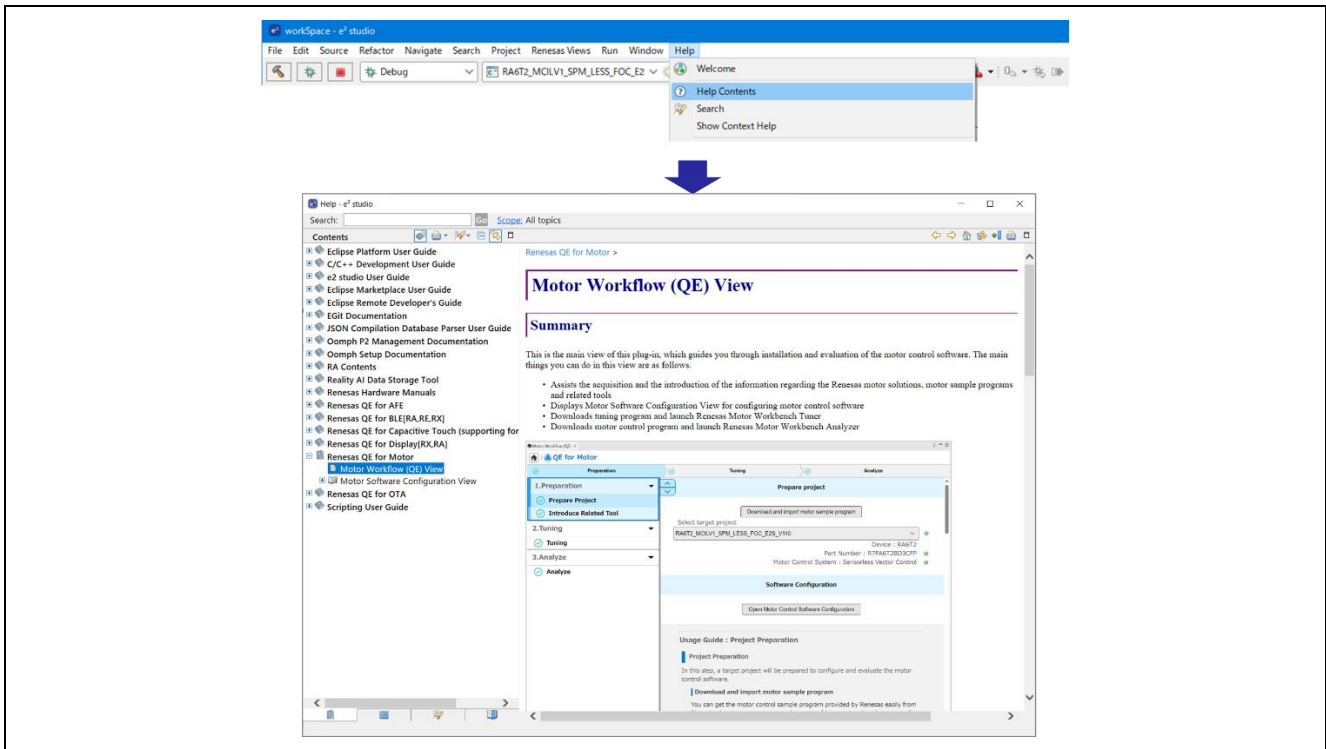

Figure 6-1 Help function

Also, usage guide information is displayed at the bottom of each workflow page.

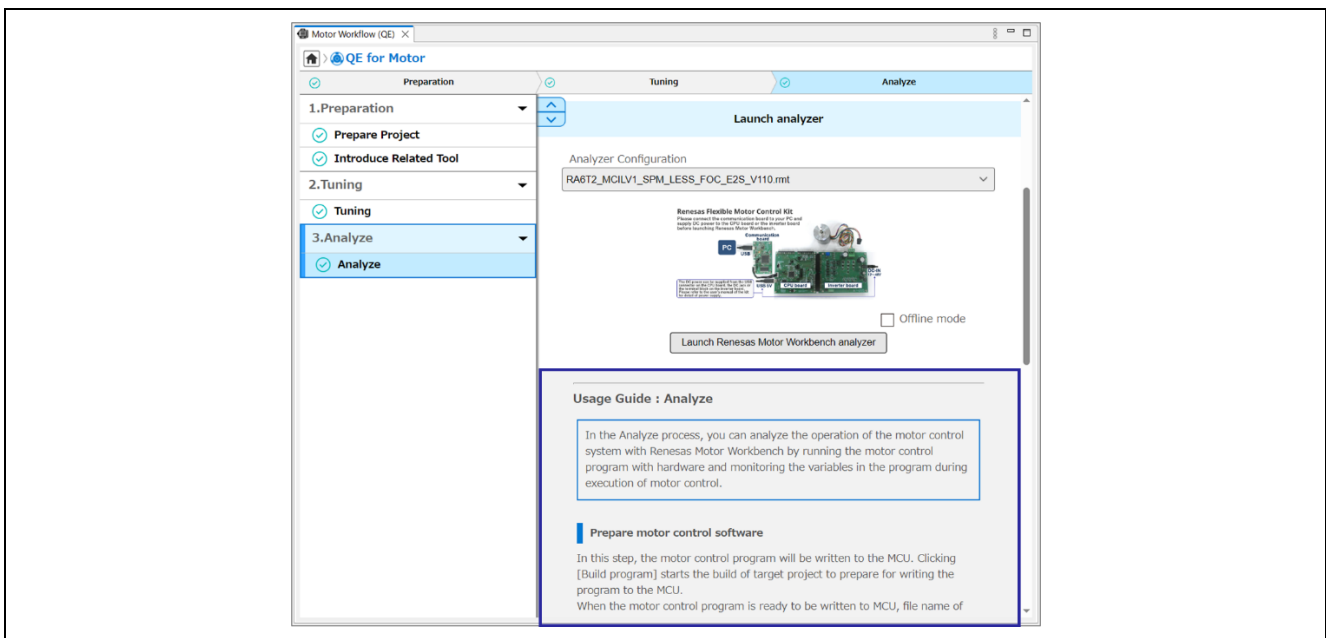

Figure 6-2 Guide function

Revision History

Rev.	Date	Description	
		Page	Summary
1.00	Jun.06.22	—	First edition
1.10	May.22.23	—	Changed the version of QE for Motor to V1.2.
1.20	Jan.30.24	—	Changed the version of QE for Motor to V1.2. Changed the version of Renesas Motor Workbench 3.1.1.
1.30	Feb.26.24	—	Added contents for RX family. Changed the version of Renesas Motor Workbench 3.1.2.
1.40	Apr.08.24	—	Added 4.1.3.2 (3) and (4) for how to modify driver configurations (RX family)

General Precautions in the Handling of Microprocessing Unit and Microcontroller Unit Products

The following usage notes are applicable to all Microprocessing unit and Microcontroller unit products from Renesas. For detailed usage notes on the products covered by this document, refer to the relevant sections of the document as well as any technical updates that have been issued for the products.

1. Precaution against Electrostatic Discharge (ESD)

A strong electrical field, when exposed to a CMOS device, can cause destruction of the gate oxide and ultimately degrade the device operation. Steps must be taken to stop the generation of static electricity as much as possible, and quickly dissipate it when it occurs. Environmental control must be adequate. When it is dry, a humidifier should be used. This is recommended to avoid using insulators that can easily build up static electricity.

Semiconductor devices must be stored and transported in an anti-static container, static shielding bag or conductive material. All test and measurement tools including work benches and floors must be grounded. The operator must also be grounded using a wrist strap. Semiconductor devices must not be touched with bare hands. Similar precautions must be taken for printed circuit boards with mounted semiconductor devices.

2. Processing at power-on

The state of the product is undefined at the time when power is supplied. The states of internal circuits in the LSI are indeterminate and the states of register settings and pins are undefined at the time when power is supplied. In a finished product where the reset signal is applied to the external reset pin, the states of pins are not guaranteed from the time when power is supplied until the reset process is completed. In a similar way, the states of pins in a product that is reset by an on-chip power-on reset function are not guaranteed from the time when power is supplied until the power reaches the level at which resetting is specified.

3. Input of signal during power-off state

Do not input signals or an I/O pull-up power supply while the device is powered off. The current injection that results from input of such a signal or I/O pull-up power supply may cause malfunction and the abnormal current that passes in the device at this time may cause degradation of internal elements. Follow the guideline for input signal during power-off state as described in your product documentation.

4. Handling of unused pins

Handle unused pins in accordance with the directions given under handling of unused pins in the manual. The input pins of CMOS products are generally in the high-impedance state. In operation with an unused pin in the open-circuit state, extra electromagnetic noise is induced in the vicinity of the LSI, an associated shoot-through current flows internally, and malfunctions occur due to the false recognition of the pin state as an input signal become possible.

5. Clock signals

After applying a reset, only release the reset line after the operating clock signal becomes stable. When switching the clock signal during program execution, wait until the target clock signal is stabilized. When the clock signal is generated with an external resonator or from an external oscillator during a reset, ensure that the reset line is only released after full stabilization of the clock signal. Additionally, when switching to a clock signal produced with an external resonator or by an external oscillator while program execution is in progress, wait until the target clock signal is stable.

6. Voltage application waveform at input pin

Waveform distortion due to input noise or a reflected wave may cause malfunction. If the input of the CMOS device stays in the area between V_{IL} (Max.) and V_{IH} (Min.) due to noise, for example, the device may malfunction. Take care to prevent chattering noise from entering the device when the input level is fixed, and also in the transition period when the input level passes through the area between V_{IL} (Max.) and V_{IH} (Min.).

7. Prohibition of access to reserved addresses

Access to reserved addresses is prohibited. The reserved addresses are provided for possible future expansion of functions. Do not access these addresses as the correct operation of the LSI is not guaranteed.

8. Differences between products

Before changing from one product to another, for example to a product with a different part number, confirm that the change will not lead to problems. The characteristics of a microprocessing unit or microcontroller unit products in the same group but having a different part number might differ in terms of internal memory capacity, layout pattern, and other factors, which can affect the ranges of electrical characteristics, such as characteristic values, operating margins, immunity to noise, and amount of radiated noise. When changing to a product with a different part number, implement a system-evaluation test for the given product.

Notice

1. Descriptions of circuits, software and other related information in this document are provided only to illustrate the operation of semiconductor products and application examples. You are fully responsible for the incorporation or any other use of the circuits, software, and information in the design of your product or system. Renesas Electronics disclaims any and all liability for any losses and damages incurred by you or third parties arising from the use of these circuits, software, or information.
2. Renesas Electronics hereby expressly disclaims any warranties against and liability for infringement or any other claims involving patents, copyrights, or other intellectual property rights of third parties, by or arising from the use of Renesas Electronics products or technical information described in this document, including but not limited to, the product data, drawings, charts, programs, algorithms, and application examples.
3. No license, express, implied or otherwise, is granted hereby under any patents, copyrights or other intellectual property rights of Renesas Electronics or others.
4. You shall be responsible for determining what licenses are required from any third parties, and obtaining such licenses for the lawful import, export, manufacture, sales, utilization, distribution or other disposal of any products incorporating Renesas Electronics products, if required.
5. You shall not alter, modify, copy, or reverse engineer any Renesas Electronics product, whether in whole or in part. Renesas Electronics disclaims any and all liability for any losses or damages incurred by you or third parties arising from such alteration, modification, copying or reverse engineering.
6. Renesas Electronics products are classified according to the following two quality grades: "Standard" and "High Quality". The intended applications for each Renesas Electronics product depends on the product's quality grade, as indicated below.
 - "Standard": Computers; office equipment; communications equipment; test and measurement equipment; audio and visual equipment; home electronic appliances; machine tools; personal electronic equipment; industrial robots; etc.
 - "High Quality": Transportation equipment (automobiles, trains, ships, etc.); traffic control (traffic lights); large-scale communication equipment; key financial terminal systems; safety control equipment; etc.

Unless expressly designated as a high reliability product or a product for harsh environments in a Renesas Electronics data sheet or other Renesas Electronics document, Renesas Electronics products are not intended or authorized for use in products or systems that may pose a direct threat to human life or bodily injury (artificial life support devices or systems; surgical implantations; etc.), or may cause serious property damage (space system; undersea repeaters; nuclear power control systems; aircraft control systems; key plant systems; military equipment; etc.). Renesas Electronics disclaims any and all liability for any damages or losses incurred by you or any third parties arising from the use of any Renesas Electronics product that is inconsistent with any Renesas Electronics data sheet, user's manual or other Renesas Electronics document.
7. No semiconductor product is absolutely secure. Notwithstanding any security measures or features that may be implemented in Renesas Electronics hardware or software products, Renesas Electronics shall have absolutely no liability arising out of any vulnerability or security breach, including but not limited to any unauthorized access to or use of a Renesas Electronics product or a system that uses a Renesas Electronics product. RENESAS ELECTRONICS DOES NOT WARRANT OR GUARANTEE THAT RENESAS ELECTRONICS PRODUCTS, OR ANY SYSTEMS CREATED USING RENESAS ELECTRONICS PRODUCTS WILL BE INVULNERABLE OR FREE FROM CORRUPTION, ATTACK, VIRUSES, INTERFERENCE, HACKING, DATA LOSS OR THEFT, OR OTHER SECURITY INTRUSION ("Vulnerability Issues"). RENESAS ELECTRONICS DISCLAIMS ANY AND ALL RESPONSIBILITY OR LIABILITY ARISING FROM OR RELATED TO ANY VULNERABILITY ISSUES. FURTHERMORE, TO THE EXTENT PERMITTED BY APPLICABLE LAW, RENESAS ELECTRONICS DISCLAIMS ANY AND ALL WARRANTIES, EXPRESS OR IMPLIED, WITH RESPECT TO THIS DOCUMENT AND ANY RELATED OR ACCOMPANYING SOFTWARE OR HARDWARE, INCLUDING BUT NOT LIMITED TO THE IMPLIED WARRANTIES OF MERCHANTABILITY, OR FITNESS FOR A PARTICULAR PURPOSE.
8. When using Renesas Electronics products, refer to the latest product information (data sheets, user's manuals, application notes, "General Notes for Handling and Using Semiconductor Devices" in the reliability handbook, etc.), and ensure that usage conditions are within the ranges specified by Renesas Electronics with respect to maximum ratings, operating power supply voltage range, heat dissipation characteristics, installation, etc. Renesas Electronics disclaims any and all liability for any malfunctions, failure or accident arising out of the use of Renesas Electronics products outside of such specified ranges.
9. Although Renesas Electronics endeavors to improve the quality and reliability of Renesas Electronics products, semiconductor products have specific characteristics, such as the occurrence of failure at a certain rate and malfunctions under certain use conditions. Unless designated as a high reliability product or a product for harsh environments in a Renesas Electronics data sheet or other Renesas Electronics document, Renesas Electronics products are not subject to radiation resistance design. You are responsible for implementing safety measures to guard against the possibility of bodily injury, injury or damage caused by fire, and/or danger to the public in the event of a failure or malfunction of Renesas Electronics products, such as safety design for hardware and software, including but not limited to redundancy, fire control and malfunction prevention, appropriate treatment for aging degradation or any other appropriate measures. Because the evaluation of microcomputer software alone is very difficult and impractical, you are responsible for evaluating the safety of the final products or systems manufactured by you.
10. Please contact a Renesas Electronics sales office for details as to environmental matters such as the environmental compatibility of each Renesas Electronics product. You are responsible for carefully and sufficiently investigating applicable laws and regulations that regulate the inclusion or use of controlled substances, including without limitation, the EU RoHS Directive, and using Renesas Electronics products in compliance with all these applicable laws and regulations. Renesas Electronics disclaims any and all liability for damages or losses occurring as a result of your noncompliance with applicable laws and regulations.
11. Renesas Electronics products and technologies shall not be used for or incorporated into any products or systems whose manufacture, use, or sale is prohibited under any applicable domestic or foreign laws or regulations. You shall comply with any applicable export control laws and regulations promulgated and administered by the governments of any countries asserting jurisdiction over the parties or transactions.
12. It is the responsibility of the buyer or distributor of Renesas Electronics products, or any other party who distributes, disposes of, or otherwise sells or transfers the product to a third party, to notify such third party in advance of the contents and conditions set forth in this document.
13. This document shall not be reprinted, reproduced or duplicated in any form, in whole or in part, without prior written consent of Renesas Electronics.
14. Please contact a Renesas Electronics sales office if you have any questions regarding the information contained in this document or Renesas Electronics products.

(Note1) "Renesas Electronics" as used in this document means Renesas Electronics Corporation and also includes its directly or indirectly controlled subsidiaries.

(Note2) "Renesas Electronics product(s)" means any product developed or manufactured by or for Renesas Electronics.

(Rev.5.0-1 October 2020)

Corporate Headquarters

TOYOSU FORESIA, 3-2-24 Toyosu,
Koto-ku, Tokyo 135-0061, Japan
www.renesas.com

Trademarks

Renesas and the Renesas logo are trademarks of Renesas Electronics Corporation. All trademarks and registered trademarks are the property of their respective owners.

Contact information

For further information on a product, technology, the most up-to-date version of a document, or your nearest sales office, please visit:
www.renesas.com/contact/.