

## RL78/G22

### Capacitive Touch Low Power Guide (SMS / MEC function)

---

#### Introduction

This application note describes how to use SNOOZE Mode Sequencer (SMS) and Multiple Electrode Connection (MEC) function to achieve low power consumption when measuring capacitance touch.

#### Target Device

RL78/G22

When applying the contents of this application note to other MCUs, please change them according to the specifications of the MCUs and perform a thorough evaluation.

**Contents**

1. Outline.....	3
2. Used Peripherals .....	3
3. Operation Environment / Conditions .....	4
4. Capacitive touch settings.....	6
4.1 Touch interface configuration .....	6
4.2 Method settings .....	6
5. Used components.....	7
6. Touch measurement software operation.....	8
6.1 Operation Image of CPU and CTSU .....	9
7. Sample Project flow chart .....	10
7.1 Main processing .....	10
7.2 Touch measurement initial processing.....	11
7.3 Touch Measurement Control Processing in Low power consumption mode .....	14
7.4 Touch Measurement Control Processing in Normal Mode .....	16
8. How to measure current consumption .....	18
8.1 Environment to Measure Current Consumption.....	18
8.2 Equipment and Software .....	18
8.3 How to connect the target board and each equipment .....	19
8.4 RL78/G22 Capacitive Touch Evaluation System CPU Board .....	20
8.5 Settings of current measuring software.....	21
9. Current consumption measurement result .....	22
9.1 Current consumption waveform in intermittent operation.....	22
9.2 Current Consumption When Transiting to CPU (Touch Measurement Using SMS/MEC) .....	22
9.3 Current Consumption Calculation (Touch-Measurement Using SMS/MEC) .....	23
10. Related Document.....	24
Website and Support .....	24
Revision History.....	25

## 1. Outline

This application note shows the reference current consumption when the capacitive touch measurement using SNOOZE Mode Sequencer (SMS) function and MEC function of RL78/G22 is operated intermittently in 100ms cycles. By using SMS function and Multiple Electrode Connection (MEC) function, the touch on/off status of several electrodes can be determined during SNOOZE mode, enabling low power consumption.

### ※ SNOOZE Mode Sequencer (SMS)

This function sequentially executes up to 32 processes from 21 types of processing such as arithmetic processing, branch processing, and control of peripheral functions (timer, serial communication, etc.). SMS is activated by the interrupt-request signal of the peripheral function or the output signal of ELC, and the process can be executed independently of CPU. Therefore, SMS can operate even when CPU is in stand-by. In addition, since the operating current of SMS is smaller than that of CPU, CPU can be replaced by a process to reduce power consumption.

### ※ Multiple Electrode Connection (MEC) Function

This function connects multiple electrodes and measures them as a single electrode. This function is only available in self-capacitance mode.

This sample program measures three buttons (consisting of three electrodes) and one slider (consisting of five electrodes) and one wheel (consisting of four electrodes) in the normal mode. In low power consumption mode, the SMS function used and MEC function is used to measure twelve electrodes as one electrode.

## 2. Used Peripherals

Table 2-1 lists the used peripherals in the sample code.

**Table 2-1 Peripherals in the sample code**

Used Peripherals	Functions
Capacitive Sensing Unit (CTS2U2La)	Measures electrostatic capacitance of the touch sensor.
32-bit interval timer (TML32)	Timer to release STOP mode and transition to SNOOZE mode (measurement cycle: 100 ms).
Data transfer controller (DTC)	Port output using DTC from CTS2U2La. <sup>Note1</sup>
Port	An interrupt signal is generated using the signal output from the port. <sup>Note2</sup>
Interrupt Controller (INTP)	
Event Link Controller (ELC)	
SNOOZE Mode Sequencer (SMS)	An interrupt signal triggers the ELC to start SMS processing.

Note 1. DTC transfer rewrites the port register (Pxx) in 8-bit units. Therefore, while automatic judgment measurement processing using SMS is being executed, the port register (Pxx), which is the DTC transfer destination, cannot be used for other functions. Select the port register (Pxx) to be used to avoid conflicts with other systems.

Note 2. This is a process for performing automatic judgment measurement using SMS with RL78/G22. Please connect the port pin (Pxx) used in this process and the external interrupt pin (INTPxx). For the wiring method, see "Figure 8-4 Pins of CPU board connected to the digital multimeter."

### 3. Operation Environment / Conditions

Table 3-1 lists the operating conditions, Table 3-2 lists the operating conditions, and Figure 3-1 shows CTSU measurement touch sensor, sensor drive pulse frequency, and CTSU measurement times.

Note: In QE for Capacitive Touch V3.5.0, the display of the threshold of the button/wheel/slider of config01 in Figure 3-1 is incorrect. Out of the three displayed threshold, the correct value is twice the first threshold.

**Table 3-1 Operation environment**

Item	Contents
MCU	RL78/G22 (R7F102GGE2DFB)
Operating voltage	5.0 V LVD0 detection voltage: Reset mode At rising edge TYP. 2.67V (2.59 V~2.75 V) At falling edge TYP. 2.62V (2.54 V~2.70 V)
Target board	RL78/G22 capacitive touch evaluation system (RTK0EG0042S01001BJ)
Integrated development environment	e <sup>2</sup> studio (2024-04)
Smart Configurator	V24.4.0
C compiler	CC-RL V1.13.00
QE for Capacitive Touch	V3.5.0
Debugger	E2 emulator Lite

**Table 3-2 Operation conditions**

Item	Contents
High-speed on-chip oscillator clock (fIH)	6MHz *Note
CPU/peripheral hardware clock (fCLK)	6MHz *Note
Low-speed on-chip oscillator clock (fIL)	32.768 kHz
Low-speed peripheral clock (fSXP)	32.768 kHz
Capacitive Touch measurement cycle	20 ms (Normal mode)/100 ms (Low power consumption mode)
Measurement Mode Select 1 [MD1]	Self-capacitance method (single measurement)
Measurement Mode Select 0 [MD0]	Multi-scan mode
Measurement Start Trigger Select [CAP]	External trigger (ELC)
SNOOZE Enable [SNZ]	Enables the SNOOZE mode
Analog Adjustment 0 [ATUNE0]	Measurement power-supply voltage = 1.5 V (Normal voltage operating mode)
Analog Adjustment 1 [ATUNE1]	40 μA
Sensor Stabilization Wait Time Setting	64 μs (Recommended value)
Multi-clock x Enable [MCAx]	3 frequencies (MCA0, MCA1, MCA2: Available)

Note : Operation is not supported when fIH or fCLK is set to 4 MHz or lower.

Automatic judgment measurement using SMS supports only button touch detection (slider/wheel touch position detection is not supports). Therefore, this sample program measures buttons, sliders, and wheels in normal mode (config01: software judgment), and measures twelve electrodes as one electrode in low power consumption mode (config02: automatic judgment (SMS+MEC)). For details on touch interface configuration, please also refer to "4 Capacitive touch settings".

Method	Kind	Name	Touch Sensor	Parasitic Capacitance[pF]	Sensor Drive Pulse Frequency[MHz]	Threshold	Scan Time[ms]	Overflow
config01	Button(self)	Mec00	TS00	163.146	0.5	179, 152, 205	0.576	None
config02	Button(self)	Button00	TS28	21.958	2.0	636, 543, 728	0.576	None
config02	Button(self)	Button01	TS18	20.417	2.0	610, 521, 699	0.576	None
config02	Button(self)	Button02	TS00	20.938	2.0	604, 515, 692	0.576	None
config02	Wheel	Wheel00	TS19, TS08, TS24, TS21	-	-	256, 219, 293	-	None
config02	Wheel TS	(Wheel00)	TS19	23.986	1.0	-	0.576	-
config02	Wheel TS	(Wheel00)	TS08	25.785	1.0	-	0.576	-
config02	Wheel TS	(Wheel00)	TS24	24.319	1.0	-	0.576	-
config02	Wheel TS	(Wheel00)	TS21	23.535	1.0	-	0.576	-
config02	Slider	Slider00	TS04, TS05, TS06, TS07, TS01	-	-	349, 298, 399	-	None
config02	Slider TS	(Slider00)	TS04	16.882	2.0	-	0.576	-
config02	Slider TS	(Slider00)	TS05	18.549	2.0	-	0.576	-
config02	Slider TS	(Slider00)	TS06	19.167	2.0	-	0.576	-
config02	Slider TS	(Slider00)	TS07	20.049	2.0	-	0.576	-
config02	Slider TS	(Slider00)	TS01	22.333	2.0	-	0.576	-

Figure 3-1 CTSU measurement Touch sensor and Sensor Drive Pulse Frequency and CTSU Scan Time

Table 3-3 Option Byte Settings

Address	Setting Value	Contents
000C0H/020C0H	11101111B (0xEF)	Disables the watchdog timer. (Counting stopped after reset)
000C1H/020C1H	11111100B (0xFC)	LVD0 detection voltage: reset mode At rising edge TYP. 2.67V (2.59 V~2.75 V) At falling edge TYP. 2.62V (2.54 V~2.70 V)
000C2H/020C2H	11100010B (0xE2)	HS mode, High-speed on-chip oscillator clock (flH): 6 MHz
000C3H/020C3H	10000100B (0x84)	Enables on-chip debugging

To set the option byte, open the project properties after code generation, "C/C++ Build" -> "Settings" -> "Tool Settings" -> "Linker" -> "Device" -> "User option byte value" and "On-chip debug control value".

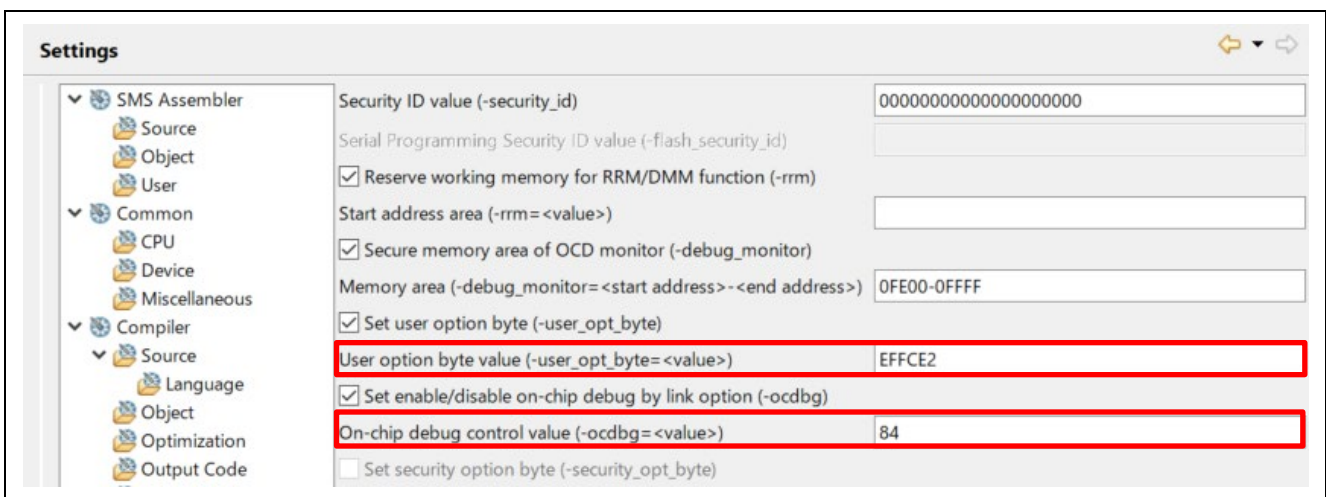

## 4. Capacitive touch settings

### 4.1 Touch interface configuration

Figure 4-1 shows the touch interface configuration. config01 is the Normal mode and config02 is the Low Power Consumption mode.

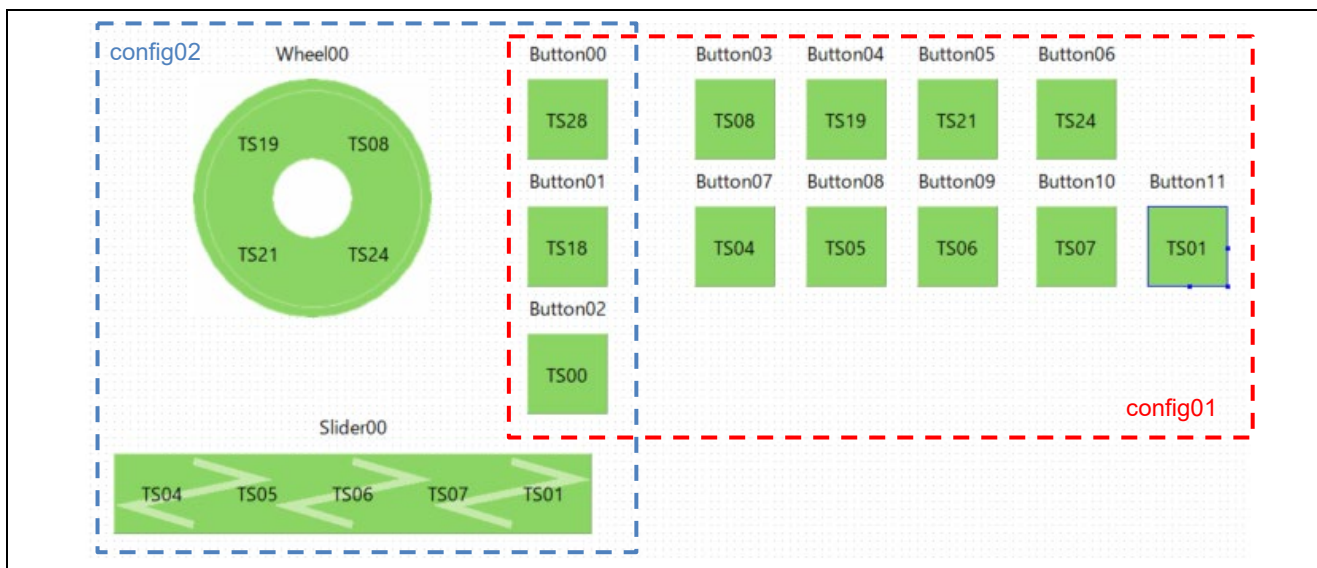

Figure 4-1 Touch interface configuration

### 4.2 Method settings

Figure 4-2 shows the touch interface configuration method settings. SMS function and MEC function is used by enabling Auto Judgement by Hardware and Multiple Electrode Connection.

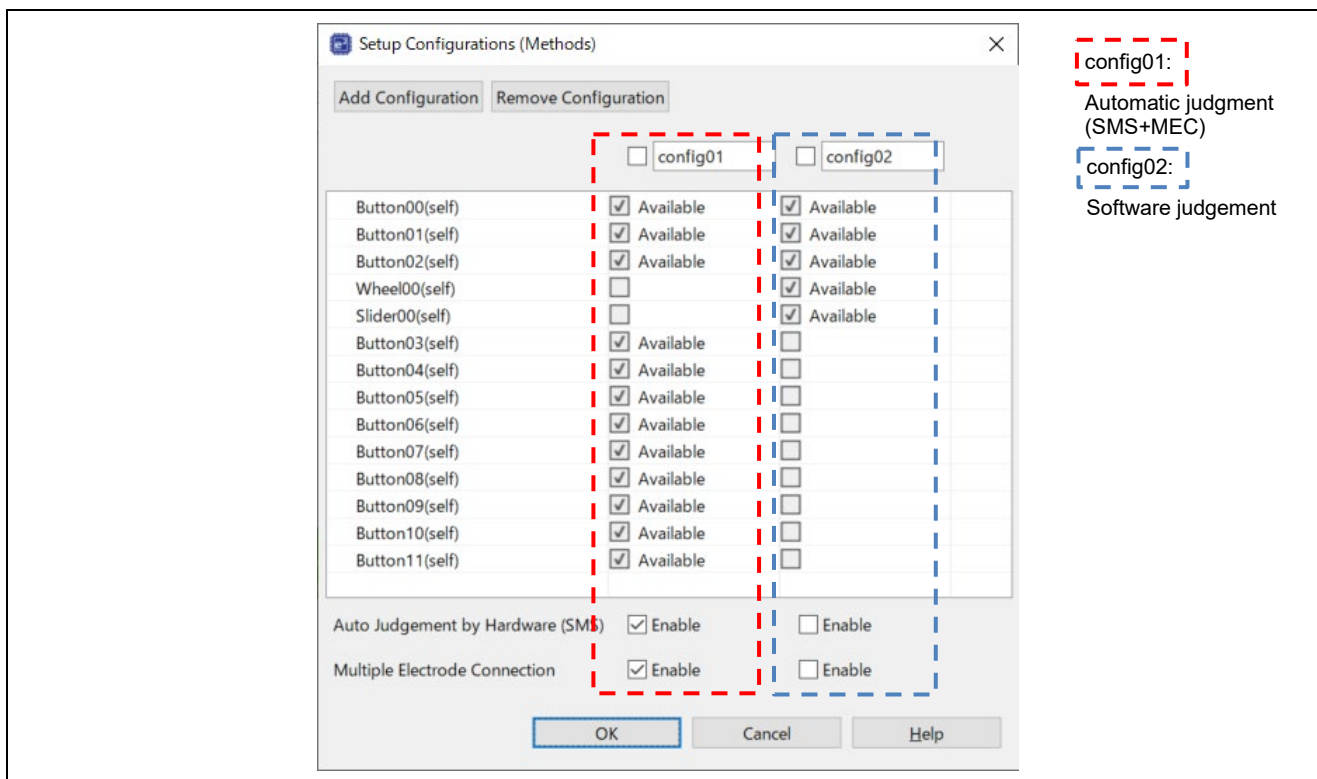

Figure 4-2 Method settings

Note: If you want to enable Auto Judgement by Hardware (SMS) using CTSU driver V1.50, please set the touch interface configuration in config01.

### 5. Used components

Figure 5-1 shows the components used in Smart Configurator.

Selected components:

Component	Version	Configuration
✔ Board Support Packages. - v1.62 (r_bsp)	1.62	r_bsp(used)
✔ Capacitive Sensing Unit driver. (r_ctsu)	1.50	r_ctsu(used)
✔ Interrupt Controller	1.4.0	Config_INTC(INTC: used)
✔ Interval Timer	1.4.0	Config_ITL000(ITL000: used), Config_TAU0_1(TAU0_1: used)
✔ Ports	1.4.1	Config_PORT(PORT: used)
✔ Touch middleware. (rm_touch)	1.50	rm_touch(used)
✔ Voltage Detector	1.3.0	Config_LVD0(LVD0: used)

Figure 5-1 Components

## 6. Touch measurement software operation

This section describes the sample project operation overview.

===== Up to initial offset tuning =====

1. Executes RM\_TOUCH\_Open function. After the reset is released by power-on, CTSU is initialized.
2. ELC sets CTSU as the link destination for the compare match of the event source 32-bit interval timer 0.
3. Execute RM\_TOUCH\_ScanStart to set the touch measurement and wait for external trigger.
4. TML32 timer counting starts (measurement cycle: 20 ms).
5. When STOP instruction is executed, the unit transits to STOP.
6. When an interrupt of TML32 is generated, touch measurement is started by entering SNOOZE mode by an external trigger from ELC.
7. By the measurement end interrupt, the mode transitions to Normal mode and touch on/off judgment is performed. Touch-Measurement Using SMS, MEC (Low Power Consumption mode Use)
8. Execute initial offset tuning.

===== Touch-Measurement Using SMS, MEC (Low Power Consumption mode Use) =====

9. After baseline initialization, set SMS by executing RM\_TOUCH\_SmsSet.
10. The touch measurement setting and SNOOZE function are enabled by executing RM\_TOUCH\_ScanStart function. Then, the external trigger wait status is set.
11. Starts counting of TML32 timer (measurement cycle: 100 ms).
12. When STOP instruction is executed, the unit transits to STOP.
13. When an interrupt of TML32 is generated, touch measurement is started by entering SNOOZE mode by an external trigger from ELC.
14. When a measurement end interrupt is generated, touch on/off judgment is made by SMS while in SNOOZE mode.
15. Transits to Normal mode at touch-on judgment. When touch-off judgment is made, the display returns to 12.

===== Touch measurement of buttons/sliders/wheels (Normal mode)  
=====

16. Execute RM\_TOUCH\_ScanStart to wait for an external trigger.
17. TML32 timer counting starts (measurement cycle: 20 ms).
18. Touch-measurement is performed by an external trigger from ELC after TML32 timer count has elapsed 20ms.
19. After the touch measurement is finished, the touch on/off judgment and LED lighting are executed from the slider and wheel touch position.
20. When touch-on judgment or slider and wheel touch position is detected, repeats from 18 to 19. When touch-on judgment and detection of slider and wheel touch position are not performed for 3 seconds, transition to 9.



### 6.1 Operation Image of CPU and CTSU

Figure 6-1 shows an image of CPU operation and CTSU operation status during touch measurement using SMS.

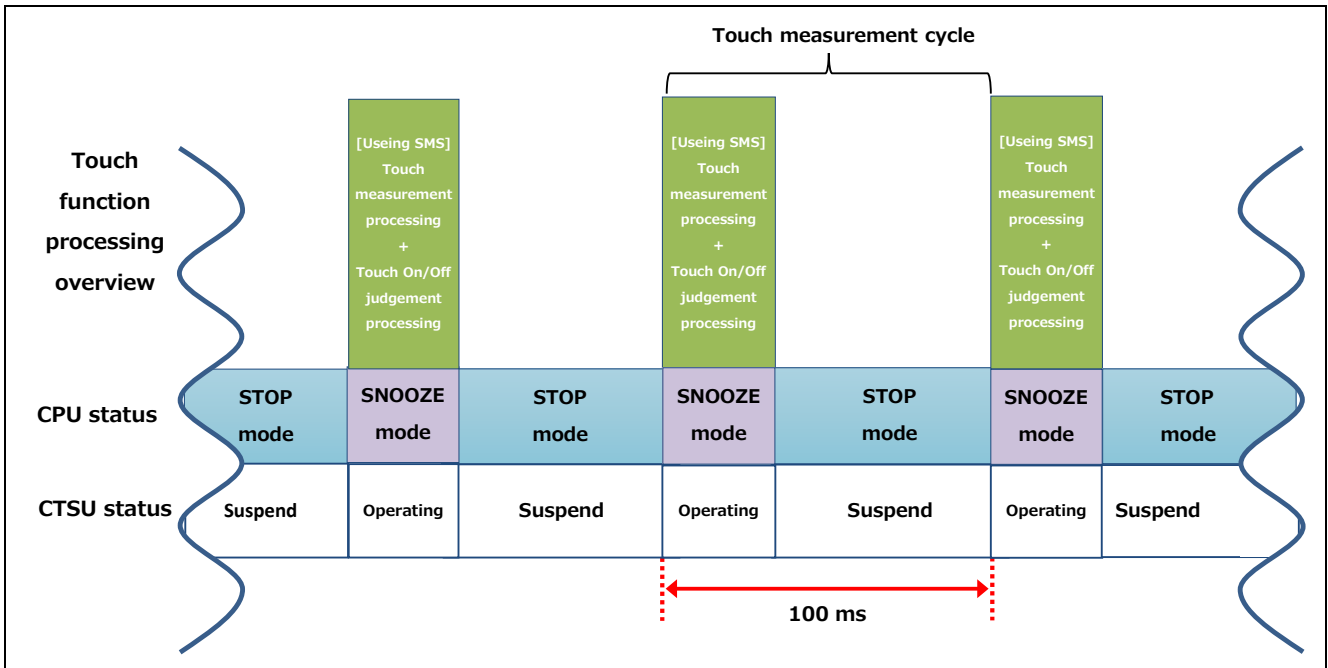

Figure 6-1 Operation image when measuring touch using SMS (When determining touch-off)

## 7. Sample Project flow chart

The flow chart of the sample project is described below.

### 7.1 Main processing

Figure 7-1 shows the flowchart of main processing.

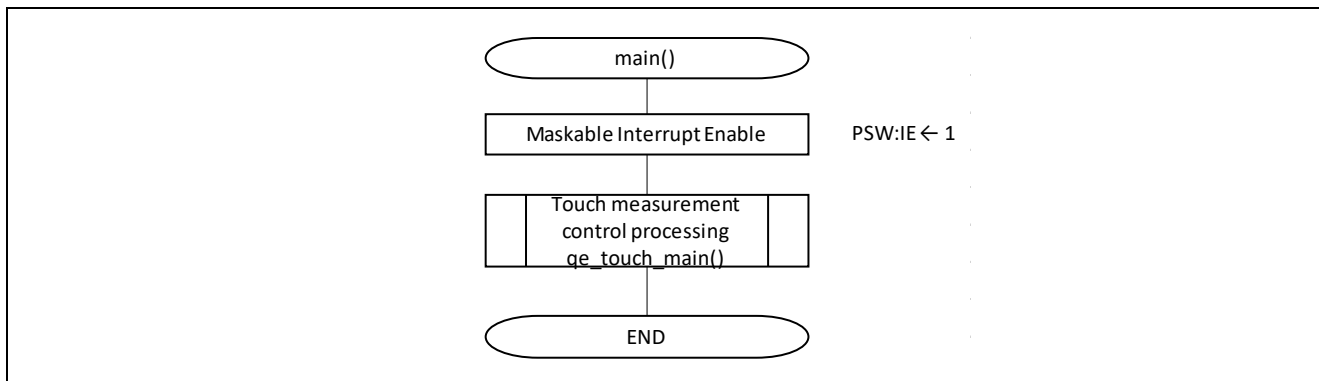

Figure 7-1 Flowchart of main processing

## 7.2 Touch measurement initial processing

Figure 7-2, Figure 7-3, and Figure 7-4 show the flowchart of touch measurement initial processing.

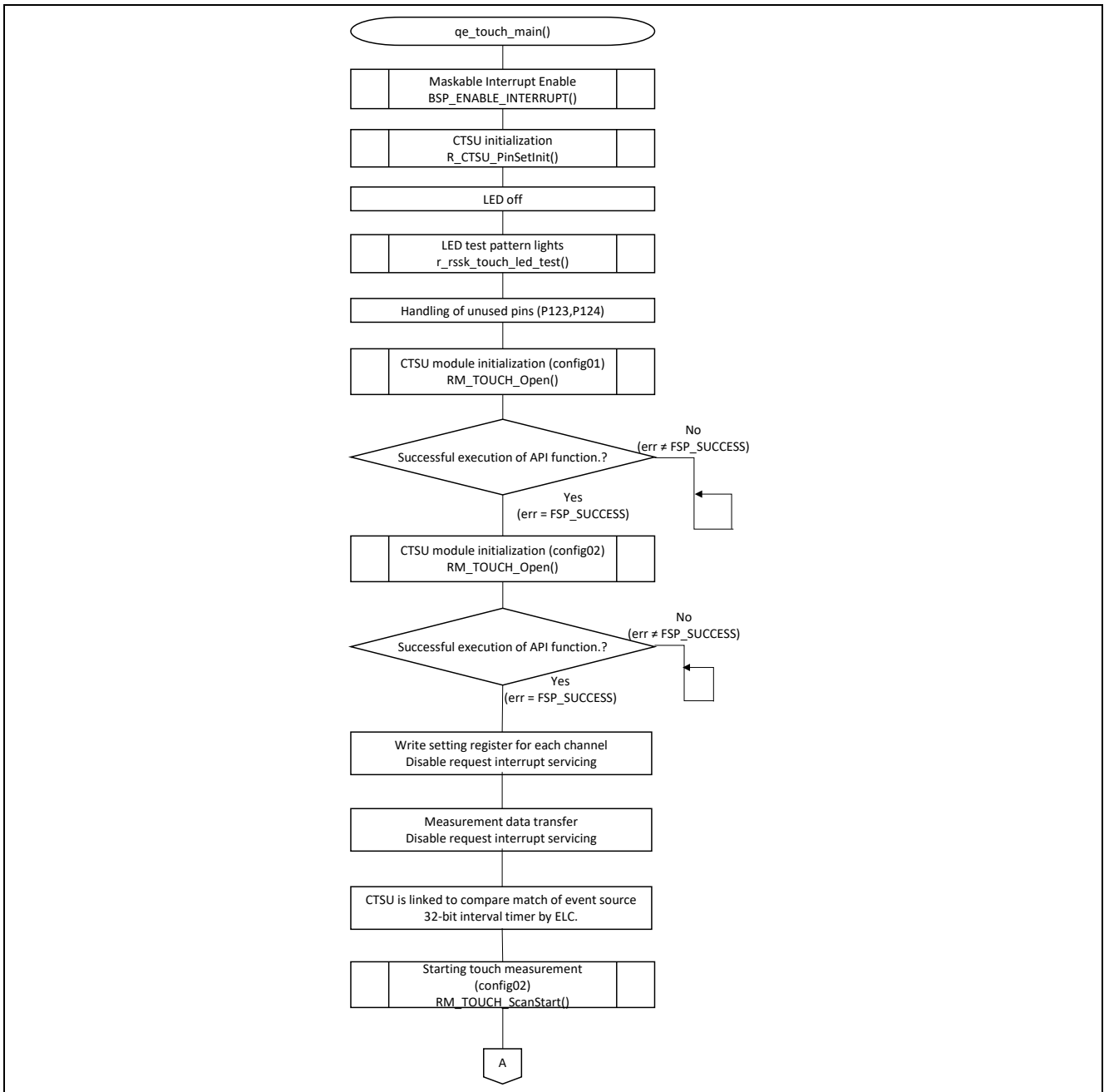

Figure 7-2 Touch measurement initial processing (1/3)

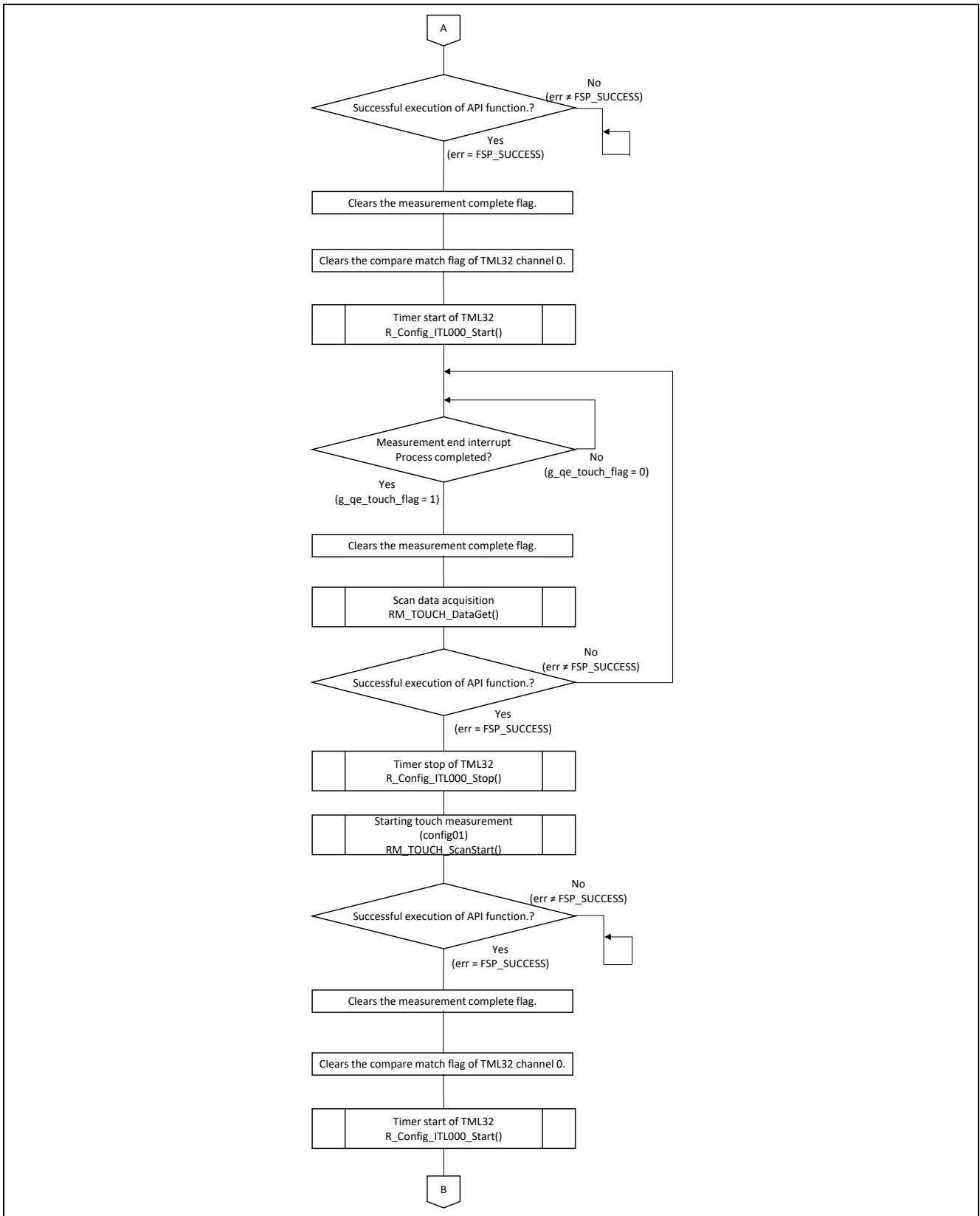

Figure 7-3 Touch measurement initial processing (2/3)

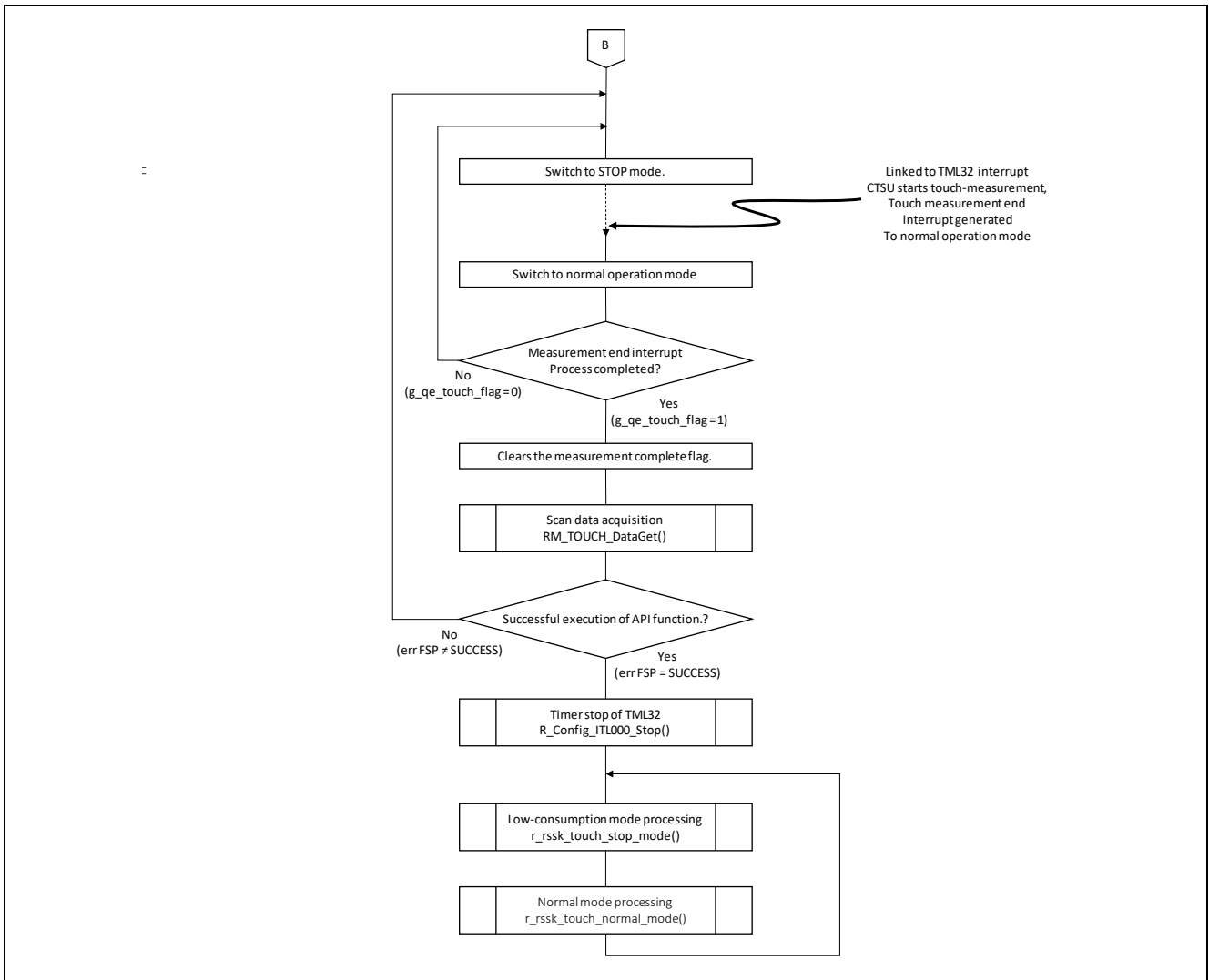

Figure 7-4 Touch measurement initial processing (3/3)

### 7.3 Touch Measurement Control Processing in Low power consumption mode

Figure 7-5 and Figure 7-6 show the flowchart of touch measurement control processing in low power consumption mode.

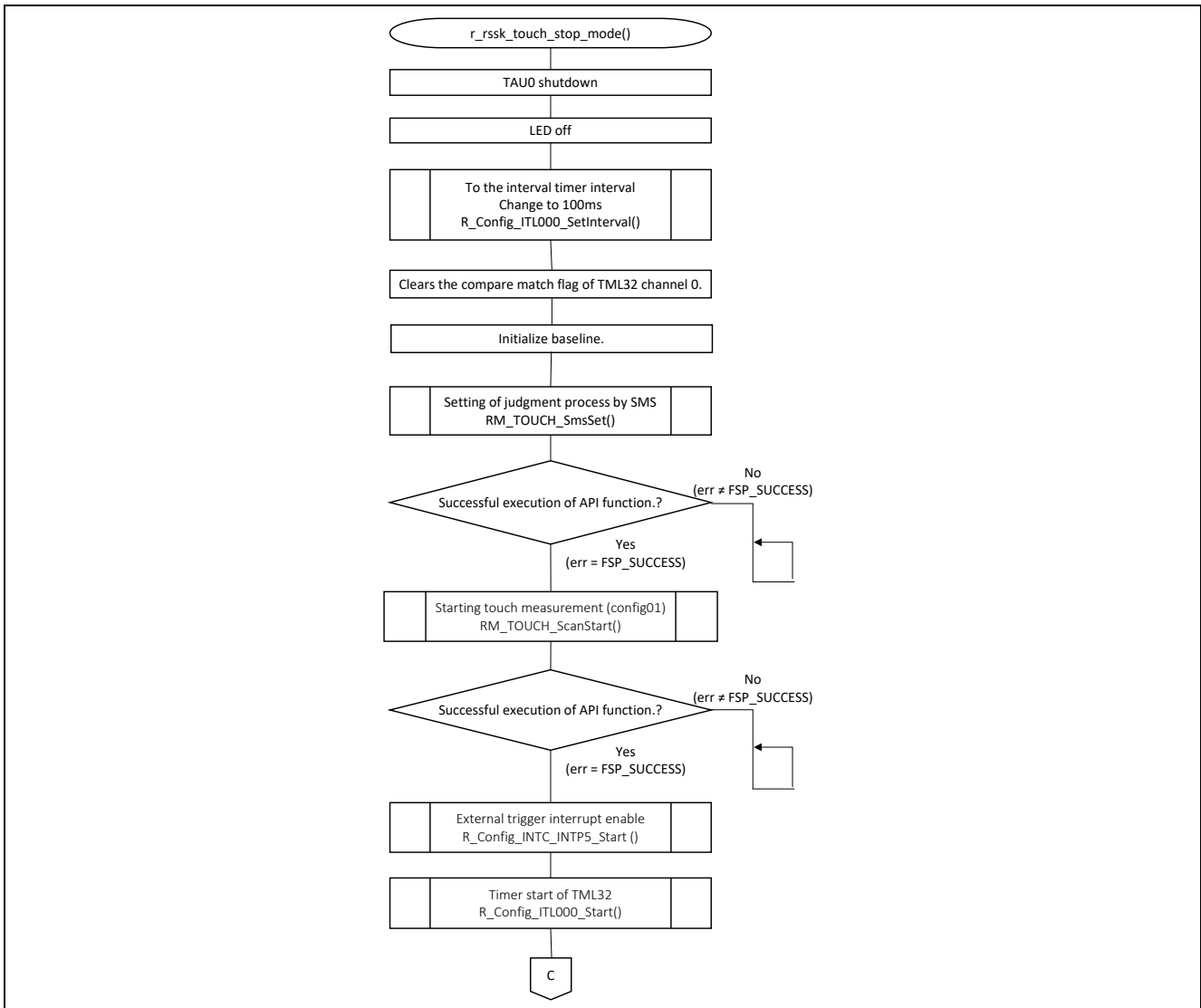

Figure 7-5 Touch Measurement Control Processing in Low Power Consumption Mode (1/2)

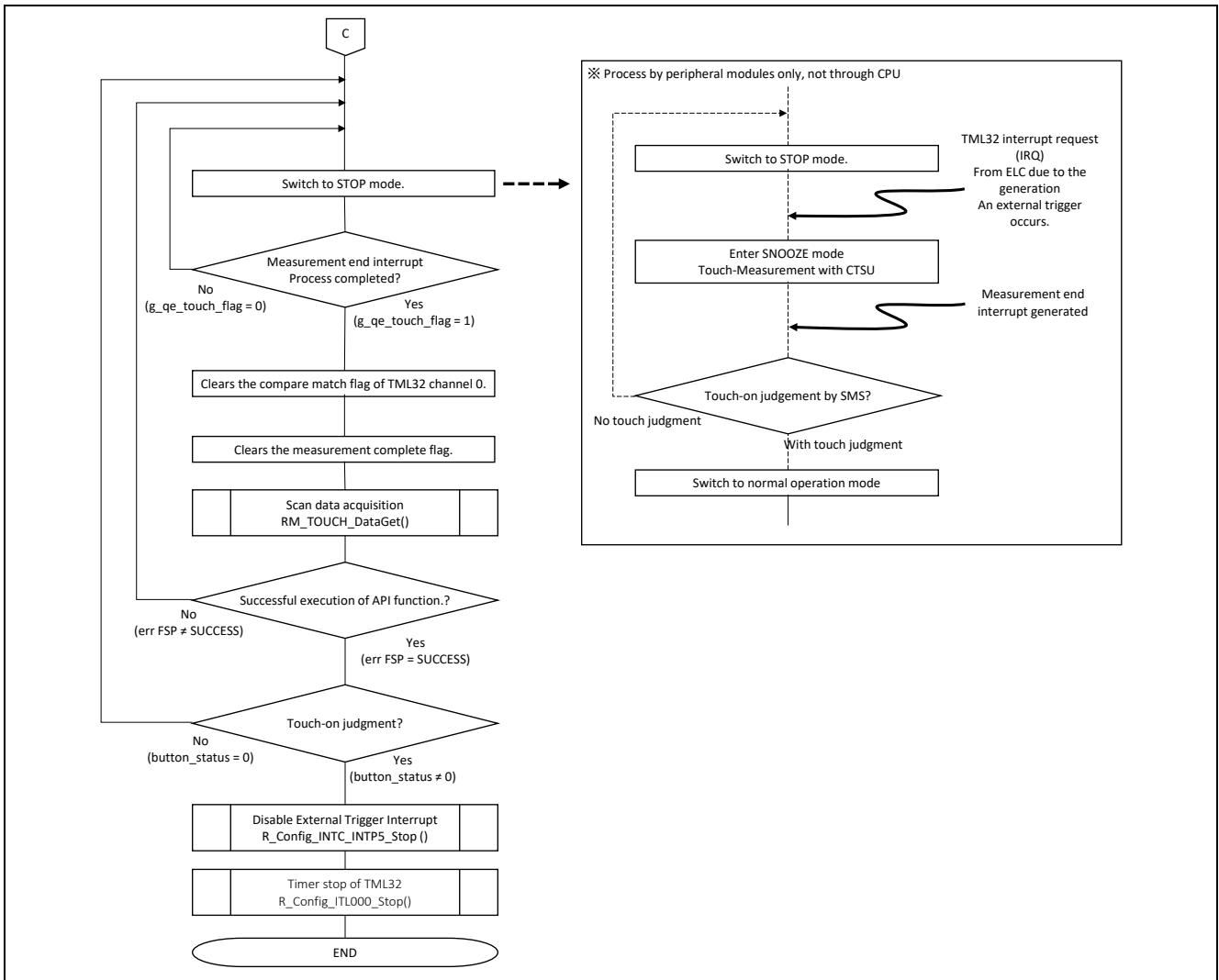

Figure 7-6 Touch Measurement Control Processing in Low Consumption Mode (2/2)

### 7.4 Touch Measurement Control Processing in Normal Mode

Figure 7-7 and Figure 7-8 show the flowchart of touch measurement control processing in normal mode.

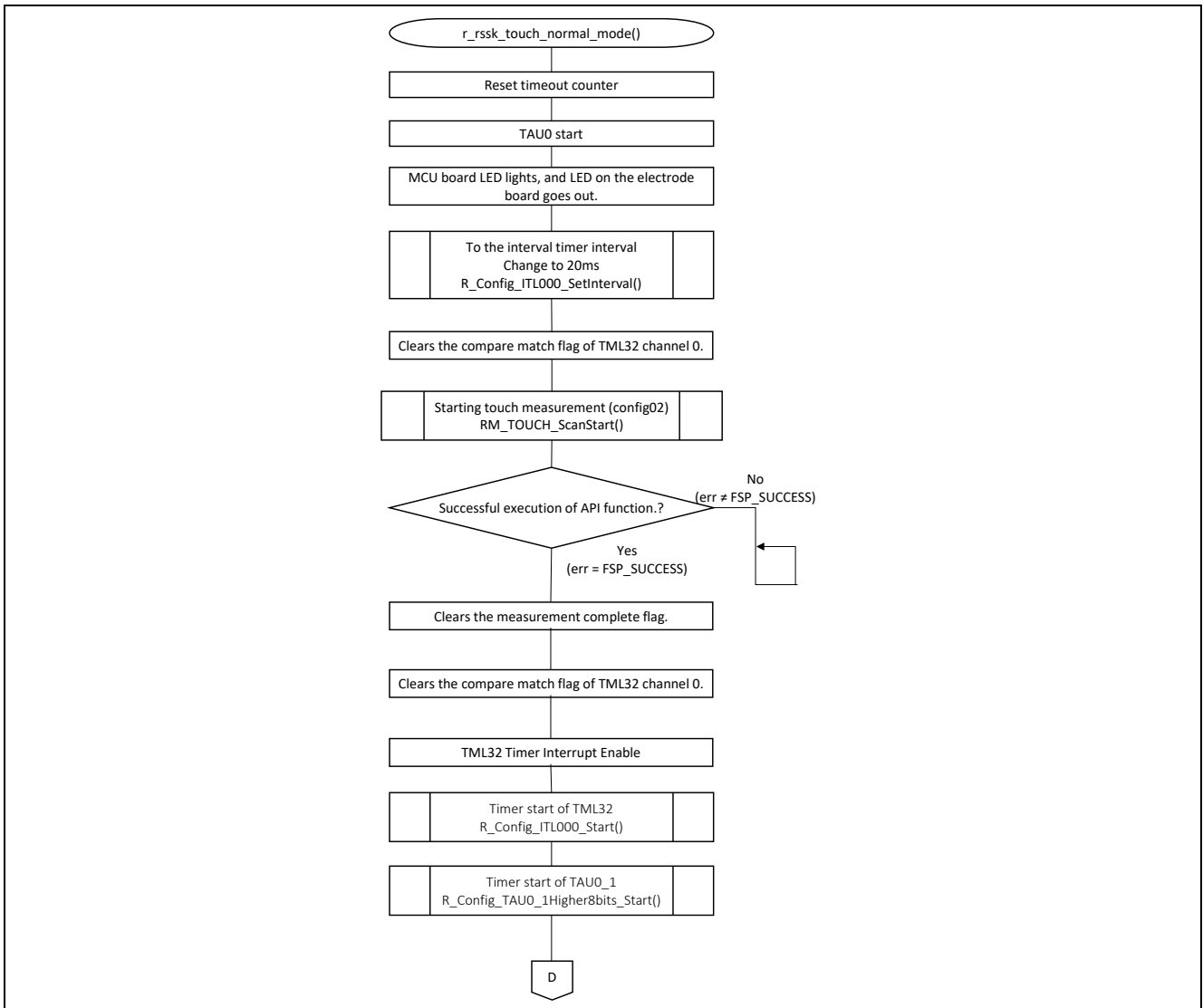

Figure 7-7 Touch Measurement Control Processing in Normal Mode (1/2)



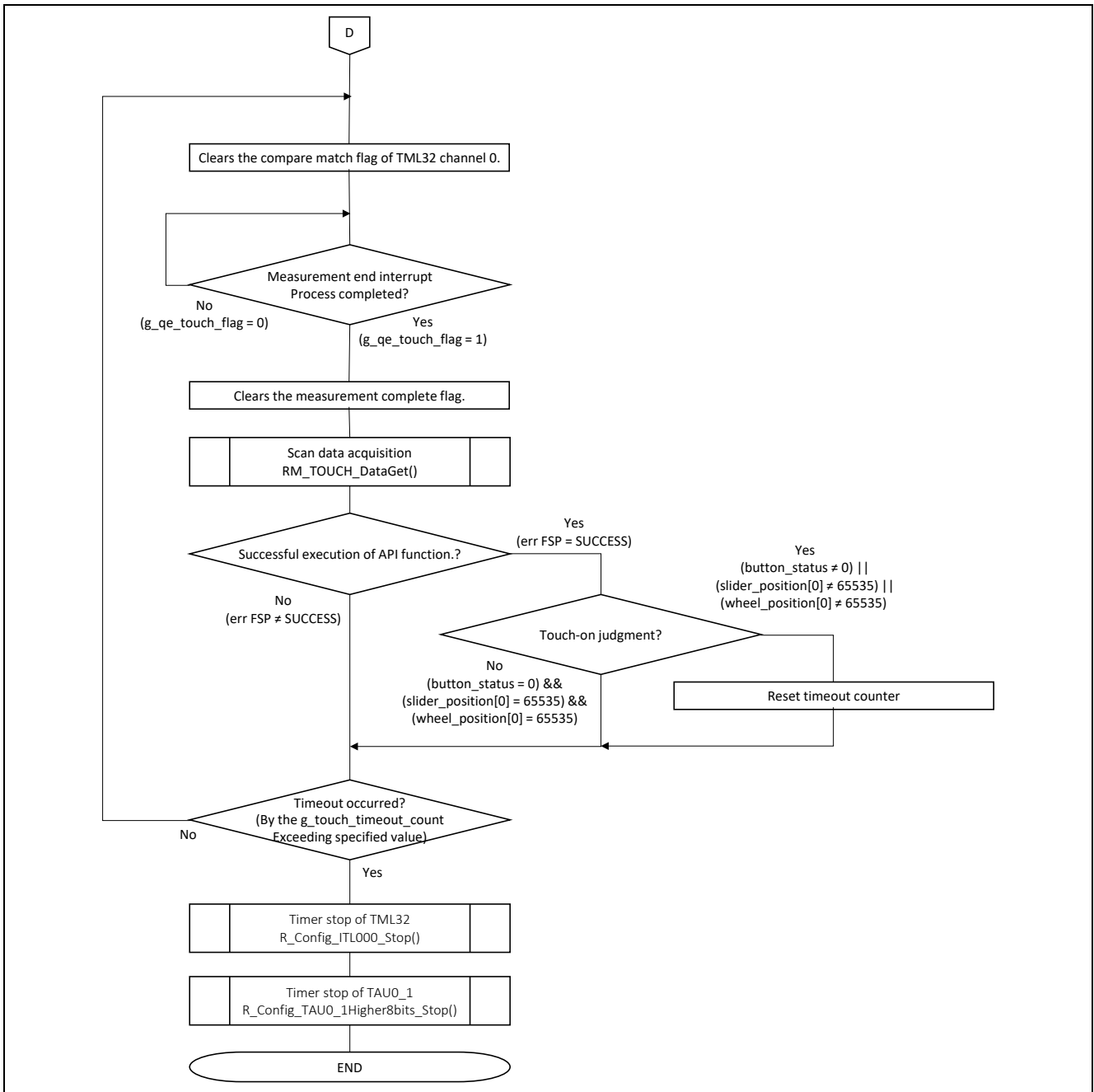

Figure 7-8 Touch Measurement Control Processing in Normal Mode (2/2)

## 8. How to measure current consumption

### 8.1 Environment to Measure Current Consumption

Figure 8-1 shows environment to measure current consumption.

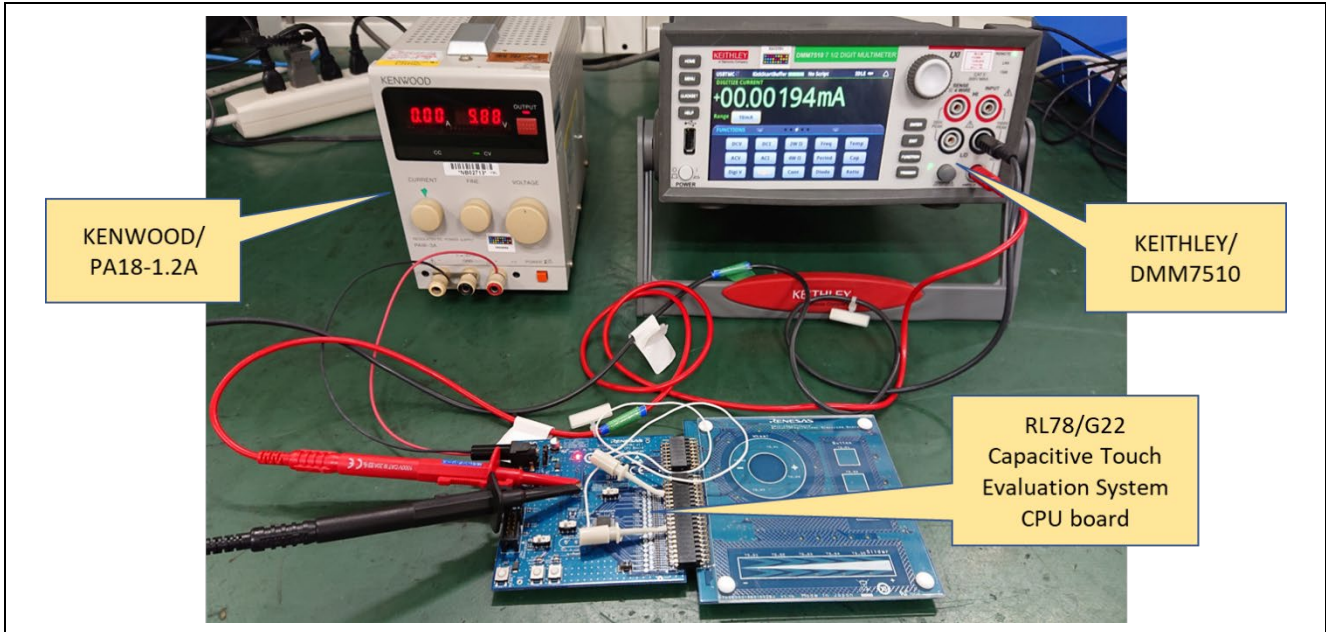

Figure 8-1 Environment to measure current consumption

### 8.2 Equipment and Software

Table 8-1 shows equipment and software used in current consumption measurement.

Table 8-1 Current measuring equipment and Software

Type	Name	Use
Digital multi meter	KEITHLEY/DMM7510	Measure current consumption.
DC power supply	KENWOOD/PA18-1.2A	Supply power to RL78/G22 Capacitive Touch Evaluation System CPU board(RTK0EG0042S01001BJ).
Software	KEITHLEY/KickStart Software	Get result of current consumption measurement from Keithley DMM7510 and output the result to log-file.

### 8.3 How to connect the target board and each equipment

Figure 8-2 shows how to connect the RL78/G22 capacitive touch evaluation system CPU board and each equipment, and Figure 8-3 shows the power supply system diagram for the RL78/G22 capacitive touch evaluation system CPU board.

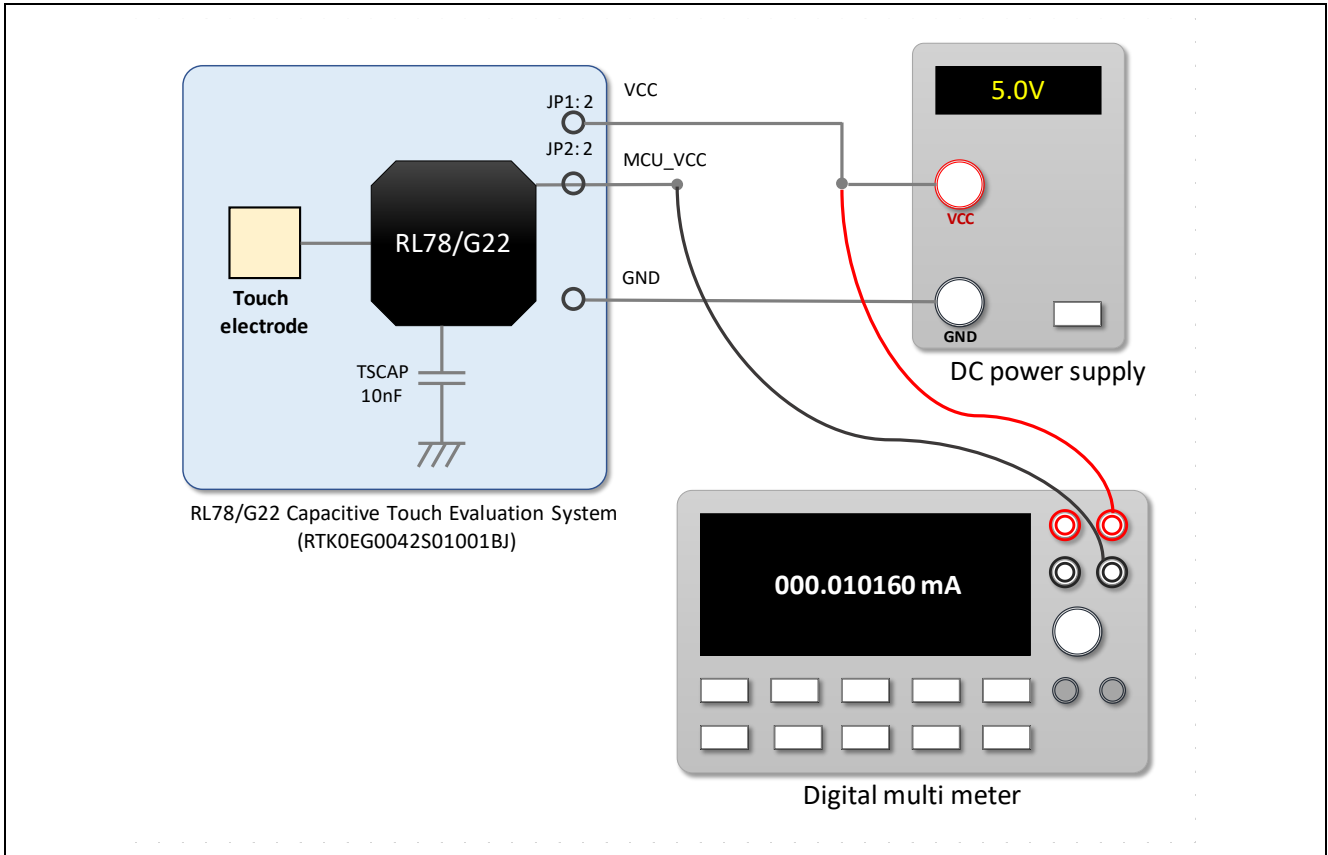

Figure 8-2 Connect the RL78/G22 capacitive touch evaluation system CPU board and each equipment

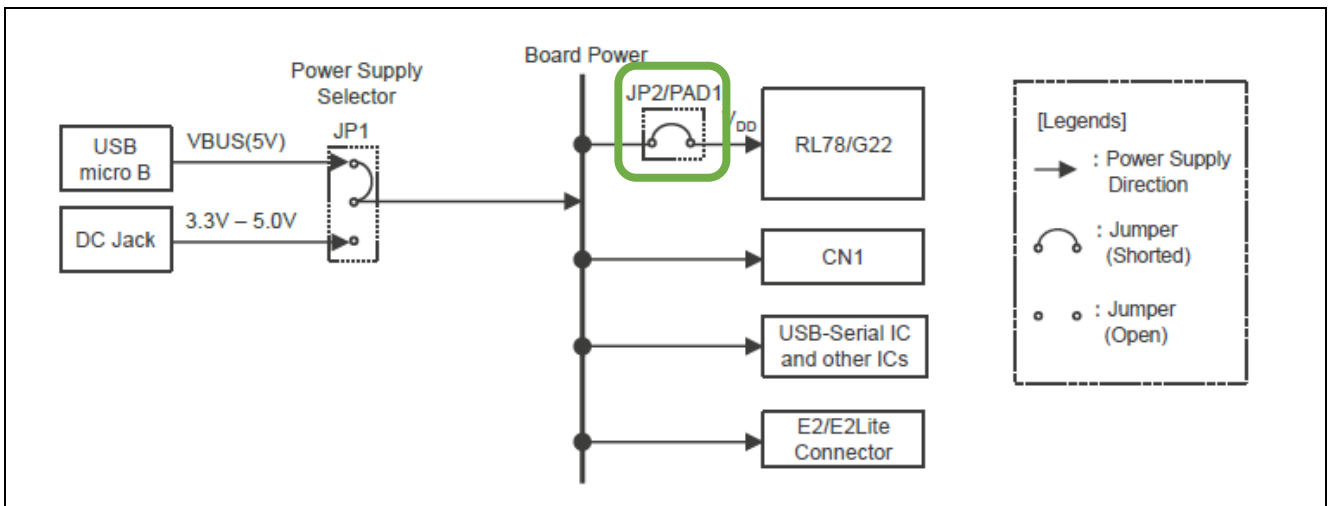

Figure 8-3 Power supply system diagram for the RL78/G22 capacitive touch evaluation system CPU board

## 8.4 RL78/G22 Capacitive Touch Evaluation System CPU Board

Figure 8-4 shows the pins of RL78/G22 Capacitive Touch Evaluation System CPU Board to be connected to the digital multimeter and the 16-pin and 32-pin wires of the Application Header (CN2). Table 8-2 shows the jumper settings on RL78/G22 Capacitive Touch Evaluation System CPU Board.

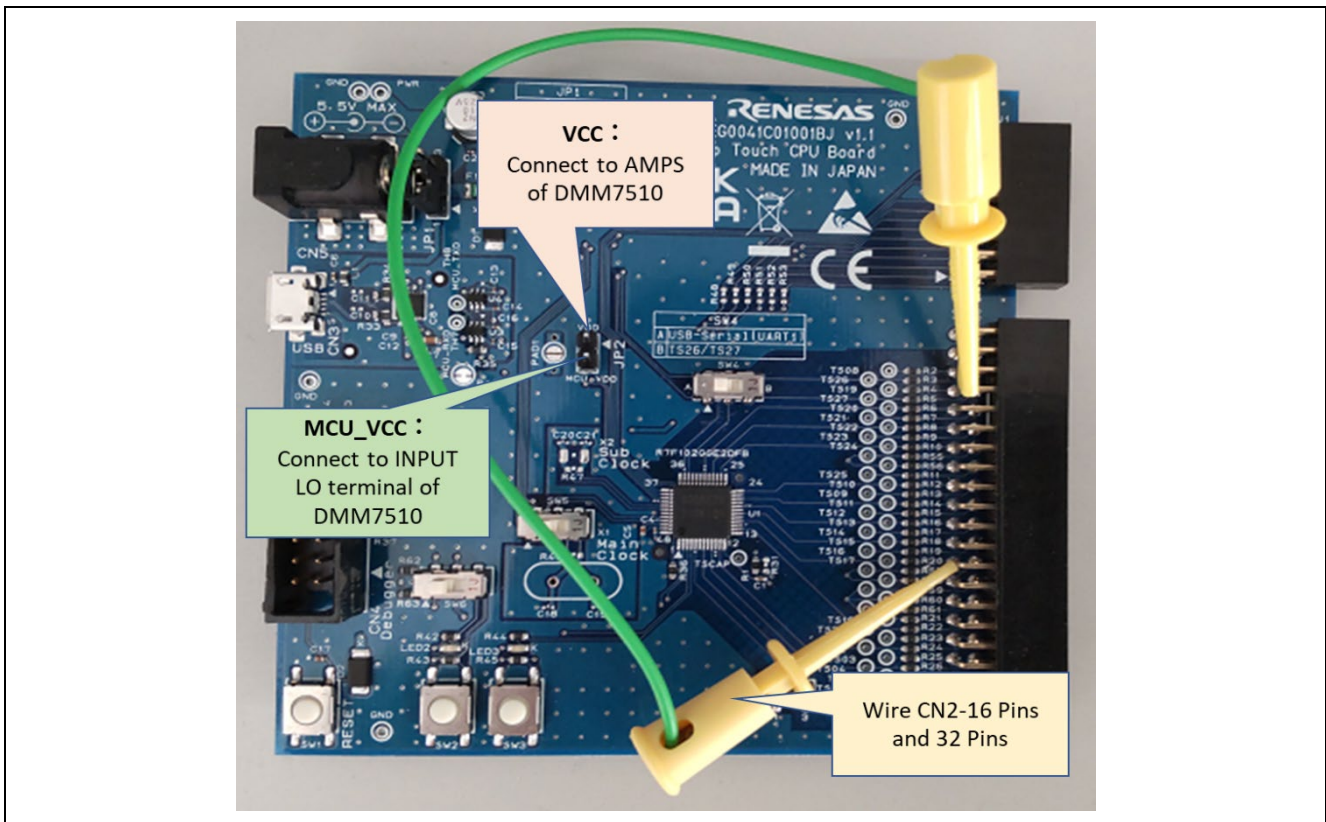

Figure 8-4 Pins of CPU board connected to the digital multimeter

Table 8-2 CPU board jumper settings

Position	Circuit group	Jumper setting	Use
JP1	VCC power	Shorted pin 2-3	Power supply from CN5
JP2	MCU_VCC_power	Open	Measure current consumption
SW4	USB-Serial Conversion/Application Header (CN2)	OFF	Using P00/TS26/TxD1, P01/TS27/RxD1 as a serial communication terminal
SW5	Clock Circuit/Application Header (CN1)	OFF	Use P121/X1, P122/X2 as GPIO (CN1)
SW6	Push-Switch LED/Application Headers (CN1)	OFF	Use P61, P62 as GPIO (CN1)
SW7	Capacitance touch	OFF	Using TS01 as Normal CTSU Pin

### 8.5 Settings of current measuring software

Figure 8-5 shows settings of KEITHLEY/KickStart software to measure current consumption.

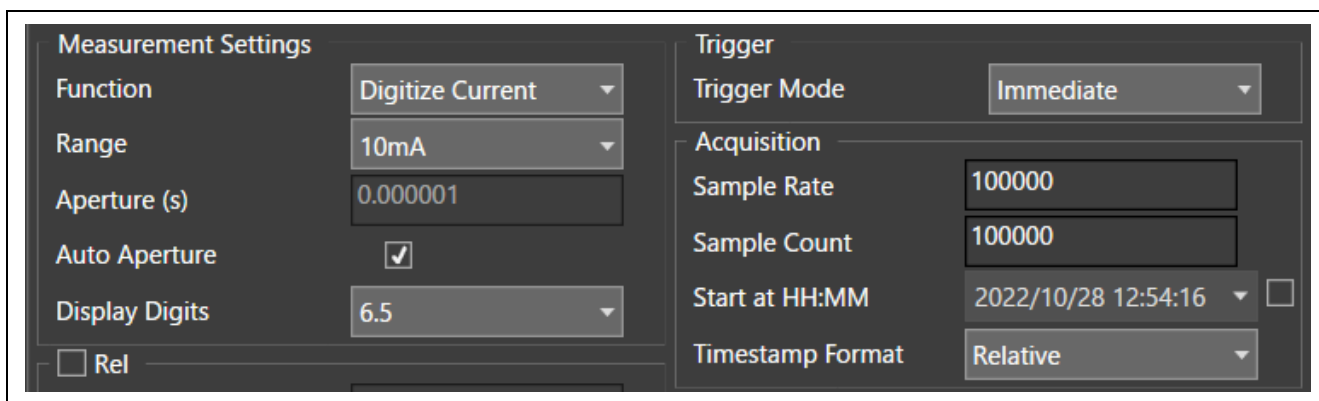

Figure 8-5 Settings of KEITHLEY/KickStart software

## 9. Current consumption measurement result

### 9.1 Current consumption waveform in intermittent operation

Figure 9-1 shows the Current consumption waveform in intermittent operation with touch measurement every 100 ms.

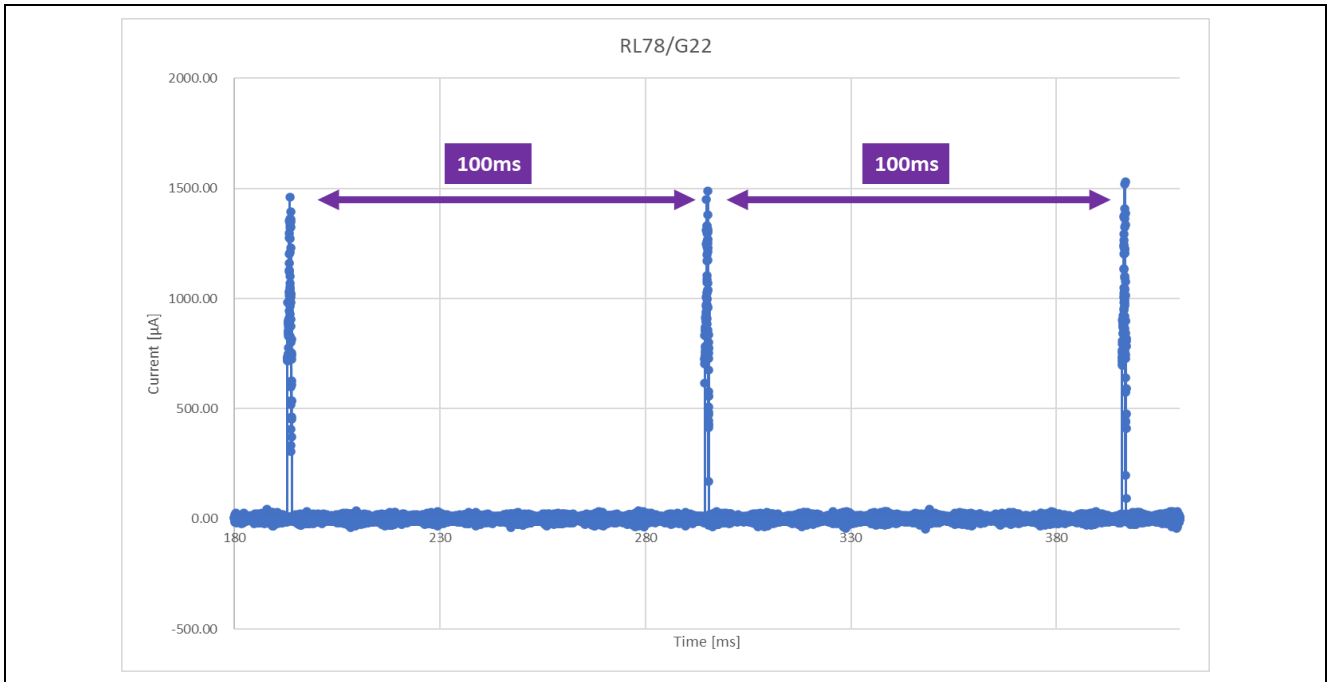

Figure 9-1 Current waveform in intermittent operation with touch measurement every 100 ms

### 9.2 Current consumption waveform during CPU state transition (Touch measurement using SMS/MEC)

Figure 9-2 shows the current consumption waveform when the CPU operation mode transitions to STOP mode and SNOOZE mode (touch measurement processing + touch on/off determination processing).

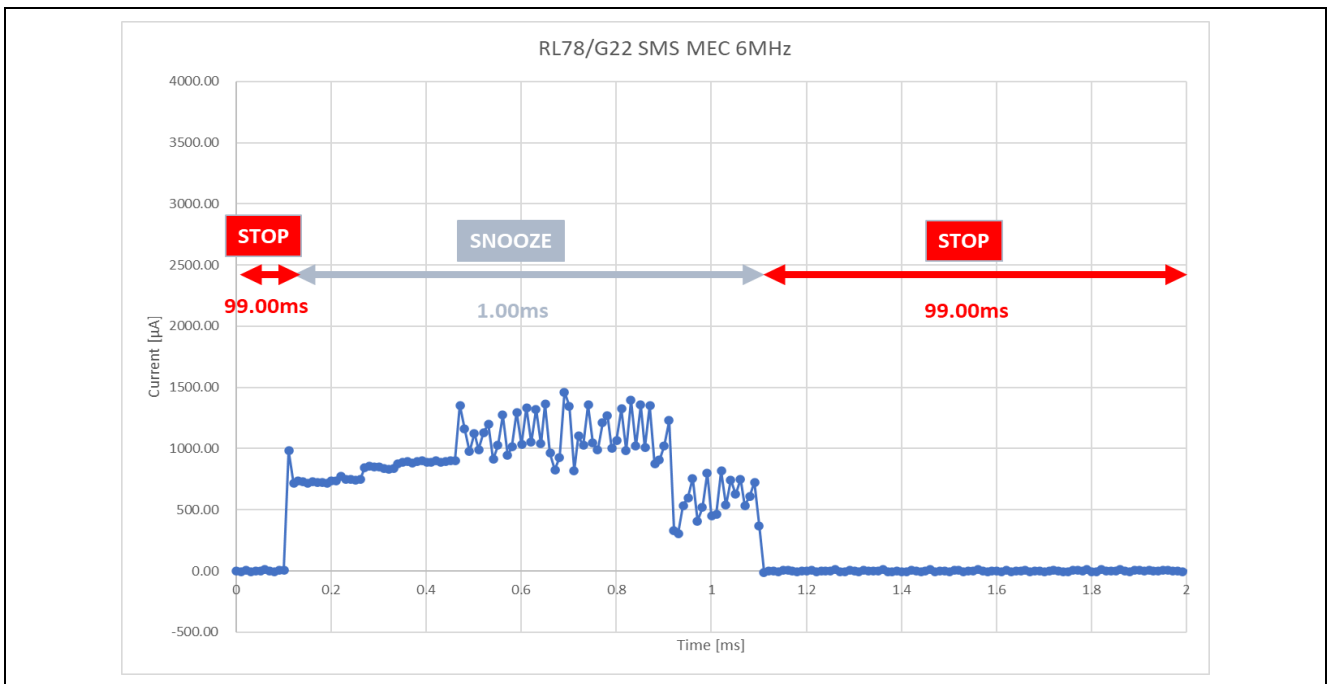
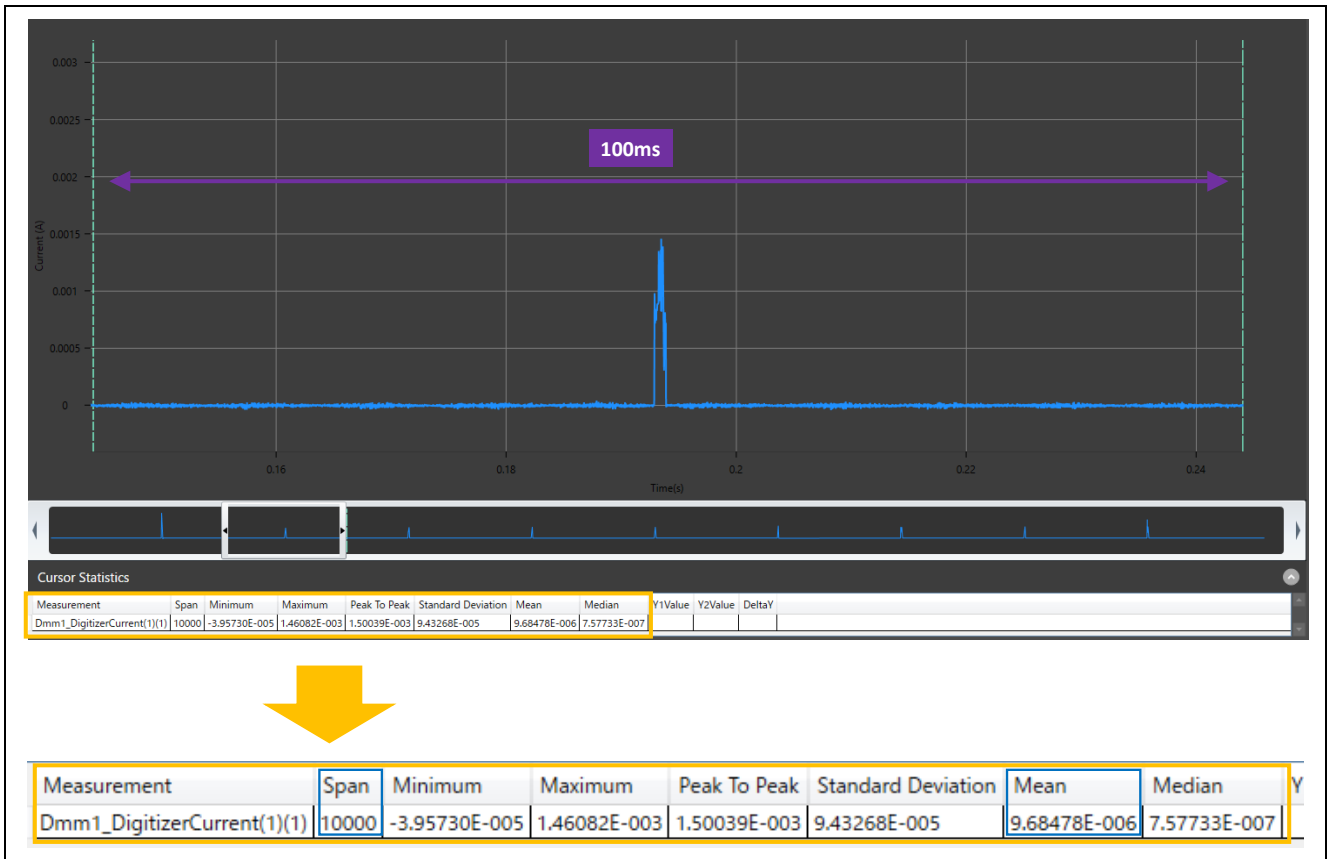

Figure 9-2 MEC Measurement of Current Consumption (Touch-Measurement Using SMS/MEC)

### 9.3 Current Consumption Calculation (Touch-Measurement Using SMS/MEC)

Figure 9-3 shows the average current consumption of 100 ms cycle by the KEITHLEY/KickStart software.



**Figure 9-3** Current Consumption (Touch-measurement using SMS/MEC)

Current consumption (touch measurement cycle of 100 ms) = **9.6848 μA**

## 10. Related Document

RL78/Gxx User's Manual: Hardware

- RL78/G22 User's Manual: Hardware (R01UH0978)

RL78 Family User's Manual: Software (R01US0015)

(The latest version can be downloaded from the Renesas Electronics website.)

Technical Update/Technical News

(The latest version can be downloaded from the Renesas Electronics website.)

User's Manual : Development Environments

(The latest version can be downloaded from the Renesas Electronics website.)

User's Manual : RL78/G22 Capacitive Touch Evaluation System (RTK0EG0042S01001BJ)

(The latest version can be downloaded from the Renesas Electronics website.)

Application Note RL78 Family Capacitive Touch Sensing Unit (CTS2L) Operation Explanation (R01AN5744)

Application Note RL78 Family

Using QE and SIS to Develop Capacitive Touch Applications (R01AN5512)

Application Note RL78 Family CTSU Module Software Integration System (R11AN0484)

Application Note RL78 Family TOUCH Module Software Integration System (R11AN0485)

Application Note Capacitive Sensor Microcontrollers CTSU Capacitive Touch Electrode Design Guide (R30AN0389)

(The latest version can be downloaded from the Renesas Electronics website.)

## Website and Support

Renesas Electronics Website

<http://www.renesas.com/>

Capacitive Sensing Unit related page

<https://www.renesas.com/solutions/touch-key>

<https://www.renesas.com/qe-capacitive-touch>

Inquiries

<http://www.renesas.com/contact/>



**Revision History**

Rev.	Date	Description	
		Page	Summary
1.00	Mar.14.23	-	First edition issued
1.10	Jul.19.23	4	Table 3-1 Operation environment, updated
		5	Table 3-3 Option Byte Settings, added
		7	Figure 5-1 Components, updated
		10	Renamed "7.Current measurement software flow chart" to "7.Sample Project flow chart"
1.20	May.31.24	3	Added wheel measurement in normal mode Changed the number of electrodes for MEC function to twelve
		4	Table 3-1 Operation environment, updated
		6	Figure 4-1 Touch interface configuration and Figure 4-2 Method settings, updated
		7	Figure 5-1 Components, updated
		9	Figure 6-1 Operation image when measuring touch using SMS (When determining touch-off), updated

# General Precautions in the Handling of Microprocessing Unit and Microcontroller Unit Products

The following usage notes are applicable to all Microprocessing unit and Microcontroller unit products from Renesas. For detailed usage notes on the products covered by this document, refer to the relevant sections of the document as well as any technical updates that have been issued for the products.

## 1. Precaution against Electrostatic Discharge (ESD)

A strong electrical field, when exposed to a CMOS device, can cause destruction of the gate oxide and ultimately degrade the device operation. Steps must be taken to stop the generation of static electricity as much as possible, and quickly dissipate it when it occurs. Environmental control must be adequate. When it is dry, a humidifier should be used. This is recommended to avoid using insulators that can easily build up static electricity.

Semiconductor devices must be stored and transported in an anti-static container, static shielding bag or conductive material. All test and measurement tools including work benches and floors must be grounded. The operator must also be grounded using a wrist strap. Semiconductor devices must not be touched with bare hands. Similar precautions must be taken for printed circuit boards with mounted semiconductor devices.

## 2. Processing at power-on

The state of the product is undefined at the time when power is supplied. The states of internal circuits in the LSI are indeterminate and the states of register settings and pins are undefined at the time when power is supplied. In a finished product where the reset signal is applied to the external reset pin, the states of pins are not guaranteed from the time when power is supplied until the reset process is completed. In a similar way, the states of pins in a product that is reset by an on-chip power-on reset function are not guaranteed from the time when power is supplied until the power reaches the level at which resetting is specified.

## 3. Input of signal during power-off state

Do not input signals or an I/O pull-up power supply while the device is powered off. The current injection that results from input of such a signal or I/O pull-up power supply may cause malfunction and the abnormal current that passes in the device at this time may cause degradation of internal elements. Follow the guideline for input signal during power-off state as described in your product documentation.

## 4. Handling of unused pins

Handle unused pins in accordance with the directions given under handling of unused pins in the manual. The input pins of CMOS products are generally in the high-impedance state. In operation with an unused pin in the open-circuit state, extra electromagnetic noise is induced in the vicinity of the LSI, an associated shoot-through current flows internally, and malfunctions occur due to the false recognition of the pin state as an input signal become possible.

## 5. Clock signals

After applying a reset, only release the reset line after the operating clock signal becomes stable. When switching the clock signal during program execution, wait until the target clock signal is stabilized. When the clock signal is generated with an external resonator or from an external oscillator during a reset, ensure that the reset line is only released after full stabilization of the clock signal. Additionally, when switching to a clock signal produced with an external resonator or by an external oscillator while program execution is in progress, wait until the target clock signal is stable.

## 6. Voltage application waveform at input pin

Waveform distortion due to input noise or a reflected wave may cause malfunction. If the input of the CMOS device stays in the area between  $V_{IL}$  (Max.) and  $V_{IH}$  (Min.) due to noise, for example, the device may malfunction. Take care to prevent chattering noise from entering the device when the input level is fixed, and also in the transition period when the input level passes through the area between  $V_{IL}$  (Max.) and  $V_{IH}$  (Min.).

## 7. Prohibition of access to reserved addresses

Access to reserved addresses is prohibited. The reserved addresses are provided for possible future expansion of functions. Do not access these addresses as the correct operation of the LSI is not guaranteed.

## 8. Differences between products

Before changing from one product to another, for example to a product with a different part number, confirm that the change will not lead to problems. The characteristics of a microprocessing unit or microcontroller unit products in the same group but having a different part number might differ in terms of internal memory capacity, layout pattern, and other factors, which can affect the ranges of electrical characteristics, such as characteristic values, operating margins, immunity to noise, and amount of radiated noise. When changing to a product with a different part number, implement a system-evaluation test for the given product.

## Notice

1. Descriptions of circuits, software and other related information in this document are provided only to illustrate the operation of semiconductor products and application examples. You are fully responsible for the incorporation or any other use of the circuits, software, and information in the design of your product or system. Renesas Electronics disclaims any and all liability for any losses and damages incurred by you or third parties arising from the use of these circuits, software, or information.
2. Renesas Electronics hereby expressly disclaims any warranties against and liability for infringement or any other claims involving patents, copyrights, or other intellectual property rights of third parties, by or arising from the use of Renesas Electronics products or technical information described in this document, including but not limited to, the product data, drawings, charts, programs, algorithms, and application examples.
3. No license, express, implied or otherwise, is granted hereby under any patents, copyrights or other intellectual property rights of Renesas Electronics or others.
4. You shall be responsible for determining what licenses are required from any third parties, and obtaining such licenses for the lawful import, export, manufacture, sales, utilization, distribution or other disposal of any products incorporating Renesas Electronics products, if required.
5. You shall not alter, modify, copy, or reverse engineer any Renesas Electronics product, whether in whole or in part. Renesas Electronics disclaims any and all liability for any losses or damages incurred by you or third parties arising from such alteration, modification, copying or reverse engineering.
6. Renesas Electronics products are classified according to the following two quality grades: "Standard" and "High Quality". The intended applications for each Renesas Electronics product depends on the product's quality grade, as indicated below.
  - "Standard": Computers; office equipment; communications equipment; test and measurement equipment; audio and visual equipment; home electronic appliances; machine tools; personal electronic equipment; industrial robots; etc.
  - "High Quality": Transportation equipment (automobiles, trains, ships, etc.); traffic control (traffic lights); large-scale communication equipment; key financial terminal systems; safety control equipment; etc.Unless expressly designated as a high reliability product or a product for harsh environments in a Renesas Electronics data sheet or other Renesas Electronics document, Renesas Electronics products are not intended or authorized for use in products or systems that may pose a direct threat to human life or bodily injury (artificial life support devices or systems; surgical implantations; etc.), or may cause serious property damage (space system; undersea repeaters; nuclear power control systems; aircraft control systems; key plant systems; military equipment; etc.). Renesas Electronics disclaims any and all liability for any damages or losses incurred by you or any third parties arising from the use of any Renesas Electronics product that is inconsistent with any Renesas Electronics data sheet, user's manual or other Renesas Electronics document.
7. No semiconductor product is absolutely secure. Notwithstanding any security measures or features that may be implemented in Renesas Electronics hardware or software products, Renesas Electronics shall have absolutely no liability arising out of any vulnerability or security breach, including but not limited to any unauthorized access to or use of a Renesas Electronics product or a system that uses a Renesas Electronics product. RENESAS ELECTRONICS DOES NOT WARRANT OR GUARANTEE THAT RENESAS ELECTRONICS PRODUCTS, OR ANY SYSTEMS CREATED USING RENESAS ELECTRONICS PRODUCTS WILL BE INVULNERABLE OR FREE FROM CORRUPTION, ATTACK, VIRUSES, INTERFERENCE, HACKING, DATA LOSS OR THEFT, OR OTHER SECURITY INTRUSION ("Vulnerability Issues"). RENESAS ELECTRONICS DISCLAIMS ANY AND ALL RESPONSIBILITY OR LIABILITY ARISING FROM OR RELATED TO ANY VULNERABILITY ISSUES. FURTHERMORE, TO THE EXTENT PERMITTED BY APPLICABLE LAW, RENESAS ELECTRONICS DISCLAIMS ANY AND ALL WARRANTIES, EXPRESS OR IMPLIED, WITH RESPECT TO THIS DOCUMENT AND ANY RELATED OR ACCOMPANYING SOFTWARE OR HARDWARE, INCLUDING BUT NOT LIMITED TO THE IMPLIED WARRANTIES OF MERCHANTABILITY, OR FITNESS FOR A PARTICULAR PURPOSE.
8. When using Renesas Electronics products, refer to the latest product information (data sheets, user's manuals, application notes, "General Notes for Handling and Using Semiconductor Devices" in the reliability handbook, etc.), and ensure that usage conditions are within the ranges specified by Renesas Electronics with respect to maximum ratings, operating power supply voltage range, heat dissipation characteristics, installation, etc. Renesas Electronics disclaims any and all liability for any malfunctions, failure or accident arising out of the use of Renesas Electronics products outside of such specified ranges.
9. Although Renesas Electronics endeavors to improve the quality and reliability of Renesas Electronics products, semiconductor products have specific characteristics, such as the occurrence of failure at a certain rate and malfunctions under certain use conditions. Unless designated as a high reliability product or a product for harsh environments in a Renesas Electronics data sheet or other Renesas Electronics document, Renesas Electronics products are not subject to radiation resistance design. You are responsible for implementing safety measures to guard against the possibility of bodily injury, injury or damage caused by fire, and/or danger to the public in the event of a failure or malfunction of Renesas Electronics products, such as safety design for hardware and software, including but not limited to redundancy, fire control and malfunction prevention, appropriate treatment for aging degradation or any other appropriate measures. Because the evaluation of microcomputer software alone is very difficult and impractical, you are responsible for evaluating the safety of the final products or systems manufactured by you.
10. Please contact a Renesas Electronics sales office for details as to environmental matters such as the environmental compatibility of each Renesas Electronics product. You are responsible for carefully and sufficiently investigating applicable laws and regulations that regulate the inclusion or use of controlled substances, including without limitation, the EU RoHS Directive, and using Renesas Electronics products in compliance with all these applicable laws and regulations. Renesas Electronics disclaims any and all liability for damages or losses occurring as a result of your noncompliance with applicable laws and regulations.
11. Renesas Electronics products and technologies shall not be used for or incorporated into any products or systems whose manufacture, use, or sale is prohibited under any applicable domestic or foreign laws or regulations. You shall comply with any applicable export control laws and regulations promulgated and administered by the governments of any countries asserting jurisdiction over the parties or transactions.
12. It is the responsibility of the buyer or distributor of Renesas Electronics products, or any other party who distributes, disposes of, or otherwise sells or transfers the product to a third party, to notify such third party in advance of the contents and conditions set forth in this document.
13. This document shall not be reprinted, reproduced or duplicated in any form, in whole or in part, without prior written consent of Renesas Electronics.
14. Please contact a Renesas Electronics sales office if you have any questions regarding the information contained in this document or Renesas Electronics products.

(Note1) "Renesas Electronics" as used in this document means Renesas Electronics Corporation and also includes its directly or indirectly controlled subsidiaries.

(Note2) "Renesas Electronics product(s)" means any product developed or manufactured by or for Renesas Electronics.

(Rev.5.0-1 October 2020)

## Corporate Headquarters

TOYOSU FORESIA, 3-2-24 Toyosu,  
Koto-ku, Tokyo 135-0061, Japan  
[www.renesas.com](http://www.renesas.com)

## Trademarks

Renesas and the Renesas logo are trademarks of Renesas Electronics Corporation. All trademarks and registered trademarks are the property of their respective owners.

## Contact information

For further information on a product, technology, the most up-to-date version of a document, or your nearest sales office, please visit:  
[www.renesas.com/contact/](http://www.renesas.com/contact/)