

## RX630 Group

R01AN1063EJ0100

Rev.1.00

## Clock Synchronous SCIC Communication Using the DMACA

---

Apr. 05, 2013

### Abstract

This application note describes a method for clock synchronous serial communication using the RX630's DMA controller (DMAC) and serial communication interface (SCI).

### Products

- RX630 Group, 177- and 176-pin versions, ROM capacity: 768 KB to 2 MB
- RX630 Group, 145- and 144-pin versions, ROM capacity: 768 KB to 2 MB
- RX630 Group, 100-pin version, ROM capacity: 384 KB to 2 MB
- RX630 Group, 80-pin version, ROM capacity: 384 KB or 512 KB

When using this application note with other Renesas MCUs, careful evaluation is recommended after making modifications to comply with the alternate MCU.

## Contents

1. Specifications .....	3
2. Operation Confirmation Conditions .....	4
3. Reference Application Note.....	4
4. Hardware .....	5
4.1 Hardware Configuration .....	5
4.2 Pins Used.....	5
5. Software .....	6
5.1 Operational Overview .....	7
5.1.1 Transmit Operation .....	7
5.1.2 Reception Operation.....	9
5.2 File Composition .....	11
5.3 Option-Setting Memory .....	11
5.4 Constants .....	12
5.5 Variable .....	12
5.6 Functions.....	13
5.7 Function Specifications .....	14
5.8 Flowcharts.....	17
5.8.1 Main Processing .....	17
5.8.2 Port Initialization .....	18
5.8.3 Peripheral Function Initialization.....	19
5.8.4 SCI9 Initialization .....	20
5.8.5 DMAC0 Initialization .....	21
5.8.6 DMAC1 Initialization .....	22
5.8.7 SCI9 Transmission and Reception Start .....	23
5.8.8 DMAC0 Transfer Complete Interrupt Handler .....	24
5.8.9 DMAC1 Transfer Complete Interrupt Handler .....	24
5.8.10 SCI9 Transmission Complete Interrupt Handler .....	25
5.8.11 Group 12 Interrupt Handler (SCI9 Reception Error Interrupt) .....	25
6. Sample Code.....	26
7. Reference Documents.....	26

### 1. Specifications

This sample program performs clock synchronous serial transmission and reception using the SCI module.

The transmit data is stored in advance in a RAM transmit data storage area and is transferred using a DMAC. The receive data is transferred to the RAM receive data storage area using a DMAC.

Serial communication is started when a falling edge is detected on the interrupt request pin (IRQ2).

- Transfer rate: 38,400 bps
- Communication format: 8 bits, LSB first
- Clock input/output: Clock output (master)
- Transmission/reception operation: Transmission and reception can be performed at the same time.

Table 1.1 lists the peripheral function used and their applications and figure 1.1 shows the block diagram.

**Table 1.1 Peripheral Functions and Their Applications**

Peripheral Function	Application
SCIc channel 9 (SCI9)	Clock synchronous serial transmission and reception
DMACA channel 0 (DMAC0)	Transfer of SCI receive data to RAM
DMACA channel 1 (DMAC1)	Transfer of RAM transmit data to the SCI module
IRQ2	Start trigger for serial transmission or reception

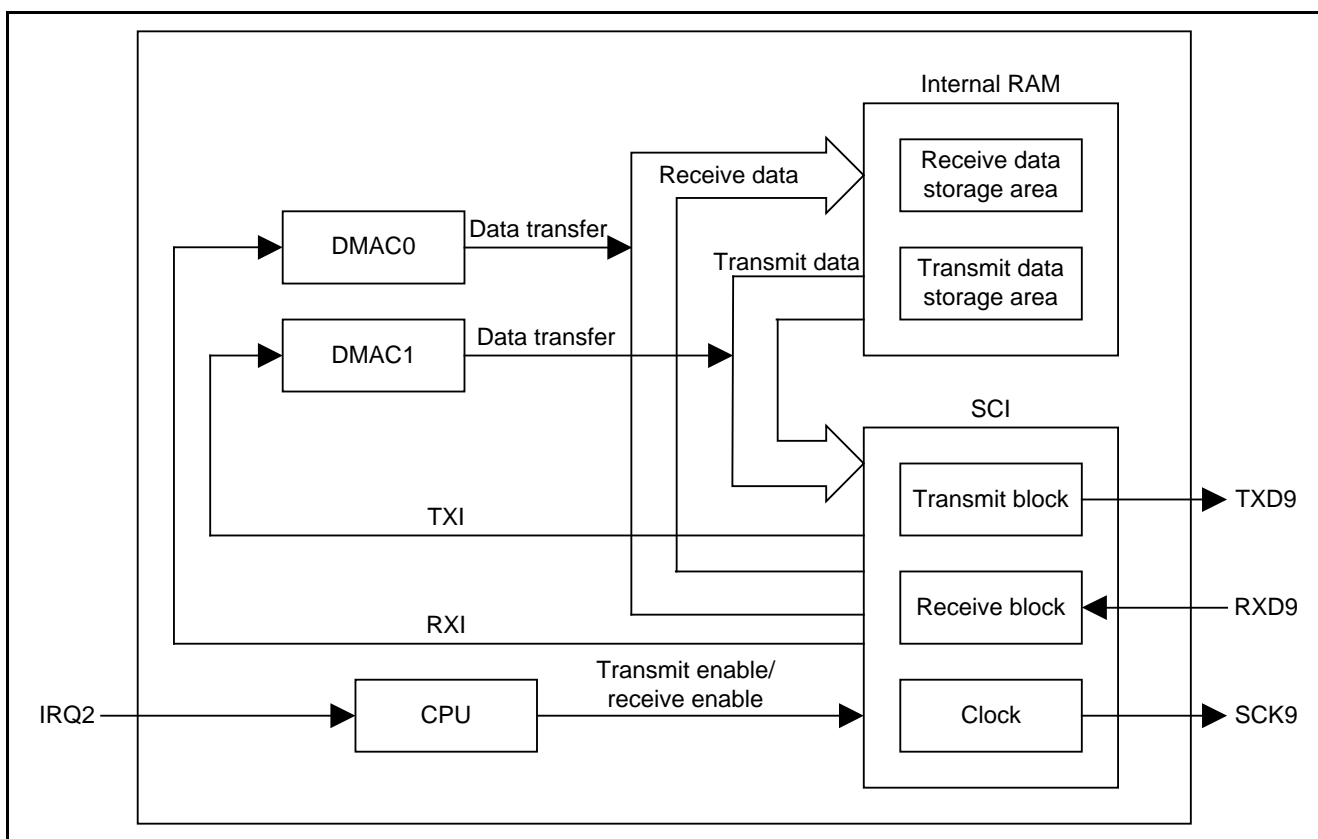

**Figure 1.1 Block Diagram**

## 2. Operation Confirmation Conditions

The sample code accompanying this application note has been run and confirmed under the conditions below.

**Table 2.1 Operation Confirmation Conditions**

Item	Description
Microcontroller used	R5F56308DDFP (RX630 Group)
Operating frequency	Main clock: 12 MHz PLL: 192 MHz (Main clock divided by 1 and multiplied by 16) System clock (ICLK): 96 MHz (PLL divided by 2) Peripheral module clock B (PCLKB): 48 MHz (PLL divided by 4)
Operating voltage	3.3 V
Integrated development environment	Renesas Electronics Corporation High-performance Embedded Workshop Version 4.09.01
C compiler	Renesas Electronics Corporation C/C++ Compiler Package for RX Family V.1.02 Release 01 Compiler options -cpu=rx600 -output=obj="\$(CONFIGDIR)\\$(FILELEAF).obj" -debug -nologo (The integrated development environment default settings are used.)
iodefine.h version	Version 1.50
Endian order	Little-endian
Operating mode	Single-chip mode
Processor mode	Supervisor mode
Sample code version	Version 1.00
Board used	Renesas Starter Kit for RX630 (Product number: R0K505630S000BE)

## 3. Reference Application Note

For additional information associated with this document, refer to the following application note.

- RX630 Group Initial Setting Rev.1.00 (R01AN1004EJ0100\_RX630)

The initialization functions from the above application note are used by the sample code in this application note. The revision number shown is the one used when this application note was written.

If there is a more recent version, use the latest version. Check the Renesas Electronics Corporation web site to verify and download the latest version.

## 4. Hardware

### 4.1 Hardware Configuration

Figure 4.1 shows a connection example.

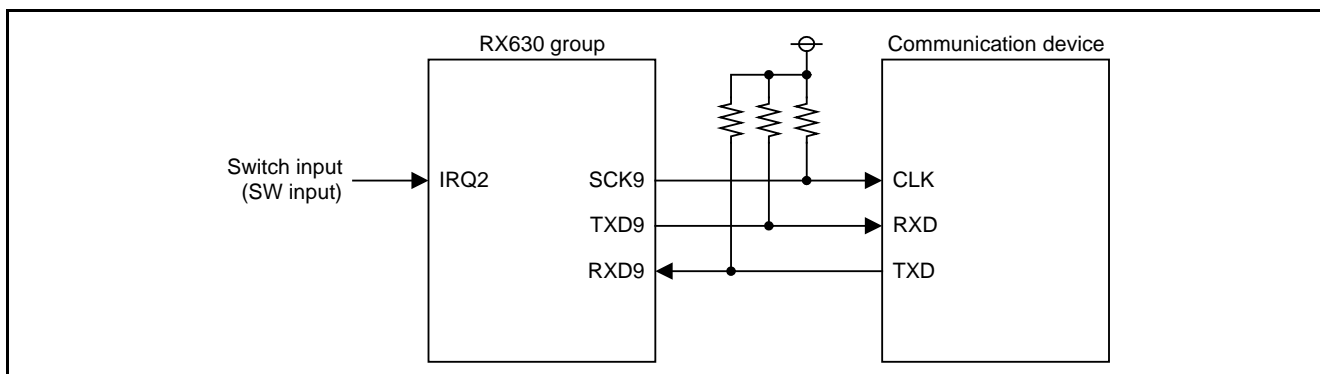

Figure 4.1 Connection Example

### 4.2 Pins Used

Table 4.1 lists the pins used and their functions.

Table 4.1 Pins Used and Their Functions

Pin Name	I/O	Function
P32/IRQ2	Input	Transmit/receive start switch input
PB5/SCK9	Output	SCI9 clock output
PB6/RXD9	Input	SCI9 receive data input
PB7/TXD9	Output	SCI9 transmit data output

## 5. Software

This sample code implements automatic SCI transmission and reception operations by using the DMAC. When the transmit/receive start switch is pressed a SCI transmit/receive operation is started.

If transmission is enabled and a TXI9 interrupt request occurs, it functions as a DMAC1 transfer request. DMAC1 transfers data in the transmit data storage area to the TDR register and that data is transmitted.

If a reception completes, an RXI9 interrupt request is generated and it functions as a DMAC0 transfer request. DMAC0 is used to transfer the receive data to the receive data storage area.

When the transfer of transmit data has been performed 256 times, a DMAC1 interrupt is generated. This disables the TXI9 interrupt and enables the TEI9 interrupt.

When the transfer of receive data has been performed 256 times, a DMAC0 interrupt is generated. This disables the RXI9 interrupt and sets the reception complete flag to 1. If the transmission complete flag is 1 at this time, SCI transmit/receive operations are disabled.

When 256 bytes of transmissions and 256 bytes of receptions have been completed, a TEI9 interrupt is generated. This disables the TEI9 interrupt and sets the transmission complete flag to 1. If the reception complete flag is 1 at this time, SCI transmit/receive operations are disabled.

The settings of the peripheral functions are listed below.

### SCI9

- Communication mode: Clock synchronous
- SCK9 pin: Internal clock output (master)
- Clock source: PCLKB/4
- Transfer rate: 38,400 bps (BRR register setting =  $(PCLKB/(8 \times 2 \times 38,400 \text{ bps})) - 1$ )
- Transmit operation: Enabled
- Receive operation: Enabled
- Data transfer direction: LSB first
- Interrupts used: Transmission complete interrupt (TEI9)  
Transmit data empty interrupt (TXI9)  
Receive data full interrupt (RXI9)  
Receive error interrupt (ERI9)

### DMAC0

- Start factor: RXI9 interrupt request  
The IR flag for the RXI9 interrupt is cleared to 0 at the start of transfer.
- Transfer source address: SCI9.RDR register
- Transfer source address update mode: Fixed address
- Transfer destination address: RAM (start address of the receive data storage area)
- Transfer destination address update mode: Increment
- Transfer mode: Normal mode
- Data transfer size: 8 bits
- Transfer count: 256 transfers
- Interrupts used: Transfer complete interrupt (DMAC0I)

**DMAC1**

- Start factor: TXI9 interrupt request  
The IR flag for the TXI9 interrupt is cleared to 0 at the start of transfer.
- Transfer source address: RAM (start address of the transmit data storage area)
- Transfer source address update mode: Increment
- Transfer destination address: SCI9.TDR register
- Transfer destination address update mode: Fixed address
- Transfer mode: Normal mode
- Data transfer size: 8 bits
- Transfer count: 256 transfers
- Interrupts used: Transfer complete interrupt (DMAC1I)

**IRQ2 input pin**

- Detection method: Falling edge detection
- Digital filter: Enabled (sampling clock: PCLKB/8)
- Interrupts used: None

**5.1 Operational Overview****5.1.1 Transmit Operation**

## (1) Initialization

After initialization, the sample code waits for a transmit/receive start switch input.

## (2) Transmit/receive start switch input detection

When a transmit/receive start switch input is detected, the IRQ2 interrupt IR flag is set to 0. After verifying that transmission and reception have completed by checking the transmission complete flag and the reception complete flag, the transmission complete flag is set to 0 (transmission in progress). The DMAC1 transfer source address and transfer count are set and DMA transfers are enabled.

The SCI9.SCR.TEIE, TIE, RIE, TE, and RE bits are all set to 1 at the same time to enable transmission and reception operations. The TXI9 interrupt IR flag is set to 1 by the SCI9.TCR.TIE and TE bits being set to 1 at the same time.

## (3) Data transfer start

When the TXI9 interrupt is enabled, DMAC1 is started and the TXI9 interrupt IR flag is set to 0. The first byte of transmit data is transferred from the RAM transmit data storage area to the SCI9.TSR register.

## (4) Data transmission start

Data is transferred from the SCI9.TDR register to the SCI9.TSR register, the TXI9 interrupt IR flag is set to 1, and the first byte of transmit data is output from the TXD9 pin. DMAC1 is started by the TXI9 interrupt request and the second byte of transmit data is transferred.

## (5) DMAC1I interrupt

When the 256th data transfer completes, a DMAC1I interrupt request is generated. The TXI9 interrupt is disabled and the TEI9 interrupt is enabled during DMAC1I interrupt handling.

## (6) TEI9 interrupt

Since the SCI9.TDR register is not updated when the last bit of the 256th byte is transmitted, a TEI9 interrupt request is generated. During TEI9 interrupt handling, the TEI9 interrupt is disabled and the transmission complete flag is set to 1 (transmission complete). If the reception complete flag is 1 (reception complete), transmission and reception are disabled.

Execution is then repeated from step (2) above.

Figure 5.1 shows the timing chart for the transmission operation.

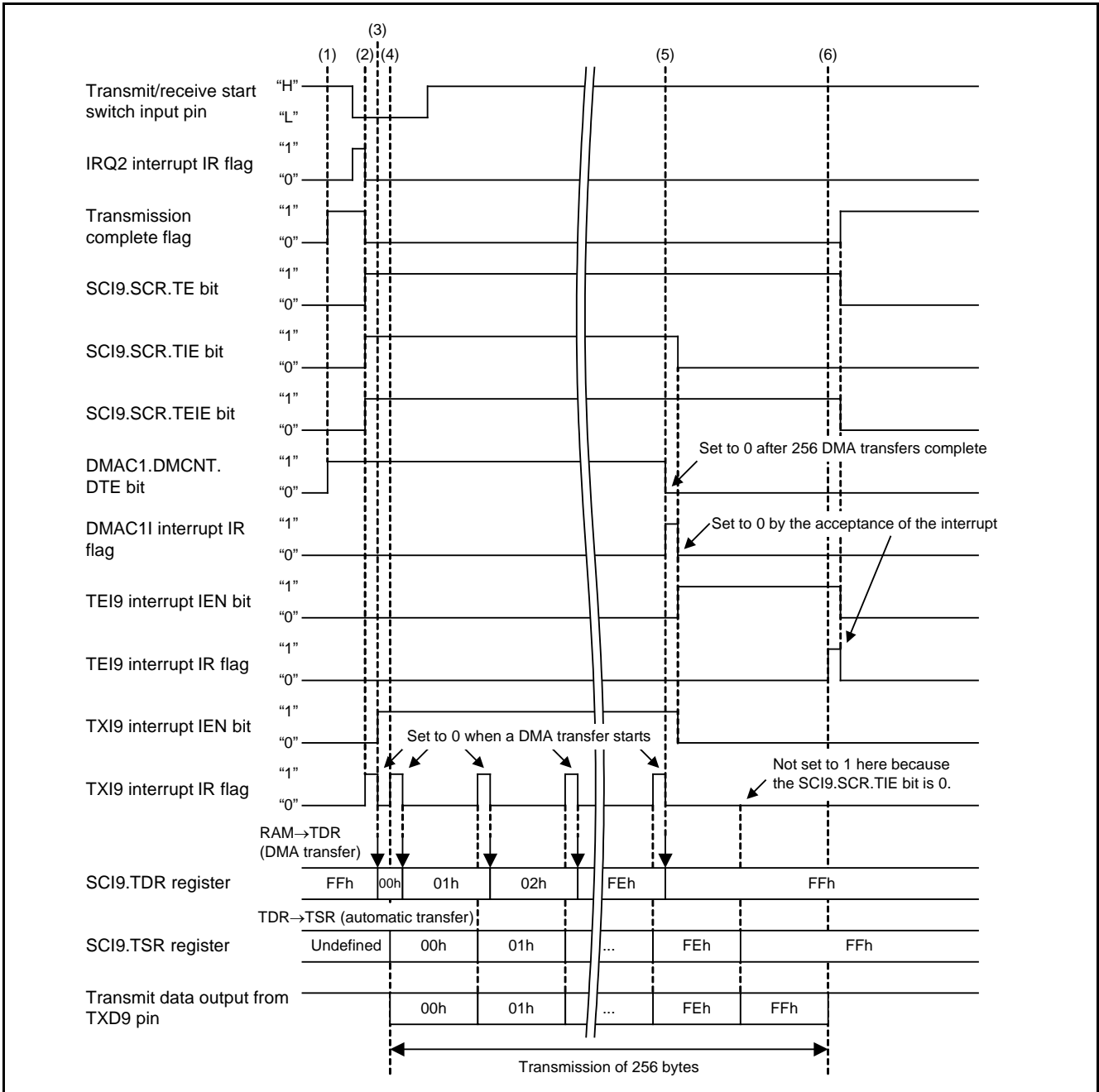

Figure 5.1 Transmission Operation Timing Chart



### 5.1.2 Reception Operation

(1) Initialization

After initialization, the sample code waits for a transmit/receive start switch input.

(2) Transmit/receive start switch input detection

When a transmit/receive start switch input is detected, the IRQ2 interrupt IR flag is set to 0. After verifying that transmission and reception have completed by checking the transmission complete flag and the reception complete flag, the reception complete flag is set to 0 (reception in progress). The DMAC0 transfer destination address and transfer count are set and DMA transfers are enabled.

The SCI9.SCR.TEIE, TIE, RIE, TE, and RE bits are all set to 1 at the same time to enable transmission and reception operations and the RXI9 interrupt.

(3) Data reception completion

When reception of the first byte of data completes, the data is transferred from the SCI9.RSR register to the SCI9.RDR register and the RXI9 interrupt IR flag is set to 1.

(4) Data transfer start

DMAC0 is started by the RXI9 interrupt request and the RXI9 interrupt IR flag is cleared to 0. The first byte of receive data is transferred from the SCI9.RDR register to the RAM receive data storage area.

(5) DMAC0I interrupt

When the 256th data transfer completes, a DMAC0I interrupt request is generated. During DMAC0I interrupt handling, the RXI9 interrupt is disabled and the reception complete flag is set to 1 (reception complete). If the transmission complete flag is 1 (transmission complete), transmission and reception are disabled. Execution is then repeated from step (2) above.

Figure 5.2 shows the timing chart for the transmission operation.

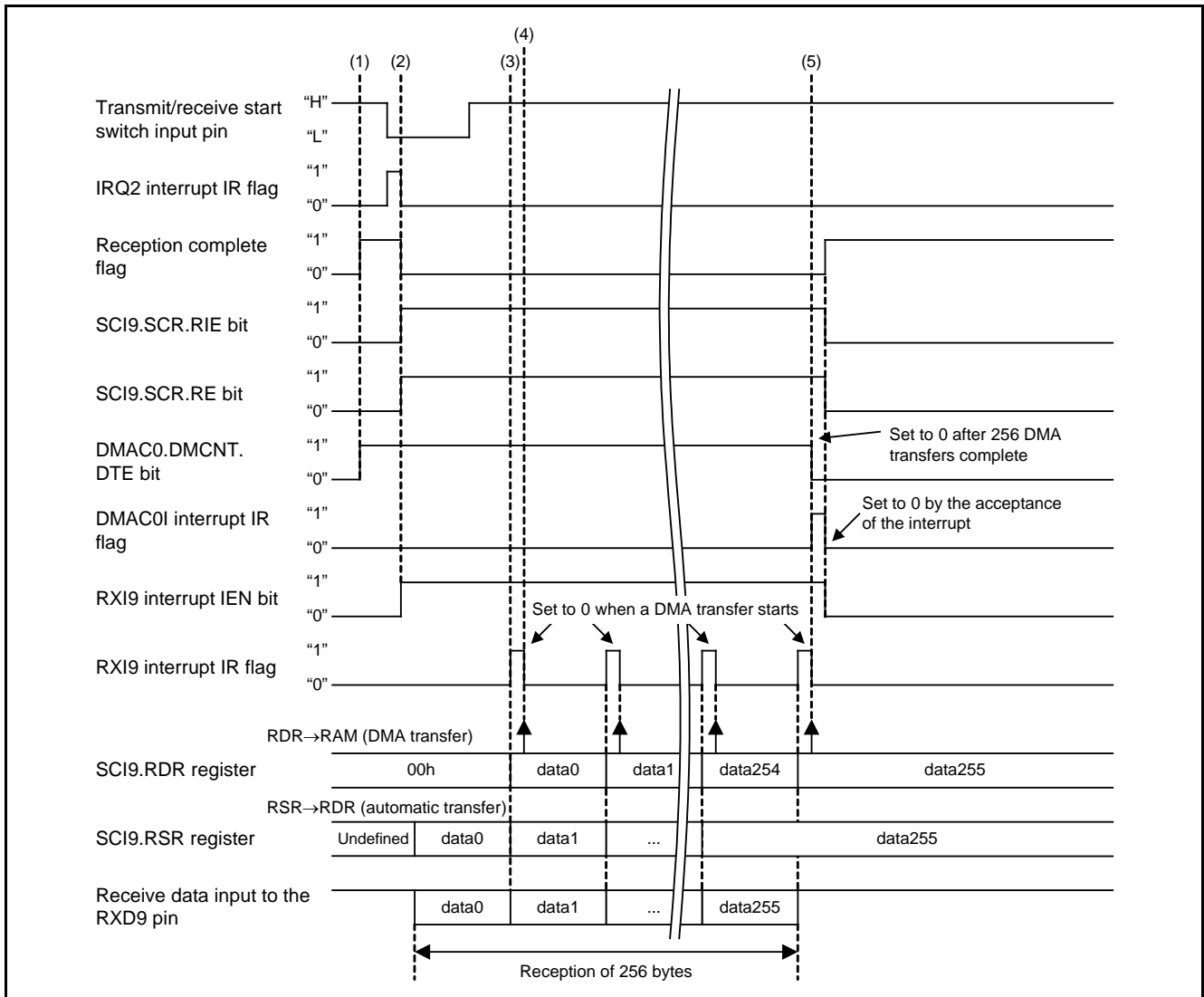

Figure 5.2 Reception Operation Timing Chart

### Notes on Embedding the Sample Code in the User System

When embedding the sample code from this application note in the actual system, note the following:

- When operating in slave mode, if the interrupts used in this application are forced to wait for extended periods due to, for example, the handling of other interrupts, this code may not operate correctly.

## 5.2 File Composition

Table 5.1 lists the files used in the sample code. Files generated by the integrated development environment are not included in this table.

**Table 5.1 Files Used in the Sample Code**

File Name	Outline	Remarks
main.c	Main processing	
r_init_stop_module.c	Stops peripheral modules that are operating after a reset	
r_init_stop_module.h	Header file for r_init_stop_module.c	
r_init_non_existent_port.c	Initialization for ports that do not exist	
r_init_non_existent_port.h	Header file for r_init_non_existent_port.c	
r_init_clock.c	Initialization for clock	
r_init_clock.h	Header file for r_init_clock.c	

## 5.3 Option-Setting Memory

Table 5.2 lists the option-setting memory configured in the sample code. When necessary, set a value suited to the user system.

**Table 5.2 Option-Setting Memory Configured in the Sample Code**

Symbol	Address	Setting Value	Contents
OFS0	FFFF FF8Fh to FFFF FF8Ch	FFFF FFFFh	Stops IWDT after a reset Stops WDT after a reset
OFS1	FFFF FF8Bh to FFFF FF88h	FFFF FFFFh	Disables voltage monitoring 0 resets after a reset Disables HOCO oscillation after a reset
MDES	FFFF FF83h to FFFF FF80h	FFFF FFFFh	Little-endian

## 5.4 Constants

Table 5.3 lists the constants used in the sample code.

**Table 5.3 Constants Used in the Sample Code**

Constant Name	Setting Value	Contents
MASTER	00h	Set value of the SCI9.SCR.CKE[1:0] bits: Internal clock (master)
SLAVE	02h	Set value of the SCI9.SCR.CKE[1:0] bits: External clock (slave)
SCI_CLK	MASTER	Set value of the SCI9.SCR.CKE[1:0] bits: Master mode selected
BUF_SIZE	256	Size of the transmission and reception data storage areas
DMAC_CNT	BUF_SIZE	DMAC transfer count
SW_ON	1	Switch input on state
SW_OFF	0	Switch input off state

## 5.5 Variable

Table 5.4 lists the global variables.

**Table 5.4 Global Variables**

Type	Variable Name	Contents	Function Used
unsigned char	rcv_end_flag	Reception complete flag 0: Reception in progress 1: Reception complete	main Excep_DMAC_DMACH0I Excep_SCI9_TEI9
unsigned char	trn_end_flag	Transmission complete flag 0: Transmission in progress 1: Transmission complete	main Excep_DMAC_DMACH0I Excep_SCI9_TEI9
unsigned char	rcvbuf[BUF_SIZE]	Receive data storage area	dmac0_init sci9_start
unsigned char	trnbuf[BUF_SIZE]	Transmit data storage area	main dmac1_init sci9_start

## 5.6 Functions

Table 5.5 lists the functions used in the sample code.

**Table 5.5 Functions Used in the Sample Code**

Function Name	Outline
main	Main processing
port_init	Port initialization
R_INIT_StopModule	Stop processing for active peripheral functions after a reset
R_INIT_NonExistentPort	Nonexistent port initialization
R_INIT_Clock	Clock initialization
peripheral_init	Peripheral function initialization
sci9_init	SCI9 initialization
dmac0_init	DMAC0 initialization
dmac1_init	DMAC1 initialization
sci9_start	Starts SCI9 transmission and reception
Excep_DMCA_DMCA0I	DMAC0 transfer complete interrupt handler
Excep_DMCA_DMCA1I	DMAC1 transfer complete interrupt handler
Excep_SCI9_TEI9	SCI9 transmission complete interrupt handler
Excep_ICU_GROUP12	Group 12 interrupt handler (SCI9 receive error interrupt)

## 5.7 Function Specifications

The following tables list the sample code function specifications.

main	
<b>Outline</b>	Main processing
<b>Header</b>	None
<b>Declaration</b>	void main(void)
<b>Description</b>	After initialization, this function starts SCI9 transmission and reception operations when a transmit/receive start switch input is detected.
<b>Arguments</b>	None
<b>Return Value</b>	None

port_init	
<b>Outline</b>	Port initialization
<b>Header</b>	None
<b>Declaration</b>	void port_init(void)
<b>Description</b>	Initializes the ports.
<b>Arguments</b>	None
<b>Return Value</b>	None

R_INIT_StopModule	
<b>Outline</b>	Stop processing for active peripheral functions after a reset
<b>Header</b>	r_init_stop_module.h
<b>Declaration</b>	void R_INIT_StopModule(void)
<b>Description</b>	Configures the setting to enter the module-stop state.
<b>Arguments</b>	None
<b>Return Value</b>	None
<b>Remarks</b>	Transition to the module-stop state is not performed in the sample code. Refer to the RX630 Group Initial Setting Rev. 1.00 application note for details of this function.

R_INIT_NonExistentPort	
<b>Outline</b>	Nonexistent port initialization
<b>Header</b>	r_init_non_existent_port.h
<b>Declaration</b>	void R_INIT_NonExistentPort(void)
<b>Description</b>	Initializes port direction registers for ports that does not exist in products with less than 176 pins.
<b>Arguments</b>	None
<b>Return Value</b>	None
<b>Remarks</b>	The number of pins in the sample code is set for the 100-pin package (PIN_SIZE=100). After this function is called, when writing in byte units to the PDR registers or PODR registers which have nonexistent ports, set the corresponding bits for nonexistent ports as follows: set the I/O select bits in the PDR registers to 1 and set the output data store bits in the PODR registers to 0. Refer to the RX630 Group Initial Setting Rev. 1.00 application note for details of this function.

---

R_INIT_Clock	
<b>Outline</b>	Clock initialization
<b>Header</b>	r_init_clock.h
<b>Declaration</b>	void R_INIT_Clock(void)
<b>Description</b>	Initializes the clock.
<b>Arguments</b>	None
<b>Return Value</b>	None
<b>Remarks</b>	The sample code selects processing which uses PLL as the system clock without using the sub-clock. Refer to the RX630 Group Initial Setting Rev. 1.00 application note for details of this function.

---

peripheral_init	
<b>Outline</b>	Peripheral function initialization
<b>Header</b>	None
<b>Declaration</b>	void peripheral_init(void)
<b>Description</b>	Initializes the peripheral functions used.
<b>Arguments</b>	None
<b>Return Value</b>	None

---

sci9_init	
<b>Outline</b>	SCI9 initialization
<b>Header</b>	None
<b>Declaration</b>	void sci9_init(void)
<b>Description</b>	Initializes SCI9.
<b>Arguments</b>	None
<b>Return Value</b>	None

---

dmac0_init	
<b>Outline</b>	DMAC0 initialization
<b>Header</b>	None
<b>Declaration</b>	void dmac0_init(void)
<b>Description</b>	Initializes DMAC0.
<b>Arguments</b>	None
<b>Return Value</b>	None

---

dmac1_init	
<b>Outline</b>	DMAC1 initialization
<b>Header</b>	None
<b>Declaration</b>	void dmac1_init(void)
<b>Description</b>	Initializes DMAC1.
<b>Arguments</b>	None
<b>Return Value</b>	None

---

---

sci9_start	
<b>Outline</b>	Starts SCI9 transmission and reception
<b>Header</b>	None
<b>Declaration</b>	void sci9_start(void)
<b>Description</b>	Starts the SCI9 transmission and reception operation.
<b>Arguments</b>	None
<b>Return Value</b>	None

---

Excep_DMAC_DMAC0I	
<b>Outline</b>	DMAC0 transfer complete interrupt handler
<b>Header</b>	None
<b>Declaration</b>	void Excep_DMAC_DMAC0I(void)
<b>Description</b>	Disables the RXI9 interrupt and sets the reception complete flag. If the transmission complete flag is 1, it disables SCI9 transmission and reception.
<b>Arguments</b>	None
<b>Return Value</b>	None

---

Excep_DMAC_DMAC1I	
<b>Outline</b>	DMAC1 transfer complete interrupt handler
<b>Header</b>	None
<b>Declaration</b>	void Excep_DMAC_DMAC1I(void)
<b>Description</b>	Disables the TXI9 interrupt and enables the TEI9 interrupt.
<b>Arguments</b>	None
<b>Return Value</b>	None

---

Excep_SCI9_TEI9	
<b>Outline</b>	SCI9 transmission complete interrupt handler
<b>Header</b>	None
<b>Declaration</b>	void Excep_SCI9_TEI9(void)
<b>Description</b>	Disables the TEI9 interrupt and sets the transmission complete flag. If the reception complete flag is 1, it disables SCI9 transmission and reception.
<b>Arguments</b>	None
<b>Return Value</b>	None

---

Excep_ICU_GROUP12	
<b>Outline</b>	Group 12 interrupt handler (SCI9 receive error interrupt)
<b>Header</b>	None
<b>Declaration</b>	void Excep_ICU_GROUP12 (void)
<b>Description</b>	Handles group 12 interrupts (SCI9 receive error interrupt).
<b>Arguments</b>	None
<b>Return Value</b>	None
<b>Remarks</b>	This sample code does not perform the SCI9 receive error handling; it simply executes an infinite loop. Add a program if required.

---



5.8 Flowcharts

5.8.1 Main Processing

Figure 5.3 shows the flowchart for the main processing.

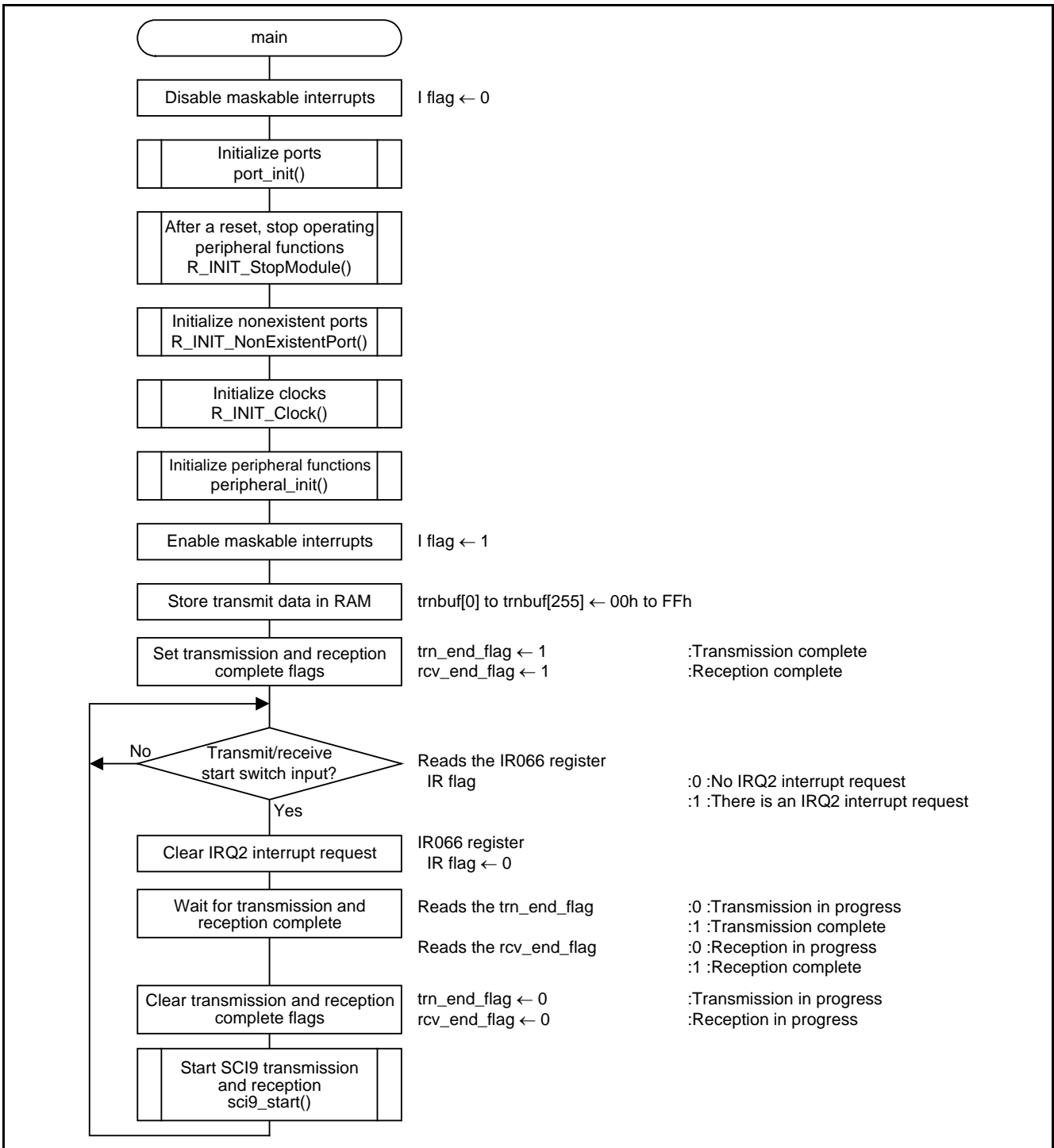

Figure 5.3 Main Processing

5.8.2 Port Initialization

Figure 5.4 shows the flowchart for the port initialization.

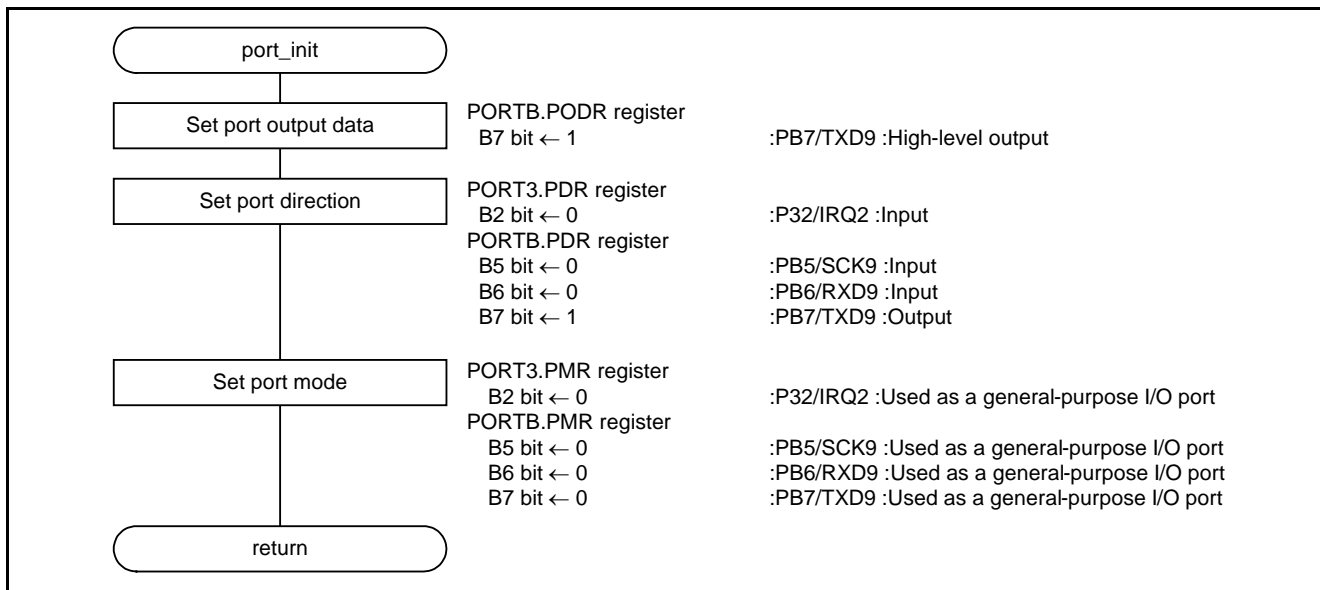

Figure 5.4 Port Initialization

5.8.3 Peripheral Function Initialization

Figure 5.5 shows the flowchart for the peripheral function initialization.

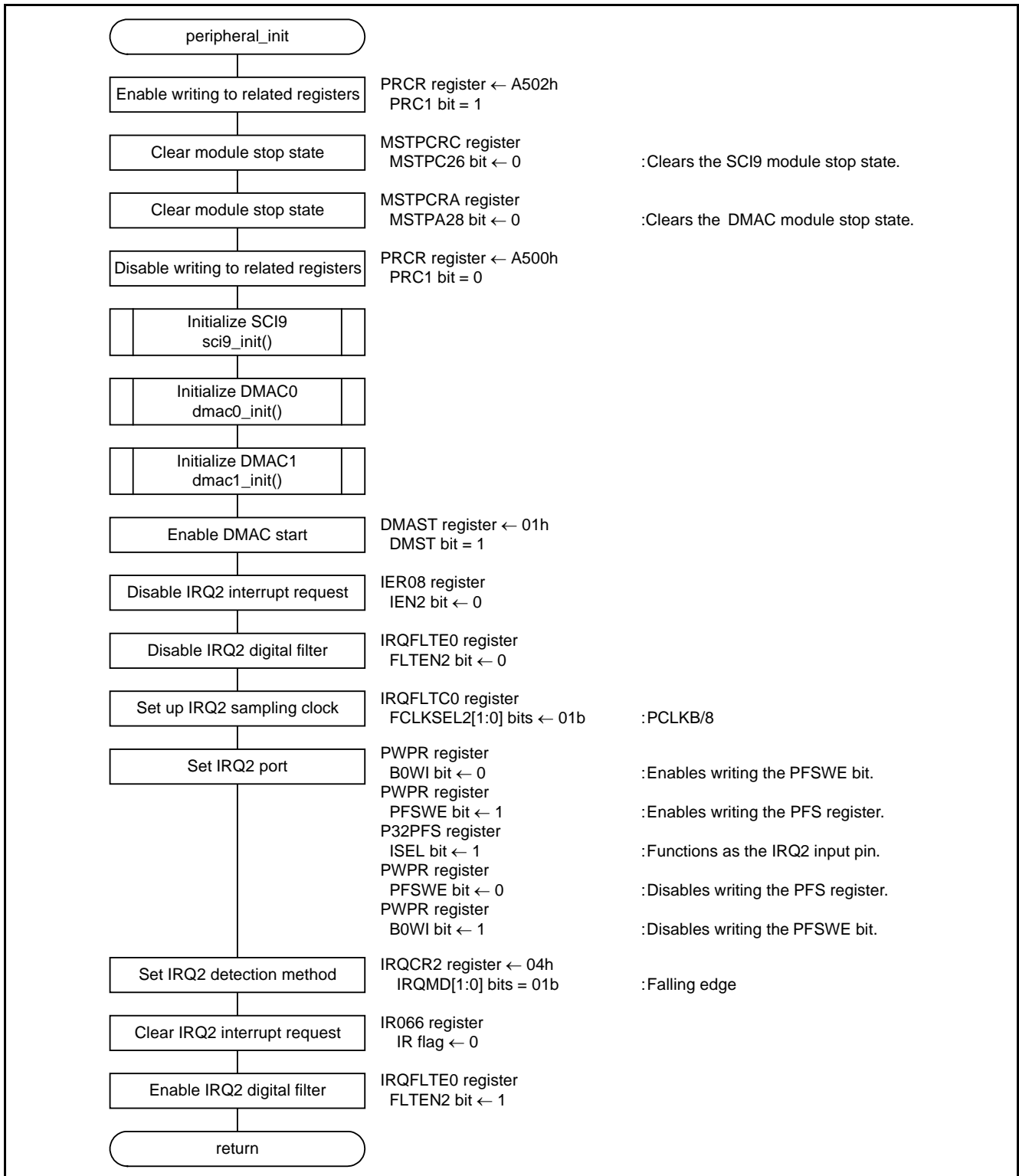

Figure 5.5 Peripheral Function Initialization

5.8.4 SCI9 Initialization

Figure 5.6 shows the flowchart for the SCI9 initialization.

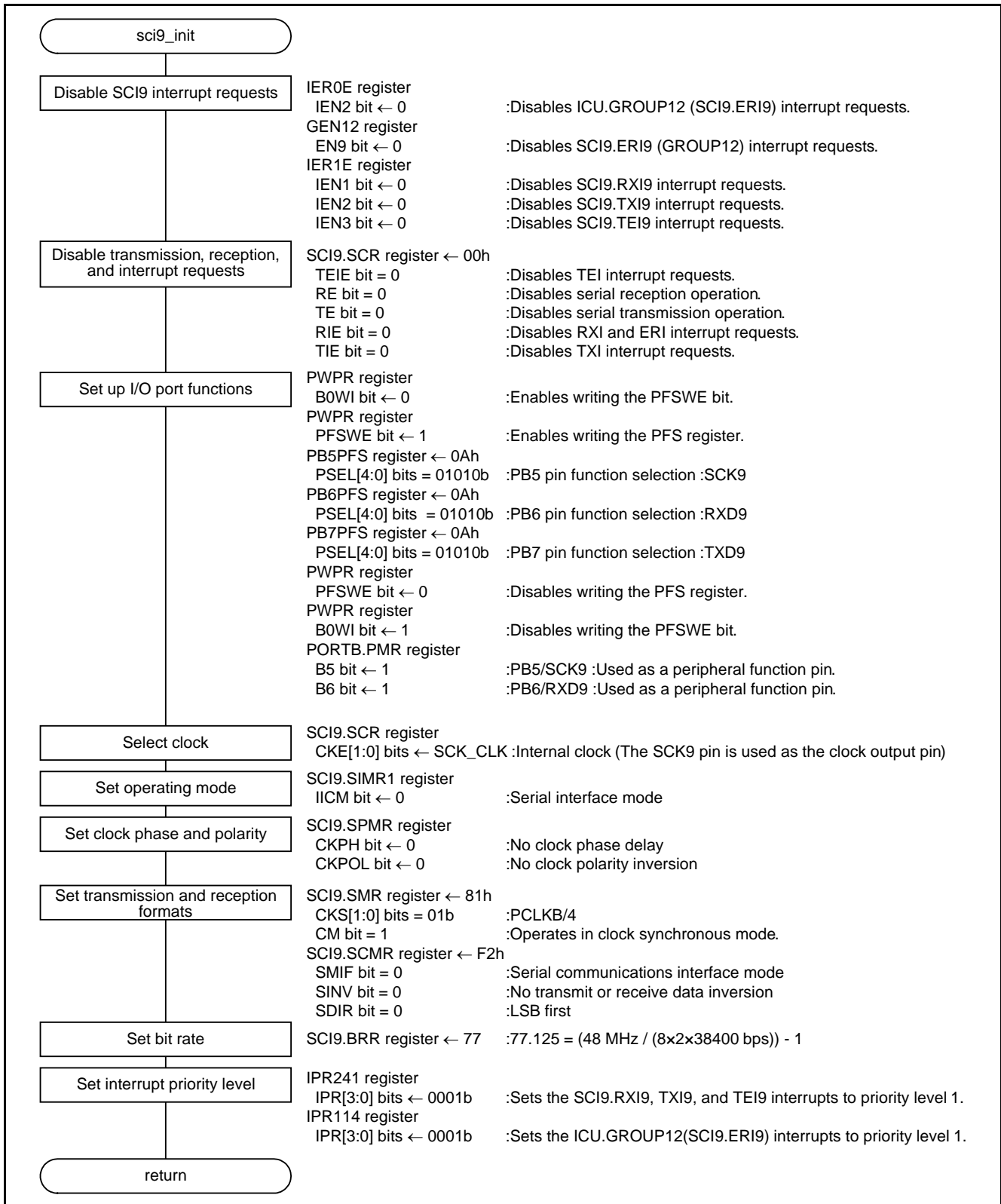

Figure 5.6 SCI9 Initialization

5.8.5 DMAC0 Initialization

Figure 5.7 shows the flowchart for the DMAC0 initialization.

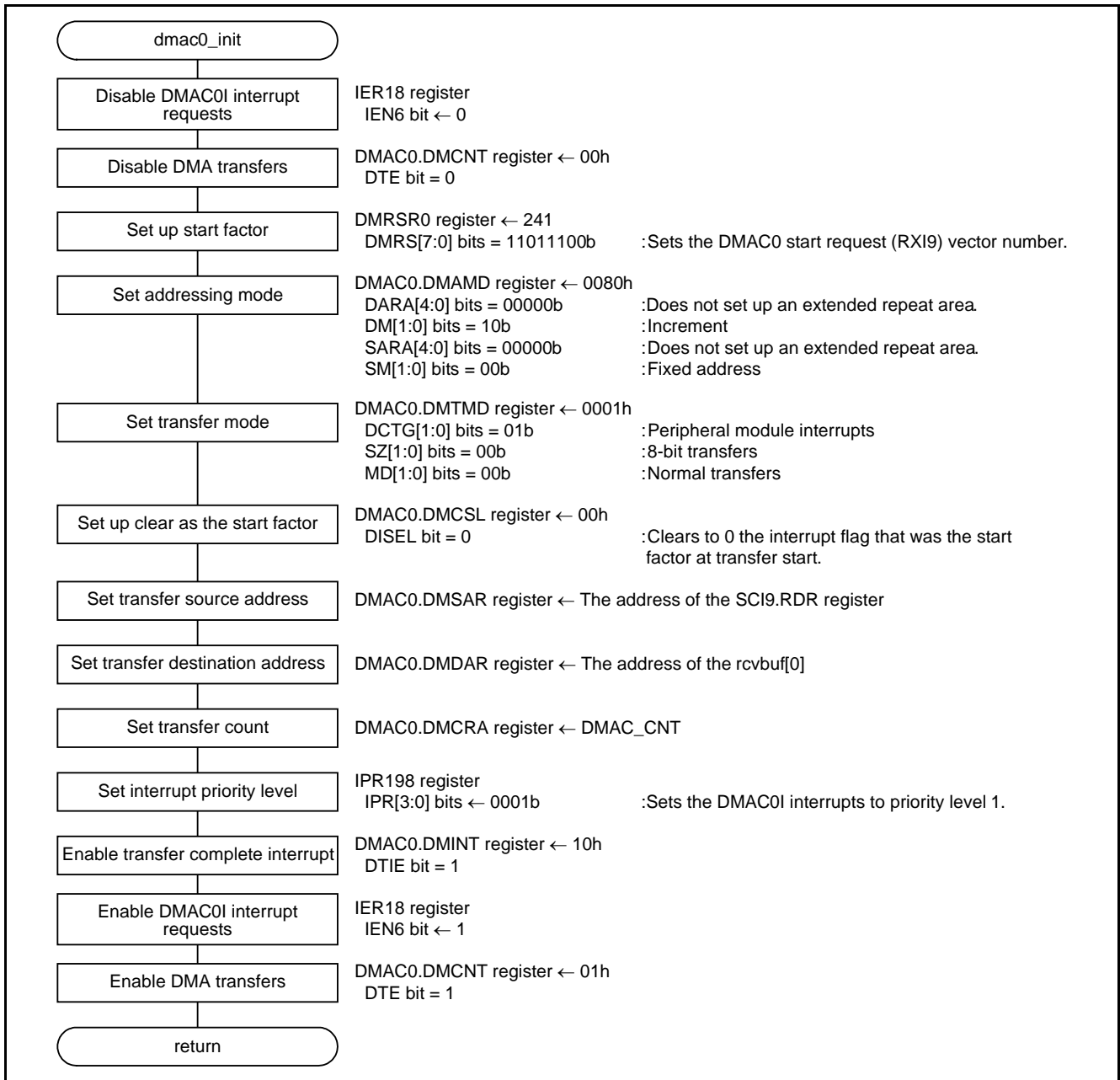

Figure 5.7 DMAC0 Initialization

5.8.6 DMAC1 Initialization

Figure 5.8 shows the flowchart for the DMAC1 initialization.

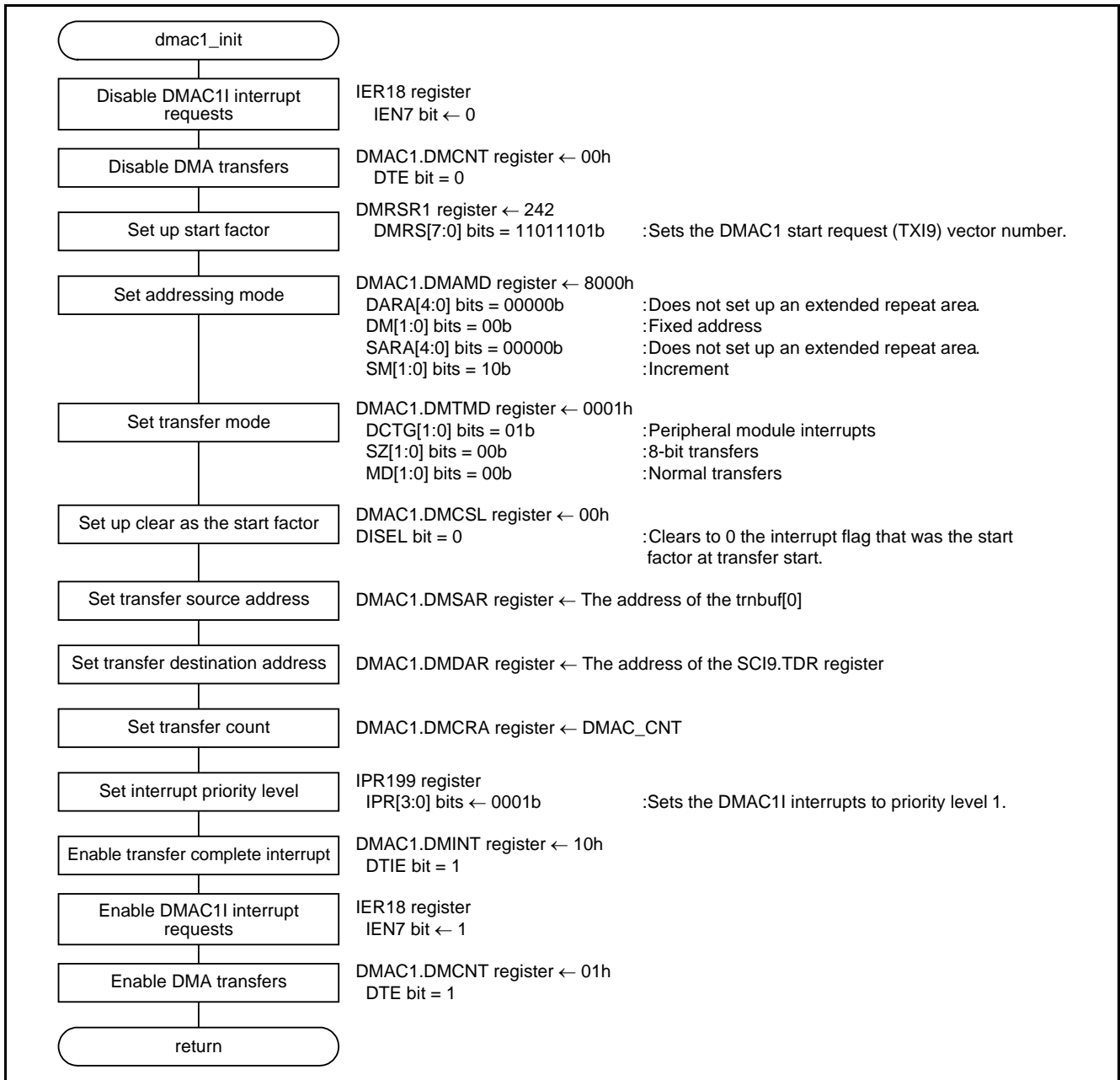

Figure 5.8 DMAC1 Initialization

5.8.7 SCI9 Transmission and Reception Start

Figure 5.9 shows the flowchart for the SCI9 transmission and reception start.

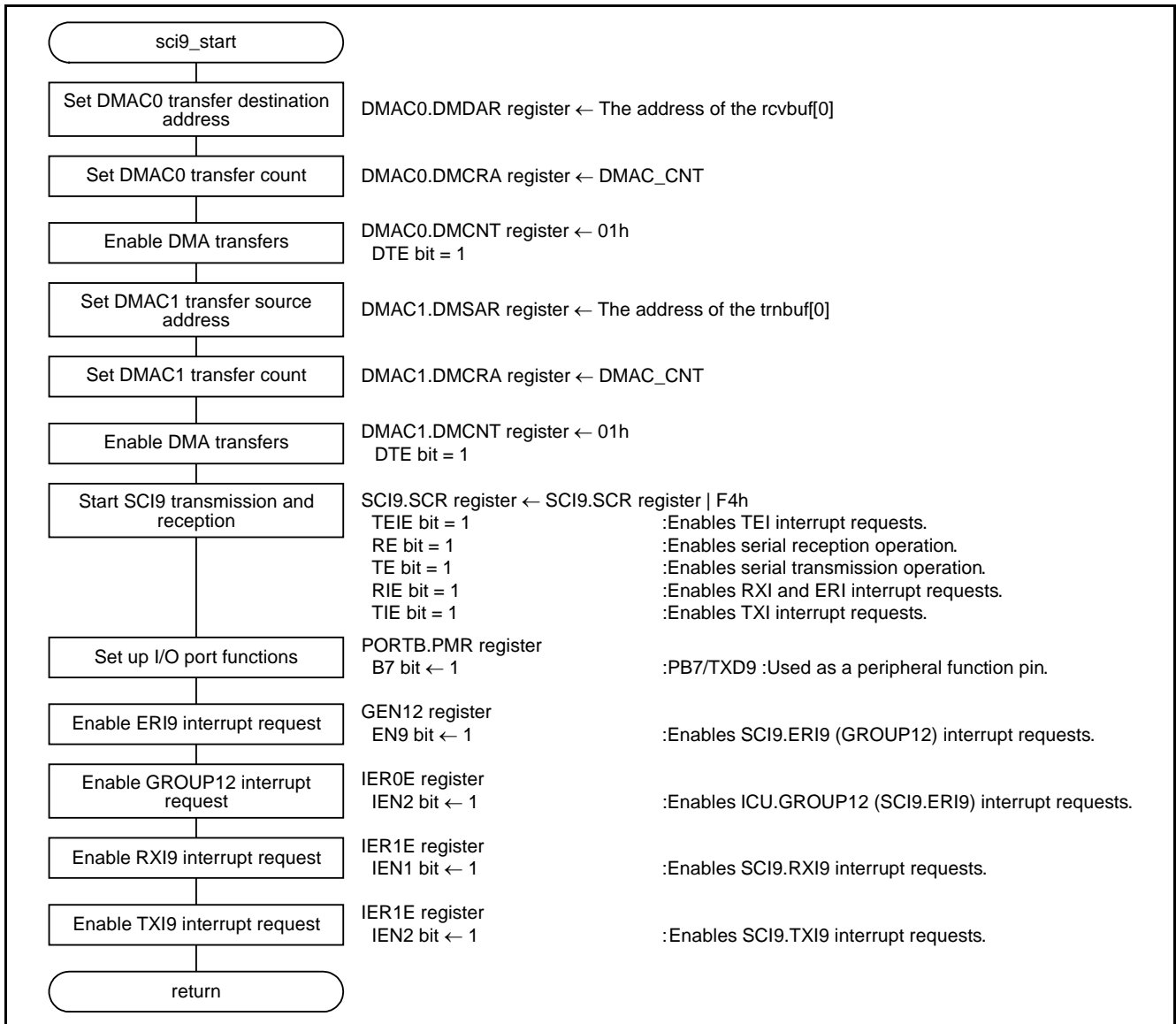

Figure 5.9 SCI9 Transmission and Reception Start

5.8.8 DMAC0 Transfer Complete Interrupt Handler

Figure 5.10 shows the flowchart for the DMAC0 transfer complete interrupt handler.

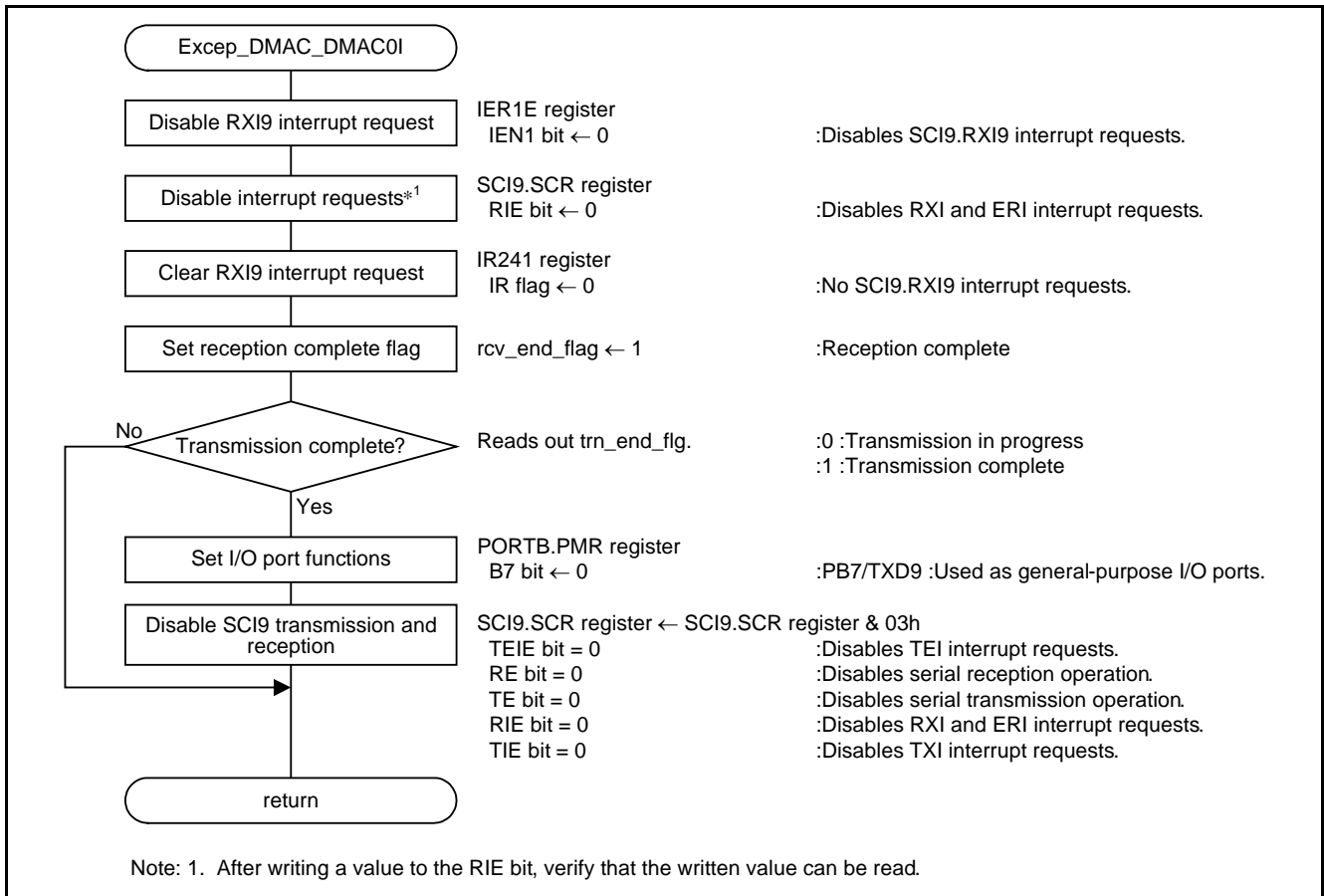

Figure 5.10 DMAC0 Transfer Complete Interrupt Handler

5.8.9 DMAC1 Transfer Complete Interrupt Handler

Figure 5.11 shows the flowchart for the DMAC1 transfer complete interrupt handler.

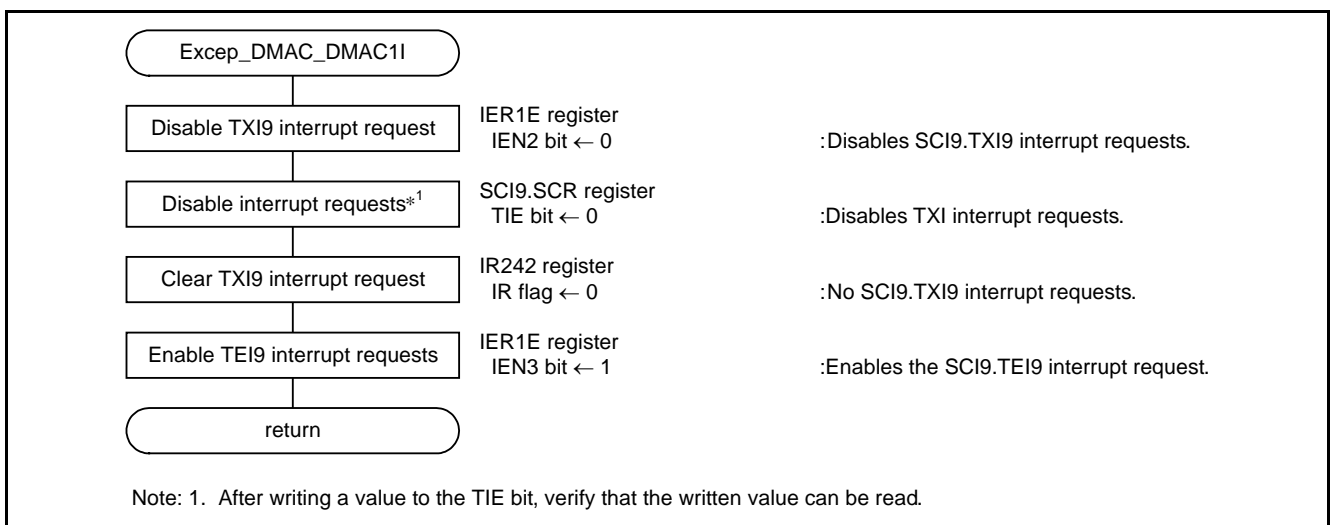

Figure 5.11 DMAC1 Transfer Complete Interrupt Handler



5.8.10 SCI9 Transmission Complete Interrupt Handler

Figure 5.12 shows the flowchart for the SCI9 transmission complete interrupt handler.

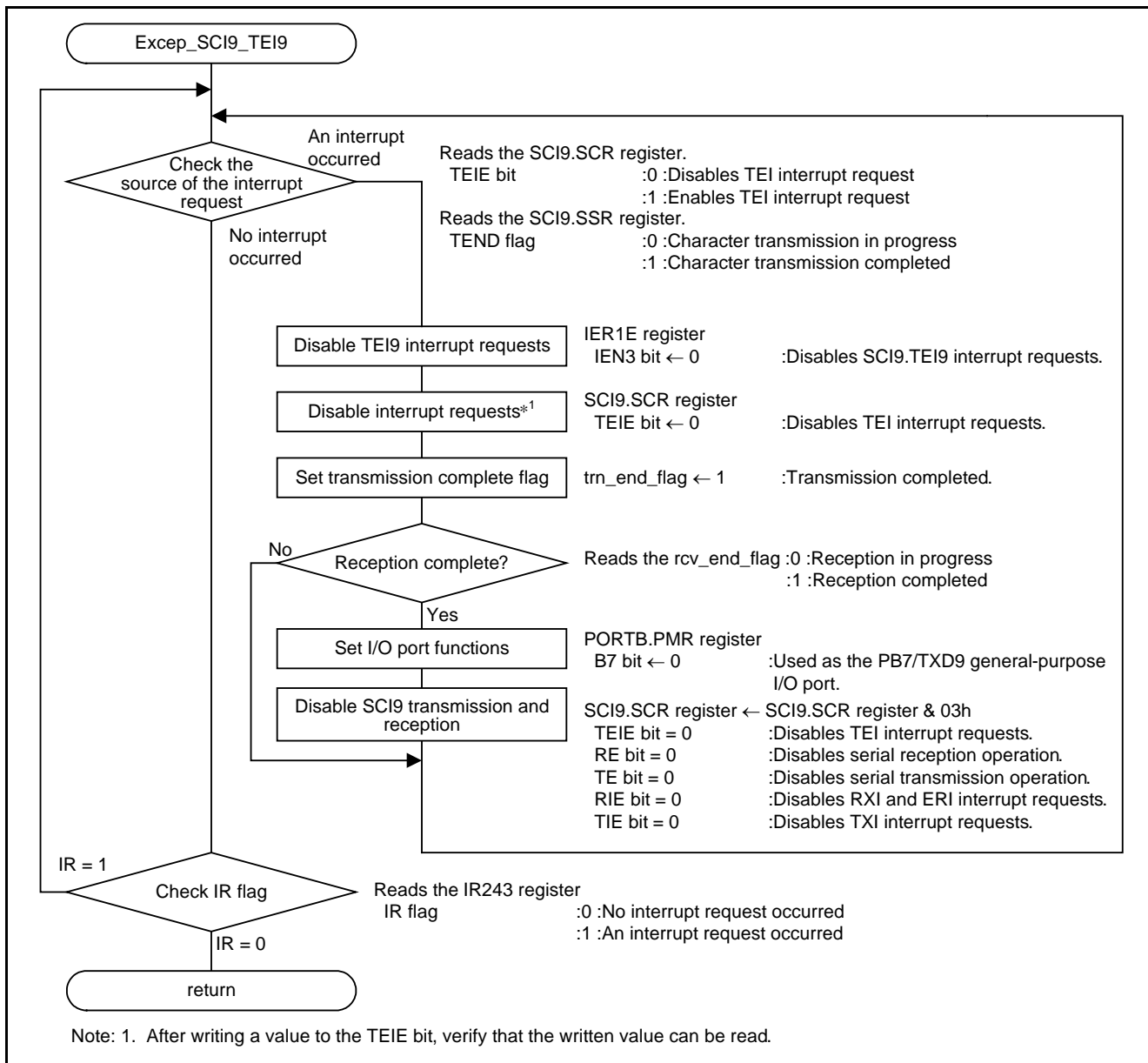

Figure 5.12 SCI9 Transmission Complete Interrupt Handler

5.8.11 Group 12 Interrupt Handler (SCI9 Reception Error Interrupt)

Figure 5.13 shows the flowchart for the Group 12 interrupt handler (SCI9 reception error interrupt).

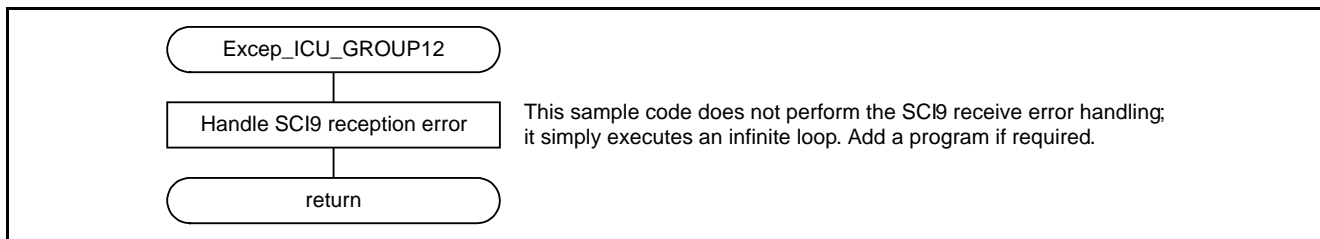

Figure 5.13 Group 12 Interrupt Handler (SCI9 Reception Error Interrupt)

## 6. Sample Code

Sample code can be downloaded from the Renesas Electronics website.

## 7. Reference Documents

User's Manual: Hardware

RX630 Group User's Manual: Hardware Rev.1.50 (R01UH0040EJ)

The latest version can be downloaded from the Renesas Electronics website.

Technical Update/Technical News

The latest information can be downloaded from the Renesas Electronics website.

User's Manual: Development Tools

RX Family C/C++ Compiler Package V.1.01 User's Manual Rev.1.00 (R20UT0570EJ)

The latest version can be downloaded from the Renesas Electronics website.

## Website and Support

Renesas Electronics website

<http://www.renesas.com>

Inquiries

<http://www.renesas.com/contact/>

<b>REVISION HISTORY</b>	RX630 Group Application Note Clock Synchronous SC1c Communication Using the DMACA
-------------------------	--

Rev.	Date	Description	
		Page	Summary
1.00	Apr. 05, 2013	—	First edition issued

All trademarks and registered trademarks are the property of their respective owners.

## General Precautions in the Handling of MPU/MCU Products

The following usage notes are applicable to all MPU/MCU products from Renesas. For detailed usage notes on the products covered by this document, refer to the relevant sections of the document as well as any technical updates that have been issued for the products.

### 1. Handling of Unused Pins

Handle unused pins in accord with the directions given under Handling of Unused Pins in the manual.

- The input pins of CMOS products are generally in the high-impedance state. In operation with an unused pin in the open-circuit state, extra electromagnetic noise is induced in the vicinity of LSI, an associated shoot-through current flows internally, and malfunctions occur due to the false recognition of the pin state as an input signal become possible. Unused pins should be handled as described under Handling of Unused Pins in the manual.

### 2. Processing at Power-on

The state of the product is undefined at the moment when power is supplied.

- The states of internal circuits in the LSI are indeterminate and the states of register settings and pins are undefined at the moment when power is supplied.

In a finished product where the reset signal is applied to the external reset pin, the states of pins are not guaranteed from the moment when power is supplied until the reset process is completed. In a similar way, the states of pins in a product that is reset by an on-chip power-on reset function are not guaranteed from the moment when power is supplied until the power reaches the level at which resetting has been specified.

### 3. Prohibition of Access to Reserved Addresses

Access to reserved addresses is prohibited.

- The reserved addresses are provided for the possible future expansion of functions. Do not access these addresses; the correct operation of LSI is not guaranteed if they are accessed.

### 4. Clock Signals

After applying a reset, only release the reset line after the operating clock signal has become stable. When switching the clock signal during program execution, wait until the target clock signal has stabilized.

- When the clock signal is generated with an external resonator (or from an external oscillator) during a reset, ensure that the reset line is only released after full stabilization of the clock signal. Moreover, when switching to a clock signal produced with an external resonator (or by an external oscillator) while program execution is in progress, wait until the target clock signal is stable.

### 5. Differences between Products

Before changing from one product to another, i.e. to a product with a different part number, confirm that the change will not lead to problems.

- The characteristics of an MPU or MCU in the same group but having a different part number may differ in terms of the internal memory capacity, layout pattern, and other factors, which can affect the ranges of electrical characteristics, such as characteristic values, operating margins, immunity to noise, and amount of radiated noise. When changing to a product with a different part number, implement a system-evaluation test for the given product.

## Notice

1. Descriptions of circuits, software and other related information in this document are provided only to illustrate the operation of semiconductor products and application examples. You are fully responsible for the incorporation of these circuits, software, and information in the design of your equipment. Renesas Electronics assumes no responsibility for any losses incurred by you or third parties arising from the use of these circuits, software, or information.
2. Renesas Electronics has used reasonable care in preparing the information included in this document, but Renesas Electronics does not warrant that such information is error free. Renesas Electronics assumes no liability whatsoever for any damages incurred by you resulting from errors in or omissions from the information included herein.
3. Renesas Electronics does not assume any liability for infringement of patents, copyrights, or other intellectual property rights of third parties by or arising from the use of Renesas Electronics products or technical information described in this document. No license, express, implied or otherwise, is granted hereby under any patents, copyrights or other intellectual property rights of Renesas Electronics or others.
4. You should not alter, modify, copy, or otherwise misappropriate any Renesas Electronics product, whether in whole or in part. Renesas Electronics assumes no responsibility for any losses incurred by you or third parties arising from such alteration, modification, copy or otherwise misappropriation of Renesas Electronics product.
5. Renesas Electronics products are classified according to the following two quality grades: "Standard" and "High Quality". The recommended applications for each Renesas Electronics product depends on the product's quality grade, as indicated below.  
"Standard": Computers; office equipment; communications equipment; test and measurement equipment; audio and visual equipment; home electronic appliances; machine tools; personal electronic equipment; and industrial robots etc.  
"High Quality": Transportation equipment (automobiles, trains, ships, etc.); traffic control systems; anti-disaster systems; anti-crime systems; and safety equipment etc.  
Renesas Electronics products are neither intended nor authorized for use in products or systems that may pose a direct threat to human life or bodily injury (artificial life support devices or systems, surgical implantations etc.), or may cause serious property damages (nuclear reactor control systems, military equipment etc.). You must check the quality grade of each Renesas Electronics product before using it in a particular application. You may not use any Renesas Electronics product for any application for which it is not intended. Renesas Electronics shall not be in any way liable for any damages or losses incurred by you or third parties arising from the use of any Renesas Electronics product for which the product is not intended by Renesas Electronics.
6. You should use the Renesas Electronics products described in this document within the range specified by Renesas Electronics, especially with respect to the maximum rating, operating supply voltage range, movement power voltage range, heat radiation characteristics, installation and other product characteristics. Renesas Electronics shall have no liability for malfunctions or damages arising out of the use of Renesas Electronics products beyond such specified ranges.
7. Although Renesas Electronics endeavors to improve the quality and reliability of its products, semiconductor products have specific characteristics such as the occurrence of failure at a certain rate and malfunctions under certain use conditions. Further, Renesas Electronics products are not subject to radiation resistance design. Please be sure to implement safety measures to guard them against the possibility of physical injury, and injury or damage caused by fire in the event of the failure of a Renesas Electronics product, such as safety design for hardware and software including but not limited to redundancy, fire control and malfunction prevention, appropriate treatment for aging degradation or any other appropriate measures. Because the evaluation of microcomputer software alone is very difficult, please evaluate the safety of the final products or systems manufactured by you.
8. Please contact a Renesas Electronics sales office for details as to environmental matters such as the environmental compatibility of each Renesas Electronics product. Please use Renesas Electronics products in compliance with all applicable laws and regulations that regulate the inclusion or use of controlled substances, including without limitation, the EU RoHS Directive. Renesas Electronics assumes no liability for damages or losses occurring as a result of your noncompliance with applicable laws and regulations.
9. Renesas Electronics products and technology may not be used for or incorporated into any products or systems whose manufacture, use, or sale is prohibited under any applicable domestic or foreign laws or regulations. You should not use Renesas Electronics products or technology described in this document for any purpose relating to military applications or use by the military, including but not limited to the development of weapons of mass destruction. When exporting the Renesas Electronics products or technology described in this document, you should comply with the applicable export control laws and regulations and follow the procedures required by such laws and regulations.
10. It is the responsibility of the buyer or distributor of Renesas Electronics products, who distributes, disposes of, or otherwise places the product with a third party, to notify such third party in advance of the contents and conditions set forth in this document, Renesas Electronics assumes no responsibility for any losses incurred by you or third parties as a result of unauthorized use of Renesas Electronics products.
11. This document may not be reproduced or duplicated in any form, in whole or in part, without prior written consent of Renesas Electronics.
12. Please contact a Renesas Electronics sales office if you have any questions regarding the information contained in this document or Renesas Electronics products, or if you have any other inquiries.

(Note 1) "Renesas Electronics" as used in this document means Renesas Electronics Corporation and also includes its majority-owned subsidiaries.

(Note 2) "Renesas Electronics product(s)" means any product developed or manufactured by or for Renesas Electronics.



### SALES OFFICES

Renesas Electronics Corporation

<http://www.renesas.com>

Refer to "<http://www.renesas.com/>" for the latest and detailed information.

**Renesas Electronics America Inc.**  
2880 Scott Boulevard Santa Clara, CA 95050-2554, U.S.A.  
Tel: +1-408-588-6000, Fax: +1-408-588-6130

**Renesas Electronics Canada Limited**  
1101 Nicholson Road, Newmarket, Ontario L3Y 9C3, Canada  
Tel: +1-905-898-5441, Fax: +1-905-898-3220

**Renesas Electronics Europe Limited**  
Dukes Meadow, Millboard Road, Bourne End, Buckinghamshire, SL8 5FH, U.K.  
Tel: +44-1628-651-700, Fax: +44-1628-651-804

**Renesas Electronics Europe GmbH**  
Arcadiastrasse 10, 40472 Düsseldorf, Germany  
Tel: +49-211-65030, Fax: +49-211-6503-1327

**Renesas Electronics (China) Co., Ltd.**  
7th Floor, Quantum Plaza, No.27 ZhiChunLu Haidian District, Beijing 100083, P.R.China  
Tel: +86-10-8235-1155, Fax: +86-10-8235-7679

**Renesas Electronics (Shanghai) Co., Ltd.**  
Unit 204, 205, AZIA Center, No.1233 Lujiazui Ring Rd., Pudong District, Shanghai 200120, China  
Tel: +86-21-5877-1818, Fax: +86-21-6887-7858 / -7898

**Renesas Electronics Hong Kong Limited**  
Unit 1601-1613, 16/F., Tower 2, Grand Century Place, 193 Prince Edward Road West, Mongkok, Kowloon, Hong Kong  
Tel: +852-2886-9318, Fax: +852 2886-9022/9044

**Renesas Electronics Taiwan Co., Ltd.**  
13F, No. 363, Fu Shing North Road, Taipei, Taiwan  
Tel: +886-2-8175-9600, Fax: +886 2-8175-9670

**Renesas Electronics Singapore Pte. Ltd.**  
80 Bendemeer Road, Unit #06-02 Hyflux Innovation Centre Singapore 339949  
Tel: +65-6213-0200, Fax: +65-6213-0300

**Renesas Electronics Malaysia Sdn.Bhd.**  
Unit 906, Block B, Menara Amcorp, Amcorp Trade Centre, No. 18, Jln Persiaran Barat, 46050 Petaling Jaya, Selangor Darul Ehsan, Malaysia  
Tel: +60-3-7955-9390, Fax: +60-3-7955-9510

**Renesas Electronics Korea Co., Ltd.**  
11F., Samik Lavied' or Bldg., 720-2 Yeoksam-Dong, Kangnam-Ku, Seoul 135-080, Korea  
Tel: +82-2-558-3737, Fax: +82-2-558-5141