

GreenPAK™

Configurable Mixed-Signal Matrix



GreenPAK IC BENEFITS

GreenPAK, a member of Renesas' Configurable Mixed-Signal Matrix products, is a cost-effective one-time NVM programmable device which enables innovators to integrate many system functions while minimizing component count, board space, and power consumption.

Using GreenPAK Designer software and GreenPAK Development Kit, designers can create and program a custom circuit in minutes.

Now supporting automotive grade GreenPAK devices.

 Faster time to market	 Improved noise performance	 Lower cost for designs
 BOM & design size reduction	 Design security	 Reduced power consumption
 Decrease probability of design failure (POF)	 Adaptable & flexible design	 Improve thermal performance
 No NRE	 No production commitment	 Custom datasheet

GreenPAK Design Integration

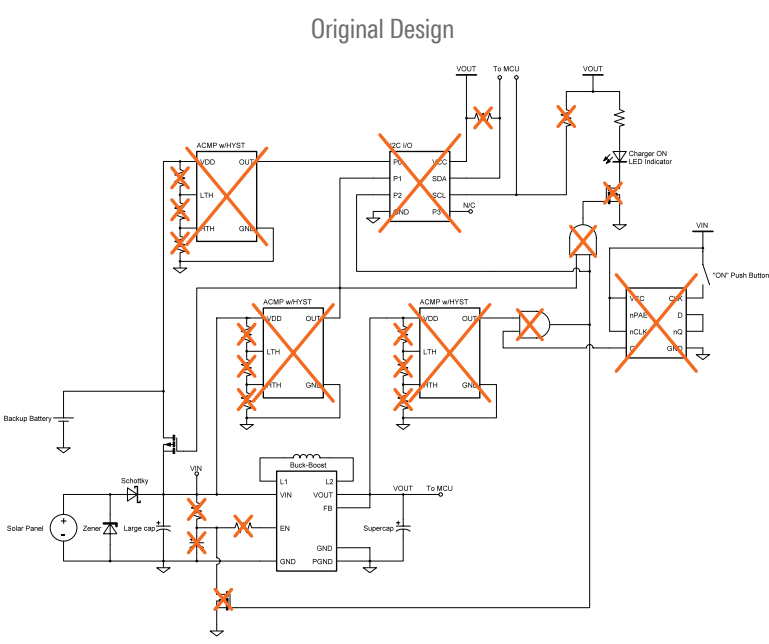

Optimized GreenPAK Design

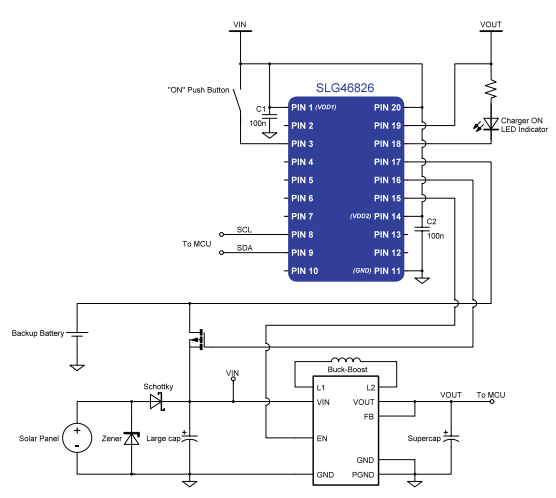

Design reduced by
 - 5 ICs
 - 2 NMOS transistors
 - 14 passive components

UNIQUE FUNCTIONS & FEATURES ALL-IN-ONE PACKAGE

The GreenPAK family of products empowers designers to implement one, or a combination of many, numerous functions and features into their design. Some examples include:

Analog









- Analog switch
- Battery charge indicator
- Comparators
- Current sense/limiter
- LDOs
- Low voltage indicator
- Logic (Mux, gates, etc.)
- OpAmp
- Over-temp detection
- Potentiometer
- Rheostat
- Voltage level detection
- Wake/sleep function
- and More

Digital

- Control
- Deserialization/serialization
- Frequency detection
- Frequency divider
- GPIOs (6-28)
- H-/Half-Bridge
- I²C expansion
- Interrupt
- LED driving/pattern
- Level shifting
- Motor driving
- Pattern generator
- PWM generation
- Sequencer
- SPI or I²C Communication
- System reset
- Watchdog timer
- and More

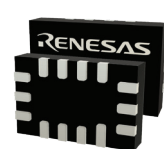
Offerings Include:

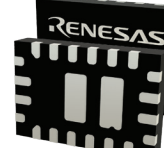
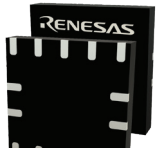
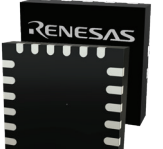
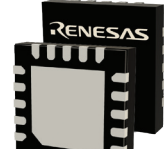
- Automotive qualified
- Multi-time or One-time programmable
- Single or Dual Supply

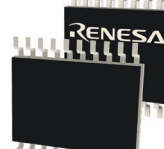
 1.0 mm x 1.2 mm 8-pin STQFN 0.4 mm pitch	 1.6 mm x 1.6 mm 12-pin STQFN 0.4 mm pitch	 1.6 mm x 2.0 mm 16-pin MSTQFN 0.4 mm pitch	 1.6 mm x 2.0 mm 14-pin STQFN 0.4 mm pitch
 1.6 mm x 2.5 mm 14-pin STQFN 0.4 mm pitch	 2.0 mm x 2.2 mm 14-pin STQFN 0.4 mm pitch	 2.0 mm x 2.2 mm 22-pin MSTQFN 0.4 mm pitch	 2.0 mm x 3.0 mm 20-pin STQFN 0.4 mm pitch
 3.0 mm x 3.0 mm 14-pin FCQFN 0.65 mm pitch	 3.0 mm x 3.0 mm 24-pin STQFN 0.4 mm pitch	 3.5 mm x 3.5 mm 20-pin TQFN 0.5 mm pitch	 4.0 mm x 4.0 mm 32-pin STQFN 0.4 mm pitch
			 6.5 mm x 6.4 mm 20-pin TSSOP 0.65 mm pitch

*more packages available

DEVELOPMENT SOFTWARE

Renesas' Go Configure™ Software Hub development software enables a completely graphical design process, requiring no programming language or compiler, allowing a designer to configure, program, and test custom GreenPAK samples in minutes.

- Schematic capture-like design and routing
- Entire component library showing available resources for each device
- Easy component configuration
- Example projects and support documentation
- Simulation capability with external components

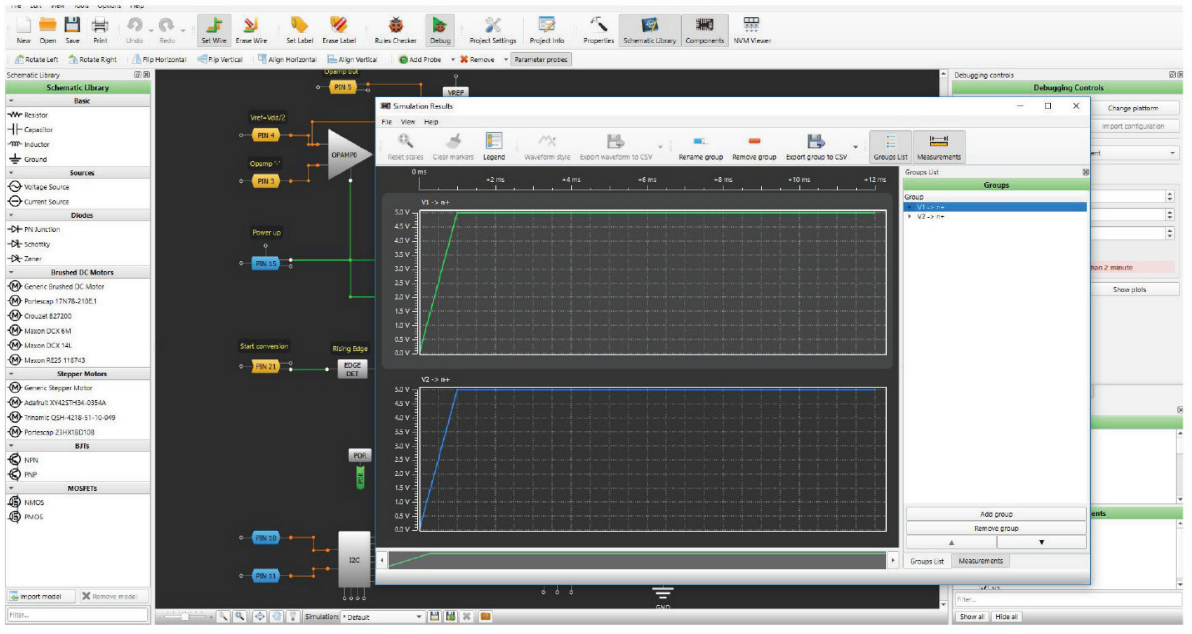

[Download Go Configure™ Software Hub](#)

[View the Software User Guide](#)

Step 1

Place unprogrammed GreenPAK into socket

Step 2

Design your IC with GreenPAK GUI

Step 3

Click **Program** to freeze GreenPAK's NVM

Step 4

Your custom IC is ready for use

GreenPAK TOOLS

There are four development boards that allow engineers to develop their custom designs using GreenPAK mixed-signal ICs. You can design your own projects starting from a blank project, or by altering the sample projects provided at [renesas.com](https://www.renesas.com).

Board/Functions	Features
<p>GreenPAK Lite Development Board Programs custom samples in minutes and works with both DIP and socket adapters.</p>	<ul style="list-style-type: none"> • USB 2.0 board power and communication • Dual VDD IC's support • Onboard PIN LED state indication, Pull-up, Pull-down, GND, VDD, Hi-Z, VDD2, and a programmable software button • Gated expansion header for connection to external test equipment
<p>GreenPAK Advanced Development Platform Program custom samples in minutes using any GreenPAK device.</p>	<ul style="list-style-type: none"> • USB interface • MacOS, Windows and Linux compatible • Programming and Emulation • Gated expansion header for connection to external test equipment • Integrated signal and logic generators LEDs for visual indication
<p>GreenPAK Serial Debugger Board (GSD) Serial debugging for all GreenPAK parts with I²C.</p>	<ul style="list-style-type: none"> • USB interface for power and control • 4 pin header with I²C interface to target system • MacOS, Windows and Linux compatible • GSD supports serial programming for SLG46824, SLG46826, and SLG47004.
<p>GreenPAK DIP Development Platform Perfect for breadboarding and fast prototypes.</p>	<ul style="list-style-type: none"> • USB interface • MacOS, Windows and Linux compatible • Programming and Emulation • Gated expansion header for connection to external test equipment

The evaluation board for the SLG47004 is designed to prototype basic analog configurations of SLG47004 with user-defined circuits and parameters.

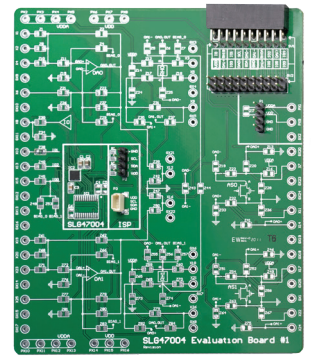

SLG47004V-EVB
GreenPAK SLG47004V Evaluation Board

The HVPACK™ Demo Board allows testing designs based on SLG47105 which drives the built-in DC and stepper motors, along with enabling the LED control.

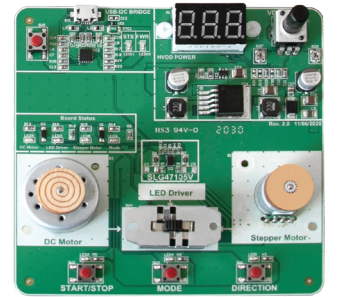

SLG47105V-DMO
HVPACK SLG47105 Demonstration Board

GreenPAK PORTFOLIO

Configurable Mixed-Signal Matrix	SLG46108	SLG46110	SLG46120	SLG46140	SLG46169
Memory Type	OTP	OTP	OTP	OTP	OTP
Temperature Range (°C)	-40 to +85	-40 to +85	-40 to +85	-40 to +85	-40 to +85
# of GPIOs	6	8	10 *	12	12
Operating Voltage (V)	1.71 to 5.5	1.71 to 5.5	1.71 to 5.5	1.71 to 5.5	1.71 to 5.5
Dual Supply (VDD2 1.8 V to VDD)	–	–	SLG46121 *	–	–
8-bit SAR ADC	–	–	–	–	–
Analog/Digital Comparators	–	2/0	2/0	2/3	2/3
Maximum Look Up Tables (LUTs)	10	10	16	16	18
Maximum Counters/Delays	4	4	4	4	7
Maximum DFF / Latch	4	4	8	6	6
PWMs	–	–	–	3	–
Pipe Delay	–	8-stage	8-stage	16-stage	16-stage
Programmable Delay	1	1	1	1	1
Internal Oscillator (Hz)	25 k / 2 M	25 k / 2 M	25 k / 2 M	1.7 k / 25 k / 2 M / 27 M	25 k / 2 M
Asynchronous State Machine	–	–	–	–	–
Communication Interface	–	–	–	SPI	–
QFN Part Number	SLG46108V	SLG46110V	SLG46120V SLG46121V	SLG46140V	SLG46169V
QFN Package Size (mm)	1.0 x 1.2 x 0.55, 0.4 pitch	1.6 x 1.6 x 0.55, 0.4 pitch	1.6 x 1.6 x 0.55, 0.4 pitch	1.6 x 2.0 x 0.55, 0.4 pitch	2.0 x 2.2 x 0.55, 0.4 pitch
Alternate Package Part Number	–	–	SLG46120P	–	–
Alternate Package Type and Size (mm)	–	–	STQFN 2.0 x 2.0 x 0.55, 0.5 pitch	–	–

Configurable Mixed-Signal Matrix	SLG46170	SLG46533	SLG46534	SLG46536	SLG46537
Memory Type	OTP	OTP	OTP	OTP	OTP
Temperature Range (°C)	-40 to +85	-40 to +85	-40 to +85	-40 to +85	-40 to +85
# of GPIOs	12	18	12 *	12	18 *
Operating Voltage (V)	1.71 to 5.5	1.71 to 5.5	1.71 to 5.5	1.71 to 5.5	1.71 to 5.5
Dual Supply (VDD2 1.8 V to VDD)	–	–	SLG46535 *	–	SLG46538 *
8-bit SAR ADC	–	–	–	–	–
Analog/Digital Comparators	–	4/0	3/0	3/0	4/0
Maximum Look Up Tables (LUTs)	17	25	17	25	17
Maximum Counters/Delays	8	7	7	7	7
Maximum DFF / Latch	6	15	8	15	8
PWMs	–	–	–	–	–
Pipe Delay	16-stage	16-stage	16-stage	16-stage	16-stage
Programmable Delay	1	1	1	1	1
Internal Oscillator (Hz)	25 k / 2 M	25 k / 2 M / 25 M	25 k / 2 M / 25 M	25 k / 2 M / 25 M	25 k / 2 M / 25 M
Asynchronous State Machine	–	–	8-State	–	8-State
Communication Interface	–	I ² C	I ² C	I ² C	I ² C
QFN Part Number	SLG46170V	SLG46533V	SLG46534V SLG46535V	SLG46536V	SLG46537V SLG46538V
QFN Package Size (mm)	2.0 x 2.2 x 0.55, 0.4 pitch	2.0 x 3.0 x 0.55, 0.4 pitch	2.0 x 2.2 x 0.55, 0.4 pitch	2.0 x 2.2 x 0.55, 0.4 pitch	2.0 x 3.0 x 0.55, 0.4 pitch
Alternate Package Part Number	–	SLG46533M	–	–	SLG46537M SLG46538M
Alternate Package Type and Size (mm)	–	MSTQFN 2.0 x 2.2 x 0.55, 0.4 pitch	–	–	MSTQFN 2.0 x 2.2 x 0.55, 0.4 pitch

*Dual Supply versions lose one GPIO for VDD2

GreenPAK PORTFOLIO

Configurable Mixed-Signal Matrix	SLG46620	SLG46721	SLG46722	SLG46811	SLG46855
Memory Type	OTP	OTP	OTP	OTP	OTP
Temperature Range (°C)	-40 to +85	-40 to +85	-40 to +85	-40 to +85	-40 to +85
# of GPIOs	18 *	18	18	10	12
Operating Voltage (V)	1.8 to 5.5	1.8 to 5.5	1.8 to 5.5	2.3 to 5.5	2.3 to 5.5
Dual Supply (VDD2 1.8 V to VDD)	SLG46621 *	–	–	–	–
8-bit SAR ADC	1	–	–	–	–
Analog/Digital Comparators	6/3	4/0	–	1(4)/0	4/0
Maximum Look Up Tables (LUTs)	26	18	17	18	23
Maximum Counters/Delays	10	7	8	6	8
Maximum DFF / Latch	12	6	6	17	21
PWMs	3	–	–	–	–
Pipe Delay	2 x 16-stage	16-stage	16-stage	4 Shift Registers	16-stage
Programmable Delay	2	1	1	1	1
Internal Oscillator (Hz)	1.7 k / 25 k / 2 M / 27 M	25 k / 2 M	25 k / 2 M	2 k / 10 k / 25 M	2 k / 2 M / 25 M
Asynchronous State Machine	–	–	–	–	–
Communication Interface	SPI	–	–	–	I ² C
QFN Part Number	SLG46620V SLG46621V	SLG46721V	SLG46722V	SLG46811V	SLG46855V
QFN Package Size (mm)	2.0 x 3.0 x 0.55, 0.4 pitch	2.0 x 3.0 x 0.55, 0.4 pitch	2.0 x 3.0 x 0.55, 0.4 pitch	1.6 x 1.6 x 0.55, 0.4 pitch	1.6 x 2.0 x 0.55, 0.4 pitch
Alternate Package Part Number	SLG46620G	–	–	–	–
Alternate Package Type and Size (mm)	TSSOP 6.5 x 6.4 x 1.2, 0.65 pitch	–	–	–	–

Configurable Mixed-Signal Matrix	SLG46824	SLG46826	SLG46880	SLG46881	SLG47512 SLG47513	SLG47525 SLG47528
Memory Type	MTP	MTP	OTP	OTP	OTP	OTP
Temperature Range (°C)	-40 to +85	-40 to +85	-40 to +85	-40 to +85	-40 to +85	-40 to +85
# of GPIOs	17	17	28	28	10 (SLG47512) 14 (SLG47513)	17/11
Operating Voltage (V)	2.3 to 5.0	2.3 to 5.0	2.3 to 5.0	2.3 to 5.0	1.0 to 1.65	1.71 to 5.5
Dual Supply (VDD2 1.8 V to VDD)	1.71 to VDD	1.71 to VDD	2.3 to 5.0	0.95 to 1.98	–	0.95 to 1.98
8-bit SAR ADC	–	–	–	–	–	–
Analog/Digital Comparators	2/0	4/0	5/0	5/0	2/0	4
Maximum Look Up Tables (LUTs)	19	19	12	12	23	17
Maximum Counters/Delays	8	8	5	5	8	7
Maximum DFF / Latch	17	17	5	5	15	8
PWMs	–	–	–	–	–	–
Pipe Delay	16-stage	16-stage	16-stage	16-stage	14 Shift Registers	16-stage
Programmable Delay	1	1	1	1	1	1
Internal Oscillator (Hz)	2 k / 2 M / 25 M	2 k / 2 M / 25 M	2 k / 2 M / 25 M	2 k / 2 M / 25 M	2 k / 25 M	25 k / 2 M / 25 M
Asynchronous State Machine	–	–	12-State	12-State	–	8-State
Communication Interface	I ² C	I ² C	I ² C	I ² C	I ² C	I ² C
QFN Part Number	SLG46824V	SLG46826V	SLG46880V	SLG46881V	SLG47512V	SLG47525V
QFN Package Size (mm)	2.0 x 3.0 x 0.55, 0.4 pitch	2.0 x 3.0 x 0.55, 0.4 pitch	4.0 x 4.0 x 0.55, 0.4 pitch	4.0 x 4.0 x 0.55, 0.4 pitch	1.6 x 1.6 x 0.55, 0.4 mm pitch	2.0 x 2.2 x 0.55, 0.4 pitch
Alternate Package Part Number	SLG46824G	SLG46826G	–	–	SLG47513M	SLG47528V
Alternate Package Type and Size (mm)	TSSOP 6.5 x 6.4 x 1.2, 0.65 pitch	TSSOP 6.5 x 6.4 x 1.2, 0.65 pitch	–	–	MSTQFN 1.6 x 1.6 x 0.55, 0.4 mm pitch	STQFN 2.0 x 3.0 x 0.55, 0.4 pitch

* Dual Supply versions lose one GPIO for VDD2

GreenPAK PORTFOLIO

GreenPAK with Extended Temperature Range	SLG47105-EV	SLG47115-EV	SLG46620-EV	SLG46826-EV	SLG46855-EV	SLG46108-EV
Temperature Range	-40 to +105	-40 to +105	-40 to +105	-40 to +105	-40 to +105	-40 to +105
Memory Type	OTP	OTP	OTP	MTP	OTP	OTP
# of Pins / # of GPIOs	20/8 + 4 x HD	20/8 + 2 x HD	20/18	20/17	14/12	8/6
Operating Voltage, VDD (V)	2.3 to 5.5	2.3 to 5.5	1.8 to 5.0	2.3 to 5.5	2.3 to 5.5	1.71 to 5.5
Dual Supply, VDD2 (V)	3.0 to 13.2	4.5 to 26.4	–	1.71 to VDD	–	–
Analog/Digital Comparators	4/0	3/0	6/3	4/0	4/0	–
Voltage Reference	Trimmed	Trimmed	Trimmed	Trimmed	Trimmed	–
Combo Function Macro-cells	12 Total	12 Total	2 Total	11 Total	13 Total	6 Total
Multi-Function Macro-cells	5 Total	5 Total	–	8 Total	8 Total	–
PWMs	2	2	3	–	–	–
Special Features	HV outputs	HV outputs	8-bit ADC and 2x DAC	2-kbit I ² C compatible serial EEPROM emulation	–	–
Counters/Delays	5	5	10	8	8	4
DFF / Latch	15	15	12	17	20	4
Pipe Delay	16-stage	16-stage	2x16-stage	16-stage	16-stage	8-stage
Programmable Delay	1	1	2	1	1	1
Internal Oscillator (Hz)	2 k / 25 M	2 k / 25 M	1.7k / 25 k / 2 M / 27 M	2 k / 2 M / 25 M	2 k / 2 M / 25 M	25 k / 25 M
Temp Sensor	Yes	Yes	–	Yes	Yes	–
Communication Interface	I ² C	I ² C	SPI	I ² C	I ² C	–
Package Size (mm)	2.0 x 3.0 x 0.55, 0.4 pitch	2.0 x 3.0 x 0.55, 0.4 pitch	2.0 x 3.0 x 0.55, 0.4 pitch	2.0 x 3.0 x 0.55, 0.4 pitch	1.6 x 2.0 x 0.55, 0.4 pitch	1.0 x 1.2 x 0.55, 0.4 pitch
Package Type	STQFN	STQFN	STQFN	STQFN	STQFN	STQFN

GreenPAK PORTFOLIO

Automotive Configurable Mixed-Signal Matrix	SLG46620-A	SLG46625-A	SLG46827-A	SLG46855-A	SLG46857-A	SLG46880-A	SLG47004-A
Memory Type	OTP	OTP	MTP	OTP	OTP	OTP	MTP
Temperature Range (°C)	-40 to +105	-40 to +125	-40 to +105	-40 to +105	-40 to +125	-40 to +125	-40 to +125
# of GPIOs	20/18	20/18	20/17	14/12	14/12	32/28	24/8
Operating Voltage (V)	1.71 to 3.6	1.71 to 5.0	2.3 to 5.5	2.3 to 5.5	2.3 to 5.5	2.3 to 5.5	2.4 to 5.5
Dual Supply	–	–	1.71 to VDD	–	–	2.3 to VDD	–
8-bit SAR ADC	1	1	–	–	–	–	–
Analog/Digital Comparators	6/3	6/3	4/0	4/0	4/0	5/0	3
Maximum Look Up Tables (LUTs)	26	26	19	23	23	12	20
Maximum Counters / Delays	10	10	8	8	8	5	7
Maximum DFF / Latch	12	12	17	21	21	5	18
PWMs	3	3	–	–	–	–	–
Pipe Delay	2 x 16-stage	2 x 16-stage	16-stage	16-stage	16-stage	16-stage	16-stage
Programmable Delay	2	2	1	1	1	1	1
Internal Oscillator (Hz)	1.7 k / 25 k / 2 M / 27 M	1.7 k / 25 k / 2 M / 27 M	2 k / 2 M / 25 M	2 k / 2 M / 25 M	2 k / 2 M / 25 M	2 k / 2 M / 25 M	2 k / 2 M / 25 M
Asynchronous State Machine	–	–	–	–	–	12-State	–
Special Features	2 x DAC	2 x DAC	–	–	–	–	2 x Op-AMP or 1 x In-AMP; 2 x Rheostat; 2 x An Switch; 2-Ch Auto-Trim
Communication Interface	SPI	SPI	I ² C	I ² C	I ² C	I ² C	I ² C
QFN Part Number	–	SLG46625-AP	–	SLG46855-AP	SLG45857-AP	SLG46880-AP	SLG47004-AP
QFN Package Size (mm)	–	3.5 x 3.5 x 0.75, 0.5 pitch	–	3 x 3 x 0.55, 0.65 pitch	3 x 3.1 x 0.75, 0.65 pitch	5 x 5 x 0.75, 0.5 pitch	4 x 4 x 0.75, 0.5 pitch
Alternate Package Type and Size (mm)	TSSOP 6.4 x 6.5 x 1.2, 0.65 pitch	–	TSSOP 6.5 x 6.4 x 1.2, 0.65 pitch	–	–	–	–

GreenPAK PORTFOLIO

Configurable Mixed-Signal Matrix	Power GreenPAK with Load Switches							
	SLG51000	SLG51001	SLG51002	SLG51003	SLG46116/7	SLG46127	SLG46517	SLG46867
General Parameters								
Memory Type	OTP	OTP	OTP	OTP	OTP	OTP	OTP	OTP
# of Pins / # of GPIOs	20 / 6	16 / 4	25 / 6	14 / 5	14 / 7	16 / 6	28 / 16	20 / 12
Operating Voltage (V)	2.8 to 5	2.8 to 5	2.8 to 5	2.8 to 5	1.71 to 5.5	1.71 to 5.5	1.71 to 5.5	2.3 to 5.5
Communication Interface Type	I ² C	I ² C	I ² C	I ² C	–	–	I ² C	I ² C
Communication Interface Voltage	1.2 V - 1.8 V	1.2 V - 1.8 V	1.2 V - 1.8 V	1.2 V - 5 V	–	–	1.2 V - 5 V	1.2 V - 5 V
GPIO Voltage	1.2 V to 1.8 V	1.2 V to 1.8 V	1.2 V to 5.0 V	1.2 V to 5.0 V	1.71 to 5.5 V	1.2 V to 5.0 V	1.2 V to 5 V	1.2 V to 5 V
Package Type	WLCSP	WLCSP	WLCSP	TQFN	TQFN	TQFN	TQFN	TQFN
Package Size (mm)	1.675 x 2.075 x 0.465, 0.4 pitch	1.675 x 1.675 x 0.465, 0.4 pitch	1.992 x 1.992 x 0.44, 0.35 pitch	2.0 x 2.2 x 0.55, 0.4 pitch	1.6 x 2.5 x 0.55, 0.4 pitch	1.6 x 2.0 x 0.55, 0.4 pitch	2.0 x 3.0 x 0.55, 0.4 pitch	1.6 x 3.0 x 0.4, 0.4 pitch
Operating temperature (°C)	-40 to +85	-40 to +85	-40 to +85	-40 to +85	-40 to +85	-40 to +85	-40 to +85	-40 to +85
Combinatorial logic								
Analog Comparators	–	–	–	–	2	2	4	4
Max. Look Up Tables (LUTs) / DFF	12 / -	12 / -	8 / 8	8 / 8	10 / 4	10 / 4	17 / 8	23 / 21
Pipe Delay	–	–	–	–	8-stage	8-stage	16-stage	16-stage
Internal Oscillator (Hz)	8 M	8 M	8 M	8 M	25 k / 2 M	25 k / 2 M	25 k / 2 M / 25 M	25 k / 2 M / 25 M
Max. Counters/Delays	–	–	1 / 4	1 / 4	4	4	7	8
Combination Function Macro-cells	–	–	7	7	6	6	17	15
State Machine	Power Sequencer	Power Sequencer	Power Sequencer	–	–	–	8-state ASM	–
Power Parameters								
# of Load Switches	2	1	5	1	1 Total	2 Total	2 Total	2 x PFET
Load Switch Type (PMOS / NMOS)	2 x NMOS	1 x NMOS	3 x NMOS, 2 x PMOS	1 x NMOS	1 x PMOS	2 x PMOS	2 x PMOS	2 x PMOS
Max Iout	0.8 A	1 A	1.3 A	0.8 A	1.25 A	2 A	2 A	2 A
RON	40 mOhm	40 mOhm	40 mOhm	40 mOhm	28.5 mOhm	44 mOhm	44 mOhm	44 mOhm
Programmable Current Limit	Yes	Yes	Yes	Yes	–	–	–	–
Slew Rate	Yes	Yes	Yes	Yes	Fixed	–	–	–
# of LDOs	7	6	8	3	–	–	–	–
Protection Features	ESD, OCP, OTP, UVLO	ESD, OCP, OTP, UVLO	ESD, OCP, OTP, UVLO	ESD, OCP, OTP, UVLO	ESD, Read Lock	ESD, Read Lock	ESD, Read Lock	ESD, Read Lock
Discharge Resistance	Fixed	Fixed	Programmable	Programmable	W/O Fixed	–	–	–

GreenPAK PORTFOLIO

Configurable Mixed-Signal Matrix

Power GreenPAK with LDOs

Part Number	SLG51000	SLG51001	SLG51002	SLG51003	SLG46580	SLG46582	SLG46583	SLG46585
General Parameters								
Memory Type	OTP	OTP	OTP	OTP	OTP	OTP	OTP	OTP
# of Pins / # of GPIOs	20 / 6	16 / 4	25 / 6	14 / 5	20 / 9	20 / 9	20 / 9	29 / 7
Operating Voltage (V)	2.8 - 5.0	2.8 - 5.0	2.8 - 5.0	2.8 - 5.0	2.3 - 5.5	2.3 - 5.5	2.3 - 5.5	2.5 - 5.5
Communication Interface Type	I ² C	I ² C	I ² C	I ² C	I ² C	I ² C	I ² C	I ² C
Communication Interface Voltage	1.2 V - 1.8 V	1.2 V - 1.8 V	1.2 V - 1.8 V	1.2 V - 5.0 V	1.2 V - 5.5 V	1.2 V - 5.5 V	1.2 V - 5.5 V	1.2 V - 5.5 V
GPIO Voltage	1.2 V to 1.8 V	1.2 V to 1.8 V	1.2 V to 5.0 V	1.2 V - 5.0 V	1.2 V to 5.5 V	1.2 V to 5.5 V	1.2 V to 5.5 V	1.2 V to 5.5 V
Package Type	WLCSP	WLCSP	WLCSP	TQFN	TQFN	TQFN	TQFN	TQFN
Package Size (mm)	1.675 x 2.075 x 0.465, 0.4 pitch	1.675 x 1.675 x 0.465, 0.4 pitch	1.992 x 1.992 x 0.44, 0.35 pitch	2.0 x 2.2 x 0.55, 0.4 pitch	2 x 3 x 0.55, 0.4 pitch	2 x 3 x 0.55, 0.4 pitch	2 x 3 x 0.55, 0.4 pitch	3 x 3 x 0.55, 0.4 pitch
Operating temperature (°C)	-40 to +85	-40 to +85	-40 to +85	-40 to +85	-40 to +85	-40 to +85	-40 to +85	-40 to +85
Power Parameters								
Analog Comparators	–	–	–	–	4	4	4	4
Max. Look Up Tables (LUTs) / DFF	12 / -	12 / -	8 / 8	8 / 8	15 / 9	15 / 9	15 / 9	16 / 9
Pipe Delay	–	–	–	–	16 - stage	16 - stage	16 - stage	16 - stage
Internal Oscillator (Hz)	8 M	8 M	8 M	8 M	1.73 k / 25 k / 2 M	25 k / 2 M	25 k / 2 M	25 k / 2 M
Max. Counters/Delays	–	–	1 / 4	1 / 4	5	5	5	5
Combination Function Macro-cells	–	–	8	7	15	15	15	15
State Machine	Power Sequencer	Power Sequencer	Power Sequencer	–	8-state ASM	8-state ASM	8-state ASM	8-state ASM
Flexible Timing & Event-Triggered Sequencer	Yes	Yes	Yes	Yes	Yes	Yes	Yes	Yes
# LDOs	7	6	8	3	4	2	2	4
VIN total range	0.8 V - 5.0 V	0.8 V - 5.0 V	0.8 V - 5.0 V	0.8 V - 5.0 V	2.3 V - 5.5 V	2.3 V - 5.5 V	2.3 V - 5.5 V	2.5 V - 5.5 V
VOU total range	0.5 V - 3.75 V	0.5 V - 3.75 V	0.5 V - 3.75 V	0.5 V - 3.75 V	0.9 V to 4.35 V	0.9 V to 4.35 V	0.9 V to 4.35 V	0.9 V to 4.2 V
Output Current Max (A)	0.8	1	1.3	0.8	0.15	0.3	0.6	0.15
Max Iout_LDO1 (mA)	475 (High PSRR)	475 (High PSRR)	500	475 (High PSRR)	150	300	600	150
Max Iout_LDO2 (mA)	475 (High PSRR)	500	500	500	150	300	–	150
Max Iout_LDO3 (mA)	500	500	500	800	150	–	–	150
Max Iout_LDO4 (mA)	500	500	500	–	150	–	–	150
Max Iout_LDO5 (mA)	800	500	500	–	–	–	–	–
Max Iout_LDO6 (mA)	800	1000	1A	–	–	–	–	–
Max Iout_LDO7 (mA)	500	–	1 A	–	–	–	–	–
Max Iout_LDO8 (mA)	–	–	1.3 A	–	–	–	–	–
# of Load Switches	2	1	5	1	4	2	1	1
Vdropout	80 mV @ 0.8A (LV LDO)	100 mV @ 1 A (LV LDO)	130 mV @ 1.3 A (LV LDO)	100 mV @ 0.8 A (LV LDO)	250 mV	250 mV	250 mV	250 mV
PSRR	87 dB @ 100 kHz (HP LDO)	87 dB @ 100 kHz (HP LDO)	65 dB @ 100 kHz (HV LDO)	87 dB @ 100 kHz (HP LDO)	50 dB @ 100 Hz to 100k Hz	50 dB @ 100 Hz to 100k Hz	50 dB @ 100 Hz to 100k Hz	50 dB @ 100 Hz to 100k Hz
Output Noise	13 uV @ 10 Hz to 100 kHz (HP LDO)	13 uV @ 10 Hz to 100 kHz (HP LDO)	152 uV @ 10 Hz to 100 kHz (HV LDO)	18 uV @ 10 Hz to 100 kHz (HP LDO)	75 uV @ 10 Hz to 100 kHz	75 uV @ 10 Hz to 100 kHz	75 uV @ 10 Hz to 100 kHz	75 uV @ 10 Hz to 100 kHz
Current limit	Startup & Functional (Programmable)	Startup & Functional (Programmable)	Startup & Functional (Programmable)	Startup & Functional (Programmable)	Over-current & Short-Circuit Detection Current Limit	Over-current & Short-Circuit Detection Current Limit	Over-current & Short-Circuit Detection Current Limit	Over-current & Short-Circuit Detection Current Limit
Protection Features	ESD, OCL, OTP, UVLO	ESD, OCL, OTP, UVLO	ESD, OCL, OTP, UVLO	ESD, OCL, OTP, UVLO	ESD, OCL, SCD, OTP, Read Lock	ESD, OCL, SCD, OTP, Read Lock	ESD, OCL, SCD, OTP, Read Lock	ESD, OCL, SCD, OTP, Read Lock

GreenPAK PORTFOLIO

	HVPAK™	
Configurable Mixed-Signal Matrix	SLG47105	SLG47115
Memory Type	OTP	OTP
Temperature Range (°C)	-40 to +85	-40 to +85
# of GPIOs	8	8
High Voltage High Current Output (HV_GPO_HD)	4 x 1.5 A RMS (2 A Peak) HV_GPO_HD	2 x 1.5 A RMS (3 A Peak) HV_GPO_HD
Operating Voltage (V)	2.3 to 5.5	2.3 to 5.5
Dual Supply (VDD2, V)	3.0 to 13.2	4.5 to 26.4
Abs Max (VDD2, V)	18	32
Analog / Current Sense Comparators / Differential Amplifier	2/2/1	2/1/1
Maximum Look Up Tables (LUTs)	17	17
Maximum Counters/Delays	5	5
Maximum DFF / Latch	15	15
PWMs	2	2
Pipe Delay	16-stage	16-stage
Programmable Delay	1	1
Internal Oscillator (Hz)	2 k / 25 M	2 k / 25 M
Communication Interface	I ² C	I ² C
QFN Package Size (mm)	20-pin, 2.0 x 3.0 x 0.55, 0.4 pitch	20-pin, 2.0 x 3.0 x 0.55, 0.4 pitch

	AnalogPAK™			
Configurable Mixed-Signal Matrix	SLG47001	SLG47003	SLG47004	SLG47011
Memory Type	OTP	OTP	MTP	OTP
Temperature Range (°C)	-40 to +85	-40 to +85	-40 to +85	-40 to +85
# of GPIOs	6	10	8	13
Operating Voltage (V)	2.3 to 5.5	2.3 to 5.5	2.4 to 5.5	1.71 to 3.60
Operational Amplifiers	2	2	3	–
Digital Rheostats (1024 Position), resistance	2 x 100 kΩ	2 x 100 kΩ	2 x 100 kΩ	–
Analog Switch	1	1	2	–
Analog / Current Sense Comparators / Differential Amplifier	6 (1 multi-channel)/0/0	6 (1 multi-channel)/0/0	3/0/0	1/0/0
Width Converter	1 x 8-bit	1 x 8-bit	–	1 x 12-bit
Memory Table	–	–	–	4096 x 12-bit words
ADC	–	–	–	1 x 14-bit
DAC	–	–	–	1 x 12-bit
Data Buffer	–	–	–	4 x 16-bit
MathCore	–	–	–	4 math operations (+, -, x, /)
Maximum Look Up Tables (LUTs)	16	16	20	31
Maximum Counters/Delays	5	5	7	13
Maximum DFF / Latch	16	16	18	31
PWMs	–	–	–	1
Pipe Delay	–	–	16-stage	–
Programmable Delay	1	1	1	1
Internal Oscillator (Hz)	2 k or 10 k / 25 M	2 k or 10 k / 25 M	2.048 k / 2.048 M / 25 M	2 k or 10 k / 20 M or 40 M
Communication Interface	I ² C	I ² C	I ² C	I ² C
QFN Package Size (mm)	20-pin 2.0 x 3.0 x 0.55, 0.4 pitch	24-pin 3.0 x 3.0 x 0.55, 0.4 pitch	24-pin, 3.0 x 3.0 x 0.55, 0.4 pitch	16-pin 2.0 x 2.0 x 0.55, 0.4 pitch

Visit renesas.com/greenpak for more details on the complete portfolio of products, including datasheets, eval boards and samples.



Renesas Electronics America Inc. | renesas.com
6024 Silver Creek Valley Rd, San Jose, CA 95138 | Phone: 1-888-468-3774

© 2024 Renesas Electronics America Inc. (REA). All rights reserved. All trademarks are the property of their respective owners. REA believes the information herein was accurate when given but assumes no risk as to its quality or use. All information is provided as-is without warranties of any kind, whether express, implied, statutory, or arising from course of dealing, usage, or trade practice, including without limitation as to merchantability, fitness for a particular purpose, or non-infringement. REA shall not be liable for any direct, indirect, special, consequential, incidental, or other damages whatsoever, arising from use of or reliance on the information herein, if advised of the possibility of such damages. REA reserves the right, without notice, to discontinue products or make changes to the design or specifications of its products or other information herein. All contents are protected by U.S. and international copyright laws. Except as specifically permitted herein, no portion of this material may be reproduced in any form, or by any means, without prior written permission from Renesas Electronics America Inc. Visitors or users are not permitted to modify, distribute, publish, transmit or create derivative works of any of this material for any public or commercial purposes.