

# TRAY PACKING

## 1. CONTAINER

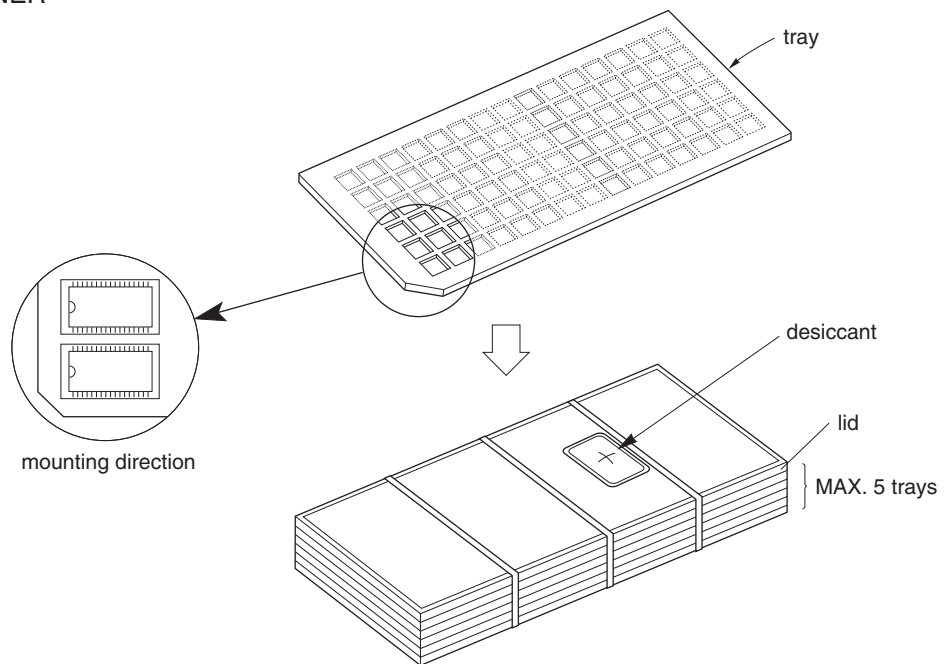

## 2. DRY PACK

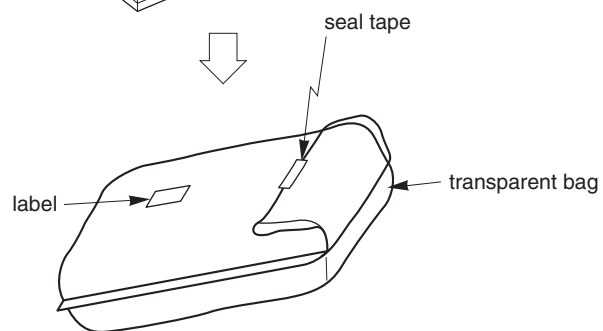

## 3. INNER BOX

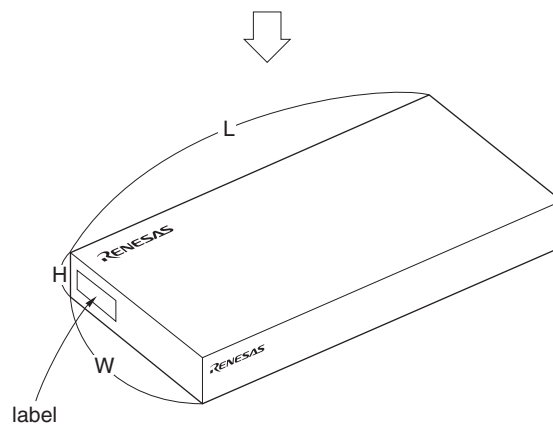

LABEL POSITION	SIDE OF BOX
LABEL	PRODUCT NAME, QUANTITY, LOT NUMBER, CLASS
INNER BOX	DIMENSION (W x L x H) 175 x 375 x 75 (mm)