

PMIC for Applications Requiring up to 6 A

General Description

DA9061 is a power management integrated circuit (PMIC) optimized for supplying systems with single- and dual-core processors, I/O, DDR memory, and peripherals. It targets mobile device, medical equipment, IVI systems, and FPGA based applications.

DA9061 features three buck converters providing a total current of 6 A. High efficiency is achieved over a wide load range with PFM mode available for low power or sleep modes. All power switches are integrated, therefore, external Schottky diodes are not required. Furthermore, low-profile inductors can be used with DA9061. The four LDO regulators with programmable output voltage provide up to 300 mA.

Dynamic voltage control (DVC) allows dynamic control of DA9061 supply voltages according to the operating point of the system. It is controlled by writing directly to the registers using the I²C compatible 2-wire interface or the GPIOs.

DA9061 features a programmable power sequencer that handles start-up and shutdown sequences. Power mode transitions can be triggered with software control, GPIOs, or with the on-key. Several types of on-key presses can be detected to trigger different power mode transitions.

An integrated watchdog timer monitors the system.

Five GPIOs are able to perform system functions, including: keypad supervision, application buck, and timing-controlled external regulators/power switches or other ICs.

DA9061 is also available as an automotive AEC-Q100 Grade 2 version.

Key Features

- Input voltage 2.8 V to 5.5 V
- Three buck converters with dynamic voltage control:
 - Buck1: 0.3 V to 1.57 V, 2.5 A
 - Buck2: 0.8 V to 3.34 V, 2 A
 - Buck3: 0.53 V to 1.8 V, 1.5 A
 - 3 MHz switching frequency (enables low profile inductors)
- Four LDO regulators:
 - LDO1: 0.9 V to 3.6 V, 100 mA
 - LDO2, LDO3, LDO4: 0.9 V to 3.6 V, 300 mA
- Programmable power mode sequencer
- System supply and junction temperature monitoring
- Watchdog timer
- Five GPIOs
- -40 °C to +125 °C junction temperature range
- 40-pin QFN, 6 mm × 6 mm package, 0.5 mm pitch
- Automotive AEC-Q100 Grade 2 version available

Applications

- Single and dual core application processors such as ARM Cortex or i.MX6 series
- Entry-level FPGAs
- Automotive infotainment
- Portable industrial and medical devices
- e-book readers

PMIC for Applications Requiring up to 6 A

Block Diagram

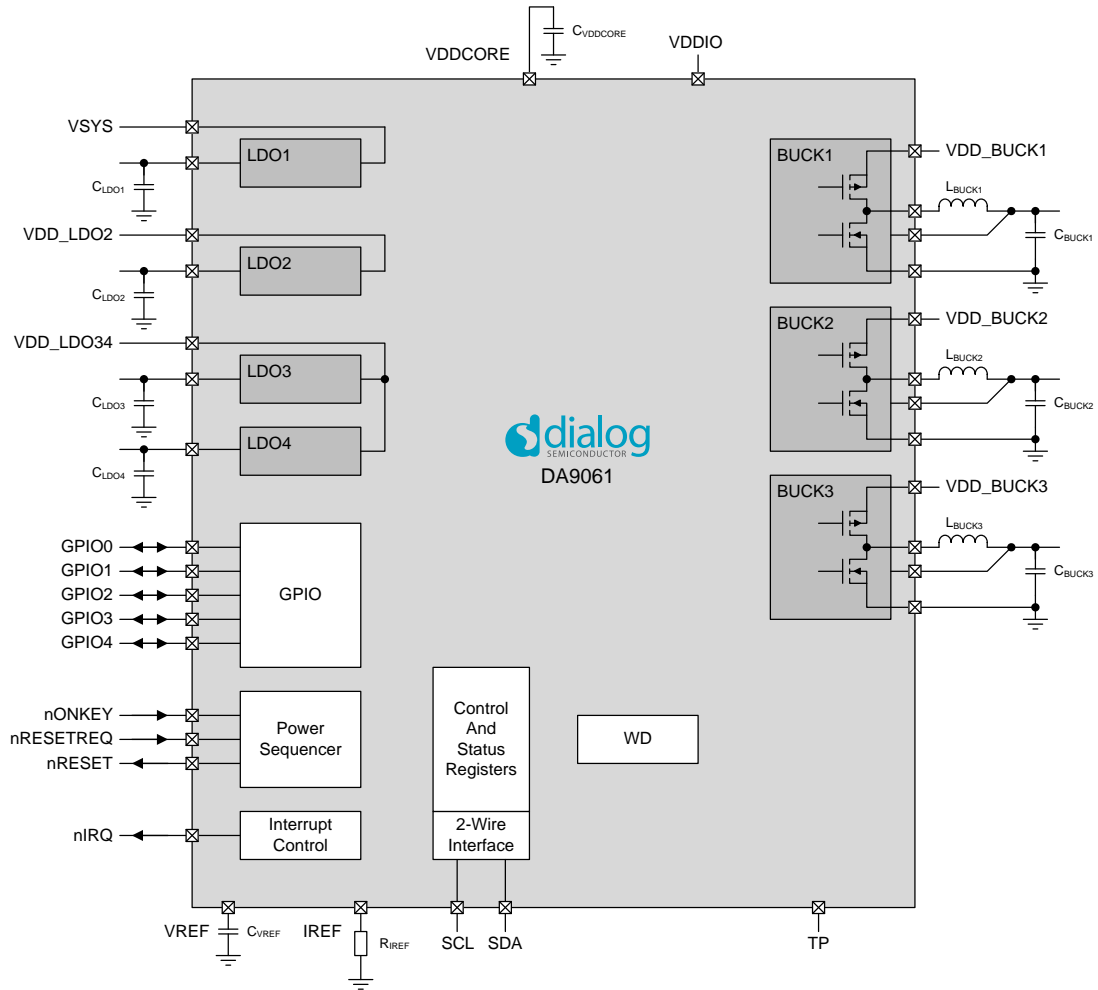

Figure 1: DA9061 Block Diagram

PMIC for Applications Requiring up to 6 A

Contents

General Description	1
Key Features	1
Applications	1
Block Diagram	2
Contents	3
1 Package Information	6
1.1 Pin List.....	6
1.2 Package Outline Drawing.....	8
2 Regulator Overview	9
3 Absolute Maximum Ratings	10
4 Recommended Operating Conditions	11
4.1 Thermal Characteristics	12
4.1.1 Power Derating Curves.....	12
5 Electrical Characteristics	13
5.1 Digital I/O	13
5.2 Watchdog	14
5.3 2-Wire Interface.....	14
5.4 LDOs	16
5.4.1 LDO1.....	16
5.4.2 LDO2, LDO3, LDO4.....	17
5.4.3 LDOCORE	18
5.5 Buck Converters.....	19
5.5.1 Buck1	19
5.5.2 Buck2.....	21
5.5.3 Buck3.....	23
5.6 Internal Oscillator	24
5.7 System Supply Voltage Supervision	25
5.8 Junction Temperature Supervision	25
5.9 Current Consumption	26
6 Typical Characteristics	27
7 Functional Description	29
7.1 Control Signals.....	29
7.1.1 nONKEY	29
7.1.2 nRESETREQ	29
7.1.3 nRESET	30
7.1.4 nIRQ.....	30
7.2 2-Wire Interface.....	30
7.2.1 Register Map Paging	31
7.2.2 Details of the 2-Wire Protocol.....	31
7.3 GPIOs.....	33
7.3.1 GPI Functionality	34
7.3.2 GPO Functionality.....	35
7.3.3 Alternate Functions.....	35

PMIC for Applications Requiring up to 6 A

7.3.4	GPIO Forwarding	36
7.4	Dynamic Voltage Control	36
7.5	Regulator Voltage A and B Selection	36
7.6	LDOs	37
7.6.1	Control	37
7.6.2	Current Limit	37
7.6.3	Output Pull-Down	37
7.7	Switching Regulators	38
7.7.1	Control	38
7.7.2	Output Voltage Slewing	38
7.7.3	Soft-Start	38
7.7.4	Active Discharge	38
7.7.5	Peak Current Limit	38
7.7.6	Operating Mode	39
7.7.7	Half-Current Mode	39
7.8	Power Modes	40
7.8.1	NO-POWER Mode	40
7.8.2	RESET Mode	41
7.8.3	POWERDOWN Mode	42
7.8.4	Power-Up, Power-Down, and Shutdown Sequences	43
7.8.5	ACTIVE Mode	43
7.9	Power Supply Sequencer	44
7.9.1	Programmable Slot Delays	45
7.9.2	Sub-Sequences	45
7.9.3	Regulator Control	45
7.9.4	GPO Control	46
7.9.5	Wait Step	47
7.9.6	Power-Down Disable	47
7.10	Junction Temperature Supervision	47
7.11	System Supply Voltage Supervision	47
7.12	Internal Oscillator	48
7.13	Watchdog	48
8	Register Map	49
8.1	Register Page Control	49
8.2	Overview	49
9	Application Information	52
9.1	Component Selection	52
9.1.1	Resistors	52
9.1.2	Capacitors	52
9.1.3	Inductors	53
9.2	PCB Layout	54
9.2.1	General Recommendations	54
9.2.2	LDOs and Switched Mode Supplies	55
9.2.3	Optimizing Thermal Performance	55
10	Ordering Information	56
11	Package Marking	56

PMIC for Applications Requiring up to 6 A

Appendix A Register Descriptions	57
A.1 PAGE 0	57
A.1.1 Page Control	57
A.1.2 Power Manager Control and Monitoring	57
A.1.3 IRQ Events	58
A.1.4 IRQ Masks	59
A.1.5 System Control	60
A.1.6 GPIO Control	62
A.1.7 Power Supply Control	65
A.2 PAGE 1	70
A.2.1 Power Sequencer	70
A.2.2 Power Supply Control	74
A.3 PAGE 2	78
A.3.1 Customer Trim and Configuration	78
A.3.2 Customer Device Specific	81
A.4 PAGE 3	84
A.4.1 Device Identification	84

PMIC for Applications Requiring up to 6 A

1 Package Information

1.1 Pin List

Table 1: Pin Description

Pin No.	Pin Name	Type Table 2	Description
Paddle	GND	GND	Power grounds of the bucks, digital ground
1	VLDO1	AO	LDO1 output voltage
2	VLDO2	AO	LDO2 output voltage
3	VDD_LDO2	PS	LDO2 supply
4	IREF	AO	Reference current
5	VREF	AIO	Reference voltage
6	NC		Connect to GND
7	VSS_ANA	GND	Analog ground
8	NC		Connect to GND
9	VLDO3	AO	LDO3 output voltage
10	VDD_LDO34	PS	LDO3 and LDO4 supply
11	VLDO4	AO	LDO4 output voltage
12	NC		Do not use. Leave floating
13	SDA	DIO	Data signal of the 2-wire interface
14	SCL	DI	Clock signal of the 2-wire interface
15	nONKEY	DI	Input for power-on key
16	nRESETREQ	DI	Reset request input
17	VLX_BUCK3	AO	Switching node of Buck3
18	VDD_BUCK3	PS	Buck3 supply
19	VDD_BUCK2	PS	Buck2 supply
20	VLX_BUCK2	AO	Switching node of Buck2
21	GPIO0	DIO	General purpose I/O, WDKICK
22	GPIO1	DIO	General purpose I/O
23	VDDIO	PS	IO supply
24	VBUCK3	AI	Voltage feedback of Buck3
25	VBUCK2	AI	Voltage feedback of Buck2
26	VBUCK1	AI	Voltage feedback of Buck1
27	NC		Do not use. Leave floating
28	GPIO2	DIO	General purpose I/O, PWR_EN
29	GPIO3	DIO	General purpose I/O
30	GPIO4	DIO	General purpose I/O, SYS_EN
31	VLX_BUCK1	AO	Switching node of Buck1
32	VDD_BUCK1	PS	Buck1 supply
33	NC		Connect to GND

PMIC for Applications Requiring up to 6 A

Pin No.	Pin Name	Type Table 2	Description
34	NC		Do not use. Leave floating
35	NC		Do not use. Leave floating
36	TP	DIO	Test pin
37	nIRQ	DO	Interrupt signal to host processor
38	nRESET	DO	Reset output
39	VDDCORE	AO	Internal supply
40	VSYS	PS	System supply, LDO1 supply

Table 2: Pin Type Definition

Pin type	Description	Pin type	Description
DI	Digital Input	AI	Analog Input
DO	Digital Output	AO	Analog Output
DIO	Digital Input/Output	AIO	Analog Input/Output
PS	Power Supply	GND	Ground connection

PMIC for Applications Requiring up to 6 A

1.2 Package Outline Drawing

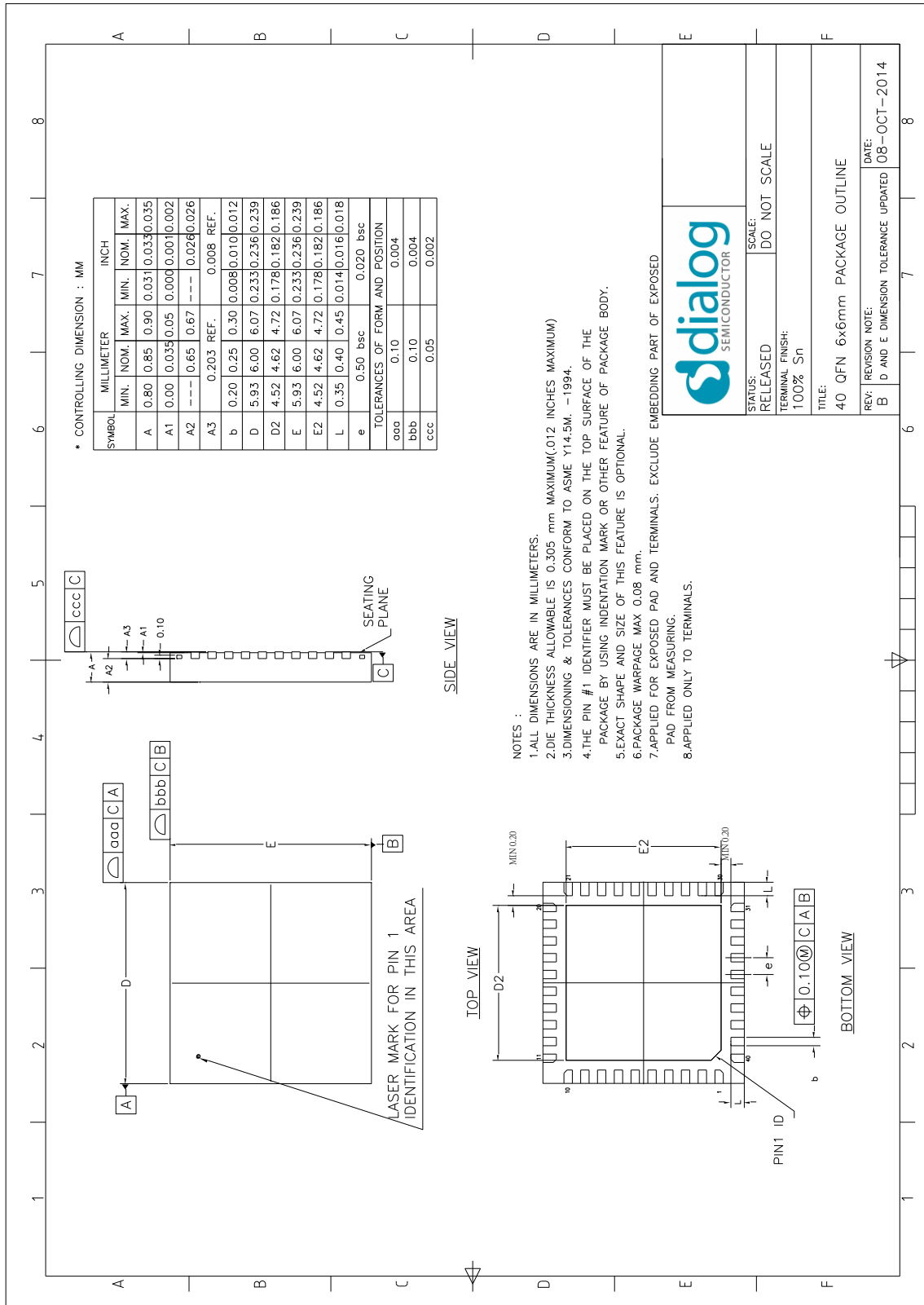

Figure 2: DA9061 Package Outline Drawing

PMIC for Applications Requiring up to 6 A

2 Regulator Overview

Table 3: Regulators

Regulator	Supplied Pins	Supplied Voltage (V)	Supplied Maximum Current (mA)	External Component	Notes
Buck1	VBUCK1	0.3 to 1.57	2500 Note 1	1.0 μ H, 44 μ F/88 μ F	<ul style="list-style-type: none"> GPIO and host interface-controlled DVC with variable slew rate (10 mV in [0.5, 1.0, 2.0, 4.0] μs) 10 mV steps < 0.7 V PFM mode only
Buck2	VBUCK2	0.8 to 3.34	2000 Note 2	1.0 μ H, 44 μ F/88 μ F	<ul style="list-style-type: none"> GPIO and host interface-controlled DVC with variable slew rate (10 mV in [0.5, 1.0, 2.0, 4.0] μs) 20 mV steps
Buck3	VBUCK3	0.53 to 1.8	1500 Note 2	1.0 μ H, 44 μ F	<ul style="list-style-type: none"> GPIO and host interface-controlled DVC with variable slew rate (10 mV in [0.5, 1.0, 2.0, 4.0] μs) 10 mV steps < 0.7 V PFM mode only
LDO1	VLDO1	0.9 to 3.6	100	1.0 μ F	<ul style="list-style-type: none"> Configurable as always-on 50 mV steps Internally supplied from VSYS
LDO2	VLDO2	0.9 to 3.6	300	2.2 μ F	<ul style="list-style-type: none"> Low noise LDO 50 mV steps
LDO3	VLDO3	0.9 to 3.6	300	2.2 μ F	<ul style="list-style-type: none"> Low noise LDO 50 mV steps Common supply with LDO4
LDO4	VLDO4	0.9 to 3.6	300	2.2 μ F	<ul style="list-style-type: none"> Low noise LDO 50 mV steps Common supply with LDO3

Note 1 For short durations, to meet peak current requirements, I_{OUT} for Buck1 can be operated at up to 20 % higher than the specified maximum operating condition. The part should not be operated in this mode for extended periods and is not guaranteed for continuous operation.

Note 2 For short durations, to meet peak current requirements, I_{OUT} for Buck2 and Buck3 can be operated at up to 10 % higher than the specified maximum operating condition. The part should not be operated in this mode for extended periods and is not guaranteed for continuous operation.

PMIC for Applications Requiring up to 6 A

3 Absolute Maximum Ratings

Table 4 lists the absolute maximum ratings of the device. Exceeding these ratings may cause permanent damage to the device. Device functionality is only guaranteed under the conditions listed in Sections 4 and 5. Operating the device in conditions exceeding those listed in Sections 4 and 5, but compliant with the absolute maximum ratings listed in Table 4, for extended periods of time may affect device reliability.

Table 4: Absolute Maximum Ratings

Parameter	Symbol	Note	Min	Typ	Max	Unit
Storage temperature			-65		+150	°C
Junction temperature	T _J		-40		+150 Note 1	°C
Supply voltage	V _{sys}		-0.3		6.0	V
	V _{BBAT}		-0.3		3.2	V
	Buck V _{DD}		-0.3		V _{sys} + 0.4 Note 2	V
	V _{TP}		-0.3		8.0 Note 3	V
	All other pins		-0.3		V _{sys} + 0.3 Note 2	V
ESD protection HBM	V _{ESD_HBM}		2000			V
ESD protection CDM	V _{ESD_CDM}	Corner pins	750			V
		All other pins	500			

Note 1 See Sections 5.8 and 7.10 for more detail.

Note 2 Voltage must not exceed 5.5 V.

Note 3 Voltage on TP pin should be 0 V except during in-circuit programming.

PMIC for Applications Requiring up to 6 A**4 Recommended Operating Conditions****Table 5: Recommended Operating Conditions**

Parameter	Symbol	Note	Min	Typ	Max	Unit
Operating junction temperature	T_J		-40		+125	°C
Main supply	V_{SYS}		0		5.5	V
Backup supply	V_{BBAT}		0		3.15	V
I/O supply	V_{DDIO}	Note 1	1.2		3.6	V
TP programming supply	V_{TP_PROG}	Note 2	7.25	7.5	7.75	V

Note 1 V_{DDIO} must not exceed V_{SYS} .

Note 2 Voltage on TP pin should be 0 V except during in-circuit programming.

PMIC for Applications Requiring up to 6 A

4.1 Thermal Characteristics

Table 6: QFN Package Ratings

Parameter	Symbol	Note	Typ	Unit
Thermal resistance junction to ambient	$R_{\theta_{JA}}$	Note 1	20.81	°C/W
Thermal resistance junction to Board	$R_{\theta_{JB}}$	Note 1	5.9	°C/W
Thermal resistance junction to case	$R_{\theta_{JC}}$	Note 1	18.72	°C/W
Maximum power dissipation Note 1	P_{DISS}	Derating factor above $T_A = 70\text{ °C}$: 48.05 mW/°C	3120	mW

Note 1 Obtained from package thermal simulation, 76 mm x 114 mm x 1.6 mm (JEDEC), 6-layer board, 70 μm thick copper top/bottom layers, 35 μm thick copper inside layers, 49 x 0.2 mm thermal vias beneath the device, natural convection (still air).

4.1.1 Power Derating Curves

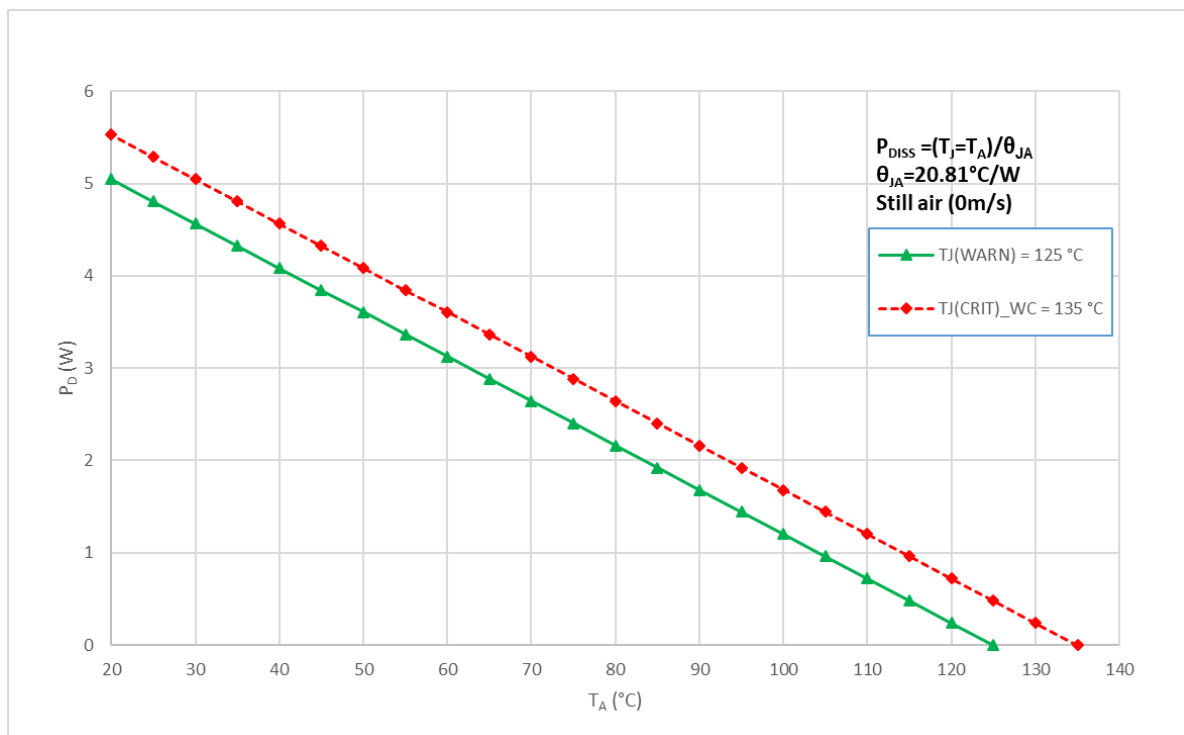

Figure 3: QFN40 Power Derating Curve

Table 7: Typical Temperatures

	$T_A = 70\text{ °C}$	$T_A = 85\text{ °C}$	$T_A = 105\text{ °C}$
T_{WARN}	$P_D = 3.12\text{ W}$	$P_D = 1.92\text{ W}$	$P_D = 0.96\text{ W}$
T_{CRIT}	$P_D = 2.64\text{ W}$	$P_D = 2.40\text{ W}$	$P_D = 1.44\text{ W}$

PMIC for Applications Requiring up to 6 A

5 Electrical Characteristics

5.1 Digital I/O

Unless otherwise noted, the following is valid for $T_J = -40\text{ }^\circ\text{C}$ to $+125\text{ }^\circ\text{C}$, $V_{SYS} = 2.8\text{ V}$ to 5.5 V .

Table 8: Digital I/O Electrical Characteristics

Parameter	Symbol	Test Conditions	Min	Typ	Max	Unit
Input high voltage (GPIO to GPI4, nRESETREQ)	V_{IH}	VDDCORE mode	1.0		V_{SYS}	V
		VDDIO mode	$0.7 * V_{DDIO}$		V_{SYS}	
Input low voltage (GPIO to GPI4, nRESETREQ)	V_{IL}	VDDCORE mode	-0.3		0.4	V
		VDDIO mode $V_{DDIO} \geq 1.5\text{ V}$	-0.3		$0.3 * V_{DDIO}$	
Input high voltage (nONKEY)	V_{IH}		1.0		V_{SYS}	V
Input low voltage (nONKEY)	V_{IL}		-0.3		0.4	V
Input high voltage (SCL, SDA)	V_{IH}	VDDCORE mode	1.0		V_{SYS}	V
		VDDIO mode	$0.7 * V_{DDIO}$		V_{SYS}	
Input low voltage (SCL, SDA)	V_{IL}	VDDCORE mode	-0.3		0.4	V
		VDDIO mode $V_{DDIO} \geq 1.5\text{ V}$	-0.3		$0.3 * V_{DDIO}$	
Output high voltage (GPIO0 to GPIO4, nRESET, nIRQ)	V_{OH}	$I_{OUT} = 1\text{ mA}$ Push-pull mode	$0.7 * V_{DDIO}$			V
Output low voltage (GPIO0 to GPIO4, nRESET, nIRQ)	V_{OL}	$I_{OUT} = 1\text{ mA}$			0.3	V
Output low voltage (SDA)	V_{OL}	$I_{OUT} = 8\text{ mA}$			0.4	V
		$I_{OUT} = 3\text{ mA}$			0.4	
Source current capability (GPIO0 to GPIO4)	I_{OH}	$V_{OUT} = 0.7 * V_{DDIO}$ $V_{DDIO} \geq 1.8\text{ V}$		-1		mA
Sink current capability (GPIO0 to GPIO4)	I_{OL}	$V_{OUT} = 0.3\text{ V}$		1		mA
Input capacitance (SCL, SDA)	C_{IN}				10	pF
Pull-down resistance (GPIO0 to GPIO4)	R_{PD}		50	100	250	k Ω
Pull-up resistance (GPIO0 to GPIO4)	R_{PU}	$V_{DDIO} = 1.5\text{ V}$	60	180	310	k Ω
		$V_{DDIO} = 1.8\text{ V}$	45	120	190	
		$V_{DDIO} = 3.3\text{ V}$	20	40	60	

PMIC for Applications Requiring up to 6 A

5.2 Watchdog

Unless otherwise noted, the following is valid for $T_J = -40\text{ }^\circ\text{C}$ to $+125\text{ }^\circ\text{C}$, $V_{SYS} = 2.8\text{ V}$ to 5.5 V .

Table 9: Watchdog Electrical Characteristics

Parameter	Symbol	Test conditions	Min	Typ	Max	Unit
Minimum watchdog time	t_{WDMIN}	Internal 25 kHz oscillator			200	ms
Maximum watchdog time	t_{WDMAX}	Internal 25 kHz oscillator	2.5			s
Minimum assert time of WDKICK	$t_{WDKICKMIN}$			150		μs

5.3 2-Wire Interface

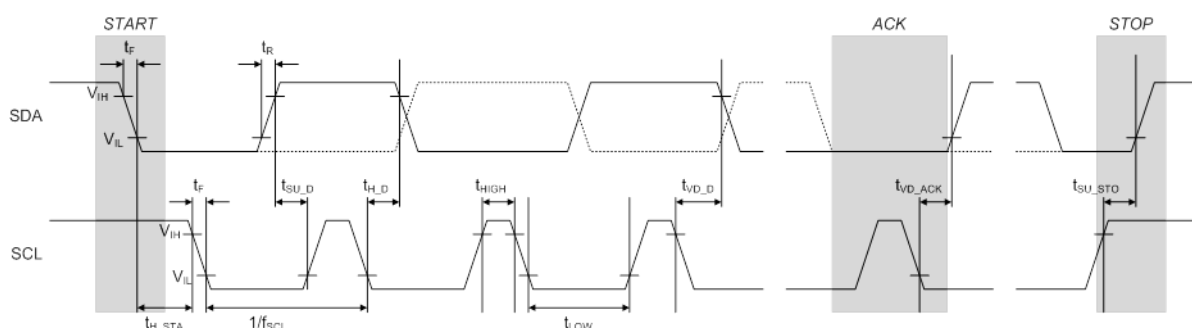

Figure 4: 2-Wire Interface Timing

Unless otherwise noted, the following is valid for $T_J = -40\text{ }^\circ\text{C}$ to $+125\text{ }^\circ\text{C}$, $V_{SYS} = 2.8\text{ V}$ to 5.5 V .

Table 10: 2-Wire Interface Electrical Characteristics

Parameter	Symbol	Test Conditions	Min	Typ	Max	Unit
Bus free time STOP to START	t_{BUF}		0.5			μs
Bus line capacitive load	C_B				150	pF
Standard/Fast/Fast+ Mode						
SCL clock frequency	f_{SCL}	$V_{DDIO} \geq 1.5\text{ V}$ Note 1	0		1.0	MHz
Start condition set-up time	t_{SU_STA}		260			ns
Start condition hold time	t_{H_STA}		260			ns
SCL low time	t_{W_CL}		500			ns
SCL high time	t_{W_CH}		260			ns
2-wire SCL and SDA rise time	t_R	(input requirement)			1000	ns
2-wire SCL and SDA fall time	t_F	(input requirement)			300	ns
Data set-up time	t_{SU_D}		50			ns
Data hold-time	t_{H_D}		0			ns
Data valid time	t_{VD_D}				450	ns
Data valid time acknowledge	t_{VD_ACK}				450	ns

PMIC for Applications Requiring up to 6 A

Parameter	Symbol	Test Conditions	Min	Typ	Max	Unit
Stop condition set-up time	t _{SU_STO}		260			ns
High Speed Mode						
SCL clock frequency	f _{SCL}	V _{DDIO} ≥ 1.8 V Note 1	0		3.4	MHz
Start condition set-up time	t _{SU_STA}		160			ns
Start condition hold time	t _{H_STA}		160			ns
SCL low time	t _{W_CL}		160			ns
SCL high time	t _{W_CH}		60			ns
2-wire SCL and SDA rise time	t _R	(input requirement)			160	ns
2-wire SCL and SDA fall time	t _F	(input requirement)			160	ns
Data set-up time	t _{SU_D}		10			ns
Data hold-time	t _{H_D}		0			ns
Stop condition set-up time	t _{SU_STO}		160			ns

Note 1 Minimum clock frequency is 10 kHz if TWOWIRE_TO is enabled.

PMIC for Applications Requiring up to 6 A

5.4 LDOs

5.4.1 LDO1

Unless otherwise noted, the following is valid for $T_J = -40\text{ °C}$ to $+125\text{ °C}$.

Table 11: LDO1 Electrical Characteristics

Parameter	Symbol	Test Conditions	Min	Typ	Max	Unit
Input voltage	V_{DD}	$V_{DD} = V_{SYS}$ (Internally connected)	2.8		5.5	V
Maximum output current	I_{OUT_MAX}		100			mA
Output voltage	V_{LDO}	Programmable in 50 mV steps	0.9		3.6	V
Output accuracy		$I_{OUT} = I_{OUT_MAX}$ including static line/load regulation	-3%		+3%	
Stabilization capacitor	C_{OUT}	Including voltage and temperature coefficient	-55%	1.0	+35%	μF
Output capacitor ESR	R_{COUT_ESR}	$f > 1\text{ MHz}$ Including wiring parasitics	0		300	$\text{m}\Omega$
Short circuit current	I_{SHORT}			200		mA
Dropout voltage	$V_{DROPOUT}$	$V_{LDO} = 3.3\text{ V}$ $I_{OUT} = I_{OUT_MAX}$		100	150	mV
Static line regulation	V_{S_LINE}	$V_{DD} = 3.0\text{ V}$ to 5.5 V $I_{OUT} = I_{OUT_MAX}$		5	20	mV
Static load regulation	V_{S_LOAD}	$I_{OUT} = 1\text{ mA}$ to I_{OUT_MAX}		5	20	mV
Line transient response	V_{TR_LINE}	$V_{DD} = 3.0\text{ V}$ to 3.6 V $I_{OUT} = I_{OUT_MAX}$ $t_R = t_F = 10\ \mu\text{s}$		5	20	mV
Load transient response	V_{TR_LOAD}	$V_{DD} = 3.6\text{ V}$, $V_{LDO} = 3.3\text{ V}$ $I_{OUT} = 1\text{ mA}$ to I_{OUT_MAX} $t_R = t_F = 1\ \mu\text{s}$		30	50	mV
Power supply rejection ratio	PSRR	$V_{DD} = 3.6\text{ V}$ $V_{DD} - V_{LDO} \geq 0.6\text{ V}$ $I_{OUT} = I_{OUT_MAX}/2$ $f = f_{VDD_LDO}$				
		$f = 10\text{ Hz}$ to 10 kHz	40	60		dB
Output noise	N	$V_{DD} = 3.6\text{ V}$, $V_{LDO} = 2.8\text{ V}$ $I_{OUT} = 5\text{ mA}$ to I_{OUT_MAX} $f = 10\text{ Hz}$ to 100 kHz $T_A = 25\text{ °C}$		70		$\mu\text{V rms}$
Quiescent current in ON mode	I_{Q_ON}	$T_A = 25\text{ °C}$		9 + 0.9% I_{OUT}		μA
Quiescent current in SLEEP mode	I_{Q_SLEEP}	$T_A = 25\text{ °C}$		1.5 + 1.6% I_{OUT}		μA
Quiescent current in OFF mode	I_{Q_OFF}	$V_{LDO} < 0.5\text{ V}$ $T_A = 25\text{ °C}$			1	μA

PMIC for Applications Requiring up to 6 A

Parameter	Symbol	Test Conditions	Min	Typ	Max	Unit
Turn-on time	t _{ON}	10 % to 90 %			350	μs
		SLEEP mode			450	
Turn-off time	t _{OFF}	90 % to 10% Pull-down enabled			1	ms
Pull-down resistance in OFF mode	R _{OFF}	VLDO = 0.5 V Can be disabled via LDO1_PD_DIS		50		Ω

5.4.2 LDO2, LDO3, LDO4

Unless otherwise noted, the following is valid for T_J = -40 °C to +125 °C.

Table 12: LDO2, LDO3, LDO4 Electrical Characteristics

Parameter	Symbol	Test Conditions	Min	Typ	Max	Unit
Input voltage	V _{DD}	V _{DD} = V _{SYS}	2.8		5.5	V
		Supplied from buck converter	1.5			
Maximum output current	I _{OUT_MAX}	V _{DD} ≥ 1.8 V (I _{OUT} = I _{OUT_MAX} /3, V _{DD} < 1.8 V)	300			mA
Output voltage	V _{LDO}	Programmable in 50 mV steps	0.9		3.6	V
Output accuracy		I _{OUT} = I _{OUT_MAX} Including static line/load regulation	-3%		+3%	
Stabilization capacitor	C _{OUT}	Including voltage and temperature coefficient	-55%	2.2	+35%	μF
Output capacitor ESR	R _{COUT_ESR}	f > 1 MHz Including wiring parasitics	0		300	mΩ
Short circuit current	I _{SHORT}			600		mA
Dropout voltage	V _{DROPOUT}	I _{OUT} = I _{OUT_MAX} (V _{DD} < 1.8 V, I _{OUT} = I _{OUT_MAX} /3) Note 1		100	150	mV
Static line regulation	V _{S_LINE}	V _{DD} = 3.0 V to 5.5 V I _{OUT} = I _{OUT_MAX}		5	20	mV
Static load regulation	V _{S_LOAD}	I _{OUT} = 1 mA to I _{OUT_MAX}		5	20	mV
Line transient response	V _{TR_LINE}	V _{DD} = 3.0 V to 3.6 V I _{OUT} = I _{OUT_MAX} t _r = t _f = 10 μs		5	20	mV
Load transient response	V _{TR_LOAD}	V _{DD} = 3.6 V, V _{LDO} = 3.3 V I _{OUT} = 1 mA to I _{OUT_MAX} t _r = t _f = 1 μs		30	50	mV
Power supply rejection ratio	PSRR	V _{DD} = 3.6 V V _{DD} - V _{LDO} ≥ 0.6 V I _{OUT} = I _{OUT_MAX} /2 f = f _{VDD_LDO}				
		f = 10 Hz to 1 kHz f = 1 kHz to 10 kHz f = 10 kHz to 100 kHz	70 60 40	80 70 50		dB

PMIC for Applications Requiring up to 6 A

Parameter	Symbol	Test Conditions	Min	Typ	Max	Unit
Output noise	N	$V_{DD} = 3.6\text{ V}$ $V_{LDO} = 2.8\text{ V}$ $I_{OUT} = 5\text{ mA to } I_{OUT_MAX}$ $f = 10\text{ Hz to } 100\text{ kHz}$		50		$\mu\text{V rms}$
Quiescent current in ON mode	I_{Q_ON}	$T_A = 25\text{ }^\circ\text{C}$		$9 + 0.34\% I_{OUT}$		μA
Quiescent current in SLEEP mode	I_{Q_SLEEP}	$T_A = 25\text{ }^\circ\text{C}$		$2 + 0.7\% I_{OUT}$		μA
Quiescent current in OFF mode	I_{Q_OFF}	$V_{LDO} < 0.5\text{ V}$ $T_A = 25\text{ }^\circ\text{C}$			1	μA
Turn-on time	T_{ON}	10 % to 90 %			200	μs
		SLEEP mode			300	
Turn-off time	T_{OFF}	90 % to 10 % Pull-down enabled			1	ms
Pull-down resistance in OFF mode	R_{OFF}	$V_{LDO} = 0.5\text{ V}$ Can be disabled via $LDO<x>_PD_DIS$		50		Ω

Note 1 At $V_{DD} = 1.8\text{ V}$, the dropout voltage at I_{OUT_MAX} increases by 70%.

5.4.3 LDOCORE

Unless otherwise noted, the following is valid for $T_J = -40\text{ }^\circ\text{C}$ to $+125\text{ }^\circ\text{C}$, $V_{SYS} = 2.8\text{ V}$ to 5.5 V .

Table 13: LDOCORE Electrical Characteristics

Parameter	Symbol	Test Conditions	Min	Typ	Max	Unit
Output voltage	V_{DDCORE}	Note 1	2.45	2.5	2.55	V
		RESET mode		2.2		V
Stabilization capacitor	C_{OUT}	Including voltage and temperature coefficient	-55%	2.2	+35%	μF
Output capacitor ESR	R_{COUT_ESR}	$f > 1\text{ MHz}$ including wiring parasitics	0		300	$\text{m}\Omega$
Dropout voltage	$V_{DROPOUT}$	Note 2		50	100	mV

Note 1 Setting $V_{DD_FAULT_LOWER} \geq 2.65\text{ V}$ avoids LDOCORE dropout, see Section 5.7.

Note 2 The LDOCORE supply, V_{SYS} , must be maintained above $V_{DDCORE} + V_{DROPOUT}$

NOTE

LDOCORE is only used to supply internal circuits.

PMIC for Applications Requiring up to 6 A

5.5 Buck Converters

5.5.1 Buck1

Unless otherwise noted, the following is valid for $T_J = -40\text{ °C}$ to $+125\text{ °C}$.

Table 14: Buck1 Electrical Characteristics

Parameter	Symbol	Test Conditions	Min	Typ	Max	Unit
Input voltage	V_{DD}	$V_{DD} = V_{SYS}$	2.8		5.5	V
Output capacitor	C_{OUT}	Half-current mode including voltage and temperature coefficient	-50%	2 * 22	+30%	μF
		Full-current mode including voltage and temperature coefficient		2 * 47		
Output capacitor ESR	R_{COUT_ESR}	$C_{OUT} = 2 * 22\ \mu\text{F}$ $f > 100\ \text{kHz}$ Including wiring parasitics		15	50	$\text{m}\Omega$
		$C_{OUT} = 2 * 47\ \mu\text{F}$ $f > 100\ \text{kHz}$ Including wiring parasitics		7.5	25	
Inductor value	L_{BUCK}	Including current and temperature dependence	0.7	1.0	1.3	μH
Inductor resistance	R_{L_DCR}			55	100	$\text{m}\Omega$
PWM Mode						
Output voltage	V_{BUCK}	Programmable in 10 mV steps Note 1	0.3		1.57	V
Output voltage accuracy	V_{BUCK_ACC}	$V_{DD} = 4.2\ \text{V}$, $V_{BUCK} = 1.03\ \text{V}$ Excluding static line/load regulation and voltage ripple $T_A = 25\text{ °C}$	-1%		+1%	
		Including static line/load regulation and voltage ripple Note 2	-3%		+3%	
Transient load regulation	V_{TR_LOAD}	$V_{DD} = 3.6\ \text{V}$, $V_{BUCK} = 1.15\ \text{V}$ $I_{OUT} = 200\ \text{mA}$ to $1000\ \text{mA}$ $di/dt = 3\ \text{A}/\mu\text{s}$ $L = 1\ \mu\text{H}$		30	45	mV
Transient line regulation	V_{TR_LINE}	$V_{DD} = 3.0\ \text{V}$ to $3.6\ \text{V}$ $I_{OUT} = 500\ \text{mA}$ $t_R = t_F = 10\ \mu\text{s}$		0.2	3	mV
Output current	I_{OUT}	Half-current mode			1250	mA
		Full-current mode Note 3			2500	
Current limit	I_{LIM}	Half-current mode controlled in BUCK<x>_ILIM in 100 mA steps	700		2200	mA
		Full-current mode controlled in BUCK<x>_ILIM in 200 mA steps	1400		4400	
Current limit accuracy	I_{LIM_ACC}		-20%		20%	

PMIC for Applications Requiring up to 6 A

Parameter	Symbol	Test Conditions	Min	Typ	Max	Unit
Quiescent current in OFF mode	I _{Q_OFF}				1	μA
Quiescent current in PWM mode	I _{Q_ON}	Half-current mode V _{DD} = 3.6 V I _{OUT} = 0 mA T _A = 25 °C		9		mA
		Full-current mode V _{DD} = 3.6 V I _{OUT} = 0 mA T _A = 25 °C		11		
Switching frequency Note 4	f	OSC_FRQ = 0000	2.85	3	3.15	MHz
Switching duty cycle	DC		14%		83%	
Turn-on time	t _{ON}	V _{BUCK} = 1.15 V BUCK_SLOWSTART = disabled SLEW_RATE = 10 mV/1 μs BUCK<x>_ILIM = 1500 mA		0.37	1.2	ms
Output pull-down resistance	R _{PD}	V _{BUCK} = 0.5 V Disabled via BUCK<x>_PD_DIS		100	200	Ω
PMOS ON resistance	R _{PMOS}	Half-current mode Including pin and routing V _{DD} = 3.6 V		160		mΩ
		Full-current mode Including pin and routing V _{DD} = 3.6 V		80		
NMOS ON resistance	R _{NMOS}	Half-current mode Including pin and routing V _{DD} = 3.6 V		60		mΩ
		Full-current mode Including pin and routing V _{DD} = 3.6 V		30		
PFM mode						
Output voltage	V _{BUCK_PFM}	Programmable in 10 mV steps	0.3		1.57	V
Mode transition current threshold (PFM to PWM) in AUTO mode Note 5	I _{AUTO_THR}	V _{DD} = 3.6 V V _{BUCK} = 1.15 V R _{TRACK} ≈ 45 mΩ including bondwire, PCB, and inductor ESR		400		mA
Output current	I _{OUT_PFM}	Forced PFM mode			300	mA
Current limit	I _{LIM_PFM}			1000		mA
Quiescent current	I _{Q_PFM}	Forced PFM mode I _{OUT} = 0 mA		27	32	μA
		AUTO mode I _{OUT} = 0 mA		35	42	
Mode transition time	t _{AUTO}	AUTO mode		6		μs

Note 1 If control BUCK<x>_MODE = 10 (Synchronous) then the buck operates in PFM mode for V_{BUCK} < 0.7 V. For complete control of the buck mode (PWM versus PFM) use BUCK<x>_MODE = 00.

Note 2 Minimum tolerance 35 mV.

Note 3 For short durations, to meet peak current requirements, I_{OUT} for Buck1 can be operated at up to 20 % higher than the specified maximum operating condition. The part should not be operated in this mode for extended periods and is not guaranteed for continuous operation.

PMIC for Applications Requiring up to 6 A

Note 4 Generated from internal 6 MHz oscillator and can be adjusted by $\pm 10\%$ via control OSC_FRQ, see Section 7.12.

Note 5 Auto-mode is not recommended for new designs, see Section 7.7.6.

5.5.2 Buck2

Unless otherwise noted, the following is valid for $T_J = -40\text{ }^\circ\text{C}$ to $+125\text{ }^\circ\text{C}$.

Table 15: Buck2 Electrical Characteristics

Parameter	Symbol	Test Conditions	Min	Typ	Max	Unit
Input voltage	V_{DD}	$V_{DD} = V_{SYS}$ $I_{OUT} \leq 1.5\text{ A}$	2.8		5.5	V
		$V_{DD} = V_{SYS}$ $I_{OUT} > 1.5\text{ A}$	3.3		5.5	
Output capacitor	C_{OUT}	$I_{OUT} \leq 1.5\text{ A}$ Including voltage and temperature coefficient	-50%	$2 * 22$	+30%	μF
		$I_{OUT} > 1.5\text{ A}$ Including voltage and temperature coefficient	-50%	$2 * 47$	+30%	
Output capacitor ESR	R_{COUT_ESR}	$C_{OUT} = 2 * 22\text{ }\mu\text{F}$ $f > 100\text{ kHz}$ Including wiring parasitics		15	50	$\text{m}\Omega$
		$C_{OUT} = 2 * 47\text{ }\mu\text{F}$ $f > 100\text{ kHz}$ Including wiring parasitics		7.5	25	
Inductor value	L_{BUCK}	Including current and temperature dependence	0.7	1.0	1.3	μH
Inductor resistance	R_{L_DCR}			55	100	$\text{m}\Omega$
PWM Mode						
Output voltage	V_{BUCK}	Programmable in 20 mV steps	0.8		3.34 Note 1	V
Output voltage accuracy	V_{BUCK_ACC}	Including static line and load regulation and voltage ripple Note 2	-3%		+3%	
Transient load regulation	V_{TR_LOAD}	$V_{DD} = 3.6\text{ V}$, $V_{BUCK} = 1.8\text{ V}$ $I_{OUT} = 200\text{ mA}$ to 1000 mA $di/dt = 3\text{ A}/\mu\text{s}$ $L = 1\text{ }\mu\text{H}$		30	45	mV
		$V_{DD} = 3.6\text{ V}$, $V_{BUCK} = 1.8\text{ V}$ $I_{OUT} = 200\text{ mA}$ to 2000 mA $di/dt = 3\text{ A}/\mu\text{s}$ $L = 1\text{ }\mu\text{H}$		60	90	
		$V_{DD} = 5.0\text{ V}$, $V_{BUCK} = 3.34\text{ V}$ $I_{OUT} = 200\text{ mA}$ to 2000 mA $di/dt = 3\text{ A}/\mu\text{s}$ $L = 1\text{ }\mu\text{H}$		60	90	
Transient line regulation	V_{TR_LINE}	$V_{DD} = 3.0\text{ V}$ to 3.6 V $I_{OUT} = 500\text{ mA}$ $t_R = t_F = 10\text{ }\mu\text{s}$		0.2	3	mV
Output current	I_{OUT}	$V_{DD} - V_{BUCK} \geq 1.25\text{ V}$ Note 3			2000	mA

PMIC for Applications Requiring up to 6 A

Parameter	Symbol	Test Conditions	Min	Typ	Max	Unit
		$V_{DD} - V_{BUCK} \geq 1.00 \text{ V}$			1250	
		$V_{DD} - V_{BUCK} \geq 0.75 \text{ V}$			900	
Current limit	I_{LIM}	Controlled in BUCK2_ILIM in 100 mA steps	1700		3200	mA
Current limit accuracy	I_{LIM_ACC}		-20%		20%	
Quiescent current in OFF mode	I_{Q_OFF}				1	μA
Quiescent current in PWM mode	I_{Q_ON}	$I_{OUT} = 0 \text{ mA}$ $T_A = 25 \text{ }^\circ\text{C}$		9		mA
Switching frequency Note 4	f	OSC_FRQ = 0000	2.85	3	3.15	MHz
Switching duty cycle	D		15%		90%	
Turn-on time	t_{ON}	$V_{BUCK} = 1.80 \text{ V}$ BUCK_SLOWSTART = disabled SLEW_RATE = 20 mV/2 μs BUCK2_ILIM = 2500 mA		0.44	1.5	ms
Output pull-down resistance	R_{PD}	$V_{BUCK} = 0.5 \text{ V}$ Disabled via BUCK2_PD_DIS		100	200	Ω
PMOS ON resistance	R_{PMOS}	Including pin and routing $V_{DD} = 3.6 \text{ V}$		150		m Ω
NMOS ON resistance	R_{NMOS}	Including pin and routing $V_{DD} = 3.6 \text{ V}$		60		m Ω
PFM mode						
Output voltage	V_{BUCK_PFM}	Programmable in 20 mV steps	0.8		3.34	V
Mode transition current threshold (PFM to PWM) in AUTO mode Note 5	I_{AUTO_THR}	$V_{DD} = 3.6 \text{ V}$ $V_{BUCK} = 1.8 \text{ V}$ $R_{TRACK} \sim 45 \text{ m}\Omega$ Including bondwire, PCB, and inductor ESR		400		mA
Output current	I_{OUT_PFM}	Forced PFM mode			300	mA
Current limit	I_{LIM_PFM}			1000		mA
Quiescent current	I_{Q_PFM}	Forced PFM mode, $I_{OUT} = 0 \text{ mA}$		22	25	μA
		AUTO mode, $I_{OUT} = 0 \text{ mA}$		30	35	
Mode transition time	t_{AUTO}	AUTO mode		6		μs

Note 1 Maximum output is $V_{DD} - 0.7 \text{ V}$

Note 2 Minimum tolerance 35 mV

Note 3 For short durations, to meet peak current requirements, I_{OUT} for Buck2 can be operated at up to 10 % higher than the specified maximum operating condition. The part should not be operated in this mode for extended periods and is not guaranteed for continuous operation.

Note 4 Generated from internal 6 MHz oscillator and can be adjusted by $\pm 10 \%$ via register OSC_FRQ, see Section [7.12](#).

Note 5 Auto-mode is not recommended for new designs, see Section [7.7.6](#).

PMIC for Applications Requiring up to 6 A

5.5.3 Buck3

Unless otherwise noted, the following is valid for $T_J = -40\text{ }^\circ\text{C}$ to $+125\text{ }^\circ\text{C}$.

Table 16: Buck3 Electrical Characteristics

Parameter	Symbol	Test Conditions	Min	Typ	Max	Unit
Input voltage	V_{DD}	$V_{DD} = V_{SYS}$	2.8		5.5	V
Output capacitor	C_{OUT}	Including voltage and temperature coefficient	-50%	2 * 22	+30%	μF
Output capacitor ESR	R_{COUT_ESR}	$f > 100\text{ kHz}$ Including wiring parasitics		15	50	$\text{m}\Omega$
Inductor value	L_{BUCK}	Including current and temperature dependence	0.7	1.0	1.3	μH
Inductor resistance	R_{L_DCR}			55	100	$\text{m}\Omega$
PWM Mode						
Output voltage	V_{BUCK}	Programmable in 10 mV steps Note 1	0.7		1.8	V
Output voltage accuracy	V_{BUCK_ACC}	Including static line/load regulation and voltage ripple Note 2	-3%		+3%	
Transient load regulation	V_{TR_LOAD}	$V_{DD} = 3.6\text{ V}$ $V_{BUCK} = 1.35\text{ V}$ $I_{OUT} = 200\text{ mA}$ to 1000 mA $di/dt = 3\text{ A}/\mu\text{s}$ $L = 1\text{ }\mu\text{H}$		25	40	mV
		$V_{DD} = 3.6\text{ V}$ $V_{BUCK} = 1.35\text{ V}$ $I_{OUT} = 200\text{ mA}$ to 1500 mA $di/dt = 3\text{ A}/\mu\text{s}$ $L = 1\text{ }\mu\text{H}$		40	60	mV
Transient line regulation	V_{TR_LINE}	$V_{DD} = 3.0\text{ V}$ to 3.6 V $I_{OUT} = 500\text{ mA}$ $t_R = t_F = 10\text{ }\mu\text{s}$		0.2	3	mV
Output current	I_{OUT}	$V_{DD} - V_{BUCK} \geq 1.25\text{ V}$ Note 3			1500	mA
		$V_{DD} - V_{BUCK} \geq 1.00\text{ V}$			1250	
Current limit	I_{LIM}	Controlled in BUCK3_ILIM in 100 mA steps	700		2200	mA
Current limit accuracy	I_{LIM_ACC}	$I_{LIM} = 700\text{ mA}$ to 1400 mA	-15		+25	%
		$I_{LIM} = 1400\text{ mA}$ to 2200 mA	-10		+15	
Quiescent current in OFF mode	I_{Q_OFF}				1	μA
Quiescent current in PWM mode	I_{Q_ON}	$I_{OUT} = 0\text{ mA}$ $T_A = 25\text{ }^\circ\text{C}$		9		mA
Switching frequency Note 4	f	OSC_FRQ = 0000	2.85	3	3.15	MHz

PMIC for Applications Requiring up to 6 A

Parameter	Symbol	Test Conditions	Min	Typ	Max	Unit
Switching duty cycle	D		14		83	%
Turn-on time	t _{ON}	V _{BUCK} = 1.35 V BUCK_SLOWSTART = disabled SLEW_RATE = 10 mV/1 μs BUCK3_ILIM = 1500 mA		0.39	1.2	ms
Output pull-down resistance	R _{PD}	V _{BUCK} = 0.5 V Disabled via BUCK3_PD_DIS		100	200	Ω
PMOS ON resistance	R _{PMOS}	Including pin and routing V _{DD} = 3.6 V		150		mΩ
NMOS ON resistance	R _{NMOS}	Including pin and routing V _{DD} = 3.6 V		60		mΩ
PFM mode						
Output voltage	V _{BUCK_PFM}	Programmable in 10 mV steps.	0.53		1.8	V
Mode transition current threshold (PFM to PWM) in AUTO mode Note 5	I _{AUTO_THR}	V _{DD} = 3.6 V V _{BUCK} = 1.35 V R _{TRACK} ≈ 45 mΩ Including bondwire, PCB, inductor ESR		400		mA
Output current	I _{OUT_PFM}				300	mA
Current limit	I _{LIM_PFM}			1000		mA
Quiescent current	I _{Q_PFM}	Forced PFM mode I _{OUT} = 0 mA		22	25	μA
		AUTO mode I _{OUT} = 0 mA		30	35	
Mode transition time	t _{AUTO}	AUTO mode		6		μs

Note 1 If register BUCK3_MODE = 10 (synchronous) then the buck operates in PFM mode for V_{BUCK} < 0.7 V. For complete control of the buck mode (PWM versus PFM) use BUCK3_MODE = 00.

Note 2 Minimum tolerance 35 mV.

Note 3 For short durations, to meet peak current requirements, I_{OUT} for Buck3 can be operated at up to 10 % higher than the specified maximum operating condition. The part should not be operated in this mode for extended periods and is not guaranteed for continuous operation.

Note 4 Generated from internal 6 MHz oscillator and can be adjusted by ±10% via control OSC_FRQ, see Section [7.12](#).

Note 5 Auto-mode is not recommended for new designs, see Section [7.7.6](#).

5.6 Internal Oscillator

Unless otherwise noted, the following is valid for T_J = -40 °C to +125 °C, V_{SYS} = 2.8 V to 5.5 V.

Table 17: Internal Oscillator Electrical Characteristics

Parameter	Symbol	Test conditions	Min	Typ	Max	Unit
Oscillator frequency	f _{OSC}	OSC_FRQ = 0000	5.7	6	6.3	MHz

Note 1 Oscillator frequency can be further adjusted by about ±10%, see Section [7.12](#).

PMIC for Applications Requiring up to 6 A

5.7 System Supply Voltage Supervision

Unless otherwise noted, the following is valid for $T_J = -40\text{ }^\circ\text{C}$ to $+125\text{ }^\circ\text{C}$, $V_{\text{SYS}} = 2.8\text{ V}$ to 5.5 V .

Table 18: System Supply Voltage Supervision Electrical Characteristics

Parameter	Symbol	Test Conditions	Min	Typ	Max	Unit
Under-voltage lockout lower threshold	$V_{\text{POR_LOWER}}$			2.0		V
Under-voltage lockout upper threshold	$V_{\text{POR_UPPER}}$			2.3		V
V_{SYS} under-voltage lower threshold	$V_{\text{DD_FAULT_LOWER}}$ Note 1		2.5	2.8	3.25	V
V_{SYS} under-voltage lower threshold accuracy	$V_{\text{SYS_LOWER}}$		-2%		+2%	
V_{SYS} hysteresis	$V_{\text{DD_FAULT_HYS}}$ Note 2		100	200	450	mV
V_{SYS} upper threshold	$V_{\text{DD_FAULT_UPPER}}$		-2%	$V_{\text{DD_FAULT_LOWER}} + V_{\text{DD_FAULT_HYS}}$	+2%	
Reference voltage	V_{REF}		-1%	1.2	+1%	V
V_{REF} decoupling capacitor	C_{VREF}			2.2		μF
Reference current resistor	R_{IREF}		-1%	200	+1%	k Ω

Note 1 Can be set in 50 mV steps via control $V_{\text{DD_FAULT_ADJ}}$ in register CONFIG_B , setting $V_{\text{DD_FAULT_LOWER}} \geq 2.65\text{ V}$ avoids LDOCORE dropout, see Section 5.4.3.

Note 2 Can be set in 50 mV steps via control $V_{\text{DD_HYST_ADJ}}$ in register CONFIG_B .

5.8 Junction Temperature Supervision

Unless otherwise noted, the following is valid for $T_J = -40\text{ }^\circ\text{C}$ to $+125\text{ }^\circ\text{C}$, $V_{\text{SYS}} = 2.8\text{ V}$ to 5.5 V .

Table 19: Junction Temperature Supervision Electrical Characteristics

Parameter	Symbol	Test Conditions	Min	Typ	Max	Unit
POR temperature threshold Note 1	T_{POR}	Note 2	145	150	155	$^\circ\text{C}$
Critical temperature threshold Note 1	T_{CRIT}	Note 2	135	140	145	$^\circ\text{C}$
Warning temperature threshold Note 1	T_{WARN}	Note 2	120	125	130	$^\circ\text{C}$

Note 1 See section 7.10.

Note 2 Thermal thresholds are non-overlapping.

PMIC for Applications Requiring up to 6 A**5.9 Current Consumption**

Unless otherwise noted, the following is valid for $T_J = -40\text{ }^\circ\text{C}$ to $+125\text{ }^\circ\text{C}$, $V_{SYS} = 2.8\text{ V}$ to 5.5 V .

Table 20: Current Consumption Electrical Characteristics

Operating mode	Symbol	Test Conditions	V_{SYS} (Typ)	Unit
POWERDOWN mode	I_{DDPD}	$V_{SYS} > 3.0\text{ V}$ LDOCORE enabled Bucks and LDOs disabled	40	μA
ACTIVE mode	I_{DDACT}	Bucks and LDOs enabled	400	μA

6 Typical Characteristics

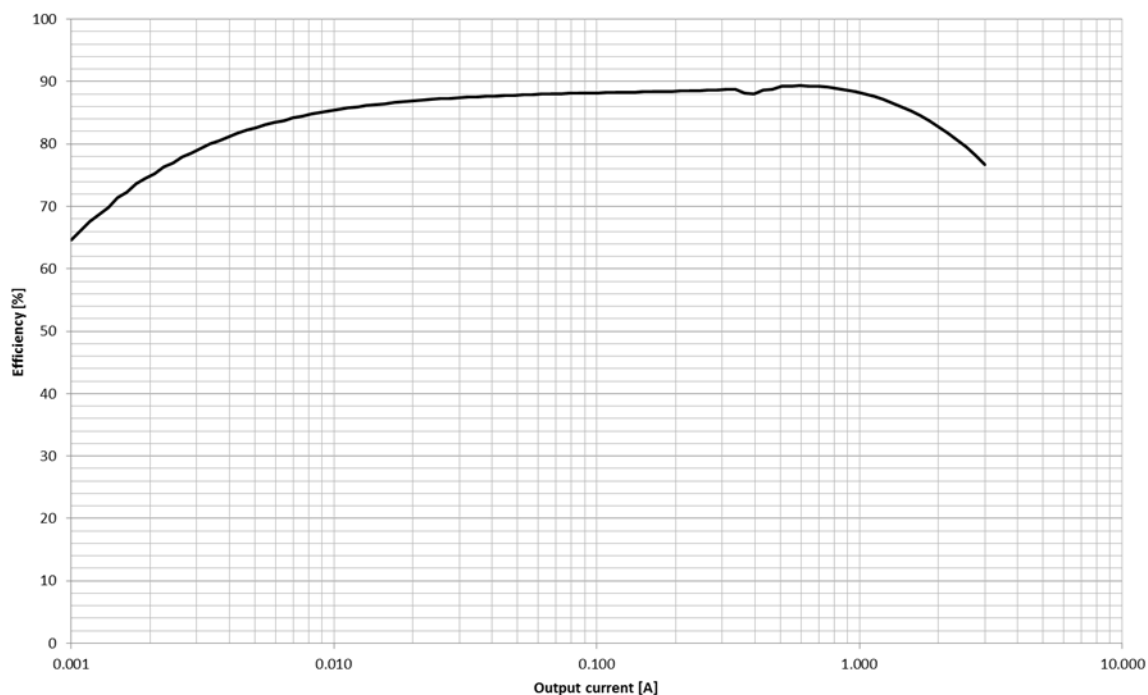

Figure 5: Buck1 Efficiency in AUTO Mode ($V_{IN} = 3.60\text{ V}$, $V_{OUT} = 1.15\text{ V}$)

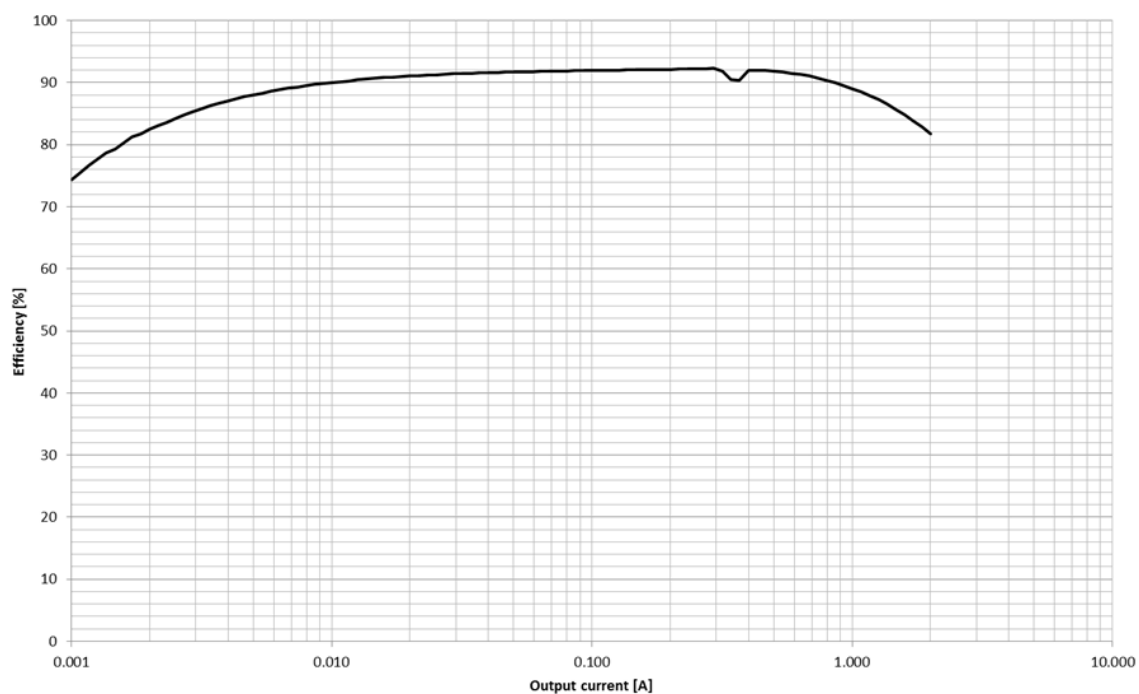

Figure 6: Buck2 Efficiency in AUTO Mode ($V_{IN} = 3.60\text{ V}$, $V_{OUT} = 1.80\text{ V}$)

PMIC for Applications Requiring up to 6 A

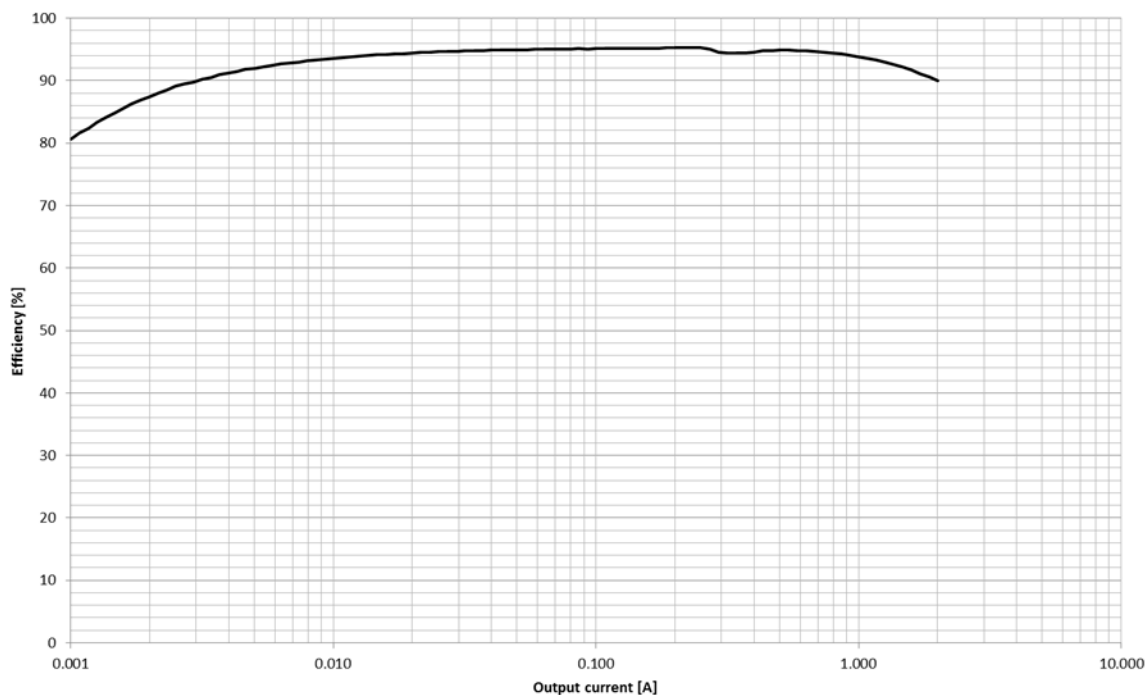

Figure 7: Buck2 Efficiency in AUTO Mode ($V_{IN} = 5.00\text{ V}$, $V_{OUT} = 3.34\text{ V}$)

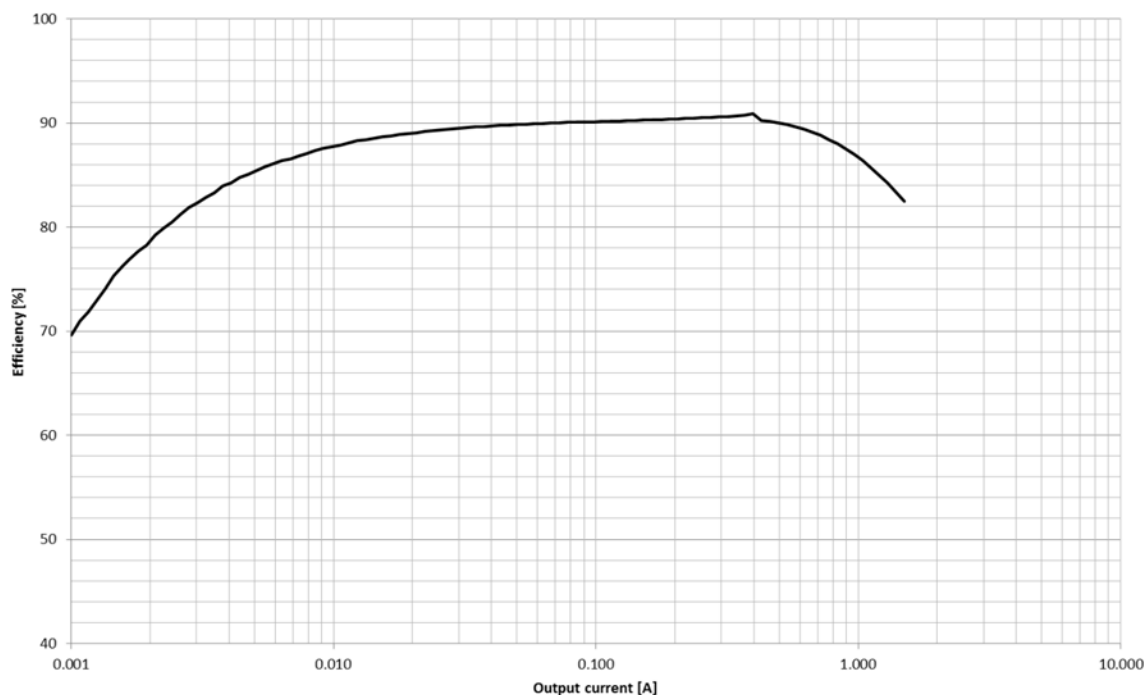

Figure 8: Buck3 Efficiency in AUTO Mode ($V_{IN} = 3.60\text{ V}$, $V_{OUT} = 1.35\text{ V}$)

PMIC for Applications Requiring up to 6 A

7 Functional Description

7.1 Control Signals

Each of the input signals described below feature a debounce filter. They share a common debounce time control (DEBOUNCING).

7.1.1 nONKEY

nONKEY is an edge-sensitive signal that controls the power mode of DA9061. Both falling and rising edges are detected and the time between the edges is measured. This enables different lengths of key press detection. The detection circuitry is enabled in all power modes of the device.

The status of the signal after debouncing can be read from NONKEY (reg. STATUS_A). The mask bit M_NONKEY prevents interrupt and wakeup events that would normally be caused by an nONKEY event.

nONKEY has four modes of operation, see [Table 21](#), which can be selected by NONKEY_PIN. NONKEY_LOCK controls the wakeup event generation of the nONKEY. If NONKEY_LOCK is asserted (depends on NONKEY_PIN), a short nONKEY press (shorter than KEY_DELAY) will not generate a wakeup.

Table 21: nONKEY Functions

nONKEY_PIN	Function
00	An event (E_nONKEY) is generated when nONKEY is asserted. If not masked, the event causes an interrupt. A wakeup is triggered if the device is in POWERDOWN mode.
01	A timer is started when nONKEY is asserted. If the signal is de-asserted before the time programmed in KEY_DELAY, an event (E_nONKEY) is generated at the rising edge. If the signal stays asserted and the timer reaches the programmed value, an event is generated and nONKEY_LOCK is asserted.
10	A timer is started when nONKEY is asserted. If the signal is de-asserted before the time programmed in KEY_DELAY, an event (E_nONKEY) is generated at the rising edge. If the signal stays asserted and the timer reaches the programmed value, an event is generated, nONKEY_LOCK is asserted, and a power-down sequence is triggered by automatically clearing SYSTEM_EN.
11	A timer is started when nONKEY is asserted. If the signal is de-asserted before the time programmed in KEY_DELAY, an event (E_nONKEY) is generated at the rising edge, SYSTEM_EN is cleared, and STANDBY is asserted. If the signal stays asserted and the timer reaches the programmed value, an event is generated, nONKEY_LOCK is asserted, and SYSTEM_EN and STANDBY are cleared.

Whenever nONKEY_LOCK is asserted, a long key press (longer than the time programmed in KEY_DELAY) is required to wakeup from POWERDOWN mode. If the wakeup is also desired after a short key press, nONKEY_LOCK has to be cleared before entering the POWERDOWN mode.

7.1.2 nRESETREQ

nRESETREQ is an active-low reset request that causes DA9061 to enter RESET mode. The transition to the RESET mode is handled by the power sequencer and it can be sped up by setting the HOST_SD_MODE bit. Before entering the RESET mode, a fault log bit is set (nRESETREQ) and nRESET is asserted.

nRESETREQ should be tied to an always-on rail that is supplied in all modes of the DA9061 such as VSYS. It is not recommended to tie nRESETREQ to any of the regulator outputs.

PMIC for Applications Requiring up to 6 A

7.1.3 nRESET

nRESET is an active-low reset output intended for resetting the host processor of the system. The signal can be configured as either push-pull or open drain output (PM_O_TYPE).

nRESET is always asserted upon a cold boot from the no-power mode. It is always asserted at the beginning of a shutdown sequence to the RESET mode. nRESET may also be asserted at the beginning of the sequence to the POWERDOWN mode, if configured in control NRES_MODE.

De-assertion of nRESET is controlled by a reset timer. After being asserted, nRESET remains low until the reset timer, which was started from the selected trigger signal, expires. The reset timer trigger can be selected via RESET_EVENT and set to one of the following: an external signal triggering the wakeup (EXT_WAKEUP), an internal signal indicating the end of the first power-up sub-sequence (SYS_UP), an internal signal indicating the end of the second power-up sub-sequence (PWR_UP), or the transition of DA9061 from reset to POWERDOWN mode. The expiry time can be configured via RESET_TIMER from 1 ms to 1 s. If RESET_TIMER is set to 0 ms, nRESET is de-asserted immediately after the trigger selected with RESET_EVENT.

7.1.4 nIRQ

nIRQ is a level-sensitive interrupt signal. It can be configured either as a push-pull or an open drain output (selected via PM_O_TYPE). The polarity of nIRQ can be selected with IRQ_TYPE.

nIRQ is asserted when an unmasked event has occurred. The nIRQ will not be released until all event registers have been cleared. New events that occur while reading an event register are saved until the event register is cleared, ensuring that the host processor captures them. The same will happen to all events occurring when the power sequencer is in transition.

7.2 2-Wire Interface

The 2-wire interface provides access to the control and status registers. The interface supports operations compatible to the standard, fast, fast-plus, and high-speed modes of the I²C bus specification Rev. 3. Communication on the 2-wire bus is always between two devices; one acting as the master and the other as the slave. The DA9061 only operates as a slave. The default address is 0xB0, this is configurable via OTP, see IF_BASE_ADDR. I²C addresses are stated as 8-bit addresses including R/W bit; for example, 0xB0 is the 8-bit address equivalent to the 7-bit address 0x58 plus the R/W bit = 0 (Write).

SCL transmits 2-wire clock data and SDA transmits the bidirectional data. The 2-wire interface is open-drain supporting multiple devices on one line. The bus lines have to be pulled high by an external pull-up resistor (2 kΩ to 20 kΩ). The attached devices drive the bus lines low by connecting them to ground. As a result, two devices can drive the bus simultaneously without conflict. In standard/fast mode the highest frequency of the bus is 400 kHz. The exact frequency can be determined by the application and it does not have any relation to the DA9061 internal clock signals. DA9061 stays within the described host clock speed limitations and does not initiate clock slow-down. An automatic interface reset is triggered when the clock signal ceases toggling for >35 ms (controlled in TWOWIRE_TO).

When the SDA is stuck, the bus clears after receiving nine clock pulses. Operation in high-speed mode at 3.4 MHz requires a minimum interface supply voltage of 1.8 V and a mode change in order to enable slope-control. The high-speed mode can be enabled on a transfer-by-transfer basis by sending the master code (0000 1XXX) at the beginning of the transfer. The DA9061 does not make use of clock stretching and delivers read data without delay up to 3.4 MHz.

Alternatively, the interface can be configured to use high-speed mode continuously via PM_IF_HSM, so that the master code is not required at the beginning of every transfer. This reduces communication overhead on the bus and limits the attachable bus slaves to compatible devices.

PMIC for Applications Requiring up to 6 A

7.2.1 Register Map Paging

The 2-wire interface has direct access to two pages of the DA9061 register map (up to 256 addresses). The register at address zero on each page is used as a page control register (the LSB of control PAGE is ignored). Writing to the page control register changes the active page for all subsequent read/write operations unless an automatic return to page 0 is selected using control REVERT. Unless REVERT was asserted after modifying the active page, it is recommended to read back the page control register to ensure that future data exchange is accessing the intended registers.

DA9061 also offers an alternative way to access register pages which avoids writing explicitly to PAGE. DA9061 responds to multiple consecutive slave addresses and updates PAGE automatically based on the slave address. For example, when IF_BASE_ADDR[7:4] = 0xB the slave address changes PAGE as follows:

Slave address = 0xB0 ⇒ PAGE = 0x00

Slave address = 0xB2 ⇒ PAGE = 0x02

7.2.2 Details of the 2-Wire Protocol

All data is transmitted across the 2-wire bus in 8-bit groups. To send a bit, the SDA line is driven at the intended state while the SCL is low. Once the SDA has settled, the SCL line is brought high and then low. This pulse on SCL stores the SDA bit in the receiver's shift register.

A 2-byte serial protocol is used: one address byte and one data byte. Data and address transfer transmits the MSB first for both read and write operations. All transmissions begin with the START condition from the master during which the bus is in IDLE state (the bus is free). It is initiated by a high-to-low transition on the SDA line while the SCL is in high state. A STOP condition is indicated by a low-to-high transition on the SDA line while the SCL is in high state. The START and STOP conditions are illustrated in [Figure 9](#).

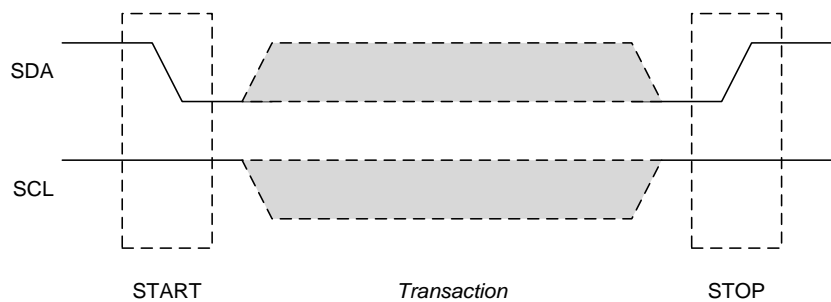

Figure 9: Timing of the START and STOP Conditions

DA9061 monitors the 2-wire bus for a valid slave address whenever the interface is enabled. It responds immediately when it receives its own slave address. This is acknowledged by pulling the SDA line low during the following clock cycle (white blocks marked with A in the following figures).

The protocol for a register write from master to slave consists of a START condition, a slave address, a read/write-bit, 8-bit address, 8-bit data, and a STOP condition. DA9061 responds to all bytes with an ACK. A register write operation is illustrated in [Figure 10](#).

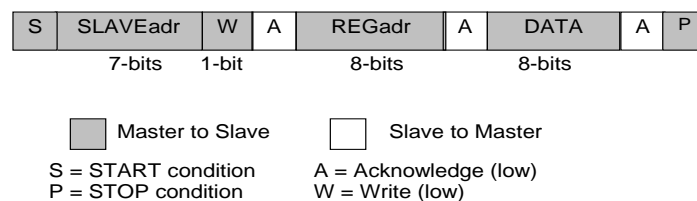

Figure 10: Byte Write Operation

PMIC for Applications Requiring up to 6 A

When the host reads register data the DA9061 first has to access the target register address with write access and then with read access and a repeated START, or alternatively a second START, condition. After receiving the data, the host sends NACK and terminates the transmission with a STOP condition, see [Figure 11](#).

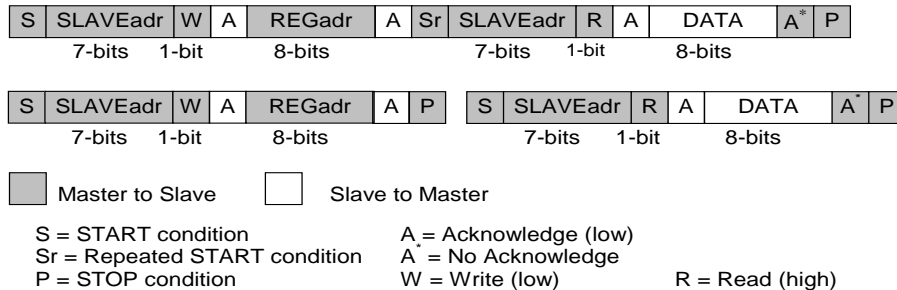

Figure 11: Examples of Byte Read Operations

Consecutive (page) read-out mode is initiated from the master by sending an ACK instead of NACK after receiving a byte, see [Figure 12](#). The 2-wire control block then increments the address pointer to the next register address and sends the data to the master. The data bytes are read continuously until the master sends a NACK followed by a subsequent STOP condition directly after receiving the data. If a non-existent 2-wire address is read out then the DA9061 will return code zero.

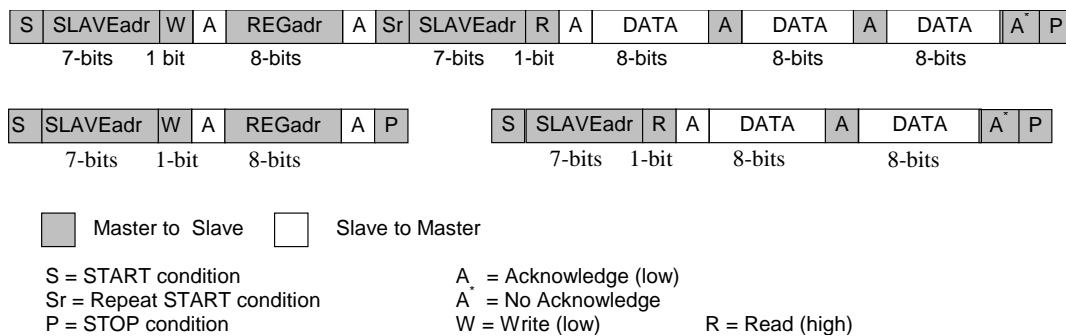

Figure 12: 2-Wire Page Read

The slave address after the repeated START condition must be the same as the previous slave address.

Consecutive (page) write mode is supported if the master sends several data bytes after sending the register address. The 2-wire control block then increments the address pointer to the next 2-wire address, stores the received data, and sends an ACK until the master sends a STOP condition. The page write mode is illustrated in [Figure 13](#).

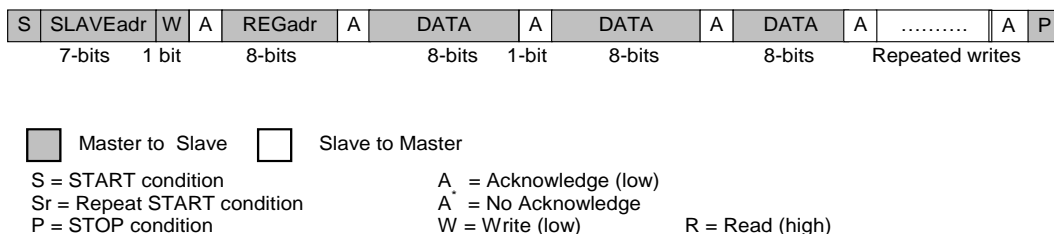

Figure 13: 2-Wire Page Write

PMIC for Applications Requiring up to 6 A

Table 22: GPIO Functions

GPIO<x>_PIN	Function	GPIO<x>_MODE	GPIO<x>_TYPE	GPIO<x>_WKUP_MODE	GPIO<x>_WEN
0	Alternate function	No effect	No effect	No effect	No effect
1	GPI	0: Debounce off 1: Debounce on	0: Active low 1: Active high	0: Edge-sensitive wakeup 1: Level-sensitive wakeup	0: Wakeup disabled 1: Wakeup enabled
2	GPO Open drain	0: Output low 1: Output high	No effect	No effect	No effect
3	GPO Push-pull	0: Output low 1: Output high	No effect	No effect	No effect

7.3.1 GPI Functionality

When configured as a GPI, the polarity of the input can be selected with GPIO<x>_TYPE. A debouncing filter can be applied on the input signals with a configurable debouncing time (control DEBOUNCING). An event is generated at the active edge of the input. The active edge is determined by the signal polarity configured in GPIO<x>_TYPE. The event can be further configured to generate a wakeup via GPIO<x>_WKUP_MODE and GPIO<x>_WEN. An internal pull-down can be activated for the inputs in GPIO<x>_PUPD.

A level sensitive wakeup event can also be configured for each GPI via GPIO<x>_WKUP_MODE and GPIO<x>_WEN. The functionality of the level-sensitive wakeup is described in [Table 25](#).

7.3.1.1 Regulator Control

GPIO1, GPIO2, and GPIO3 can be used for controlling DA9061 regulators. When configured as GPIs, they can be used to enable regulators or select between their two output voltage settings.

As seen in [Figure 15](#), the regulator control is branched after the GPIO<x>_TYPE control allowing active edge delegation for the regulator control. Finally, the functionality for the GPI is selected with the regulator controls BUCK<x>_GPI, LDO<x>_GPI, VBUCK<x>_GPI, and VLDO<x>_GPI.

One GPI can be used to control the same function on multiple regulators simultaneously. When a regulator is controlled by a GPI, the same function (on/off or voltage selection) can no longer be controlled by the power supply sequencer. The regulator still responds normally to register writes to the control bit.

Enable/Disable Control

A GPI is used for enabling/disabling regulators when it is selected in one of the BUCK<x>_GPI or LDO<x>_GPI controls. A passive to active transition sets the regulator enable bit (BUCK<x>_EN, LDO<x>_EN), and an active to passive transition clears it.

Output Voltage Control

A GPI is used for the output voltage selection when it is selected in one of the VBUCK<x>_GPI or VLDO<x>_GPI controls. A passive to active transition sets the voltage selection bit (VBUCK<x>_SEL, VLDO<x>_SEL), and an active to passive edge clears it.

7.3.1.2 Sequencer WAIT_STEP

GPIO3 can be used for the WAIT_STEP functionality. The power sequencer can be programmed to wait for either a rising or falling edge of the WAIT_STEP input, see [Section 7.9.5](#). The active edge is selected from GPIO<x>_TYPE.

PMIC for Applications Requiring up to 6 A

7.3.2 GPO Functionality

The outputs can be configured as push-pull or open drain outputs, see [Table 22](#). An internal pull-up can be enabled/disabled from GPIO<x>_PUPD (open drain mode). The GPIO<x>_MODE settings can control the output state.

Instead of controlling the output with GPIO<x>_MODE, a selection of alternatives is available in the GPIO<x>_OUT controls. These include: the forwarding function, see [Section 7.3.4](#), the power supply sequencer, see [Section 7.9](#), and the status of the supply voltage supervision (nVDD_FAULT). When the GPIO is configured as an output and GPIO<x>_OUT is set to 0x0, the GPIO<x>_MODE determines the state of the output.

7.3.2.1 nVDD_FAULT

nVDD_FAULT gives the status of the system supply monitoring, see [Section 7.11](#). The assertion of nVDD_FAULT indicates that the main supply input voltage has been low ($V_{SYS} < V_{DD_FAULT_LOWER}$) for more than 100 ms and informs the host processor that the power will shut down. It can be configured to drive a GPO from the GPIO<x>_OUT controls. The driver type (push-pull, open-drain) selection and pull-up resistor control function normally. The GPIO<x>_MODE can be used to invert the incoming nVDD_FAULT signal.

7.3.3 Alternate Functions

GPIO0, GPIO2, and GPIO4 can be used for alternate functions. These are digital control signals that do not employ the debouncing, event detection, or interrupt generation functions. Only the input buffer of the GPIO block is employed. The alternate functions of DA9061 are listed in [Table 23](#) and described in the following subsections. A debouncing filter can be applied also on the alternate functions with a configurable debouncing time (register DEBOUNCING).

Table 23: GPIO Alternate Input Functions

GPIO	Alternate Function	Description
GPIO0	WDKICK	Watchdog kick or disable
GPIO1	-	
GPIO2	PWR_EN	Power mode control
GPIO3	-	
GPIO4	SYS_EN	Power mode control

7.3.3.1 SYS_EN

SYS_EN (pin GPIO4) controls the SYSTEM_EN bit and thereby the power mode of DA9061. It is part of the power supply sequencer functionality described in [Section 7.9](#). SYS_EN is an edge-sensitive signal and its polarity can be chosen in the GPIO4_TYPE control.

Asserting SYS_EN causes an interrupt (E_GPIx) and a wakeup event. De-asserting SYS_EN triggers a power-down sequence but no interrupt.

PMIC for Applications Requiring up to 6 A

7.3.3.2 PWR_EN

PWR_EN (pin GPIO2) controls the POWER_EN bit and thereby the power mode of DA9061. It is part of the power supply sequencer functionality described in Section 7.9. PWR_EN is an edge-sensitive signal and its polarity can be chosen in the GPIO2_TYPE control. A wakeup event can be generated after assertion of PWR_EN if so configured in GPIO2_WEN.

7.3.3.3 WDKICK

A rising edge of the WDKICK signal resets the watchdog counter. The polarity of the signal can be chosen in the GPIO0_TYPE control. If the signal is kept asserted, the watchdog is disabled as the counter is not incremented (WDG_MODE), see Section 7.13.

7.3.4 GPIO Forwarding

GPIO forwarding works between GPIOs 0, 1, 2, and 3. Any of these GPIOs can be routed directly to GPIO0, 1, and 3 after debouncing. Forwarding is one of the options for the GPIO<x>_OUT control.

7.4 Dynamic Voltage Control

All of DA9061's buck converters can be controlled in several ways to achieve Dynamic Voltage Control (DVC). The buck converters feature a voltage ramping feature that enables smooth transition from one voltage setting to another.

All output voltages can be controlled with software via the 2-wire interface (VBUCK<x>_A). The 2-wire interface is operational when the device is in ACTIVE mode.

7.5 Regulator Voltage A and B Selection

In addition, all regulators feature A and B settings which can be programmed with different voltages (VBUCK<x>_A, VBUCK<x>_B), one of which is chosen according to the operating mode of the system (VBUCK<x>_SEL, VLDO<x>_SEL). In addition to the output voltage, the A and B settings include a bit to force the regulator into SLEEP mode which reduces the quiescent current.

The selection between the A and B settings can be done either with software via the 2-wire interface or by the power sequencer, see Section 7.9. Furthermore, each regulator can be enabled with a GPI pin, see Section 7.3.1.1, and the selection between the A and B settings done with another GPI.

PMIC for Applications Requiring up to 6 A

7.7 Switching Regulators

DA9061 includes four step-down switching regulators operating at 3 MHz. All switching regulators employ a synchronous topology with an internal NFET, thus eliminating the need for an external Schottky diode. The output voltage can be set in 10 mV steps (20 mV steps for Buck2) and the regulation accuracy is $\pm 3\%$ over the whole operating temperature range. Static line and load regulation are also considered in this accuracy.

The switching frequency (3 MHz) is high enough to warrant the use of a small 1.0 μH inductor. The programming of the converter current limit depends on the coil parameters, as illustrated in [Table 24](#).

Table 24: Buck Current Limit

Min. ISAT (mA)	Frequency (MHz)	Buck Current Limit (mA)
1750	3	1500
1460	3	1200
1180	3	950
940	3	750

7.7.1 Control

The buck can be enabled manually by writing directly to a control register, with an external signal connected to GPI, see [Section 7.3.1.1](#), or by assigning it to a power sequencer step, see [Section 7.9.3](#). Each buck converter features two voltage control registers (VBUCK<x>_A/VBUCK<x>_B) which can be programmed with two different voltages. The active setting can then be selected via a control bit (VBUCK<x>_SEL), via a GPI, see [Section 7.3.1.1](#), or automatically based on the power mode of DA9061.

7.7.2 Output Voltage Slewing

To limit in-rush current from the input supply, the buck converters can achieve a new output voltage with controlled ramping. Ramping is achieved by stepping through all the VBUCK values between the old and new settings, at a rate defined by SLEW_RATE. The actual output slew rate, in $\text{mV}/\mu\text{s}$, for a particular buck converter is then defined by the minimum voltage step of that buck and the common step time programmed in SLEW_RATE. During PFM mode, the negative slew rate is load dependent and might be lower than the one mentioned above. An event E_DVC_RDY is triggered when all buck converters have reached their target voltage.

7.7.3 Soft-Start

The buck converter supports two options for starting up. The normal start-up option ramps up the power rail as fast as possible, typically within 1 ms. This implies a high in-rush current. The slow start-up is selected by setting BUCK_SLOWSTART, which increases the start-up time and limits the input current.

7.7.4 Active Discharge

When switching off a buck converter the output rail can be actively discharged. This feature is enabled by setting BUCK_ACTV_DISCHRG. The discharge is implemented by ramping down the output voltage using DVC.

7.7.5 Peak Current Limit

All buck converters feature a programmable current limit (BUCK<x>_ILIM). The current limit protects the inductor and the pass devices from excessive current. If the current limit is exceeded, the buck continues to run normally but the duty cycle is limited.

PMIC for Applications Requiring up to 6 A

7.7.6 Operating Mode

The operating mode of each converter can be set via the buck control (BUCK<x>_MODE) to synchronous (PWM), sleep (PFM), or auto. In auto mode the buck converter switches between PWM and PFM depending on the load current. The current consumption during PWM operation is 10 mA and drops to <math><1 \mu\text{A}</math> in shutdown.

Note
It is not recommended that the Auto mode transition feature is used under certain operating conditions. Customers wishing to use the Auto mode transition feature should first check with their Dialog FAE.

In addition, the buck mode can be controlled with the A and B setting. If BUCK<x>_SL_B is set, the buck is forced to SLEEP mode when the B setting is active. Similarly, if BUCK<x>_SL_A is set, the buck is forced to SLEEP mode when the A setting is active.

7.7.7 Half-Current Mode

Buck1 can operate in half-current mode where the quiescent current is reduced by disabling half of the pass devices. As the name implies, enabling this option halves the output current, and therefore, this feature is valuable in applications where quiescent current is critical and full current is not needed. This feature is controlled with BUCK1_FCM. If the bit is asserted (BUCK1_FCM = 1), the buck is in full-current mode and the full current is available. If the bit is de-asserted, the buck is in half-current mode. Operating the buck in full-current mode requires twice as much output capacitance (2 x 47 μF) as the half-current mode (2 x 22 μF).

PMIC for Applications Requiring up to 6 A

7.8 Power Modes

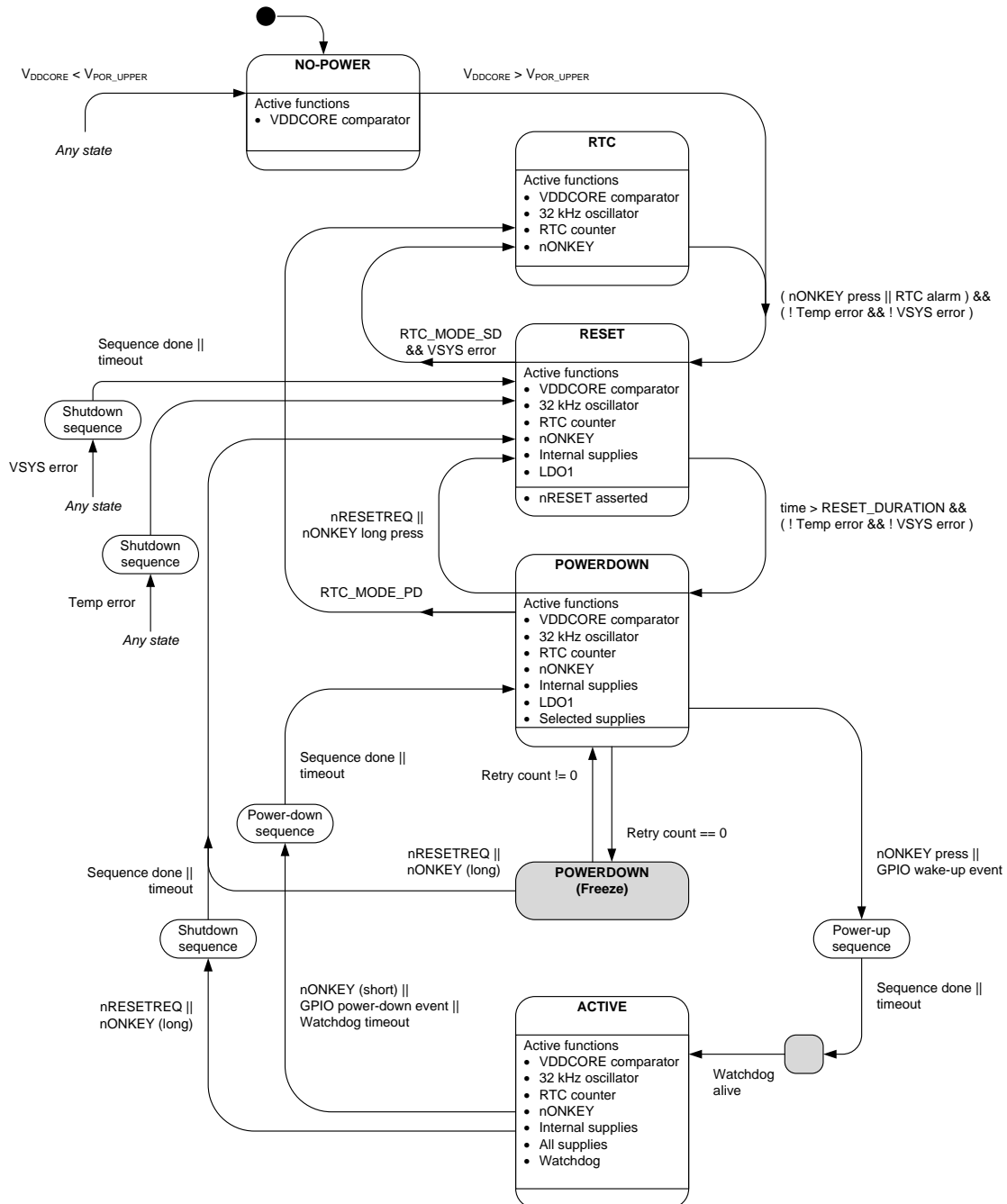

Figure 17: DA9061 Power Modes (State Transition Conditions Follow C-Language Syntax)

7.8.1 NO-POWER Mode

The NO-POWER mode is initial state when powering up the DA9061 for the first time. When the system supply rises above a threshold, DA9061 enters RESET mode.

PMIC for Applications Requiring up to 6 A

7.8.2 RESET Mode

In RESET mode, the internal supplies, and LDO1 (if configured as an always-on supply) are enabled. All other DA9061 supplies are disabled.

DA9061 is in RESET mode whenever a complete application shutdown is required. RESET mode can be triggered by the user, a host processor, or an internal event.

RESET mode can be triggered by the user:

- from a long press of nONKEY (interruptible by host) defined by control SHUT_DELAY
- by pressing a reset switch that is connected to port nRESETREQ (non-interruptible)

RESET mode can be forced from the host processor (non-interruptible):

- by asserting nRESETREQ (falling edge)
- by writing to control SHUTDOWN

DA9061 error conditions that force RESET mode (non-interruptible) are:

- no WATCHDOG write (WDKICK signal assertion) from the host inside the watchdog time window (if watchdog was enabled)
- an under-voltage detected on VSYS ($V_{SYS} < V_{DD_FAULT_LOWER}$)
- an internal junction over-temperature

With the INT_SD_MODE, HOST_SD_MODE and KEY_SD_MODE controls, the shutdown sequences from internal fault, host or user triggered, are individually configured to either implement the reverse timing of the power-up sequence or transfer immediately to the RESET mode by skipping any delay from sequencer or dummy slot timers. For the host to determine the reason for the reset a FAULT_LOG register stores the root cause (either KEY_RESET or NRESETREQ). The host processor resets this register by writing asserted bits with 1.

KEY_SD_MODE = 1 triggers a complete power on reset (POR) (instead of entering RESET mode) after the related keys are pressed extendedly.

If an OTP read is aborted, DA9061 enters RESET mode without an asserted bit inside register FAULT_LOG.

A shutdown sequence to RESET mode will start with the assertion of the nRESET port. After the sequencer completes the power down sequence (sequencer position 0), DA9061 continues to RESET mode with only the following active circuits: LDOCORE (at reduced output voltage 2.2 V), control interfaces and GPIOs, BCD counter, band-gap and over-temperature/VSYS comparators. All regulators, except for LDO1, are automatically disabled to avoid battery drainage. As described in Section 7.1.3, nRESET is always asserted at the beginning of a shutdown sequence to RESET mode, and remains asserted when DA9061 is in RESET mode.

When entering RESET mode, all user and system events are cleared. The DA9061's register configuration will be re-loaded from OTP when leaving the RESET mode (with the exception of control AUTO_BOOT in case of a VDD_START fault).

FAULT_LOG, GP_ID_10 to GP_ID_19 and other non-OTP loaded registers will not be changed when leaving the RESET mode.

Some reset conditions such as writing a 1 to control SHUTDOWN, a watchdog error, or a junction over-temperature will be automatically cleared. Other reset triggers such as asserting nRESETREQ, need to be released to proceed from RESET to POWERDOWN mode. If the application requires regulators to discharge completely before a power-up sequence, a minimum duration of the RESET mode can be selected via RESET_DURATION.

The RESET_DURATION only applies when a PMIC is powered down through the RESET state, such as a result of a SHUTDOWN command, nRESETREQ, or VSYS under-voltage fault. The RESET_DURATION does not apply to a PMIC cold-boot.

If the reset was initiated by a long nONKEY press, initially only KEY_RESET is set and the nIRQ port will be asserted. KEY_RESET signals the host that a shutdown sequence is started. If the host does not then clear KEY_RESET within 1 s by writing a 1 to the related bit in register FAULT_LOG, the

PMIC for Applications Requiring up to 6 A

shutdown sequence will complete. When the reset condition has disappeared, DA9061 requires a supply ($V_{SYS} > V_{DD_FAULT_UPPER}$) that provides enough power to start-up from the POWERDOWN mode.

7.8.3 POWERDOWN Mode

The POWERDOWN mode is a low-power state where most of the regulators are disabled. The transition from active to POWERDOWN mode (and vice versa) is handled by the programmable sequencer. Entry to POWERDOWN mode from ACTIVE mode is triggered by the de-assertion of SYSTEM_EN (either via SYS_EN or register access) or by a short press of nONKEY. The POWERDOWN mode is also passed during start-up and shutdown to RESET mode sequences.

In POWERDOWN mode the internal supplies are enabled, and the control interface and GPIOs are operational.

The power state machine features a retry counter that limits the number of transitions from POWERDOWN to ACTIVE under certain conditions. A watchdog timeout triggers POWERDOWN mode entry, but it does not necessarily clear the conditions that trigger a transition back to the ACTIVE mode. This could cause an endless loop between the ACTIVE and POWERDOWN modes. Therefore, after each watchdog timeout the retry counter is decremented, and after the retry counter reaches zero, DA9061 blocks all wakeup events and stays in POWERDOWN mode. This freeze function can be regarded as a substate of the POWERDOWN mode that is undetectable from outside the DA9061.

Table 25 describes the state transitions with a level-sensitive wakeup and the freeze function.

Table 25: State Transitions with a Level-Sensitive (LS) GPI

Current state	LS GPI	SYS_EN	PWR_EN	Freeze Note 1	Next state
POWERDOWN	x	x	x	1	POWERDOWN
POWERDOWN	0	0	x	0	POWERDOWN
POWERDOWN	x	1	0	0	SYSTEM
POWERDOWN	x	1	1	0	ACTIVE
POWERDOWN	1	x	0	0	SYSTEM
POWERDOWN	1	x	1	0	ACTIVE
SYSTEM	0	0	x	x	POWERDOWN
SYSTEM	x	1	0	x	SYSTEM
SYSTEM	x	1	1	x	ACTIVE
SYSTEM	1	x	0	x	SYSTEM
SYSTEM	1	x	1	x	ACTIVE
ACTIVE	0	0	x	x	POWERDOWN
ACTIVE	x	1	0	x	SYSTEM
ACTIVE	x	1	1	x	ACTIVE
ACTIVE	1	x	0	x	SYSTEM
ACTIVE	1	x	1	x	ACTIVE

Note 1 In this table, Freeze represents the result of the comparison $retry\ count = 0$.

The following events will reset the retry counter and release the state machine from the freeze state:

- De-assertion of all blocked level-sensitive wakeup conditions
- Entry to the RESET mode (over-temperature error, nRESETREQ or long press of nONKEY)

PMIC for Applications Requiring up to 6 A

The freeze operation is illustrated in Figure 18. Once the freeze state is cleared, DA9061 continues operating normally. The freeze function can be enabled in the FREEZE_EN register and the number of retries triggering the freeze can be configured in NFREEZE.

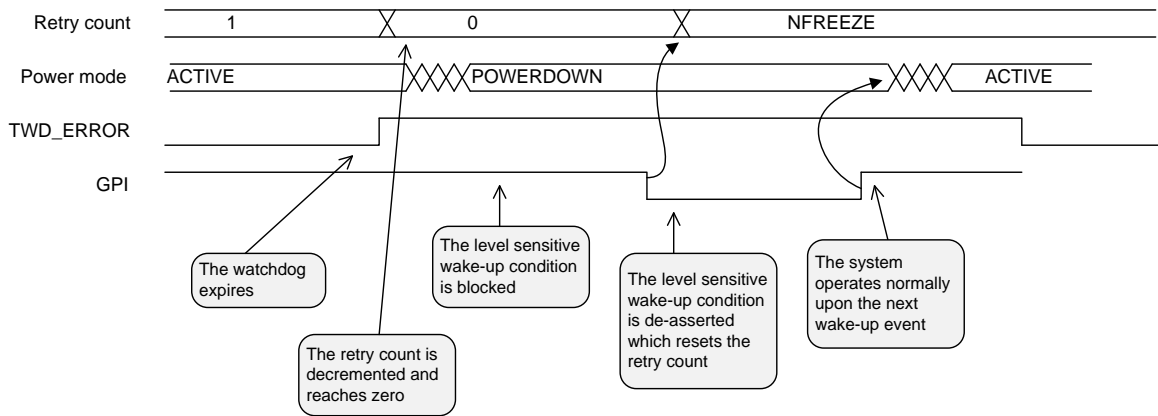

Figure 18: Freeze Function

7.8.4 Power-Up, Power-Down, and Shutdown Sequences

The power-up, power-down, and shutdown sequences, see Figure 17, are handled by the power supply sequencer, see Section 7.9. All power-up sequences are identical, and the power-down sequences mirror the power-up sequences.

The shutdown sequences are also identical to the power-down sequence, but after reaching POWERDOWN mode, the state machine automatically proceeds to RESET mode. The shutdown sequences caused by an internal error or nRESETREQ can be sped up from the INT_SD_MODE and HOST_SD_MODE controls: see Section 7.8.2.

7.8.5 ACTIVE Mode

In the ACTIVE mode, all supplies and functions are active. The transition from POWERDOWN to ACTIVE mode is handled by the programmable sequencer. DA9061 enters ACTIVE mode after the sequence has completed and the watchdog is enabled (if configured to use watchdog).

Status information can be read from the host processor via the 2-wire interface and DA9061 can flag interrupt requests to the host via a dedicated interrupt port (nIRQ).

PMIC for Applications Requiring up to 6 A

7.9 Power Supply Sequencer

DA9061 features a programmable Power Supply Sequencer that handles the system power-up, power-down, and shutdown sequences. The sequencer has a step-up counter, a timer that controls the step period, and a set of comparators that trigger power-on/off events at specific steps of the counter. The structure of the sequencer is depicted in Figure 19.

The sequencer is composed of 16 steps, and the step time can be programmed between 32 μ s and 8.192 ms. The sequencer will step until it reaches a programmable maximum value (MAX_COUNT), whereupon an interrupt is issued. At each step, the sequencer will enable all the functions that are pointing to that particular step.

The power-up and -down sequences cannot be configured separately. When DA9061 is powering down, the sequencer will execute whatever was configured for the power-up sequence but in reverse order. Supplies can also be configured to stay on in POWERDOWN mode. In this case, the sequencer does not disable the regulator but switches to its B-configuration, see Section 7.5.

If any pointer is programmed to a step higher than MAX_COUNT, the function is no longer controlled by the sequencer. Only the regulator control pointers (LDO<x>_STEP, BUCK<x>_STEP) are allowed to point to step 0. Setting any other pointer to step 0, effectively disables that function.

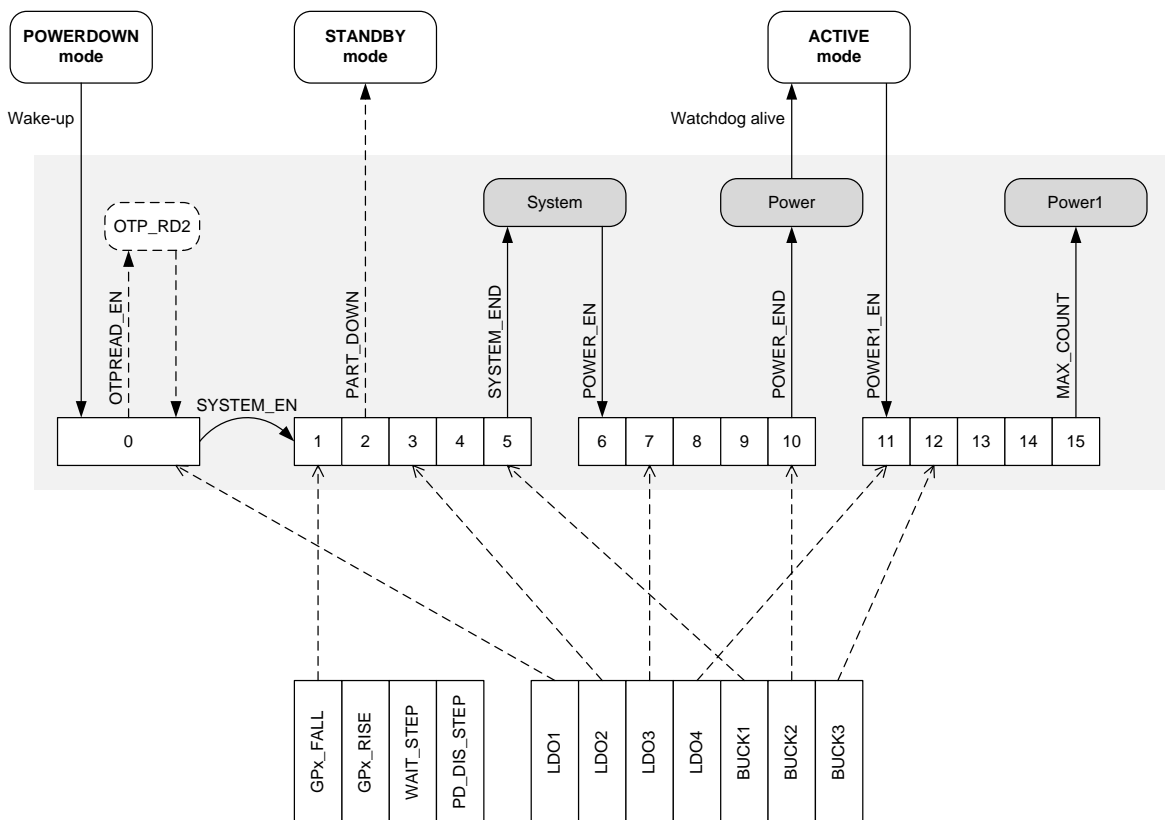

Figure 19: Structure of the Power Supply Sequencer

NOTE

STANDBY mode can only be reached on power-down, not power-up.

PMIC for Applications Requiring up to 6 A

7.9.1 Programmable Slot Delays

The delay between the slots of a sequence is controlled via the programmable value of SEQ_TIME in register SEQ_TIMER. This has a default delay of 128 μ s per slot (min. 32 μ s, max. 8 ms). The delay time between individual supplies can be extended by leaving a consecutive slot(s) with no IDs pointing to it: these are dummy slots. The dummy slots have an independent delay configured by SEQ_DUMMY. These delay times, in register SEQ_TIMER, are (re-)loaded from OTP every time domain SYSTEM begins to power-up. These slot delays also apply to Slot 0.

7.9.2 Sub-Sequences

As illustrated in Figure 19, the sequencer is partitioned into three sub-sequences. These three sub-sequences can be used to define three power modes for the target application and to move between them in a controlled sequence as a response to control signals or register writes.

The first sub-sequence starts from step 0 and ends at a step defined by the SYSTEM_END pointer. After the power-up is triggered, DA9061 performs a partial OTP read (OTP_RD2) if OTPREAD_EN is set. It then waits for control SYSTEM_EN to trigger the first sub-sequence. If SYSTEM_EN is already set in the OTP the first sub-sequence starts automatically after the power-up trigger. Alternatively, SYSTEM_EN can be asserted through the SYS_EN input. When the sequencer reaches the SYSTEM_END step the first sub-sequence is completed and the sequencer starts waiting for control POWER_EN to trigger the second sub-sequence. If POWER_EN is already set in the OTP, the sequencer does not stop after the first sub-sequence. Alternatively, POWER_EN can be asserted through the PWR_EN input or via a register access.

The second sub-sequence starts from the step following SYSTEM_END and stops at a step defined by the POWER_END pointer. When the sequencer reaches the POWER_END step (and the watchdog is active), DA9061 enters ACTIVE mode. The final sub-sequence is triggered by asserting POWER1_EN via a register write. The third sub-sequence starts from the step following POWER_END and stops at a step defined by the MAX_COUNT pointer. If MAX_COUNT points to an earlier step than SYSTEM_END or POWER_END the remaining steps of the sequencer are disabled.

The power-down sequences are executed in reverse order to the power-up sequences. If the power-down sequence is triggered from the ACTIVE mode by de-asserting POWER_EN, the sequencer stops after reversing to the SYSTEM_END step. However, if the power-down sequence is triggered by de-asserting SYSTEM_EN, the sequencer does not stop and reverses back to step 0. Furthermore, if the power-down sequence is triggered by a watchdog timeout, the sequencer reverses to step 0 immediately.

A partial power-down can be achieved by setting control STANDBY. This makes the sequencer stop at the step pointed to by the PART_DOWN pointer. The next power-up will then start from the PART_DOWN step, instead of step 0. The PART_DOWN pointer has to point to a step smaller than the SYSTEM_END pointer.

7.9.3 Regulator Control

Each of DA9061's buck converters and LDOs can be assigned to any of the sequencer steps. In general, when the sequencer reaches a step to which a regulator is assigned, that regulator is enabled by the sequencer. Likewise, when the sequencer reaches the same step on the way down, the regulator is disabled. Multiple supplies can point to the same counter step, however, enabling multiple regulators in the same slot can lead to increased in-rush currents.

In the simplest scheme, the sequencer enables regulators during a power-up, and disables them during a power-down. This functionality is achieved by setting BUCK<x>_AUTO/LDO<x>_AUTO and clearing BUCK<x>_CONF/LDO<x>_CONF. Alternatively, the sequencer can be configured to keep the regulator enabled, but switch between the A and B settings in ACTIVE and POWERDOWN modes. The functionality of the BUCK<x>_AUTO/LDO<x>_AUTO and BUCK<x>_CONF/LDO<x>_CONF controls is summarized in Table 26.

PMIC for Applications Requiring up to 6 A

Table 26: Regulator Control Functionality of the Power Supply Sequencer

Power-Up (Sequencer Direction Up)						
AUTO	CONF	POWERDOWN Mode (Before)		ACTIVE Mode (After)		Sequencer Functionality
		EN	SEL	EN	SEL	
0	0	x	x	0	0	The regulator is disabled at the step pointed to by BUCK<x>_STEP/LDO<x>_STEP and the A-setting (VBUCK<x>_A/VLDO<x>_A) is activated.
x	1	x	x	1	0	The regulator is enabled at the step pointed to by BUCK<x>_STEP/LDO<x>_STEP and the A-setting (VBUCK<x>_A/VLDO<x>_A) is activated.
1	x	x	x	1	0	
Power-Down (Sequencer Direction Down)						
AUTO	CONF	ACTIVE Mode (Before)		POWERDOWN Mode (After)		
		EN	SEL	EN	SEL	
x	0	x	x	0	0	The regulator is disabled at the step pointed to by BUCK<x>_STEP/LDO<x>_STEP and the A-setting (VBUCK<x>_A/VLDO<x>_A) is activated.
x	1	x	x	1	1	The regulator stays enabled but it is switched to the B-setting (VBUCK<x>_B/VLDO<x>_B).

Step 0 of the sequencer has a special meaning. If control DEF_SUPPLY is set, the sequencer treats all regulators pointing to step 0 as default supplies. This means that the regulators are enabled automatically when entering the POWERDOWN mode. Regulators assigned to other steps are only enabled after a wakeup condition occurs. Apart from this, step 0 acts the same as steps 1 to 15. If control DEF_SUPPLY = 0, step 0 of the sequencer does not have any affect.

As mentioned in Section 7.6.1, LDO1 can be programmed as an always-on supply. This is achieved by setting controls DEF_SUPPLY, LDO1_CONF, and LDO1_EN in the OTP. In normal operation, when the sequencer moves between ACTIVE and POWERDOWN modes, LDO1 behaves as presented in Table 26. However, if DA9061 moves to the RESET mode, this configuration keeps LDO1 enabled. This is not the case for any other regulator.

7.9.4 GPO Control

Any GPO can be asserted or de-asserted in a sequencer step (GP_RISE<x>_STEP, GP_FALL<x>_STEP). The GPO control is summarized in Table 27. If a GPO is controlled by the sequencer, it is driven to its inactive state when DA9061 is in RESET mode. The GPIO control only works in sequencer steps greater than zero.

Table 27: GPO Control Functionality of the Power Supply Sequencer

GPIO<x>_MODE	GPO State After Reset	Sequencer Direction	Previous GPO state	GPO Transition at GP_RISE<x>	GPO Transition at GP_FALL<x>
0 (active low)	High	Up	High	High to low	-
			Low	-	Low to high
		Down	High	-	High to low
			Low	Low to high	-
1 (active high)	Low	Up	High	-	High to low
			Low	Low to high	-
		Down	High	High to low	-
			Low	-	Low to high

PMIC for Applications Requiring up to 6 A

7.9.5 Wait Step

One of the sequencer steps (any step greater than zero) can be configured as a wait step, in which the sequencer stays until an event is detected in the GPI3 input, see Section 7.3.1.2.

NOTE

The E_GPI3 event has to be cleared after the power-up sequence completes. Otherwise, the wait step in the next power-up sequence will be ineffective.

The wait step features an optional 500 ms timeout, which can be used when the wait event never occurs. If the timeout occurs, the steps following the wait step are not executed and a shutdown sequence to RESET mode is triggered. The shutdown reason is signalled with the WAIT_SHUT bit. Alternatively, the wait step can be used as a configurable delay in the sequence (WAIT_MODE, WAIT_TIME).

7.9.6 Power-Down Disable

The PD_DIS_STEP pointer can be used to define a step in the power-up sequence above which a group of functions will be enabled. The functions concerned can be controlled in the PD_DIS register. Similarly, in the power-down sequence, the same groups of functions will be disabled when the sequencer proceeds below the PD_DIS_STEP.

7.10 Junction Temperature Supervision

To protect DA9061 from damage due to excessive power dissipation, the junction temperature is continuously monitored. The monitoring is split into three thresholds T_{WARN} (125 °C), T_{CRIT} (140 °C), and T_{POR} (150 °C).

If the junction temperature rises above the first threshold (T_{WARN}), the event E_TEMP (in register EVENT_B) is asserted. If the event is not masked, this will issue an interrupt. This first level of temperature supervision is intended for non-invasive temperature control, where the necessary measures for cooling the system down are left to the host software.

If the junction temperature increases even further and crosses the second threshold (T_{CRIT}) the temperature error flag TEMP_CRIT (in register FAULT_LOG) is issued and a shutdown sequence to RESET mode is triggered, see Section 7.8.2. The nRESET output is asserted at the beginning of the shutdown sequence. Therefore, the second level of the temperature supervision does not rely on the host software to take counter-measures. The fault flag can be evaluated by the application after the next power up.

There is also a third temperature threshold (T_{POR}) which causes DA9061 to enter RESET mode without any sequencing and stop all functions. This prevents possible permanent damage due to fast temperature increases.

7.11 System Supply Voltage Supervision

Two comparators supervise the system supply V_{SYS}. One is monitoring the under-voltage level (V_{DD_FAULT_LOWER}) and the other is indicating a good system supply (V_{DD_FAULT_UPPER}). The V_{DD_FAULT_LOWER} threshold is OTP configurable and can be set via the VDD_FAULT_ADJ control from 2.5 V to 3.25 V in 50 mV steps. The V_{DD_FAULT_UPPER} threshold is also OTP configurable and can be set via the VDD_HYST_ADJ control from 100 mV to 450 mV higher than the V_{DD_FAULT_LOWER} threshold.

V_{SYS} dropping below the V_{DD_FAULT_UPPER} threshold asserts the event E_VDD_WARN (in register EVENT_B). If the event is not masked, this will issue an interrupt, which can be used by the host processor as an indication to decrease its activity.

If V_{SYS} drops below V_{DD_FAULT_LOWER} for more than 100 ms, the supply error flag VDD_FAULT (in register FAULT_LOG) is asserted and a shutdown sequence to RESET mode is triggered, see Section 7.8.2. The nRESET output is asserted at the beginning of the shutdown sequence. The status can also be reported using a dedicated nVDD_FAULT signal, see Section 7.3.2.1.

PMIC for Applications Requiring up to 6 A

7.12 Internal Oscillator

An internal oscillator provides a nominal 6.0 MHz clock that is divided to 3.0 MHz for the buck converters. The frequency of the internal oscillator is adjusted during the initial start-up sequence of DA9061 to within 5 % of the nominal 6.0 MHz.

Some applications require that the software is able to modify the oscillator frequency at runtime, for example to avoid interference effects caused by harmonics of the buck converter operating frequency. This can be achieved by writing a non-zero value to control OSC_FRQ. This control is a signed 4-bit value where each step changes the frequency by about 1.33 %, which gives a range from -10.65 % (-8) to +9.33 % (+7).

The tolerance of this frequency will affect most absolute timer values and PWM repetition rates.

7.13 Watchdog

The watchdog provides system monitoring functionality. A watchdog timeout triggers shutdown to POWERDOWN mode, signalled in register FAULT_LOG. The watchdog can also be configured to control a secondary reset output in addition to nRESET. This requires that one of the GPIOs is configured as a GPO, controlled by the sequencer. The assertion/de-assertion is used as a reset, and the GPIO is configured as a sequencer controlled GPO. This way, after the watchdog triggers the power-down, the reset output is asserted by the sequencer during the power-down sequence.

Once enabled, the watchdog cannot be stopped and it runs in ACTIVE mode (this feature can be bypassed with an OTP configuration). The source clock of the watchdog is the internally generated slow frequency clock.

After a cold boot, the watchdog is activated when entering ACTIVE mode. This first watchdog kick is required for DA9061 to move to the ACTIVE mode after a cold boot, as illustrated in [Figure 17](#). After the watchdog is activated, the host must kick the watchdog periodically within the watchdog period programmed with the TWDSCALE control. An interrupt can be generated to warn the host processor of the watchdog timeout. The time for the warning interrupt is half of the watchdog period.

The kick can be done by a register write to control WATCHDOG (reg. CONTROL_F) or with the GPIO0 pin configured as a WDKICK input. With control WDG_MODE = 1, the behavior of the WDKICK input is modified so that either a pulse or a permanently asserted input prevents a watchdog timeout. In this mode the parameter tWDMIN is not applicable.

If the host processor fails to feed the watchdog, DA9061 asserts a fault bit and enters POWERDOWN mode. The watchdog timeout can also be configured to assert a reset output. This requires that one of the GPIOs is configured as a reset output and assigned to a power sequencer step, see [Section 7.9](#).

After each watchdog timeout a retry counter is decremented. If the retry counter reaches zero, DA9061 will stay in POWERDOWN mode, as described in [Section 7.8.3](#). The number of allowed retries can be programmed in the NFREEZE control.

PMIC for Applications Requiring up to 6 A

8 Register Map

8.1 Register Page Control

The device register map is larger than the address range directly addressable from the host interface. The page control register provides the higher address bits and control for using the paging mechanism. There are several copies of this register, one per host interface. These copies are mirrored to addresses 0x080, 0x100 and 0x180.

8.2 Overview

Table 28 provides a summary of the registers. A description of each register is provided in [Appendix A: Register Descriptions](#).

Table 28: Register Summary

Address	Name	7	6	5	4	3	2	1	0	
Page Control										
0x000	PAGE_CON	REVERT	WRITE_MODE	PAGE						
Power Manager Control and Monitoring										
0x001	STATUS_A	Reserved				DVC_BUSY	Reserved	NONKEY		
0x002	STATUS_B	Reserved			GPIO4	GPIO3	GPIO2	GPIO1	GPIO0	
0x004	STATUS_D	Reserved				LDO4_ILIM	LDO3_ILIM	LDO2_ILIM	LDO1_ILIM	
0x005	FAULT_LOG	WAIT_SHUT	NRESETREQ	KEY_RESET	TEMP_CRIT	VDD_START	VDD_FAULT	POR	TWD_ERROR	
IRQ Events										
0x006	EVENT_A	Reserved	EVENTS_C	EVENTS_B	E_SEQ_RDY	E_WDG_WARN	Reserved	Reserved	E_NONKEY	
0x007	EVENT_B	E_VDD_WARN	Reserved	E_DVC_RDY	Reserved	E_LDO_LIM	Reserved	E_TEMP	Reserved	
0x008	EVENT_C	Reserved			E_GPIO4	E_GPIO3	E_GPIO2	E_GPIO1	E_GPIO0	
IRQ Masks										
0x00A	IRQ_MASK_A	Reserved			M_SEQ_RDY	M_WDG_WARN	Reserved	Reserved	M_NONKEY	
0x00B	IRQ_MASK_B	M_VDD_WARN	Reserved	M_DVC_RDY	Reserved	M_LDO_LIM	Reserved	M_TEMP	Reserved	
0x00C	IRQ_MASK_C	Reserved			M_GPIO4	M_GPIO3	M_GPIO2	M_GPIO1	M_GPIO0	
System Control										
0x00E	CONTROL_A	Reserved	M_POWER1_EN	M_POWER_EN	M_SYSTEM_EN	STANDBY	POWER1_EN	POWER_EN	SYSTEM_EN	
0x00F	CONTROL_B	BUCK_SLOWSTART	NFREEZE	nONKEY_LOCK		NRES_MODE	FREEZE_EN	WATCHDOG_PD	Reserved	
0x010	CONTROL_C	DEF_SUPPLY	SLEW_RATE	OTPREAD_EN		AUTO_BOOT	DEBOUNCING			
0x011	CONTROL_D	Reserved					TWDSCALE			
0x012	CONTROL_E	V_LOCK	Reserved			Reserved	Reserved	Reserved	Reserved	
0x013	CONTROL_F	Reserved					WAKE_UP	SHUTDOWN	WATCHDOG	
0x014	PD_DIS	PMCONT_DIS	Reserved	BBAT_DIS	CLDR_PAUSE	Reserved	PMIF_DIS	Reserved	GPIO_DIS	
GPIO Control										
0x015	GPIO_0_1	GPIO1_WEN	GPIO1_TYPE	GPIO1_PIN		GPIO0_WEN	GPIO0_TYPE	GPIO0_PIN		
0x016	GPIO_2_3	GPIO3_WEN	GPIO3_TYPE	GPIO3_PIN		GPIO2_WEN	GPIO2_TYPE	GPIO2_PIN		
0x017	GPIO_4	Reserved				GPIO4_WEN	GPIO4_TYPE	GPIO4_PIN		
0x01C	GPIO_WKUP_MODE	Reserved			GPIO4_WKUP_MODE	GPIO3_WKUP_MODE	GPIO2_WKUP_MODE	GPIO1_WKUP_MODE	GPIO0_WKUP_MODE	
0x01D	GPIO_MODE0_4	Reserved			GPIO4_MODE	GPIO3_MODE	GPIO2_MODE	GPIO1_MODE	GPIO0_MODE	
0x01E	GPIO_OUT0_2	GPIO2_OUT		GPIO1_OUT			GPIO0_OUT			
0x01F	GPIO_OUT3_4	Reserved			GPIO4_OUT		GPIO3_OUT			
Power Supply Control										
0x021	BUCK1_CONT	Reserved	VBUCK1_GPI		Reserved	BUCK1_CONF	BUCK1_GPI		BUCK1_EN	
0x022	BUCK3_CONT	Reserved	VBUCK3_GPI		Reserved	BUCK3_CONF	BUCK3_GPI		BUCK3_EN	

PMIC for Applications Requiring up to 6 A

Address	Name	7	6	5	4	3	2	1	0
0x024	BUCK2_CONT	Reserved	VBUCK2_GPI		Reserved	BUCK2_CONF	BUCK2_GPI		BUCK2_EN
0x026	LDO1_CONT	LDO1_CONF	VLDO1_GPI		Reserved	LDO1_PD_DIS	LDO1_GPI		LDO1_EN
0x027	LDO2_CONT	LDO2_CONF	VLDO2_GPI		Reserved	LDO2_PD_DIS	LDO2_GPI		LDO2_EN
0x028	LDO3_CONT	LDO3_CONF	VLDO3_GPI		Reserved	LDO3_PD_DIS	LDO3_GPI		LDO3_EN
0x029	LDO4_CONT	LDO4_CONF	VLDO4_GPI		Reserved	LDO4_PD_DIS	LDO4_GPI		LDO4_EN
0x032	DVC_1	VLDO4_SEL	VLDO3_SEL	VLDO2_SEL	VLDO1_SEL	VBUCK2_SEL	VBUCK3_SEL	Reserved	VBUCK1_SEL
Power Sequencer									
0x081	SEQ	NXT_SEQ_START			SEQ_POINTER				
0x082	SEQ_TIMER	SEQ_DUMMY			SEQ_TIME				
0x083	ID_2_1	LDO2_STEP			LDO1_STEP				
0x084	ID_4_3	LDO4_STEP			LDO3_STEP				
0x088	ID_12_11	PD_DIS_STEP			Reserved				
0x089	ID_14_13	Reserved			BUCK1_STEP				
0x08A	ID_16_15	BUCK2_STEP			BUCK3_STEP				
0x08D	ID_22_21	GP_FALL1_STEP			GP_RISE1_STEP				
0x08E	ID_24_23	GP_FALL2_STEP			GP_RISE2_STEP				
0x08F	ID_26_25	GP_FALL3_STEP			GP_RISE3_STEP				
0x090	ID_28_27	GP_FALL4_STEP			GP_RISE4_STEP				
0x091	ID_30_29	GP_FALL5_STEP			GP_RISE5_STEP				
0x092	ID_32_31	Reserved			WAIT_STEP				
0x095	SEQ_A	POWER_END			SYSTEM_END				
0x096	SEQ_B	PART_DOWN			MAX_COUNT				
0x097	WAIT	WAIT_DIR		TIME_OUT	WAIT_MODE	WAIT_TIME			
0x099	RESET	RESET_EVENT		RESET_TIMER					
Power Supply Control									
0x09A	BUCK_ILIM_A	Reserved			BUCK2_ILIM				
0x09B	BUCK_ILIM_B	Reserved			BUCK3_ILIM				
0x09C	BUCK_ILIM_C	Reserved			BUCK1_ILIM				
0x09E	BUCK1_CFG	BUCK1_MODE		BUCK1_PD_DIS	Reserved				Reserved
0x09F	BUCK3_CFG	BUCK3_MODE		BUCK3_PD_DIS	Reserved	Reserved	Reserved		
0x0A0	BUCK2_CFG	BUCK2_MODE		BUCK2_PD_DIS	Reserved				
0x0A4	VBUCK1_A	BUCK1_SL_A	VBUCK1_A						
0x0A5	VBUCK3_A	BUCK3_SL_A	VBUCK3_A						
0x0A7	VBUCK2_A	BUCK2_SL_A	VBUCK2_A						
0x0A9	VLDO1_A	LDO1_SL_A	Reserved	VLDO1_A					
0x0AA	VLDO2_A	LDO2_SL_A	Reserved	VLDO2_A					
0x0AB	VLDO3_A	LDO3_SL_A	Reserved	VLDO3_A					
0x0AC	VLDO4_A	LDO4_SL_A	Reserved	VLDO4_A					
0x0B5	VBUCK1_B	BUCK1_SL_B	VBUCK1_B						
0x0B6	VBUCK3_B	BUCK3_SL_B	VBUCK3_B						
0x0B8	VBUCK2_B	BUCK2_SL_B	VBUCK2_B						
0x0BA	VLDO1_B	LDO1_SL_B	Reserved	VLDO1_B					
0x0BB	VLDO2_B	LDO2_SL_B	Reserved	VLDO2_B					
0x0BC	VLDO3_B	LDO3_SL_B	Reserved	VLDO3_B					
0x0BD	VLDO4_B	LDO4_SL_B	Reserved	VLDO4_B					
Customer Trim and Configuration									
0x105	INTERFACE	IF_BASE_ADDR			Reserved				
0x106	CONFIG_A	Reserved	PM_IF_HSM	PM_IF_FMP	PM_IF_V	IRQ_TYPE	PM_O_TYPE	Reserved	PM_I_V
0x107	CONFIG_B	Reserved	VDD_HYST_ADJ			VDD_FAULT_ADJ			

PMIC for Applications Requiring up to 6 A

Address	Name	7	6	5	4	3	2	1	0	
0x108	CONFIG_C	Reserved	BUCK2_CLK_INV	Reserved	BUCK3_CLK_INV	BUCK1_CLK_INV	BUCK_ACTV_DISC_HRG	Reserved		
0x109	CONFIG_D	Reserved		FORCE_RESET	Reserved		SYSTEM_EN_RD	NIRQ_MODE	GPLV	
0x10A	CONFIG_E	Reserved			BUCK2_AUTO	Reserved	BUCK3_AUTO	Reserved	BUCK1_AUTO	
0x10C	CONFIG_G	Reserved				LDO4_AUTO	LDO3_AUTO	LDO2_AUTO	LDO1_AUTO	
0x10D	CONFIG_H	Reserved	BUCK1_FCM	Reserved	Reserved	Reserved	Reserved			
0x10E	CONFIG_I	LDO_SD	INT_SD_MODE	HOST_SD_MODE	KEY_SD_MODE	WATCHDOG_S D	nONKEY_SD	NONKEY_PIN		
0x10F	CONFIG_J	IF_RESET	TWOWIRE_TO	RESET_DURATION		SHUT_DELAY		KEY_DELAY		
0x110	CONFIG_K	Reserved			GPIO4_PUPD	GPIO3_PUPD	GPIO2_PUPD	GPIO1_PUPD	GPIO0_PUPD	
0x112	CONFIG_M	OSC_FRQ				WDG_MODE	Reserved	Reserved	Reserved	
Customer Device Specific										
0x121	GP_ID_0	GP_0								
0x122	GP_ID_1	GP_1								
0x123	GP_ID_2	GP_2								
0x124	GP_ID_3	GP_3								
0x125	GP_ID_4	GP_4								
0x126	GP_ID_5	GP_5								
0x127	GP_ID_6	GP_6								
0x128	GP_ID_7	GP_7								
0x129	GP_ID_8	GP_8								
0x12A	GP_ID_9	GP_9								
0x12B	GP_ID_10	GP_10								
0x12C	GP_ID_11	GP_11								
0x12D	GP_ID_12	GP_12								
0x12E	GP_ID_13	GP_13								
0x12F	GP_ID_14	GP_14								
0x130	GP_ID_15	GP_15								
0x131	GP_ID_16	GP_16								
0x132	GP_ID_17	GP_17								
0x133	GP_ID_18	GP_18								
0x134	GP_ID_19	GP_19								
0x181	DEVICE_ID	DEV_ID								
0x182	VARIANT_ID	MRC				VRC				
0x183	CUSTOMER_ID	CUST_ID								
0x184	CONFIG_ID	CONFIG_REV								

PMIC for Applications Requiring up to 6 A

9 Application Information

9.1 Component Selection

The following recommended components are examples selected from requirements of a typical application. The final component selection will be dependent on the specific application. The electrical characteristics (for example, supported voltage/current range) have to be cross-checked and component types may need to be adapted from the individual needs of the target circuitry.

9.1.1 Resistors

Table 29: Recommended Resistors

Pin	Value	Tol.	Size (mm)	Rating (mW)	Part
IREF	200 kΩ	±1%	1005	100	Panasonic ERJ2RKF2003x

9.1.2 Capacitors

Ceramic capacitors are used as bypass capacitors at all VDD and output rails. When selecting a capacitor, especially ones with high capacitance and small size, the DC bias characteristic has to be taken into account.

On the VSYS main supply rail, a minimum distributed capacitance of 40 μF (actual capacitance after voltage and temperature derating) is required.

Buck input capacitors should be within 1.5 mm distance from the supply pin, and the output capacitor should be close to the inductor.

Table 30: Recommended Capacitors

Pin	Value	Tol. (%)	Size (mm)	Height (mm)	Temp. Char.	Rating (V)	Part
VLDO1	1 μF	±10	1005	0.55	X5R	10	GRM155R61A105KE15
VLDOx	2.2 μF	±20	1005	0.55	X5R	10	GRM155R60J225ME95#
VBUCK2 IOUT ≤ 1.5 A	2 x 22 μF	±20	2012	0.95	X5R	6.3	GRM219R60J226M***
		±20	1005	0.5	X5R	4.0	CL05A226MR5NZNC
VBUCK2 IOUT > 1.5 A	2 x 47 μF	±20	2012	0.95	X5R	4.0	GRM219R60G476M***
		±20	1608	0.8	X5R	4.0	CL10A476MR8NZN
VBUCK3	2 x 22 μF	±20	1608	1	X5R	6.3	GRM188R60J226MEA0
		±20	1005	0.5	X5R	4.0	CL05A226MR5NZNC
VBUCK1 (half-current mode)	2 x 22 μF	±20	1608	1	X5R	6.3	GRM188R60J226MEA0
		±20	1005	0.5	X5R	4.0	CL05A226MR5NZNC
VBUCK1 (full-current mode)	2 x 47 μF	±20	2012	0.95	X5R	4.0	GRM219R60G476M***61
		±20	1608	0.8	X5R	4.0	CL10A476MR8NZN
VSYS	1 x 1 μF	±10	1005	0.5	X5R	10	GRM155R61A105KE15D
VDD_BUCKx	2 x 22 μF	±20	2012	1.25	X5R	10	LMK212BJ226MG-T
	4 x 10 μF	±20	1005	0.5	X5R	10	GRM155R61A106ME21
VDD_LDO2	1 x 1 μF	±10	1005	0.5	X5R	10	GRM155R61A105KE15D
VDD_LDO34	1 x 1 μF	±10	1005	0.5	X5R	10	GRM155R61A105KE15D
VDDCORE	2.2 μF	±20	1005	0.55	X5R	6.3	GRM155R60J225ME95#

PMIC for Applications Requiring up to 6 A

Pin	Value	Tol. (%)	Size (mm)	Height (mm)	Temp. Char.	Rating (V)	Part
VREF	220 nF	±15%	1005	0.5	X5R	16	GRM155R71C224KA12

9.1.3 Inductors

Inductors should be selected based upon the following parameters:

- I_{SAT} specifies the current causing a reduction in the inductance by a specific amount, typically 30 %
- I_{RMS} specifies the current causing a temperature rise of a specific amount
- DC resistance (DCR) is critical for converter efficiency and should be therefore minimized.
- ESR at the buck switching frequency is critical to converter efficiency in PFM mode and should be therefore minimized.

Inductance is given in [Table 31](#).

Table 31: Recommended Inductors

Buck	Value	I_{SAT} (A)	I_{RMS} (A)	DCR (Typ. mΩ)	Size (W×L×H mm)	Part
Buck1 (half-current mode), Buck2, Buck3	1 μH	2.7	2.3	55	2.0×1.6×1.0	Toko 1285AS-H-1R0M
		2.65	2.45	60	2.0×1.6×1.0	Tayo Yuden MAKK2016T1R0M
		2.9	2.2	60	2.0×1.6×1.0	TDK TFM201610A-1R0M
Buck1 (full-current mode)	1 μH	3.4	3	60	2.5×2.0×1.0	Toko1269AS-H-1R0M
		3.6	3.1	45	2.5×2.0×1.2	Tayo Yuden MAMK2520T1R0M
		3.8	3.5	45	2.5×2.0×1.2	Toko 1239AS-H-1R0M
		3.9	3.1	48	3.2×2.5×1.0	Toko1276AS-H-1R0M
		4.7	4.1	35	2.5×2.0×1.2	TDK TFM252012ALMA1R0MT AA
		3.35	2.5	52	3.0×3.0×1.2	Cyntec PST031B-1R0MS
		4.9	7.9	18.5	3.5×3.5×1.5	Coilcraft XGL3515-102ME
8.8	12	8.2	4.0×4.0×2.1	Coilcraft XGL4020-102ME		

PMIC for Applications Requiring up to 6 A

9.2 PCB Layout

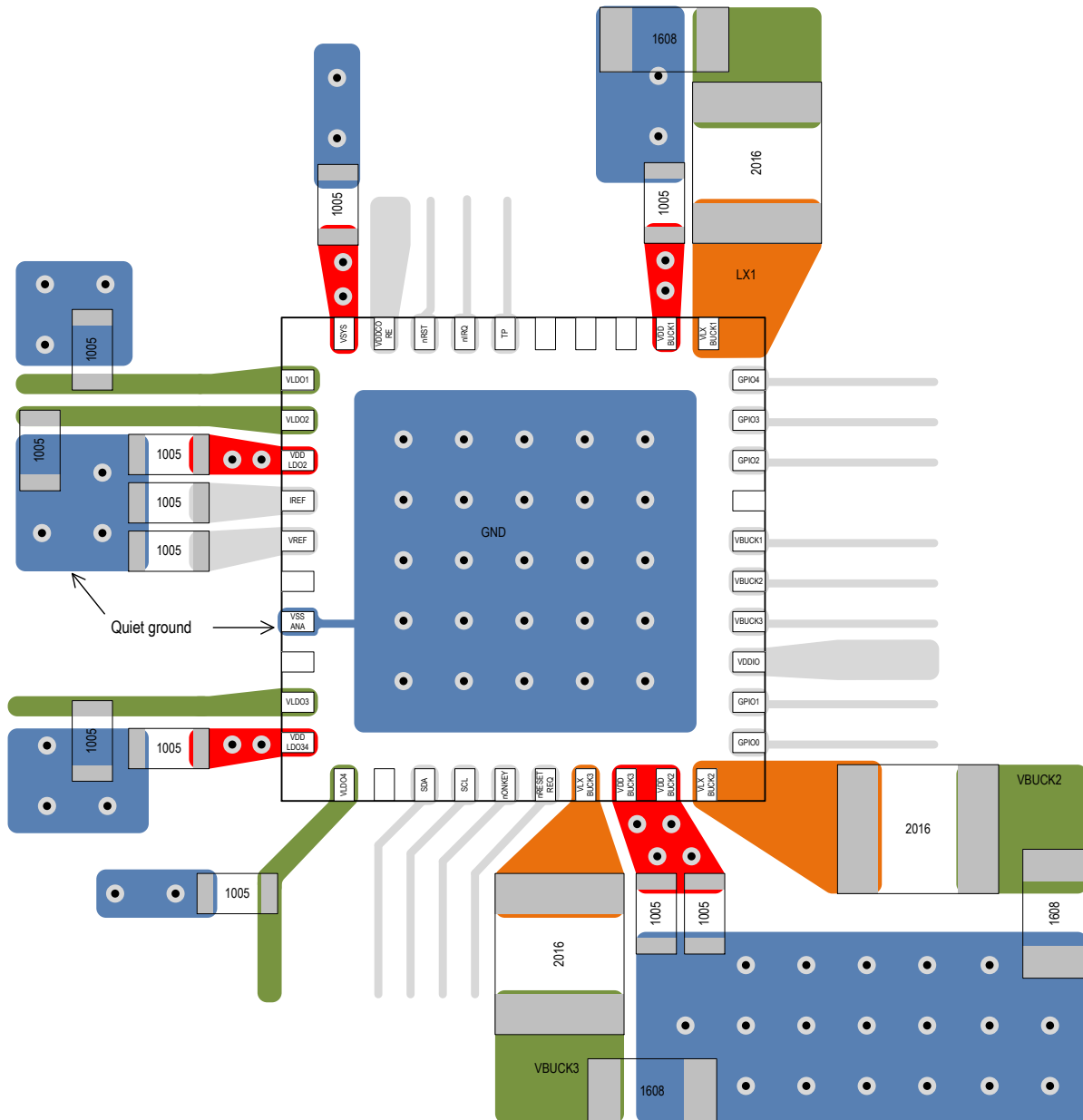

Figure 20: PCB Layout for DA9061

9.2.1 General Recommendations

Appropriate trace width and quantity of vias should be used for all power supply paths.

Too high trace resistances can prevent the system from achieving the best performance, for example, the efficiency and the current ratings of switching converters might be degraded. Furthermore, the PCB may be exposed to thermal hot spots, which can lead to critical overheating due to the positive temperature coefficient of copper.

Special care must be taken with the DA9061 pad connections. The traces connecting the pads should be of the same width as the pads and they should become wider as soon as possible.

It is recommended to create a separate quiet ground to which the VREF capacitor, IREF resistor, and the crystal capacitors are connected. The PCB layout should ensure these component grounds are kept quiet, that is, they should be separated from the main ground return path for the noisy power

PMIC for Applications Requiring up to 6 A

ground. The quiet ground can then be connected to the main ground at the paddle, as shown in [Figure 20](#).

All traces carrying high discontinuous currents should be kept as short as possible.

Noise sensitive analog signals, such as feedback lines or crystal connections, should be kept away from traces carrying pulsed analog or digital signals. This can be achieved by separation or shielding with quiet signals or ground traces.

9.2.2 LDOs and Switched Mode Supplies

The placement of the distributed capacitors on the VSYS rail must ensure that all VDD inputs and VSYS are connected to a bypass capacitor close to the pad. It is recommended placing at least two 1 μ F capacitors close to the VDD_LDOx pads and at least one 10 μ F close to the VDD_BUCKx pads.

Using a local power plane underneath the device for VSYS might be considered.

Transient current loops in the area of the switching converters should be minimized.

The common references (IREF, VREF) should be placed close to the device and cross-coupling to any noisy digital or analog trace must be avoided.

Output capacitors of the LDOs can be placed close to the input pins of the supplied devices (remote from the DA9061).

Care must be taken with trace routing to ensure that no current is carried on feedback lines of the buck output voltages (VBUCK<x>).

The inductor placement is less critical since parasitic inductances have negligible effect.

9.2.3 Optimizing Thermal Performance

DA9061 features a ground paddle which should be connected with as many vias as possible to the PCB's main ground plane in order to achieve good thermal performance.

Solder mask openings for the landing pads must be arranged to prohibit solder flowing into vias.

PMIC for Applications Requiring up to 6 A

10 Ordering Information

The ordering number consists of the part number followed by a suffix indicating the packing method. The “xx” represents a placeholder for the specific OTP variant. For details and availability, please consult Dialog’s [website](#) or your local sales representative.

Table 32: Ordering Information

Part Number	Package (mm)	Package Description	MOQ
Consumer / Industrial: 25 °C production testing			
DA9061-xxAM1	QFN40, 6 mm x 6 mm	Tray, 490 pcs	14 Trays - 6860
DA9061-xxAM2, Note 1	QFN40, 6 mm x 6 mm	T&R, 4000 pcs	
DA9061-xxAMC	QFN40, 6 mm x 6 mm	T&R, 1100 pcs	6 Reels, - 6600

Note 1 Large reel sizes are no longer supported, contact sales for further information

11 Package Marking

Package Marking		
A1 Corner >	Marking Content	Format
1st		Orientation
2nd		Logo
3rd	D A 9 0 6 1	Part No.
4th	x x v v - A T	OTP/Silicon Version/Option
5th	y y w w z z z z	Date Code
Date Code Format: yy = Year, ww = Week, zzzz = Traceability		
xx identifies the OTP Variant, vv may be used to show the silicon version.		
-A and -AT optionally indicate the Automotive and Automotive high temp test options.		

PMIC for Applications Requiring up to 6 A

Appendix A Register Descriptions

This appendix describes the registers summarized in Section 8. In the following tables, if the description does not explicitly list behaviors for 0 and 1, then the description applies to 1 only.

A.1 PAGE 0

A.1.1 Page Control

Table 33: PAGE_CON (0x000)

Field	Bit	Type	Description
REVERT	7:7	R/W	0: PAGE switches the register page until rewritten. 1: PAGE reverts to 0 after one access.
WRITE_MODE	6:6	R/W	2-wire sequential write style. 0: Write data to consecutive addresses 1: Write data to random addresses using address/data pairs
<i>Reserved</i>	5:2	R/W	<i>Reserved</i>
PAGE	1:0	R/W	The top 2 bits of the register address. 00: Selects register space 0x00 to 0x7F 01: Selects register space 0x80 to 0xFF 10: Selects register space 0x100 to 0x17F 11: Selects register space 0x180 to 0x1FF

The device register map is larger than the address range directly addressable from the host interface. The page control register provides the higher address bits and control for using the paging mechanism. There are several copies of this register which are mirrored to addresses 0x080, 0x100 and 0x180.

A.1.2 Power Manager Control and Monitoring

Table 34: STATUS_A (0x001)

Field	Bit	Type	Description
Reserved	7:3	R	Reserved
DVC_BUSY	2:2	R	One or more DVC capable supplies are ramping
Reserved	1:1	R	Reserved
NONKEY	0:0	R	

Table 35: STATUS_B (0x002)

Field	Bit	Type	Description
Reserved	7:5	R	Reserved
GPI4	4:4	R	GPI4 level
GPI3	3:3	R	GPI3 level
GPI2	2:2	R	GPI2 level
GPI1	1:1	R	GPI1 level
GPI0	0:0	R	GPI0 level

PMIC for Applications Requiring up to 6 A

Table 36: STATUS_D (0x004)

Field	Bit	Type	Description
Reserved	7:4	R	Reserved
LDO4_ILIM	3:3	R	LDO4 over-current indicator
LDO3_ILIM	2:2	R	LDO3 over-current indicator
LDO2_ILIM	1:1	R	LDO2 over-current indicator
LDO1_ILIM	0:0	R	LDO1 over-current indicator

Table 37: FAULT_LOG (0x005)

Field	Bit	Type	Description
WAIT_SHUT	7:7	R Note 1	Power-down due to sequencer WAIT_STEP timeout, see Section 7.9.5.
NRESETREQ	6:6	R Note 1	Power-down due to nRESETREQ pin or control SHUTDOWN.
KEY_RESET	5:5	R Note 1	Power-down due to nONKEY.
TEMP_CRIT	4:4	R Note 1	Junction over-temperature
VDD_START	3:3	R Note 1	Power-down due to VSYS under-voltage before or within 16 s after release of nRESET.
VDD_FAULT	2:2	R Note 1	Power-down due to VSYS under-voltage ($V_{SYS} < V_{DD_FAULT_LOWER}$)
POR	1:1	R Note 1	DA9061 starts up from NO-POWER.
TWD_ERROR	0:0	R Note 1	Watchdog timeout

Note 1 Cleared from the host by writing back the read value.

A.1.3 IRQ Events

Table 38: EVENT_A (0x006)

Field	Bit	Type	Description
Reserved	7:7	R	Reserved
EVENTS_C	6:6	R	Event in register EVENT_C is active.
EVENTS_B	5:5	R	Event in register EVENT_B is active.
E_SEQ_RDY	4:4	R Note 1	Sequencer reached final position.
E_WDG_WARN	3:3	R Note 1	Watchdog timeout warning
Reserved	2:1		Reserved
E_NONKEY	0:0	R Note 1	nONKEY event

Note 1 Cleared from the host by writing back the read value.

PMIC for Applications Requiring up to 6 A

Table 39: EVENT_B (0x007)

Field	Bit	Type	Description
E_VDD_WARN	7:7	R Note 1	VSYS under-voltage ($V_{SYS} \leq V_{DD_FAULT_UPPER}$).
Reserved	6:6	R	Reserved
E_DVC_RDY	5:5	R Note 1	All supplies have finished DVC ramping.
Reserved	4:4	R	Reserved
E_LDO_LIM	3:3	R Note 1	Any LDO over-current
Reserved	2:2	R	Reserved
E_TEMP	1:1	R Note 1	Junction over-temperature ($T_J > T_{WARN}$)
Reserved	0:0		Reserved

Note 1 Cleared from the host by writing back the read value.

Table 40: EVENT_C (0x008)

Field	Bit	Type	Description
Reserved	7:5	R	Reserved
E_GPI4	4:4	R Note 1	GPI4 event
E_GPI3	3:3	R Note 1	GPI3 event
E_GPI2	2:2	R Note 1	GPI2 event
E_GPI1	1:1	R Note 1	GPI1 event
E_GPI0	0:0	R Note 1	GPI0event

Note 1 Cleared from the host by writing back the read value.

A.1.4 IRQ Masks

Table 41: IRQ_MASK_A (0x00A)

Field	Bit	Type	Description
Reserved	7:5		Reserved
M_SEQ_RDY	4:4	R/W	IRQ mask for sequencer final position indication (E_SEQ_RDY)
M_WDG_WARN	3:3	R/W	IRQ mask for watchdog timeout warning (E_WDG_WARN)
Reserved	2:1		Reserved
M_NONKEY	0:0	R/W	IRQ mask for nONKEY event (E_NONKEY)

Table 42: IRQ_MASK_B (0x00B)

Field	Bit	Type	Description
M_VDD_WARN	7:7	R/W	IRQ mask for under-voltage event (E_VDD_WARN) $V_{SYS} < V_{DD_FAULT_UPPER}$

PMIC for Applications Requiring up to 6 A

Reserved	6:6		Reserved
M_DVC_RDY	5:5	R/W	All supplies have finished DVC ramping.
Reserved	4:4		Reserved
M_LDO_LIM	3:3	R/W	IRQ mask for LDO over-current event (E_LDO_LIM)
Reserved	2:2		Reserved
M_TEMP	1:1	R/W	IRQ mask for junction over-temperature event (E_TEMP)
Reserved	0:0		Reserved

Table 43: IRQ_MASK_C (0x00C)

Field	Bit	Type	Description
Reserved	7:5		Reserved
M_GPI4	4:4	R/W	IRQ mask for GPI4 event (E_GPI4)
M_GPI3	3:3	R/W	IRQ mask for GPI3 event (E_GPI3)
M_GPI2	2:2	R/W	IRQ mask for GPI2 event (E_GPI2)
M_GPI1	1:1	R/W	IRQ mask for GPI1 event (E_GPI1)
M_GPI0	0:0	R/W	IRQ mask for GPI0 event (E_GPI0)

A.1.5 System Control

Table 44: CONTROL_A (0x00E)

Field	Bit	Type	Description
Reserved	7:7		Reserved
M_POWER1_EN	6:6	R/W	Write mask for POWER1_EN
M_POWER_EN	5:5	R/W	Write mask for POWER_EN
M_SYSTEM_EN	4:4	R/W	Write mask for SYSTEM_EN
STANDBY	3:3	R/W	Clearing control SYSTEM_EN or releasing SYS_EN (GPIO4 alternate function) or a long press of nONKEY will: 0: Power-down to slot 0. 1: Power-down as far as defined by the PART_DOWN pointer.
POWER1_EN	2:2	R/W	Target status of power domain POWER1. Bus write masked with M_POWER1_EN.
POWER_EN	1:1	R/W	Target status of power domain POWER. Bus write masked with M_POWER_EN.
SYSTEM_EN	0:0	R/W	Target status of power domain SYSTEM. Bus write masked with M_SYSTEM_EN.

Table 45: CONTROL_B (0x00F)

Field	Bit	Type	Description
BUCK_SLOWSTART	7:7	R/W	Enable buck slow start (reduced inrush current; increased start-up time).
NFREEZE	6:5	R/W	Block all wakeups after NFREEZE watchdog restart trials.
nONKEY_LOCK	4:4	R/W	0: normal POWERDOWN mode 1: Power-down controlled by KEY_DELAY

PMIC for Applications Requiring up to 6 A

NRES_MODE	3:3	R/W	If powering down / up: 0: Keep nRESET not asserted 1: Assert / clear nRESET when entering / leaving POWERDOWN
FREEZE_EN	2:2	R/W	Enable watchdog restart limit NFREEZE.
WATCHDOG_PD	1:1	R/W	Watchdog timer is on (1) / off (0) in POWERDOWN mode.
Reserved	0:0		Reserved

Table 46: CONTROL_C (0x010)

Field	Bit	Type	Description
DEF_SUPPLY	7:7	R/W	1: OTP enables / disables all supplies (except LDOCORE) when sequencer enters slot 0.
SLEW_RATE	6:5	R/W	Buck DVC slew rate step width [10 mV/step (20 mV/step for Buck2)] 00: 4 μ s for Buck1, Buck3; 8 μ s for Buck2 01: 2 μ s for Buck1, Buck3; 4 μ s for Buck2 10: 1 μ s for Buck1, Buck3; 2 μ s for Buck2 11: 0.5 μ s for Buck1, Buck3; 1 μ s for Buck2
OTPREAD_EN	4:4	R/W	When leaving POWERDOWN mode supplies are configured from OTP.
AUTO_BOOT	3:3	R/W	After progressing from RESET mode the sequencer... 0: ... requires a wakeup event to start-up. 1: ... starts up automatically.
DEBOUNCING	2:0	R/W	GPI, nONKEY and nRESETREQ debounce time 000: no debouncing 001: 0.1 ms 010: 1.0 ms 011: 10.24 ms 100: 51.2 ms 101: 256 ms 110: 512 ms 111: 1024 ms

Table 47: CONTROL_D (0x011)

Field	Bit	Type	Description
Reserved	7:3		Reserved
TWDSCALE	2:0	R/W	Watchdog timeout scaling 0: Watchdog disabled Other: Timeout = 2.048 * 2 ^(TWDSCALE-1) s

Table 48: CONTROL_E (0x012)

Field	Bit	Type	Description
V_LOCK	7:7	R/W	Prevent host from writing to registers 0x81 - 0x120 except 0x100.
Reserved	6:0		Reserved

PMIC for Applications Requiring up to 6 A

Table 49: CONTROL_F (0x013)

Field	Bit	Type	Description
Reserved	7:3		Reserved
WAKE_UP	2:2	R/W	Wake-up from POWERDOWN mode. Cleared automatically.
SHUTDOWN	1:1	R/W	Power down to RESET mode. Cleared automatically.
WATCHDOG	0:0	R/W	Reset watchdog timer. Cleared automatically.

Table 50: PD_DIS (0x014)

Field	Bit	Type	Description
PMCONT_DIS	7:7	R/W	Disable SYS_EN, PWR_EN and PWR1_EN in POWERDOWN mode.
Reserved	6:5		Reserved
CLDR_PAUSE	4:4	R/W	Disable calendar update in POWERDOWN mode.
Reserved	3:3		Reserved
PMIF_DIS	2:2	R/W	Disable 2-wire interface in POWERDOWN mode.
Reserved	1:1		Reserved
GPI_DIS	0:0	R/W	Disable E_GPI<x> events in POWERDOWN mode.

A.1.6 GPIO Control

Table 51: GPIO_0_1 (0x015)

Field	Bit	Type	Description
GPIO1_WEN	7:7	R/W	0: Passive-to-active transition triggers wakeup. 1: No wakeup
GPIO1_TYPE	6:6	R/W	GPI: active high (1) / low (0)
GPIO1_PIN	5:4	R/W	Function of GPIO1 pin (see GPIO1_OUT if output) 00: Reserved 01: Input (opt. regul. HW ctrl.) 10: Output (open-drain) 11: Output (push-pull)
GPIO0_WEN	3:3	R/W	0: Passive-to-active transition triggers wakeup. 1: No wakeup
GPIO0_TYPE	2:2	R/W	GPI: active high (1) / low (0)
GPIO0_PIN	1:0	R/W	Function of GPIO0 pin (see GPIO0_OUT if output) 00: Watchdog trigger input 01: Input 10: Output (open-drain) 11: Output (push-pull)

PMIC for Applications Requiring up to 6 A

Table 52: GPIO_2_3 (0x016)

Field	Bit	Type	Description
GPIO3_WEN	7:7	R/W	0: Passive-to-active transition triggers wakeup. 1: No wakeup
GPIO3_TYPE	6:6	R/W	GPI: active high (1) / low (0)
GPIO3_PIN	5:4	R/W	Function of GPIO3 pin (see GPIO3_OUT if output) 00: Reserved 01: Input (opt. regul. HW ctrl.) 10: Output (open-drain) 11: Output (push-pull)
GPIO2_WEN	3:3	R/W	0: Passive-to-active transition triggers wakeup. 1: No wakeup
GPIO2_TYPE	2:2	R/W	GPI: active high (1) / low (0)
GPIO2_PIN	1:0	R/W	Function of GPIO2 pin (see GPIO2_OUT if output) 00: GPI as PWR_EN 01: Input (opt. regul. HW ctrl.) 10: Output (open-drain) 11: nVDD_FAULT (push-pull)

Table 53: GPIO_4 (0x017)

Field	Bit	Type	Description
Reserved	7:4		Reserved
GPIO4_WEN	3:3	R/W	0: Passive-to-active transition triggers wakeup. 1: No wakeup
GPIO4_TYPE	2:2	R/W	GPI: active high (1) / low (0)
GPIO4_PIN	1:0	R/W	Function of GPIO pad (see GPIO4_OUT if output) 00: GPI as SYS_EN 01: Input 10: Output (open-drain) 11: Output (push-pull)

Table 54: GPIO_WKUP_MODE (0x01C)

Field	Bit	Type	Description
Reserved	7:5		Reserved
GPIO4_WKUP_MODE	4:4	R/W	GPI4 wakeup is edge (0) / level (1) sensitive.
GPIO3_WKUP_MODE	3:3	R/W	GPI3 wakeup is edge (0) / level (1) sensitive.
GPIO2_WKUP_MODE	2:2	R/W	GPI2 wakeup is edge (0) / level (1) sensitive.
GPIO1_WKUP_MODE	1:1	R/W	GPI1 wakeup is edge (0) / level (1) sensitive.
GPIO0_WKUP_MODE	0:0	R/W	GPI0 wakeup is edge (0) / level (1) sensitive.

PMIC for Applications Requiring up to 6 A

Table 55: GPIO_MODE0_4 (0x01D)

Field	Bit	Type	Description
Reserved	7:5		Reserved
GPIO4_MODE	4:4	R/W	Output, STATIC: the output value Output, other: active low (0) / high (1) Input: debouncing off (0) / on (1)
GPIO3_MODE	3:3	R/W	Output, STATIC: the output value Output, other: active low (0) / high (1) Input: debouncing off (0) / on (1)
GPIO2_MODE	2:2	R/W	Output, STATIC: the output value Output, other: active low (0) / high (1) Input: debouncing off (0) / on (1)
GPIO1_MODE	1:1	R/W	Output, STATIC: the output value Output, other: active low (0) / high (1) Input: debouncing off (0) / on (1)
GPIO0_MODE	0:0	R/W	Output, STATIC: the output value Output, other: active low (0) / high (1) Input: debouncing off (0) / on (1)

Table 56: GPIO_OUT0_2 (0x01E)

Field	Bit	Type	Description
GPIO2_OUT	7:6	R/W	GPIO output function 00: Static value according GPIO2_MODE 01: nVDD_FAULT 10: Reserved 11: Sequencer controlled
GPIO1_OUT	5:3	R/W	GPIO output function 000: Static value according GPIO1_MODE 001: nVDD_FAULT 010: Reserved 011: Sequencer controlled 100: Forward GPIO 101: Reserved 110: Forward GPI2 111: Forward GPI3
GPIO0_OUT	2:0	R/W	GPIO output function 000: Static value according GPIO0_MODE 001: nVDD_FAULT 010: Reserved 011: Sequencer controlled 100: Reserved 101: Forward GPI1 110: Forward GPI2 111: Forward GPI3

PMIC for Applications Requiring up to 6 A

Table 57: GPIO_OUT3_4 (0x01F)

Field	Bit	Type	Description
Reserved	7:5		Reserved
GPIO4_OUT	4:3	R/W	GPIO output function 00: Static value according GPIO4_MODE 01: nVDD_FAULT 10: Reserved 11: Sequencer controlled
GPIO3_OUT	2:0	R/W	GPIO output function 000: Static value according GPIO3_MODE 001: nVDD_FAULT 010: Reserved 011: Sequencer controlled 100: Forward GPIO 101: Forward GPI1 110: Forward GPI2 111: Reserved

A.1.7 Power Supply Control

Table 58: BUCK1_CONT (0x021)

Field	Bit	Type	Description
Reserved	7:7		Reserved
VBUCK1_GPI	6:5	R/W	Voltage controlling GPI (passive to active transition: VBUCK1_A, active to passive: VBUCK1_B) 00: Sequencer controlled 01: Select GPI1 10: Select GPI2 11: Select GPI3
Reserved	4:4		Reserved
BUCK1_CONF	3:3	R/W	Default supply, or sequenced and on in POWERDOWN
BUCK1_GPI	2:1	R/W	Enabling GPI (passive to active transition: enable, active to passive: disable) 00: Sequencer controlled 01: Select GPI1 10: Select GPI2 11: Select GPI3
BUCK1_EN	0:0	R/W	Disable (0) / enable (1) the buck (dependent on on/off priority order)

Table 59: BUCK3_CONT (0x022)

Field	Bit	Type	Description
Reserved	7:7		Reserved

PMIC for Applications Requiring up to 6 A

Field	Bit	Type	Description
VBUCK3_GPI	6:5	R/W	Voltage controlling GPI (passive to active transition: VBUCK3_A, active to passive: VBUCK3_B) 00: Sequencer controlled 01: Select GPI1 10: Select GPI2 11: Select GPI3
Reserved	4:4		Reserved
BUCK3_CONF	3:3	R/W	Default supply, or sequenced and on in POWERDOWN
BUCK3_GPI	2:1	R/W	Enabling GPI (passive to active transition: enable, active to passive: disable) 00: Sequencer controlled 01: Select GPI1 10: Select GPI2 11: Select GPI3
BUCK3_EN	0:0	R/W	Disable (0) / enable (1) the buck (dependent on on/off priority order)

Table 60: BUCK2_CONT (0x024)

Field	Bit	Type	Description
Reserved	7:7		Reserved
VBUCK2_GPI	6:5	R/W	Voltage controlling GPI (passive to active transition: VBUCK2_A, active to passive: VBUCK2_B) 00: Sequencer controlled 01: Select GPI1 10: Select GPI2 11: Select GPI3
Reserved	4:4		Reserved
BUCK2_CONF	3:3	R/W	Default supply, or sequenced and on in POWERDOWN
BUCK2_GPI	2:1	R/W	Enabling GPI (passive to active transition: enable, active to passive: disable) 00: Sequencer controlled 01: Select GPI1 10: Select GPI2 11: Select GPI3
BUCK2_EN	0:0	R/W	Disable (0) / enable (1) the buck (dependent on on/off priority order)

PMIC for Applications Requiring up to 6 A

Table 61: LDO1_CONT (0x026)

Field	Bit	Type	Description
LDO1_CONF	7:7	R/W	Default supply, or sequenced and on in POWERDOWN
VLDO1_GPI	6:5	R/W	Voltage controlling GPI (passive to active transition: VLDO1_A, active to passive: VLDO1_B) 00: Sequencer controlled 01: Select GPI1 10: Select GPI2 11: Select GPI3
Reserved	4:4		Reserved
LDO1_PD_DIS	3:3	R/W	0: Pull-down resistor enabled when the LDO is off 1: Pull-down resistor disabled when the LDO is off
LDO1_GPI	2:1	R/W	Enabling GPI (passive to active transition: enable, active to passive: disable) 00: Sequencer controlled 01: Select GPI1 10: Select GPI2 11: Select GPI3
LDO1_EN	0:0	R/W	Disable (0) / enable (1) the LDO (dependent on on/off priority order)

PMIC for Applications Requiring up to 6 A

Table 62: LDO2_CONT (0x027)

Field	Bit	Type	Description
LDO2_CONF	7:7	R/W	Default supply, or sequenced and on in POWERDOWN
VLDO2_GPI	6:5	R/W	Voltage controlling GPI (passive to active transition: VLDO2_A, active to passive: VLDO2_B) 00: Sequencer controlled 01: Select GPI1 10: Select GPI2 11: Select GPI3
Reserved	4:4		Reserved
LDO2_PD_DIS	3:3	R/W	0: Pull-down resistor enabled when the LDO is off 1: Pull-down resistor disabled when the LDO is off
LDO2_GPI	2:1	R/W	Enabling GPI (passive to active transition: enable, active to passive: disable) 00: Sequencer controlled 01: Select GPI1 10: Select GPI2 11: Select GPI3
LDO2_EN	0:0	R/W	Disable (0) / enable (1) the LDO (dependent on on/off priority order)

Table 63: LDO3_CONT (0x028)

Field	Bit	Type	Description
LDO3_CONF	7:7	R/W	Default supply, or sequenced and on in POWERDOWN
VLDO3_GPI	6:5	R/W	Voltage controlling GPI (passive to active transition: VLDO3_A, active to passive: VLDO3_B) 00: Sequencer controlled 01: Select GPI1 10: Select GPI2 11: Select GPI3
Reserved	4:4		Reserved
LDO3_PD_DIS	3:3	R/W	0: Pull-down resistor enabled when the LDO is off 1: Pull-down resistor disabled when the LDO is off
LDO3_GPI	2:1	R/W	Enabling GPI (passive to active transition: enable, active to passive: disable) 00: Sequencer controlled 01: Select GPI1 10: Select GPI2 11: Select GPI3
LDO3_EN	0:0	R/W	Disable (0) / enable (1) the LDO (dependent on on/off priority order)

PMIC for Applications Requiring up to 6 A

Table 64: LDO4_CONT (0x029)

Field	Bit	Type	Description
LDO4_CONF	7:7	R/W	Default supply, or sequenced and on in POWERDOWN
VLDO4_GPI	6:5	R/W	Voltage controlling GPI (passive to active transition: VLDO4_A, active to passive: VLDO4_B) 00: Sequencer controlled 01: Select GPI1 10: Select GPI2 11: Select GPI3
Reserved	4:4		Reserved
LDO4_PD_DIS	3:3	R/W	0: Pull-down resistor enabled when the LDO is off 1: Pull-down resistor disabled when the LDO is off
LDO4_GPI	2:1	R/W	Enabling GPI (passive to active transition: enable, act. to pas.: disable) 00: Sequencer controlled 01: Select GPI1 10: Select GPI2 11: Select GPI3
LDO4_EN	0:0	R/W	Disable (0) / enable (1) the LDO (dependent on on/off priority order)

Table 65: DVC_1 (0x032)

Field	Bit	Type	Description
VLDO4_SEL	7:7	R/W	Select VLDO4_A (0) / VLDO4_B (1).
VLDO3_SEL	6:6	R/W	Select VLDO3_A (0) / VLDO3_B (1).
VLDO2_SEL	5:5	R/W	Select VLDO2_A (0) / VLDO2_B (1).
VLDO1_SEL	4:4	R/W	Select VLDO1_A (0) / VLDO1_B (1).
VBUCK2_SEL	3:3	R/W	Select VBUCK2_A (0) / VBUCK2_B (1).
VBUCK3_SEL	2:2	R/W	Select VBUCK3_A (0) / VBUCK3_B (1).
Reserved	1:1		Reserved
VBUCK1_SEL	0:0	R/W	Select VBUCK1_A (0) / VBUCK1_B (1).

PMIC for Applications Requiring up to 6 A

A.2 PAGE 1

A.2.1 Power Sequencer

Table 66: SEQ (0x081)

Field	Bit	Type	Description
Reserved	7:4	R/W	Reserved
SEQ_POINTER	3:0	R	Actual power sequencer position

Table 67: SEQ_TIMER (0x082)

Field	Bit	Type	Description
SEQ_DUMMY	7:4	R/W	Waiting time for power sequencer slots which do not have an associated power supply. 0000: 32 μ s 0001: 64 μ s 0010: 96 μ s 0011: 128 μ s 0100: 160 μ s 0101: 192 μ s 0110: 224 μ s 0111: 256 μ s 1000: 288 μ s 1001: 384 μ s 1010: 448 μ s 1011: 512 μ s 1100: 1.024 ms 1101: 2.048 ms 1110: 4.096 ms 1111: 8.192 ms
SEQ_TIME	3:0	R/W	Length of each sequencer time slot 0000: 32 μ s 0001: 64 μ s 0010: 96 μ s 0011: 128 μ s 0100: 160 μ s 0101: 192 μ s 0110: 224 μ s 0111: 256 μ s 1000: 288 μ s 1001: 384 μ s 1010: 448 μ s 1011: 512 μ s 1100: 1.024 ms 1101: 2.048 ms 1110: 4.096 ms 1111: 8.192 ms

PMIC for Applications Requiring up to 6 A

Table 68: ID_2_1 (0x083)

Field	Bit	Type	Description
LDO2_STEP	7:4	R/W	Sequencer step for LDO2
LDO1_STEP	3:0	R/W	Sequencer step for LDO1

Table 69: ID_4_3 (0x084)

Field	Bit	Type	Description
LDO4_STEP	7:4	R/W	Sequencer step for LDO4
LDO3_STEP	3:0	R/W	Sequencer step for LDO3

Table 70: ID_12_11 (0x088)

Field	Bit	Type	Description
PD_DIS_STEP	7:4	R/W	Sequencer step for PD_DIS register functionality
Reserved	3:0	R/W	Reserved

Table 71: ID_14_13 (0x089)

Field	Bit	Type	Description
Reserved	7:4	R/W	Reserved
BUCK1_STEP	3:0	R/W	Sequencer step for Buck1

Table 72: ID_16_15 (0x08A)

Field	Bit	Type	Description
BUCK2_STEP	7:4	R/W	Sequencer step for Buck2
BUCK3_STEP	3:0	R/W	Sequencer step for Buck3

Table 73: ID_22_21 (0x08D)

Field	Bit	Type	Description
GP_FALL1_STEP	7:4	R/W	Sequencer step to de-assert GPO0
GP_RISE0_STEP	3:0	R/W	Sequencer step to assert GPO0

Table 74: ID_24_23 (0x08E)

Field	Bit	Type	Description
GP_FALL2_STEP	7:4	R/W	Sequencer step to de-assert GPO1
GP_RISE2_STEP	3:0	R/W	Sequencer step to assert GPO1

Table 75: ID_26_25 (0x08F)

Field	Bit	Type	Description
GP_FALL3_STEP	7:4	R/W	Sequencer step to de-assert GPO2
GP_RISE3_STEP	3:0	R/W	Sequencer step to assert GPO2

PMIC for Applications Requiring up to 6 A

Table 76: ID_28_27 (0x090)

Field	Bit	Type	Description
GP_FALL4_STEP	7:4	R/W	Sequencer step to de-assert GPO3
GP_RISE4_STEP	3:0	R/W	Sequencer step to assert GPO3

Table 77: ID_30_29 (0x091)

Field	Bit	Type	Description
GP_FALL5_STEP	7:4	R/W	Sequencer step to de-assert GPO4
GP_RISE5_STEP	3:0	R/W	Sequencer step to assert GPO4

Table 78: ID_32_31 (0x092)

Field	Bit	Type	Description
Reserved	7:4	R/W	Reserved
WAIT_STEP	3:0	R/W	Sequencer step for WAIT register functionality

Table 79: SEQ_A (0x095)

Field	Bit	Type	Description
POWER_END	7:4	R/W	End of POWER power domain in the sequencer SYSTEM_END <= POWER_END <= MAX_COUNT must be true.
SYSTEM_END	3:0	R/W	End of SYSTEM power domain in the sequencer PART_DOWN <= SYSTEM_END <= POWER_END must be true.

Table 80: SEQ_B (0x096)

Field	Bit	Type	Description
PART_DOWN	7:4	R/W	Sequencer slot to stop at, when going down into STANDBY state. 1 <= PART_DOWN <= SYSTEM_END must be true.
MAX_COUNT	3:0	R/W	End of POWER1 power domain in the sequencer POWER_END <= MAX_COUNT must be true.

PMIC for Applications Requiring up to 6 A

Table 81: WAIT (0x097)

Field	Bit	Type	Description
WAIT_DIR	7:6	R/W	WAIT_STEP power sequence selection 00: Do not wait during WAIT_STEP of power sequencer except for normal slot time. 01: Wait during up sequence. 10: Wait during down sequence. 11: Wait during up and down sequence.
TIME_OUT	5:5	R/W	Timeout when WAIT_MODE = 0 0: no timeout when waiting for external signal (GPIO3). 1: 500 ms timeout when waiting for external signal (GPIO3).
WAIT_MODE	4:4	R/W	0: Wait for external signal (GPIO3) to be active. 1: Start timer and wait for expiration.
WAIT_TIME	3:0	R/W	Wait timer during WAIT STEP of power sequencer ($\pm 10\%$) 0000: Do not wait during WAIT_STEP of power sequencer except for normal slot time. 0001: 512 μ s 0010: 1.0 ms 0011: 2.0 ms 0100: 4.1 ms 0101: 8.2 ms 0110: 16.4 ms 0111: 32.8 ms 1000: 65.5 ms 1001: 128 ms 1010: 256 ms 1011: 512 ms 1100: 1.0 s 1101: 2.0 s 1110: 4.1 s 1111: 8.2 s

PMIC for Applications Requiring up to 6 A

Table 82: RESET (0x099)

Field	Bit	Type	Description
RESET_EVENT	7:6	R/W	Reset timer started by: 00: EXT_WAKEUP 01: SYS_UP (register control or pin) 10: PWR_UP (register control or pin) 11: Leaving PMIC RESET mode
RESET_TIMER	5:0	R/W	0: Release nRESET immediately after the event selected by RESET_EVENT. 1 - 31: 1.024 ms * RESET_TIMER 32-63: 1.024 ms * 32 * (RESET_TIMER-31)

A.2.2 Power Supply Control

Table 83: BUCK_ILIM_A (0x09A)

Field	Bit	Type	Description
Reserved	7:4		Reserved
BUCK2_ILIM	3:0	R/W	Buck2 current limit = (1700 + BUCK2_ILIM * 100) mA

Table 84: BUCK_ILIM_B (0x09B)

Field	Bit	Type	Description
Reserved	7:4	R/W	Reserved
BUCK3_ILIM	3:0	R/W	Buck3 current limit = (700 + BUCK3_ILIM * 100) mA

Table 85: BUCK_ILIM_C (0x09C)

Field	Bit	Type	Description
Reserved	7:4	R/W	Reserved
BUCK1_ILIM	3:0	R/W	Buck1 current limit = (1400 + BUCK1_ILIM * 200) mA In half-current mode the limit is internally halved.

Table 86: BUCK1_CFG (0x09E)

Field	Bit	Type	Description
BUCK1_MODE	7:6	R/W	Controls the mode of the buck: 00: Controlled by BUCK1_SL_A and BUCK1_SL_B 01: Sleep (PFM) 10: Synchronous (PWM) 11: Automatic
BUCK1_PD_DIS	5:5	R/W	Disable pull-down resistor when disabled.
Reserved	4:1	R/W	Reserved
Reserved	0:0	R/W	Reserved

PMIC for Applications Requiring up to 6 A

Table 87: BUCK3_CFG (0x09F)

Field	Bit	Type	Description
BUCK3_MODE	7:6	R/W	Controls the mode of the buck: 00: Controlled by BUCK3_SL_A and BUCK3_SL_B 01: Sleep (PFM) 10: Synchronous (PWM) 11: Automatic
BUCK3_PD_DIS	5:5	R/W	Disable pull-down resistor when disabled.
Reserved	4:0	R/W	

Table 88: BUCK2_CFG (0x0A0)

Field	Bit	Type	Description
BUCK2_MODE	7:6	R/W	Controls the mode of the buck: 00: Controlled by BUCK3_SL_A and BUCK3_SL_B 01: Sleep (PFM) 10: Synchronous (PWM) 11: Automatic
BUCK2_PD_DIS	5:5	R/W	Disable pull-down resistor when disabled.
Reserved	4:0	R/W	Reserved

Table 89: VBUCK1_A (0x0A4)

Field	Bit	Type	Description
BUCK1_SL_A	7:7	R/W	This control is only effective when BUCK1_MODE = 0 0: forced to synchronous mode (PWM) when A setting is active. 1: forced to sleep mode (PFM) when A setting is active.
VBUCK1_A	6:0	R/W	From 0.3 V (0x00) to 1.57 V (0x7F) in steps of 10 mV

Table 90: VBUCK3_A (0x0A5)

Field	Bit	Type	Description
BUCK3_SL_A	7:7	R/W	This control is only effective when BUCK3_MODE = 0 0: forced to synchronous mode (PWM) when A setting is active. 1: forced to sleep mode (PFM) when A setting is active.
VBUCK3_A	6:0	R/W	From 0.53 V (0x00) to 1.8 V (0x7F) in steps of 10 mV

Table 91: VBUCK2_A (0x0A7)

Field	Bit	Type	Description
BUCK2_SL_A	7:7	R/W	This control is only effective when BUCK2_MODE = 0 0: forced to synchronous mode (PWM) when A setting is active. 1: forced to sleep mode (PFM) when A setting is active.
VBUCK2_A	6:0	R/W	From 0.80 V (0x00) to 3.34 V (0x7F) in steps of 20 mV

PMIC for Applications Requiring up to 6 A

Table 92: VLDO1_A (0x0A9)

Field	Bit	Type	Description
LDO1_SL_A	7:7	R/W	Force LDO sleep mode if VLDO1_A is active.
Reserved	6:6	R/W	Reserved
VLDO1_A	5:0	R/W	From 0.90 V (0x02) to 3.60 V (0x38) in steps of 50 mV Less than 0x02: 0.90 V; greater than 0x38: 3.60 V

Table 93: VLDO2_A (0x0AA)

Field	Bit	Type	Description
LDO2_SL_A	7:7	R/W	Force LDO sleep mode if VLDO2_A is selected.
Reserved	6:6	R/W	Reserved
VLDO2_A	5:0	R/W	From 0.90 V (0x02) to 3.60 V (0x38) in steps of 50 mV Less than 0x02: 0.90 V; greater than 0x38: 3.60 V

Table 94: VLDO3_A (0x0AB)

Field	Bit	Type	Description
LDO3_SL_A	7:7	R/W	Force LDO sleep mode if VLDO3_A is selected.
Reserved	6:6	R/W	Reserved
VLDO3_A	5:0	R/W	From 0.90 V (0x02) to 3.60 V (0x38) in steps of 50 mV Less than 0x02: 0.90 V; greater than 0x38: 3.60 V

Table 95: VLDO4_A (0x0AC)

Field	Bit	Type	Description
LDO4_SL_A	7:7	R/W	Force LDO sleep mode if VLDO4_A is selected.
Reserved	6:6	R/W	Reserved
VLDO4_A	5:0	R/W	From 0.90 V (0x02) to 3.60 V (0x38) in steps of 50 mV Less than 0x02: 0.90 V; greater than 0x38: 3.60 V

Table 96: VBUCK1_B (0x0B5)

Field	Bit	Type	Description
BUCK1_SL_B	7:7	R/W	This control is only effective when BUCK1_MODE = 0 0: forced to synchronous mode (PWM) when B setting is active. 1: forced to sleep mode (PFM) when B setting is active.
VBUCK1_B	6:0	R/W	From 0.3 V (0x00) to 1.57 V (0x7F) in steps of 10 mV

Table 97: VBUCK3_B (0x0B6)

Field	Bit	Type	Description
BUCK3_SL_B	7:7	R/W	This control is only effective when BUCK3_MODE = 0 0: forced to synchronous mode (PWM) when B setting is active. 1: forced to sleep mode (PFM) when B setting is active.
VBUCK3_B	6:0	R/W	From 0.53 V (0x00) to 1.8 V (0x7F) in steps of 10 mV

PMIC for Applications Requiring up to 6 A

Table 98: VBUCK2_B (0x0B8)

Field	Bit	Type	Description
BUCK2_SL_B	7:7	R/W	This control is only effective when BUCK2_MODE = 0 0: forced to synchronous mode (PWM) when B setting is active. 1: forced to sleep mode (PFM) when B setting is active.
VBUCK2_B	6:0	R/W	From 0.80 V (0x00) to 3.34 V (0x7F) in steps of 20 mV

Table 99: VLDO1_B (0x0BA)

Field	Bit	Type	Description
LDO1_SL_B	7:7	R/W	Force LDO sleep mode when B setting is active.
Reserved	6:6	R/W	Reserved
VLDO1_B	5:0	R/W	From 0.90 V (0x02) to 3.60 V (0x38) in steps of 50 mV Less than 0x02: 0.90 V; greater than 0x38: 3.60 V

Table 100: VLDO2_B (0x0BB)

Field	Bit	Type	Description
LDO2_SL_B	7:7	R/W	Force LDO sleep mode if VLDO2_B is selected.
Reserved	6:6	R/W	Reserved
VLDO2_B	5:0	R/W	From 0.90 V (0x02) to 3.60 V (0x38) in steps of 50 mV Less than 0x02: 0.90 V; greater than 0x38: 3.60 V

Table 101: VLDO3_B (0x0BC)

Field	Bit	Type	Description
LDO3_SL_B	7:7	R/W	Force LDO sleep mode if VLDO3_B is selected.
Reserved	6:6	R/W	Reserved
VLDO3_B	5:0	R/W	From 0.90 V (0x02) to 3.60 V (0x38) in steps of 50 mV Less than 0x02: 0.90 V; greater than 0x38: 3.60 V

Table 102: VLDO4_B (0x0BD)

Field	Bit	Type	Description
LDO4_SL_B	7:7	R/W	Force LDO sleep mode if VLDO4_B is selected.
Reserved	6:6	R/W	Reserved
VLDO4_B	5:0	R/W	From 0.90 V (0x02) to 3.60 V (0x38) in steps of 50 mV Less than 0x02: 0.90 V; greater than 0x38: 3.60 V

PMIC for Applications Requiring up to 6 A

A.3 PAGE 2

A.3.1 Customer Trim and Configuration

Table 103: INTERFACE (0x105)

Field	Bit	Type	Description
IF_BASE_ADDR	7:4	R Note 1	2-wire slave address MSBs. The LSBs of the slave address are "000". The complete slave address is then IF_BASE_ADDR * 23. However, the device also responds to IF_BASE_ADDR * 23+1.
Reserved	3:0		Reserved

Note 1 The interface configuration can be written/modified only for unmarked samples which do not have the control OTP_APPS_LOCK asserted/fused.

Table 104: CONFIG_A (0x106)

Field	Bit	Type	Description
Reserved	7:7	R	Reserved
PM_IF_HSM	6:6	R/W	2-wire interface permanently in high speed mode.
PM_IF_FMP	5:5	R/W	2-wire interface selects fast-mode+ timings.
PM_IF_V	4:4	R/W	2-wire supplied from VDDCORE (0) / VDDIO (1).
IRQ_TYPE	3:3	R/W	nIRQ is active low (0) / high (1).
PM_O_TYPE	2:2	R/W	nRESET and nIRQ are push pull (0) / open-drain (1).
Reserved	1:1	R/W	Reserved
PM_I_V	0:0	R/W	nRESETREQ, SYS_EN, PWR_EN and KEEPACT supplied from VDDCORE (0) / VDDIO (1).

Table 105: CONFIG_B (0x107)

Field	Bit	Type	Description
Reserved	7:7	R/W	Reserved
VDD_HYST_ADJ	6:4	R/W	nVDD_FAULT comparator hysteresis from 100 mV (0x0) to 450 mV (0x7) in 50 mV steps.
VDD_FAULT_ADJ	3:0	R/W	nVDD_FAULT comparator level from 2.5 V (0x0) to 3.25 V (0xF) in 50 mV steps.

Table 106: CONFIG_C (0x108)

Field	Bit	Type	Description
Reserved	7:7	R/W	Reserved
BUCK2_CLK_INV	6:6	R/W	Invert Buck2 clock polarity.
Reserved	5:5	R/W	Reserved
BUCK3_CLK_INV	4:4	R/W	Invert Buck3 clock polarity.
BUCK1_CLK_INV	3:3	R/W	Invert Buck1 clock polarity.
BUCK_ACTV_DISCHRG	2:2	R/W	Enable active discharging of buck rails.
Reserved	1:0	R/W	Reserved

PMIC for Applications Requiring up to 6 A

Table 107: CONFIG_D (0x109)

Field	Bit	Type	Description
Reserved	7:6	R/W	Reserved
FORCE_RESET	5:5	R/W	Keep nRESET always asserted
Reserved	4:3	R/W	Reserved
SYSTEM_EN_RD	2:2	R/W	Suppress loading SYSTEM_EN during OTP_RD2
NIRQ_MODE	1:1	R/W	nIRQ will be asserted from events during POWERDOWN ...
GPI_V	0:0	R/W	GPIs, except power manager controls, supplied from VDDCORE (0) / VDDIO (1).

Table 108: CONFIG_E (0x10A)

Field	Bit	Type	Description
Reserved	7:5	R/W	Reserved
BUCK2_AUTO	4:4	R/W	Enable and select VBUCK2_A when powering up
Reserved	3:3	R/W	Reserved
BUCK3_AUTO	2:2	R/W	Enable and select VBUCK3_A when powering up
Reserved	1:1	R/W	Reserved
BUCK1_AUTO	0:0	R/W	Enable and select VBUCK1_A when powering up

Table 109: CONFIG_G (0x10C)

Field	Bit	Type	Description
Reserved	7:4	R/W	Reserved
LDO4_AUTO	3:3	R/W	Enable and select VLDO4_A when powering up
LDO3_AUTO	2:2	R/W	Enable and select VLDO3_A when powering up
LDO2_AUTO	1:1	R/W	Enable and select VLDO2_A when powering up
LDO1_AUTO	0:0	R/W	Enable and select VLDO1_A when powering up

Table 110: CONFIG_H (0x10D)

Field	Bit	Type	Description
Reserved	7:7	R/W	Reserved
BUCK1_FCM	6:6	R/W	Buck full-current mode (double pass device and current limit).
Reserved	5:0	R/W	Reserved

PMIC for Applications Requiring up to 6 A

Table 111: CONFIG_I (0x10E)

Field	Bit	Type	Description
LDO_SD	7:7	R/W	Enable switching off an LDO if an over-current is detected longer than 200 ms.
INT_SD_MODE	6:6	R/W	Skip sequencer and dummy slots on shutdown from internal fault.
HOST_SD_MODE	5:5	R/W	Skip sequencer and dummy slots on shutdown from SHUTDOWN or nRESETREQ.
KEY_SD_MODE	4:4	R/W	Enable power-on reset on shutdown from nONKEY.
WATCHDOG_SD	3:3	R/W	Enable shutdown instead of power-down on watchdog timeout.
nONKEY_SD	2:2	R/W	Enable shutdown via long press of nONKEY.
NONKEY_PIN	1:0	R/W	nONKEY function, see Section 7.11

Table 112: CONFIG_J (0x10F)

Field	Bit	Type	Description
IF_RESET	7:7	R/W	Enable host interface reset via nRESETREQ pin
TWOWIRE_TO	6:6	R/W	Enable 35 ms timeout for 2-wire interfaces
RESET_DURATION	5:4	R/W	Minimum RESET mode duration: 00: 22 ms 01: 100 ms 10: 500 ms 11: 1 s
SHUT_DELAY	3:2	R/W	Shut down delay (+ KEY_DELAY) for nONKEY
KEY_DELAY	1:0	R/W	nONKEY locking threshold

Table 113: CONFIG_K (0x110)

Field	Bit	Type	Description
Reserved	7:5	R/W	Reserved
GPIO4_PUPD	4:4	R/W	GPI: pull-down enabled open-drain GPO: pull-up enabled
GPIO3_PUPD	3:3	R/W	GPI: pull-down enabled open-drain GPO: pull-up enabled
GPIO2_PUPD	2:2	R/W	GPI: pull-down enabled open drain GPO: pull-up enabled
GPIO1_PUPD	1:1	R/W	GPI: pull-down enabled open-drain GPO: pull-up enabled
GPIO0_PUPD	0:0	R/W	GPI: pull-down enabled open-drain GPO: pull-up enabled

PMIC for Applications Requiring up to 6 A

Table 114: CONFIG_M (0x112)

Field	Bit	Type	Description
OSC_FRQ	7:4	R/W	Adjust internal oscillator frequency: 1000: -10.67 % ... 1111: -1.33 % 0000: 0.00 % 0001: +1.33 % ... 0111: +9.33 %
WDG_MODE	3:3	R/W	Activate watchdog halt operation mode
Reserved	2:0	R/W	Reserved

A.3.2 Customer Device Specific

Table 115: GP_ID_0 (0x121)

Field	Bit	Type	Description
GP_0	7:0	R/W	General purpose register Note 1

Note 1 Initial value at start-up is the OTP ini file version number.

Table 116: GP_ID_1 (0x122)

Field	Bit	Type	Description
GP_1	7:0	R/W	General purpose register

Table 117: GP_ID_2 (0x123)

Field	Bit	Type	Description
GP_2	7:0	R/W	General purpose register

Table 118: GP_ID_3 (0x124)

Field	Bit	Type	Description
GP_3	7:0	R/W	General purpose register

Table 119: GP_ID_4 (0x125)

Field	Bit	Type	Description
GP_4	7:0	R/W	General purpose register

Table 120: GP_ID_5 (0x126)

Field	Bit	Type	Description
GP_5	7:0	R/W	General purpose register

Table 121: GP_ID_6 (0x127)

Field	Bit	Type	Description
GP_6	7:0	R/W	General purpose register

PMIC for Applications Requiring up to 6 A

Table 122: GP_ID_7 (0x128)

Field	Bit	Type	Description
GP_7	7:0	R/W	General purpose register

Table 123: GP_ID_8 (0x129)

Field	Bit	Type	Description
GP_8	7:0	R/W	General purpose register

Table 124: GP_ID_9 (0x12A)

Field	Bit	Type	Description
GP_9	7:0	R/W	General purpose register

Table 125: GP_ID_10 (0x12B)

Field	Bit	Type	Description
GP_10	7:0	R/W	General purpose register Note 1

Note 1 The value is persistent through a warm reset such as triggered by the nRESETREQ pin or by the SHUTDOWN control in register CONTROL_F.

Table 126: GP_ID_11 (0x12C)

Field	Bit	Type	Description
GP_11	7:0	R/W	General purpose register Note 1

Note 1 The value is persistent through a warm reset such as triggered by the nRESETREQ pin or by the SHUTDOWN control in register CONTROL_F.

Table 127: GP_ID_12 (0x12D)

Field	Bit	Type	Description
GP_12	7:0	R/W	General purpose register Note 1

Note 1 The value is persistent through a warm reset such as triggered by the nRESETREQ pin or by the SHUTDOWN control in register CONTROL_F.

Table 128: GP_ID_13 (0x12E)

Field	Bit	Type	Description
GP_13	7:0	R/W	General purpose register Note 1

Note 1 The value is persistent through a warm reset such as triggered by the nRESETREQ pin or by the SHUTDOWN control in register CONTROL_F.

Table 129: GP_ID_14 (0x12F)

Field	Bit	Type	Description
GP_14	7:0	R/W	General purpose register Note 1

Note 1 The value is persistent through a warm reset such as triggered by the nRESETREQ pin or by the SHUTDOWN control in register CONTROL_F.

Table 130: GP_ID_15 (0x130)

Field	Bit	Type	Description
GP_15	7:0	R/W	General purpose register Note 1

PMIC for Applications Requiring up to 6 A

Note 1 The value is persistent through a warm reset such as triggered by the nRESETREQ pin or by the SHUTDOWN control in register CONTROL_F.

Table 131: GP_ID_16 (0x131)

Field	Bit	Type	Description
GP_16	7:0	R/W	General purpose register Note 1

Note 1 The value is persistent through a warm reset such as triggered by the nRESETREQ pin or by the SHUTDOWN control in register CONTROL_F.

Table 132: GP_ID_17 (0x132)

Field	Bit	Type	Description
GP_17	7:0	R/W	General purpose register Note 1

Note 1 The value is persistent through a warm reset such as triggered by the nRESETREQ pin or by the SHUTDOWN control in register CONTROL_F.

Table 133: GP_ID_18 (0x133)

Field	Bit	Type	Description
GP_18	7:0	R/W	General purpose register Note 1

Note 1 The value is persistent through a warm reset such as triggered by the nRESETREQ pin or by the SHUTDOWN control in register CONTROL_F.

Table 134: GP_ID_19 (0x134)

Field	Bit	Type	Description
GP_19	7:0	R/W	General purpose register Note 2

Note 2 The value is persistent through a warm reset such as triggered by the nRESETREQ pin or by the SHUTDOWN control in register CONTROL_F.

PMIC for Applications Requiring up to 6 A

A.4 PAGE 3

A.4.1 Device Identification

Table 135: DEVICE_ID (0x181)

Field	Bit	Type	Description
DEV_ID	7:0	R	Device ID

Table 136: VARIANT_ID (0x182)

Field	Bit	Type	Description
MRC	7:4	R	Mask revision code
VRC	3:0	R/W	Chip variant code

Table 137: CUSTOMER_ID (0x183)

Field	Bit	Type	Description
CUST_ID	7:0	R	Customer ID

Table 138: CONFIG_ID (0x184)

Field	Bit	Type	Description
CONFIG_REV	7:0	R	OTP settings revision

PMIC for Applications Requiring up to 6 A

Status Definitions

Revision	Datasheet Status	Product Status	Definition
1.<n>	Target	Development	This datasheet contains the design specifications for product development. Specifications may be changed in any manner without notice.
2.<n>	Preliminary	Qualification	This datasheet contains the specifications and preliminary characterization data for products in pre-production. Specifications may be changed at any time without notice in order to improve the design.
3.<n>	Final	Production	This datasheet contains the final specifications for products in volume production. The specifications may be changed at any time in order to improve the design, manufacturing and supply. Major specification changes are communicated via Customer Product Notifications. Datasheet changes are communicated via www.dialog-semiconductor.com .
4.<n>	Obsolete	Archived	This datasheet contains the specifications for discontinued products. The information is provided for reference only.

RoHS Compliance

Dialog Semiconductor's suppliers certify that its products are in compliance with the requirements of Directive 2011/65/EU of the European Parliament on the restriction of the use of certain hazardous substances in electrical and electronic equipment. RoHS certificates from our suppliers are available on request.

IMPORTANT NOTICE AND DISCLAIMER

RENESAS ELECTRONICS CORPORATION AND ITS SUBSIDIARIES (“RENESAS”) PROVIDES TECHNICAL SPECIFICATIONS AND RELIABILITY DATA (INCLUDING DATASHEETS), DESIGN RESOURCES (INCLUDING REFERENCE DESIGNS), APPLICATION OR OTHER DESIGN ADVICE, WEB TOOLS, SAFETY INFORMATION, AND OTHER RESOURCES “AS IS” AND WITH ALL FAULTS, AND DISCLAIMS ALL WARRANTIES, EXPRESS OR IMPLIED, INCLUDING, WITHOUT LIMITATION, ANY IMPLIED WARRANTIES OF MERCHANTABILITY, FITNESS FOR A PARTICULAR PURPOSE, OR NON-INFRINGEMENT OF THIRD-PARTY INTELLECTUAL PROPERTY RIGHTS.

These resources are intended for developers who are designing with Renesas products. You are solely responsible for (1) selecting the appropriate products for your application, (2) designing, validating, and testing your application, and (3) ensuring your application meets applicable standards, and any other safety, security, or other requirements. These resources are subject to change without notice. Renesas grants you permission to use these resources only to develop an application that uses Renesas products. Other reproduction or use of these resources is strictly prohibited. No license is granted to any other Renesas intellectual property or to any third-party intellectual property. Renesas disclaims responsibility for, and you will fully indemnify Renesas and its representatives against, any claims, damages, costs, losses, or liabilities arising from your use of these resources. Renesas' products are provided only subject to Renesas' Terms and Conditions of Sale or other applicable terms agreed to in writing. No use of any Renesas resources expands or otherwise alters any applicable warranties or warranty disclaimers for these products.

(Disclaimer Rev.1.01 Jan 2024)

Corporate Headquarters

TOYOSU FORESIA, 3-2-24 Toyosu,
Koto-ku, Tokyo 135-0061, Japan
www.renesas.com

Trademarks

Renesas and the Renesas logo are trademarks of Renesas Electronics Corporation. All trademarks and registered trademarks are the property of their respective owners.

Contact Information

For further information on a product, technology, the most up-to-date version of a document, or your nearest sales office, please visit www.renesas.com/contact-us/.