

## HS3xxx-ML1

### High-Performance Relative Humidity and Temperature Sensor Module

The HS3xxx-ML1 series module enables quick application integration with a standard 4-pin header and fully calibrated relative humidity and temperature sensor (HS3xx1 and HS3xx3).

The HS310x relative humidity and temperature sensor features a hydrophobic membrane protecting it from environmental dusts, particles, and liquids with IP67 rating.

The HS3xxx-MCx has integrated calibration using a NIST traceable and verified production setup that is calibrated to ISO/IEC 17025 standards and temperature-compensation logic. This capability provides fully corrected RH and temperature values via a standard I<sup>2</sup>C output.

The HS3xxx series digital sensor accurately measures relative humidity and temperature levels. The measured data is internally corrected and compensated for accurate operation over a wide range of temperature and humidity levels – user calibration is not required.

The high accuracy, fast measurement response time, and long-term stability combined with the small package size make the HS3xxx ideal for a wide number of applications ranging from portable devices to products designed for harsh environments.

### Applications

- Climate control systems
- Home appliances
- Weather stations
- Industrial automation
- Medical equipment
- Automotive cabin climate control

### Product Image

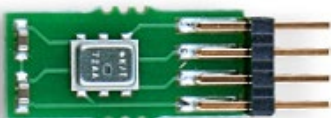

### Features

- Humidity range: 0% to 100% RH
- NIST traceability for relative humidity and temperature
- Hydrophobic membrane, IP67 rating (HS310x-ML1)
- Humidity accuracy: ±1.5% RH, typical (HS3xx1-ML1, 10 to 90% RH, 25°C)
- 14-bit resolution: 0.01% RH, typical
- Independent programmable resolution settings: 8, 10, 12, and 14 bits
- Fast RH response time: 1 second time constant, typical (with 1 m/sec air flow), 4 seconds time constant, typical (in still air)
- Temperature sensor accuracy: ±0.2°C, typical (HS3xx1-ML1, -10°C to +80°C)
- Low current consumption: 1.0µA average (8-bit resolution, 1.8V supply), 24.4µA average (14-bit resolution, 3.3V supply), one RH and temperature measurement per second
- Excellent stability against aging
- Highly robust protection from harsh environmental conditions and mechanical shock
- Very low power consumption

### Physical Characteristics

- Supply voltage: 2.3V to 5.5V
- Extended supply voltage: 1.8V (-20°C to +125°C, HS3xxx)
- Operating temperature (board): -20°C to +85°C
- 4-pin header, 0.050-inch (1.27mm) pitch
- Module: 14.9 × 5.28 × 2.46 mm (10.85 × 5.28 × 2.46 mm excluding pins)

## Contents

|   |           |
|---|-----------|
| <b>1. Pin Information</b>                         | <b>4</b>  |
| 1.1 Pin Assignments                               | 4         |
| 1.2 Pin Descriptions                              | 4         |
| 1.3 Pin Header                                    | 4         |
| 1.4 Functional Diagram                            | 5         |
| 1.5 Module Schematic                              | 5         |
| <b>2. Specifications</b>                          | <b>6</b>  |
| 2.1 Absolute Maximum Ratings                      | 6         |
| 2.2 Recommended Operating Conditions              | 6         |
| <b>3. Humidity and Temperature Specifications</b> | <b>7</b>  |
| 3.1 Humidity Sensor Specification                 | 7         |
| 3.2 Temperature Sensor Specification              | 8         |
| 3.3 Sleep Current                                 | 8         |
| 3.4 Humidity Sensor Accuracy Graphs               | 9         |
| 3.5 Temperature Sensor Accuracy Graphs            | 9         |
| <b>4. Conditioning</b>                            | <b>10</b> |
| <b>5. Application Circuit Example</b>             | <b>10</b> |
| <b>6. Sensor Interface</b>                        | <b>11</b> |
| 6.1 I <sup>2</sup> C Features and Timing          | 11        |
| 6.2 Sensor Slave Address                          | 12        |
| 6.3 I <sup>2</sup> C Communication                | 12        |
| 6.4 Measurement Mode                              | 12        |
| 6.5 Measurement Requests (MR)                     | 12        |
| 6.6 Data Fetch (DF)                               | 13        |
| 6.7 Calculating Humidity and Temperature Output   | 14        |
| 6.8 Status Bits                                   | 14        |
| 6.9 Accessing the Non-volatile Memory             | 15        |
| 6.10 Setting the Measurement Resolution           | 15        |
| 6.11 Reading the HS3xxx-ML1 ID Number             | 16        |
| <b>7. Storage and Handling</b>                    | <b>17</b> |
| <b>8. Quality and Reliability</b>                 | <b>17</b> |
| <b>9. Package Outline Drawings</b>                | <b>17</b> |
| <b>10. Ordering Information</b>                   | <b>17</b> |
| <b>11. Revision History</b>                       | <b>17</b> |

## Figures

|   |    |
|---|----|
| Figure 1. Functional Diagram of HS3xxx.....                                     | 5  |
| Figure 2. HS3xxx-ML1 PCB Schematic.....   | 5  |
| Figure 3. Sleep Current Variation over Temperature, $V_{DD}$ at 3.3V.....       | 8  |
| Figure 4. HS3xx1-ML1 RH Accuracy Tolerance at 25°C.....                         | 9  |
| Figure 5. HS3xx1-ML1 RH Accuracy over Temperature.....                          | 9  |
| Figure 6. HS3xx1-ML1 RH Accuracy over Temperature.....                          | 9  |
| Figure 7. HS3xx1-ML1 RH Accuracy over Temperature.....                          | 9  |
| Figure 8. HS3xx1-ML1 Temperature Sensor Accuracy Tolerance.....                 | 9  |
| Figure 9. HS3xx3-ML1 Temperature Sensor Accuracy Tolerance.....                 | 9  |
| Figure 10. HS3xxx-ML1 Application Circuit.....                                  | 10 |
| Figure 11. Timing Diagram.....  | 11 |
| Figure 12. START and STOP Condition Waveform.....                               | 12 |
| Figure 13. Measurement Request.....   | 13 |
| Figure 14. Data Fetch.....  | 14 |
| Figure 15. Sequence of Commands to Enter Programming Mode.....                  | 15 |
| Figure 16. Sequence of Commands to Change the Relative Humidity Resolution..... | 16 |

## Tables

|  |    |
|--|----|
| Table 1. Absolute Maximum Ratings.....   | 6  |
| Table 2. Recommended Operating Conditions.....   | 6  |
| Table 3. Humidity Sensor Specification, $T_A = +25^{\circ}\text{C}$ , $V_{DD} = 2.3\text{V}$ to 5.5V.....    | 7  |
| Table 4. Temperature Sensor Specification, $T_A = +25^{\circ}\text{C}$ , $V_{DD} = 2.3\text{V}$ to 5.5V..... | 8  |
| Table 5. I <sup>2</sup> C Timing Parameters.....   | 11 |
| Table 6. Status Bits.....  | 14 |
| Table 7. Non-volatile Memory Registers.....  | 15 |
| Table 8. Register Values for Different Resolution Settings.....  | 16 |

# 1. Pin Information

## 1.1 Pin Assignments

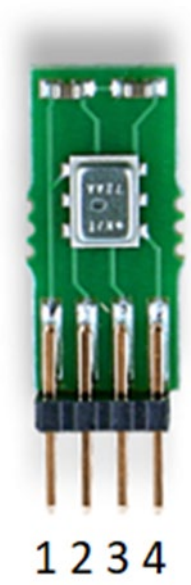

## 1.2 Pin Descriptions

| Pin Number | Pin Name | Type   | Description     |
|------------|----------|--------|-----------------|
| 1          | VDD      | In     | Supply voltage. |
| 2          | VSS      | In     | Ground.         |
| 3          | SDA      | In/Out | Serial data.    |
| 4          | SCL      | In/Out | Serial clock.   |

## 1.3 Pin Header

The straight 4-pin header contact center is 0.50-inch (1.27 mm). Part reference is Sullins, GRPB041VWVN-RC.

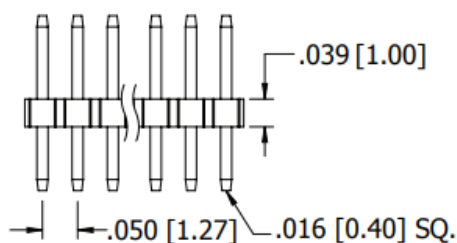

## 1.4 Functional Diagram

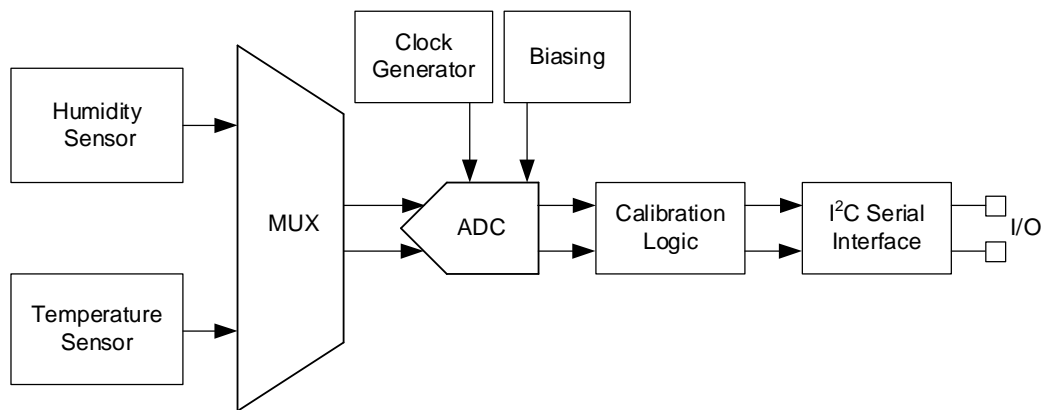

Figure 1. Functional Diagram of HS3xxx

## 1.5 Module Schematic

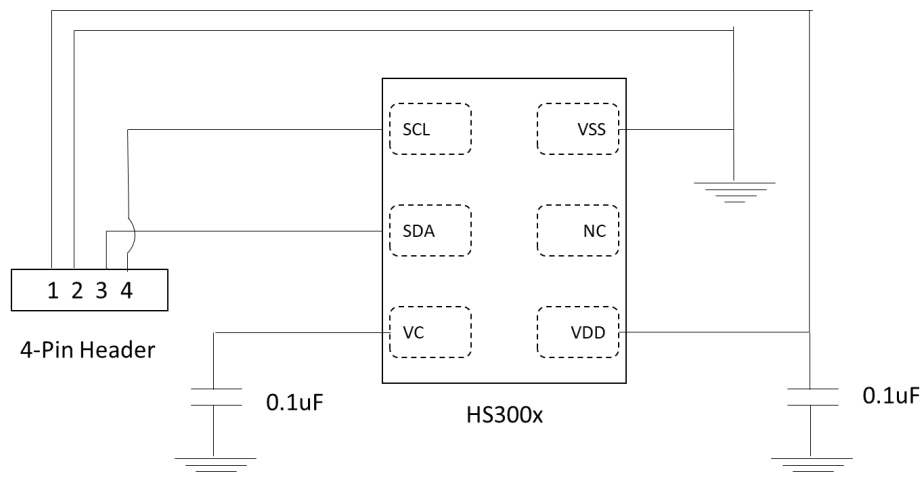

Figure 2. HS3xxx-ML1 PCB Schematic

## 2. Specifications

### 2.1 Absolute Maximum Ratings

**CAUTION:** Do not operate at or near the maximum ratings listed for extended periods of time. Exposure to such conditions can adversely impact product reliability and result in failures not covered by warranty.

**Table 1. Absolute Maximum Ratings**

| Symbol | Parameter                 | Conditions | Minimum | Maximum | Unit |
|--------|---------------------------|------------|---------|---------|------|
| -      | Analog Supply Voltage     | -          | -0.3    | 6.0     | V    |
| -      | Storage Temperature Range | -          | -55     | 125     | °C   |

### 2.2 Recommended Operating Conditions

Important note: The HS3xxx-ML1 series sensors are optimized to perform best in the more common temperature and humidity ranges of 10°C to 50°C and 20% RH to 80% RH, respectively. If operated outside of these conditions for extended periods, especially at high humidity levels, the sensors may exhibit an offset. In most cases, this offset is temporary and will gradually disappear once the sensor is returned to normal temperature and humidity conditions. The amount of the shift and the duration of the offset vary depending on the duration of exposure and the severity of the relative humidity and temperature conditions. The time needed for the offset to disappear can also be decreased by using the procedures described in “Conditioning”.

**Table 2. Recommended Operating Conditions**

| Parameter                         | Condition  |                   | Minimum | Typical | Maximum | Unit |
|-----------------------------------|--|-------------------|---------|---------|---------|------|
| Operating Supply Voltage          | -  |                   | 2.3     | 3.3     | 5.5     | V    |
| Extended Operating Supply Voltage | Operating temperature from -20 to 125°C                    |                   | 1.8     | -       | 5.5     | V    |
| Operating Humidity Range          | -  |                   | 0       | -       | 100     | %RH  |
| Operating Temperature, Sensor     | HS3xxx sensor only   |                   | -40     | -       | 125     | °C   |
| Operating Temperature, Board      | Limited to module connector                                |                   | -20     | -       | 85      | °C   |
| Sleep Current                     | Sleep Mode   | -40°C to 85°C     | -       | 0.6     | 1       | μA   |
|                                   |  | -40°C to 125°C    | -       | 1       | 3       |      |
| Average Current <sup>[1]</sup>    | One RH + temperature measurement/second                    | 8-bit resolution  | 1.0     | 1.5     | 1.7     | μA   |
|                                   |  | 10-bit resolution | 2.0     | 2.6     | 2.8     |      |
|                                   |  | 12-bit resolution | 5.5     | 7.0     | 7.1     |      |
|                                   |  | 14-bit resolution | 20.1    | 24.4    | 24.4    |      |
| Measurement Time                  | Wake-up  |                   | -       | 0.10    | -       | ms   |
|                                   | Humidity or temperature including the digital compensation | 8-bit resolution  | -       | 0.60    | -       |      |
|                                   |  | 10-bit resolution | -       | 1.40    | -       |      |
|                                   |  | 12-bit resolution | -       | 4.60    | -       |      |
|                                   |  | 14-bit resolution | -       | 17.00   | -       |      |

1. Minimum, typical, and maximum average currents are given at 1.8V, 3.3V, and 5.5V V<sub>DD</sub>, respectively.

### 3. Humidity and Temperature Specifications

#### 3.1 Humidity Sensor Specification

Table 3. Humidity Sensor Specification,  $T_A = +25^\circ\text{C}$ ,  $V_{DD} = 2.3\text{V}$  to  $5.5\text{V}$

| Parameter  | Condition                           |              | Minimum | Typical    | Maximum   | Unit   |
|--|-------------------------------------|--------------|---------|------------|-----------|--------|
| Operating Range                                    | -                                   |              | 0       | -          | 100       | %RH    |
| Accuracy <sup>[1]</sup>                            | HS3xx1-ML1                          | 10% to 90%RH | -       | $\pm 1.5$  | -         | %RH    |
|  | HS3xx3-ML1                          | 20% to 80%RH | -       | $\pm 2.5$  | -         |        |
| Resolution   | 8-bit                               |              | -       | 0.7        | -         | %RH    |
|  | 14-bit                              |              | -       | 0.01       | -         |        |
| Hysteresis   | -                                   |              | -       | -          | $\pm 1.0$ | %RH    |
| Noise in Humidity (RMS)                            | 14-bit                              |              | -       | 0.014      | -         | %RH    |
| Non-Linearity from Response Curve                  | HS3xx1-ML1                          | 10% to 90%RH | -       | $\pm 0.15$ | -         | %RH    |
|  | HS3xx3-ML1                          | 20% to 80%RH |         |            |           |        |
| Long-Term Stability                                | -                                   |              | -       | $\pm 0.1$  | -         | %RH/Yr |
| Response Time Constant <sup>[2]</sup> ( $\tau_H$ ) | 20% to 80% RH, 1 meter/sec air flow |              | -       | 1          | -         | sec    |
|  | 20% to 80% RH Still Air             |              | 3.0     | 4.0        | 6.0       |        |

1. Monotonic increases from 10 to 90%RH after sensor has been stabilized at 50% RH.
2. Initial value to 63% of total variation.

### 3.2 Temperature Sensor Specification

Table 4. Temperature Sensor Specification, T<sub>A</sub> = +25°C, V<sub>DD</sub> = 2.3V to 5.5V

| Parameter   | Condition         |               | Minimum | Typical | Maximum | Unit  |
|---|-------------------|---------------|---------|---------|---------|-------|
| Range   | -                 |               | -40     | -       | 125     | °C    |
| Accuracy  | HS3xx1-ML1        | -10°C to 80°C | -       | ±0.2    | -       | °C    |
|   | HS3xx3-ML1        | 0°C to 70°C   | -       | ±0.25   | -       |       |
| Resolution  | 8-bit             |               | -       | 0.9     | -       | °C    |
|   | 14-bit            |               | -       | 0.015   | -       |       |
| Response Time Constant <sup>[1]</sup> (τ <sub>r</sub> ) | -                 |               | 2..0    | -       |         | Sec.  |
| Long-Term Stability                                     | -                 |               | -       | -       | 0.02    | °C/Yr |
| Supply Voltage Dependency <sup>[2]</sup>                | VDD ≥ 2.8V        |               | -       | 0.03    | 0.1     | °C/V  |
|   | 1.8V < VDD < 2.8V |               | -       | 1.25    | 2.25    | °C/V  |

1. Response time depends on system thermal mass and air flow.
2. Temperature accuracy can be optimized for specified supply voltages upon request.

### 3.3 Sleep Current

The sleep current of the HS3xxx-ML1 series depends on the operating temperature, as shown in the following figure. Note that there is no significant dependence of the sleep current on the supply voltage.

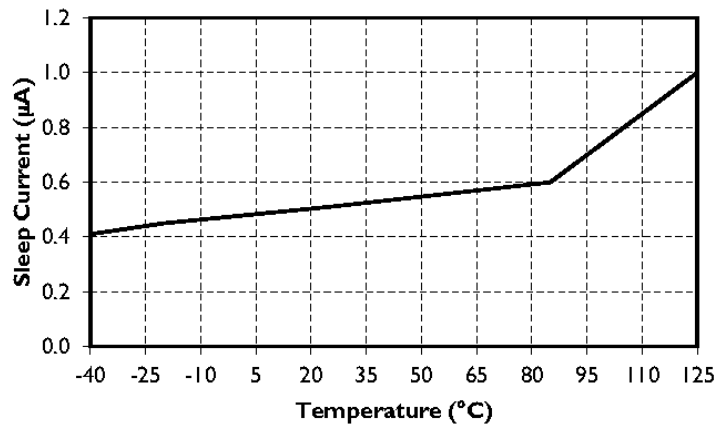

Figure 3. Sleep Current Variation over Temperature, V<sub>DD</sub> at 3.3V



### 3.4 Humidity Sensor Accuracy Graphs

The typical and maximum relative humidity sensor accuracy tolerances are shown in the following figures.

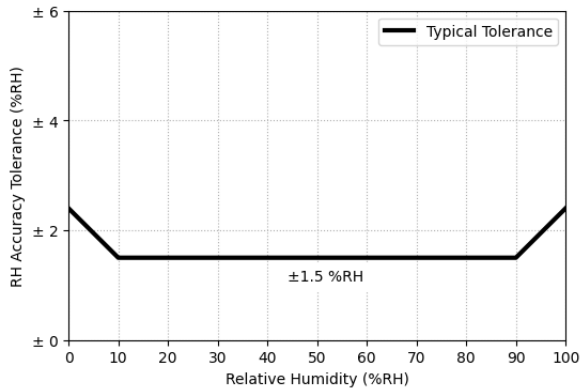

Figure 4. HS3xx1-ML1 RH Accuracy Tolerance at 25°C

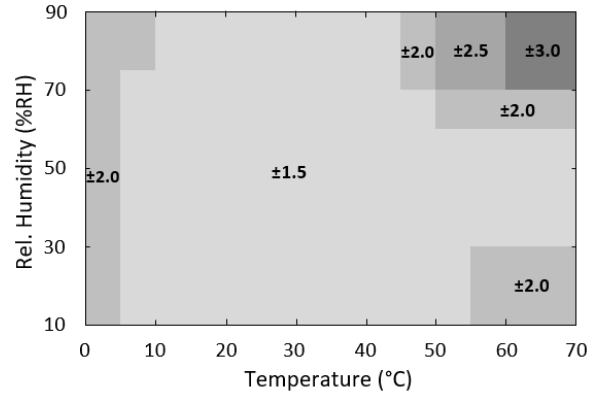

Figure 5. HS3xx1-ML1 RH Accuracy over Temperature

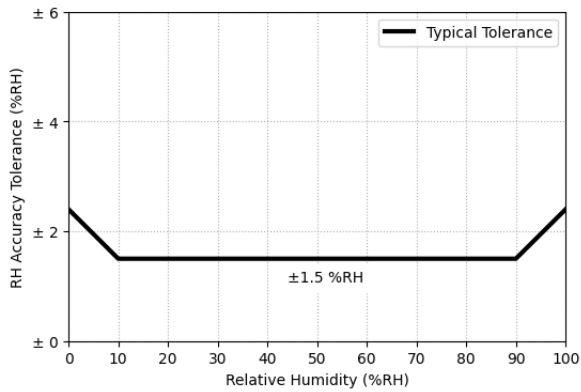

Figure 6. HS3xx1-ML1 RH Accuracy over Temperature

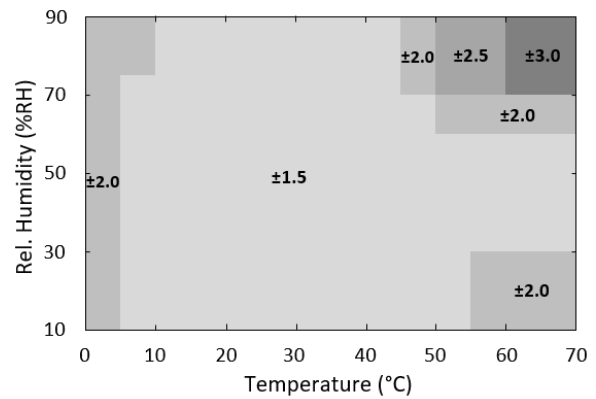

Figure 7. HS3xx1-ML1 RH Accuracy over Temperature

### 3.5 Temperature Sensor Accuracy Graphs

The typical and maximum temperature sensor accuracy tolerances are shown in the following figures.

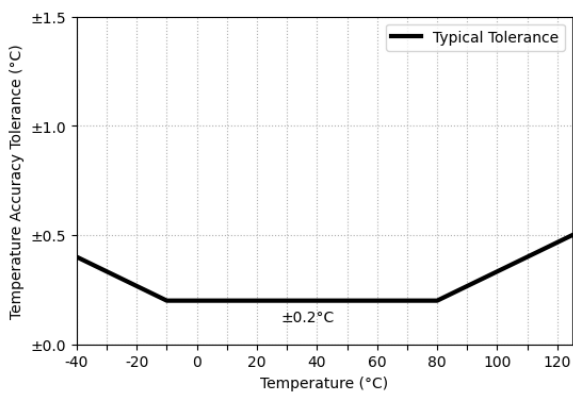

Figure 8. HS3xx1-ML1 Temperature Sensor Accuracy Tolerance

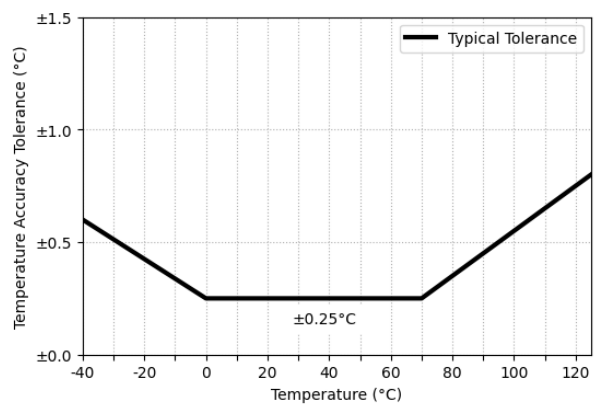

Figure 9. HS3xx3-ML1 Temperature Sensor Accuracy Tolerance

## 4. Conditioning

After prolonged storage outside the nominal storage conditions, a conditioning routine must be applied to ensure high sensor accuracy. If this routine is not followed then it will result in a slowly disappearing offset in the relative humidity readings.

Recommended rehydration process:

- A relative humidity of 75% RH at room temperature for at least 12 hours.  
or
- A relative humidity of 40% to 50% RH at room temperature for 3 to 5 days.

To avoid relative humidity reading offset after prolonged storage outside the recommendations listed in “Storage and Handling”, use the following procedure to recondition the humidity sensor.

1. Bake at a temperature of 85°C with a humidity < 10% RH for 14 to 16 hours.
2. Rehydrate the sensor at a humidity of 75% RH and a temperature between 20°C to 30°C for 12 to 14 hours.

## 5. Application Circuit Example

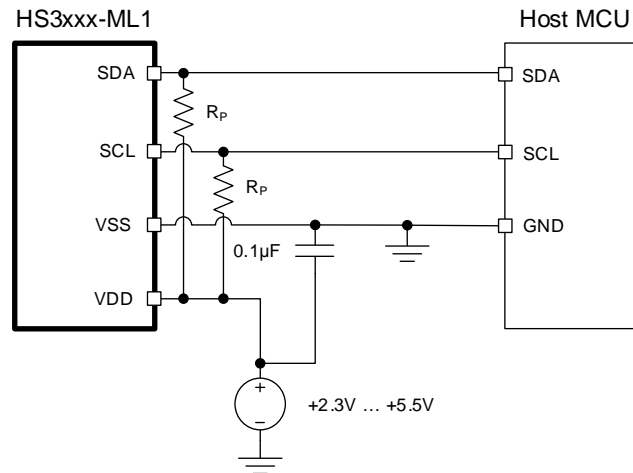

Figure 10. HS3xxx-ML1 Application Circuit

## 6. Sensor Interface

The HS3xxx-ML1 series sensor uses a digital I<sup>2</sup>C-compatible communication protocol. To accommodate multiple devices, the protocol uses two bi-directional open-drain lines: the Serial Data Line (SDA) and the Serial Clock Line (SCL). Pull-up resistors to V<sub>DD</sub> are required. Several slave devices can share the bus; however, only one master device can be present on the line.

### 6.1 I<sup>2</sup>C Features and Timing

The HS3xxx-ML1 series sensor operates as a slave device on the I<sup>2</sup>C bus with support for 100kHz and 400kHz bit rates. Each transmission is initiated when the master sends a 0 START bit (S), and the transmission is terminated when the master sends a 1 STOP bit (P). These bits are only transmitted while the SCL line is HIGH.

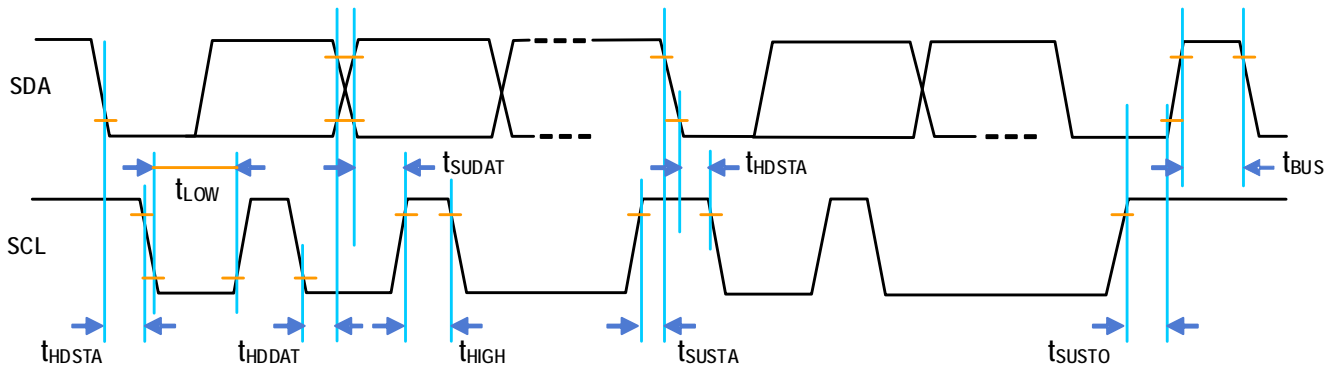

Figure 11. Timing Diagram

Table 5. I<sup>2</sup>C Timing Parameters

| Parameter  | Symbol             | Minimum | Typical | Maximum | Unit |
|--|--------------------|---------|---------|---------|------|
| SCL Clock Frequency <sup>[1]</sup>                       | f <sub>SCL</sub>   | 20      | -       | 400     | kHz  |
| START Condition Hold Time Relative to SCL Edge           | t <sub>HDSTA</sub> | 0.1     | -       | -       | μs   |
| Minimum SCL Clock LOW Width <sup>[2]</sup>               | t <sub>LOW</sub>   | 0.6     | -       | -       | μs   |
| Minimum SCL Clock HIGH Width <sup>[2]</sup>              | t <sub>HIGH</sub>  | 0.6     | -       | -       | μs   |
| START Condition Setup Time Relative to SCL Edge          | t <sub>SUSTA</sub> | 0.1     | -       | -       | μs   |
| Data Hold Time on SDA Relative to SCL Edge               | t <sub>HDDAT</sub> | 0       | -       | 0.5     | μs   |
| Data Setup Time on SDA Relative to SCL Edge              | t <sub>SUDAT</sub> | 0.1     | -       | -       | μs   |
| STOP Condition Setup Time on SCL                         | t <sub>SUSTO</sub> | 0.1     | -       | -       | μs   |
| Bus Free Time Between STOP Condition and START Condition | t <sub>BUS</sub>   | 1       | -       | -       | μs   |

1. The minimum frequency of 20kHz applies to test only; no minimum under normal operations.
2. Combined LOW and HIGH widths must equal or exceed the minimum SCL period.

## 6.2 Sensor Slave Address

The HS3xxx-ML1 series default I<sup>2</sup>C address is 44<sub>HEX</sub>. The device will respond only to this 7-bit address. For more information, see “I<sup>2</sup>C Communication.”

## 6.3 I<sup>2</sup>C Communication

The sensor transmission is initiated when the master sends a 0 START bit (S). The transmission is terminated when the master sends a 1 STOP bit (P). These bits are only transmitted while the SCL line is HIGH (see the following figure for waveforms).

When the START condition has been set, the SCL line is toggled at the prescribed data rate, clocking subsequent data transfers. Data on the SDA line is always sampled on the rising edge of the SCL line and must remain stable while SCL is HIGH to prevent false START or STOP conditions.

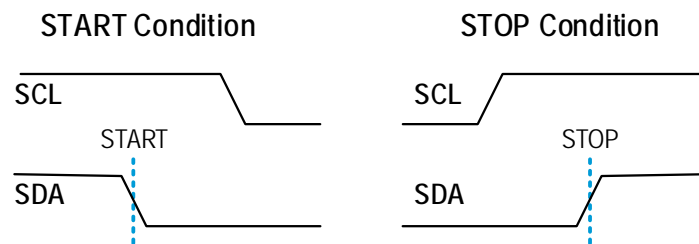

Figure 12. START and STOP Condition Waveform

After the START bit, the master device sends the 7-bit slave address (see “Sensor Slave Address”) to the HS3xxx-ML1, followed by the read/write bit, which indicates the transfer direction of any subsequent data. This bit is set to 1 to indicate a read from slave to master or set to 0 to indicate a write from master to slave.

All transfers consist of 8 bits and a response bit: 0 for Acknowledge (ACK) or 1 for Not Acknowledge (NACK). After the ACK is received, another data byte can be transferred, or the communication can be stopped, with a STOP bit.

## 6.4 Measurement Mode

The HS3xxx-ML1 is factory-programmed to operate in Sleep Mode. In Sleep Mode, the sensor waits for commands from the master before taking measurements. The digital core only performs conversions when it receives a *Measurement Request* command (MR); otherwise, it is always powered down.

## 6.5 Measurement Requests (MR)

The MR command is required to wake up the HS3xxx-ML1 from its Sleep Mode. Initiate the Measurement Request by sending the 7-bit slave address followed by an eighth bit = 0 (WRITE).

A measurement cycle consists of a humidity and temperature conversion followed by the digital signal processor (DSP) correction calculations. At the end of a measurement cycle, the digital output register will be updated before powering down.

The output is always scaled to 14 bits. The order of the bits is big-endian.

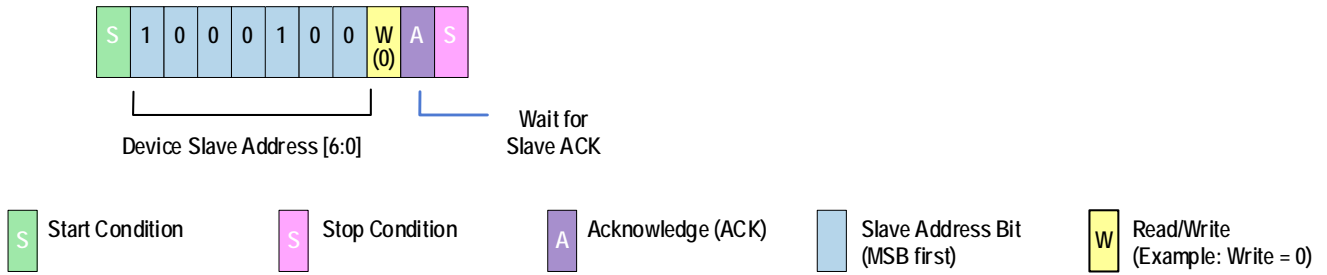

Figure 13. Measurement Request

## 6.6 Data Fetch (DF)

At the end of a measurement cycle, valid data can be fetched. The status bits of the DF results can be used to detect if the data is valid or stale (see “Calculating Humidity and Temperature Output”); otherwise, wait for the measurements to complete before performing the DF.

The DF command starts with the 7-bit slave address followed by an eighth bit = 1 (READ). The HS3xxx-ML1 as a slave sends an acknowledge (ACK) indicating success.

The number of data bytes returned by the HS3xxx-ML1 is determined by when the master sends the NACK and STOP condition. The full 14 bits of the humidity data are fetched in the first two bytes. The two MSBs of the first byte are the status bits.

The 14 bits of temperature data follow the humidity data. The last two bits (LSBs) of the fourth data byte are undetermined and should be masked off. In the event that the temperature data is not needed, the read can be terminated by sending a NACK after the second byte.

Alternatively, if only 8-bit resolution is desired for the temperature output, the read can be terminated after the 3<sup>rd</sup> byte by issuing a NACK followed by a stop bit. The measurement time depends on the configured sensor resolution. The following table lists examples when the resolutions for the relative humidity and temperature measurements are the same. For different relative humidity and temperature resolution settings, the measurement times in 3 should be used, along with the 0.1ms wake-up time.

For example, an 8-bit relative humidity measurement and a 12-bit temperature measurement results in a total measurement time of:

$$0.1\text{ms} + 0.6\text{ms} + 4.6\text{ms} = 5.3\text{ms}.$$

RH+T measurement times (including wake-up time) at different resolution settings.

| Resolution <sup>[1]</sup> (Bits) | Measurement Time (ms) |
|----------------------------------|-----------------------|
| 8                                | 1.2                   |
| 10                               | 2.8                   |
| 12                               | 9.2                   |
| 14                               | 34                    |

1. Same resolutions are assumed for both relative humidity and temperature.

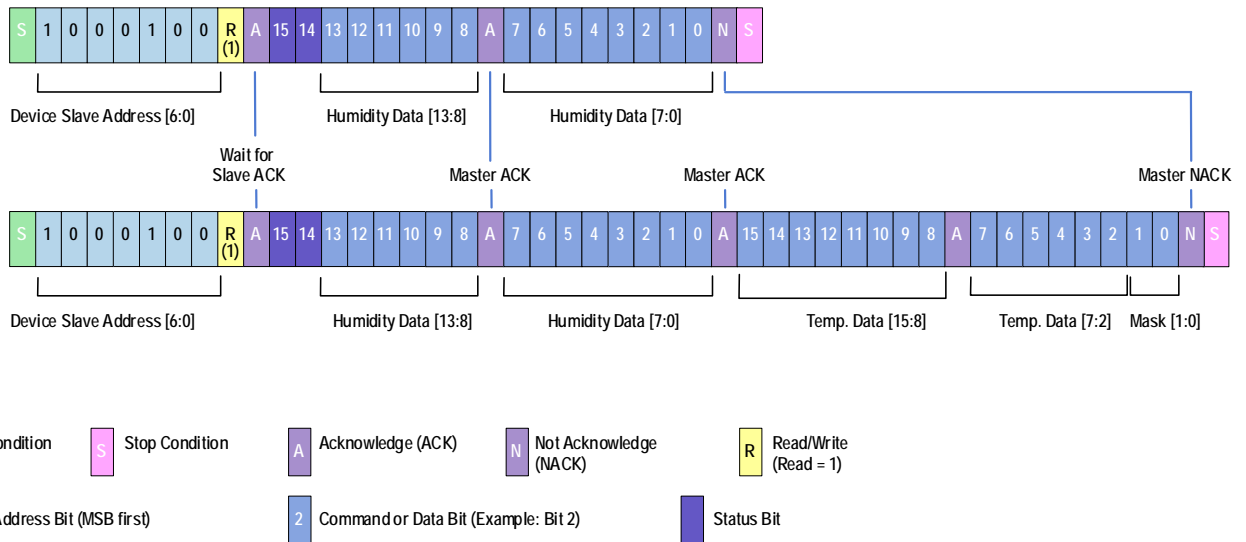

Figure 14. Data Fetch

### 6.7 Calculating Humidity and Temperature Output

The entire output of the HS3xxx-ML1 is 4 bytes. The relative humidity (in percent) and the temperature (in degrees Celsius) are calculated with Equation 1 and Equation 2, respectively.

$$Humidity [\%RH] = \left( \frac{Humidity [13 : 0]}{2^{14} - 1} \right) * 100 \tag{Equation 1}$$

$$Temperature [^{\circ}C] = \left( \frac{Temperature [15 : 2]}{2^{14} - 1} \right) * 165 - 40 \tag{Equation 2}$$

### 6.8 Status Bits

The status bits are used to indicate the current state of the fetched data. The two MSBs of the humidity data byte are the status bits (see the following table).

Table 6. Status Bits

| Status Bits     | Definition   |
|-----------------|--|
| 00 <sub>B</sub> | Valid Data: Data that has not been fetched since the last measurement cycle.   |
| 01 <sub>B</sub> | Stale Data: Data that has already been fetched since the last measurement cycle.<br><i>Note:</i> If a data fetch is performed before or during the first measurement after power-on reset, then the stale status will be returned, but this data is actually invalid since the first measurement has not been completed. |

## 6.9 Accessing the Non-volatile Memory

The HS3xxx-ML1 non-volatile memory stores its measurement resolution setting and its ID number. To change the sensor resolution or read the ID number, the master must place the HS3xxx-ML1 into programming mode while the device is powering up. The following figure shows the sequence of commands needed to enter the programming mode, which must be sent within 10ms after applying power to the sensor. The master must send the I<sup>2</sup>C address and a Write bit followed by the command **0xA0|0x00|0x00**.

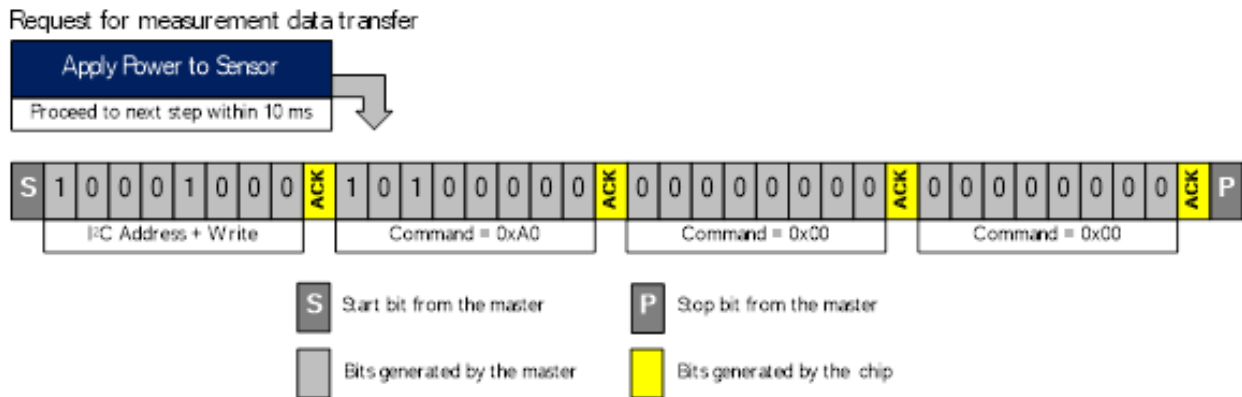

Figure 15. Sequence of Commands to Enter Programming Mode

This command takes 120µs to process, after which the master has access to the non-volatile memory registers listed in the following table. All of these registers are 16 bits wide.

To return to normal sensor operation and perform measurements, the master must send the I<sup>2</sup>C address and a Write bit, followed by the command: **0x80|0x00|0x00**.

Table 7. Non-volatile Memory Registers

| Address | Register Description   |
|---------|--|
| 0x06    | Humidity Sensor Resolution – Read Register (bits 11:10).     |
| 0x46    | Humidity Sensor Resolution – Write Register (bits 11:10).    |
| 0x11    | Temperature Sensor Resolution – Read Register (bits 11:10).  |
| 0x51    | Temperature Sensor Resolution – Write Register (bits 11:10). |
| 0x1E    | Read Sensor ID – Upper 2 bytes.                              |
| 0x1F    | Read Sensor ID – Lower 2 bytes.                              |

## 6.10 Setting the Measurement Resolution

The HS3xxx-ML1 relative humidity and temperature measurement resolutions can be set *independently* to 8, 10, 12, or 14-bits by writing to the non-volatile memory and are initially set to **14 bits by default**. The procedure to set the humidity sensor resolution is illustrated in the following figure. The relative humidity and temperature resolution can be read in registers **0x06 and 0x11**, respectively, or written in registers **0x46 or 0x51**. The resolution information is stored in bits [11:10] of these registers, as listed in Table 8. All of the other bits in these registers must be left unchanged. As such, before writing new resolution settings, the contents of the read registers must be read, and only bits [11:10] can be changed in the write registers. Once bits [11:10] are changed to set the desired resolution, *the entire register must be written back* to the HS3xxx-ML1 sensor.

**Step 1**

Write the register address



**Step 2**

Read the register contents

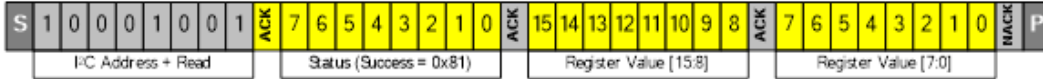

**Step 3**

Change bits [11:10] of the register to the desired resolution setting *without changing the other bits*

**Step 4**

Write the register contents back

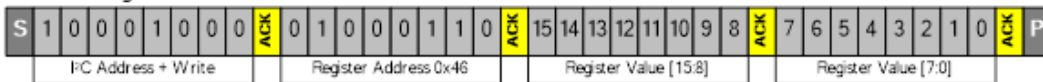

Figure 16. Sequence of Commands to Change the Relative Humidity Resolution

Table 8. Register Values for Different Resolution Settings

| Resolution Register Bits [11:10] | Resolution (Bits) |
|----------------------------------|-------------------|
| 00 <sub>B</sub>                  | 8                 |
| 01 <sub>B</sub>                  | 10                |
| 10 <sub>B</sub>                  | 12                |
| 11 <sub>B</sub>                  | 14                |

The sensor non-volatile memory requires 120µs to load the data into the registers after step 1 and requires 14ms to write the data after step 4. *Failure to comply with these processing times may result in data corruption and introduce errors in sensor measurements.* The procedure to change the temperature sensor resolution is the same as that displayed in Figure 14. Data Fetch, except the register address in Step 1 must be set to **0x11** and the register address in Step 4 will be **0x51**.

### 6.11 Reading the HS3xxx-ML1 ID Number

The sensor ID is a 32-bit number and can be read in a similar fashion as illustrated in steps 1 and 2 of Figure 15 using the appropriate register address values. The ID number is stored in two registers, with the upper and lower 16 bits stored in register addresses **0x1E** and **0x1F**, respectively.



## 7. Storage and Handling

*Recommendation:* Once the sensors are removed from their original packaging, store them in metal-in antistatic bags.

Avoid using polyethylene antistatic bags as they may affect sensor accuracy.

The nominal storage conditions are 10°C to 50°C and humidity levels within 20% to 60% RH. If stored outside of these conditions for extended periods of time, the sensor readings may exhibit an offset. The sensor can be reconditioned and brought back to its calibration state by applying the procedure described in section 4, Conditioning.

## 8. Quality and Reliability

The HS3xxx-ML1 series is available as a qualified product for consumer and industrial market applications. All data specified parameters are confirmed if not stated otherwise.

## 9. Package Outline Drawings

The package outline drawings are located at the end of this document and are accessible from the Renesas website (see Ordering Information for POD links). The package information is the most current data available and is subject to change without revision of this document.

## 10. Ordering Information

| Part Number | Description and Package   | Carrier Type | Temperature Range |
|-------------|---|--------------|-------------------|
| HS3001-ML1  | Digital Relative Humidity and Temperature Sensor.<br>±1.5% RH (typical), <a href="#">14.9 × 5.28 × 2.46 mm module</a>               | Tray         | -20°C to +85°C    |
| HS3101-ML1  | Digital Relative Humidity and Temperature Sensor with membrane.<br>±1.5% RH (typical), <a href="#">14.9 × 5.28 × 2.46 mm module</a> | Tray         | -20°C to +85°C    |
| HS3003-ML1  | Digital Relative Humidity and Temperature Sensor.<br>±2.5% RH (typical), <a href="#">14.9 × 5.28 × 2.46 mm module</a>               | Tray         | -20°C to +85°C    |
| HS3103-ML1  | Digital Relative Humidity and Temperature Sensor with membrane.<br>±2.5% RH (typical), <a href="#">14.9 × 5.28 × 2.46 mm module</a> | Tray         | -20°C to +85°C    |

## 11. Revision History

| Revision | Date        | Description      |
|----------|-------------|------------------|
| 1.00     | May 2, 2024 | Initial release. |

| HS310X-ML1 SERIES ASSEMBLY MODULE |            |
|-----------------------------------|------------|
| HS3101-ML1                        | HS3103-ML1 |

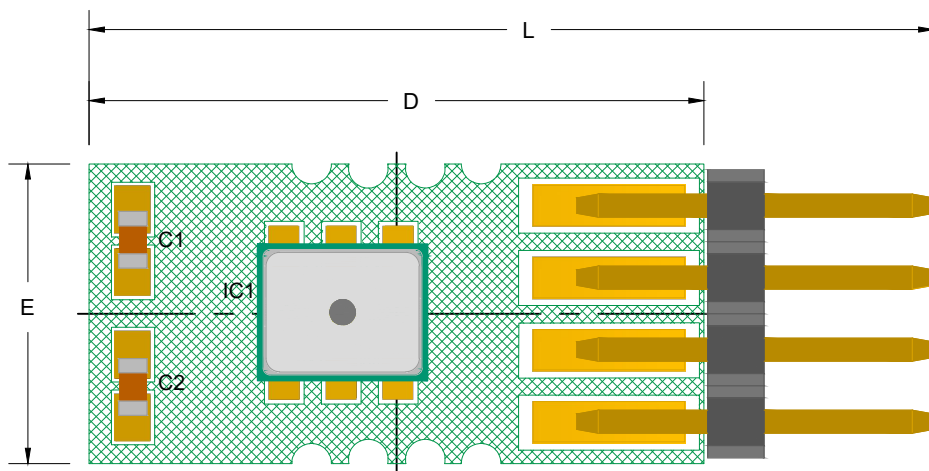

TOP VIEW



SIDE VIEW

Common Dimensions

|   | Min.  | Nom.  | Max.  |
|---|-------|-------|-------|
| D | 10.70 | 10.85 | 11.00 |
| E | 5.13  | 5.28  | 5.43  |
| L | 14.75 | 14.90 | 15.05 |
| H | 2.31  | 2.46  | 2.61  |
| t | 1.45  | 1.60  | 1.75  |

NOTES:

1. All dimension are in mm, angles in degrees.
2. Warpage shall not exceed 0.10mm.

## IMPORTANT NOTICE AND DISCLAIMER

RENESAS ELECTRONICS CORPORATION AND ITS SUBSIDIARIES (“RENESAS”) PROVIDES TECHNICAL SPECIFICATIONS AND RELIABILITY DATA (INCLUDING DATASHEETS), DESIGN RESOURCES (INCLUDING REFERENCE DESIGNS), APPLICATION OR OTHER DESIGN ADVICE, WEB TOOLS, SAFETY INFORMATION, AND OTHER RESOURCES “AS IS” AND WITH ALL FAULTS, AND DISCLAIMS ALL WARRANTIES, EXPRESS OR IMPLIED, INCLUDING, WITHOUT LIMITATION, ANY IMPLIED WARRANTIES OF MERCHANTABILITY, FITNESS FOR A PARTICULAR PURPOSE, OR NON-INFRINGEMENT OF THIRD-PARTY INTELLECTUAL PROPERTY RIGHTS.

These resources are intended for developers who are designing with Renesas products. You are solely responsible for (1) selecting the appropriate products for your application, (2) designing, validating, and testing your application, and (3) ensuring your application meets applicable standards, and any other safety, security, or other requirements. These resources are subject to change without notice. Renesas grants you permission to use these resources only to develop an application that uses Renesas products. Other reproduction or use of these resources is strictly prohibited. No license is granted to any other Renesas intellectual property or to any third-party intellectual property. Renesas disclaims responsibility for, and you will fully indemnify Renesas and its representatives against, any claims, damages, costs, losses, or liabilities arising from your use of these resources. Renesas' products are provided only subject to Renesas' Terms and Conditions of Sale or other applicable terms agreed to in writing. No use of any Renesas resources expands or otherwise alters any applicable warranties or warranty disclaimers for these products.

(Disclaimer Rev.1.01 Jan 2024)

### Corporate Headquarters

TOYOSU FORESIA, 3-2-24 Toyosu,  
Koto-ku, Tokyo 135-0061, Japan  
[www.renesas.com](http://www.renesas.com)

### Trademarks

Renesas and the Renesas logo are trademarks of Renesas Electronics Corporation. All trademarks and registered trademarks are the property of their respective owners.

### Contact Information

For further information on a product, technology, the most up-to-date version of a document, or your nearest sales office, please visit [www.renesas.com/contact-us/](http://www.renesas.com/contact-us/).