

ISL1536

Dual Channel Central Office ADSL2+ Line Driver

FN6508
Rev 4.00
February 15, 2013

The ISL1536 is a very low power dual channel differential amplifier designed for central office line driving for DMT ADSL2+. This device features a high drive capability of 400mA while consuming only 4mA of supply current per amplifier from ±12V supplies. It integrates gain and bias resistors while maintaining high slew rate and low distortion.

Ordering Information

PART NUMBER (Notes 1, 2, 3)	PART MARKING	TEMP. RANGE (°C)	PACKAGE (Pb-Free)	PKG. DWG. #
ISL1536IRZ	153 6IRZ	-40 to +85	16 Ld QFN	L16.4x4E
ISL1536IRZ-T13*	153 6IRZ	-40 to +85	16 Ld QFN	L16.4x4E

NOTES:

1. Please refer to [TB347](#) for details on reel specifications.
2. These Intersil Pb-free plastic packaged products employ special Pb-free material sets, molding compounds/die attach materials, and 100% matte tin plate plus anneal (e3 termination finish, which is RoHS compliant and compatible with both SnPb and Pb-free soldering operations). Intersil Pb-free products are MSL classified at Pb-free peak reflow temperatures that meet or exceed the Pb-free requirements of IPC/JEDEC J STD-020.
3. For Moisture Sensitivity Level (MSL), please see device information page for [ISL1536](#). For more information on MSL, please see tech brief [TB363](#).

Features

- Internal Fixed Gain $A_V = 12.85$
- Integrated Feedback Resistors
- 43.4V_{P-P} Differential Output Drive into 100Ω
- 41.6V_{P-P} Minimum Differential Output Drive into 60Ω
- -59dBc Typical Driver Output Distortion Driving 50Ω at 2MHz
- Low Quiescent Current of 3mA per Amplifier
- Power-Down Disable Control
- Pb-Free (RoHS Compliant)

Applications

- ADSL, ADSL2, ADSL2+ Line Drivers
- G.SHDSL, HDSL2 Line Drivers
- Video Distribution Amplifiers
- Video Twisted-pair Line Drivers

Pinout

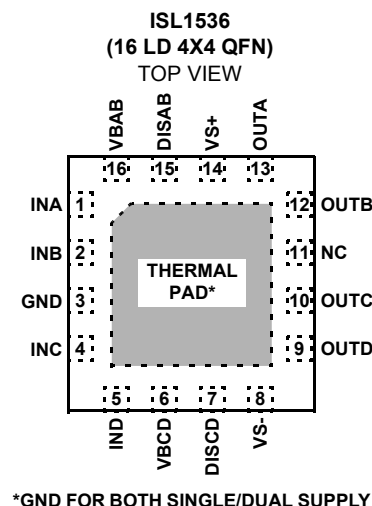

Block Diagram

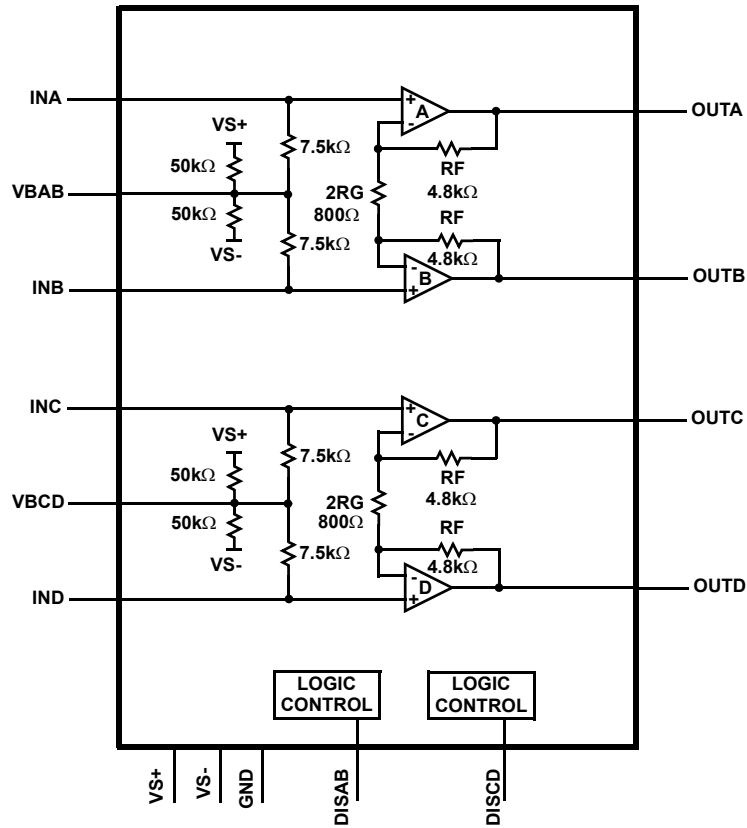

Pin Descriptions

16 LD QFN	PIN NAME	FUNCTION
1	INA	Amplifier A input
2	INB	Amplifier B input
3	GND	Ground connection
4	INC	Amplifier C input
5	IND	Amplifier D input
6	VBCD	Voltage bias for amplifier C, D
7	DISCD	Enable/disable amplifiers C, D (DSL Channel #2)
8	VS-	Negative supply
9	OUTD	Amplifier D output
10	OUTC	Amplifier C output
11	NC	No internal connection. Connect to GND on PCB.
12	OUTB	Amplifier B output
13	OUTA	Amplifier A output
14	VS+	Positive supply
15	DISAB	Enable/disable amplifiers A, B (DSL Channel #1).
16	VBAB	Voltage bias for amplifier A, B

Absolute Maximum Ratings ($T_A = +25^\circ\text{C}$)

V_{S+} to V_{S-} Supply Voltage	30V
V_{S+} Voltage to Ground	-0.3V to +30V
V_{S-} Voltage to Ground	-30V to 0.3V
Input DISAB, DISCD to Ground	.7V
V_{IN+} Voltage	V_{S-} to V_{S+}
Current into any Input	8mA
Continuous Output Current	75mA
ESD Rating	
Human Body Model	.4kV
Machine Model	.250V

Thermal Information

Thermal Resistance (Typical, Note 4)	θ_{JA} ($^\circ\text{C}/\text{W}$)
16 Lead QFN	40
Ambient Operating Temperature Range	-40°C to $+85^\circ\text{C}$
Storage Temperature Range	-60°C to $+150^\circ\text{C}$
Operating Junction Temperature	$+150^\circ\text{C}$
Power Dissipation	See curves
Pb-Free Reflow Profile	see link below
	http://www.intersil.com/pbfree/Pb-FreeReflow.asp

CAUTION: Do not operate at or near the maximum ratings listed for extended periods of time. Exposure to such conditions may adversely impact product reliability and result in failures not covered by warranty.

NOTE:

4. θ_{JA} is measured with the component mounted on a high effective thermal conductivity test board in free air. See Tech Brief [TB379](#) for details.

IMPORTANT NOTE: All parameters having Min/Max specifications are guaranteed. Typ values are for information purposes only. Unless otherwise noted, all tests are at the specified temperature and are pulsed tests, therefore: $T_J = T_C = T_A$

Electrical Specifications $V_S = \pm 12\text{V}$, $R_L = 50\Omega$ to GND, DISAB = DISCD = 0, $T_A = +25^\circ\text{C}$, unless otherwise specified.

PARAMETER	DESCRIPTION	CONDITIONS	MIN (Note 5)	TYP	MAX (Note 5)	UNIT
AC PERFORMANCE						
A_V	Gain		12.6	12.85	13.1	V/V
BW	-3dB Bandwidth			50		MHz
THD	Total Harmonic Distortion	$f = 1\text{MHz}$, $V_O = 10V_{O_{P-P}}$ - diff, $R_L = 50\Omega$ to GND		-69		dBc
		$f = 2.2\text{MHz}$, $V_O = 10V_{O_{P-P}}$ - diff, $R_L = 50\Omega$ to GND		-59		dBc
SR	Slew Rate, Single-Ended Signal	V_{OUT} from -4.5V to $+4.5\text{V}$	200	400		V/ μs
DC PERFORMANCE						
V_{OS-DM}	Differential Mode Offset Voltage		-50		+50	mV
V_{OS-CM}	Common Mode Offset Voltage		-125		125	mV
INPUT CHARACTERISTICS						
I_{B+}	Non-Inverting Input Bias Current		-5		+5	μA
e_N	Input Noise Voltage	$f = 10\text{kHz}$		8.0		nV/ $\sqrt{\text{Hz}}$
i_{N+}	+Input Noise Current	$f = 10\text{kHz}$		1.0		pA/ $\sqrt{\text{Hz}}$
RIN	Input Resistance		6	7.5	9	k Ω
V_{IH}	Input High Voltage	DIS inputs	2.2			V
V_{IL}	Input Low Voltage	DIS inputs			0.8	V
I_{IH}	Input High Current for DIS	DIS = 5V	20	58	100	μA
I_{IL}	Input Low Current for DIS	DIS = 0V	-25	-7	0	μA
OUTPUT CHARACTERISTICS						
V_{OUT-50}	Loaded Output Swing Single-Ended	$R_L = 50\Omega$ to GND	± 10.4	± 10.85		V
V_{OUT-30}	Loaded Output Swing Single-Ended	$R_L = 30\Omega$ to GND	± 9.8	± 10.4		V
$V_{OUT-DIS}$	Disable Output Voltage				± 800	mV
I_{OUT}	Output Current	$R_L = 0\Omega$		600		mA

Electrical Specifications $V_S = \pm 12V$, $R_L = 50\Omega$ to GND, DISAB = DISCD = 0, $T_A = +25^\circ C$, unless otherwise specified. (Continued)

PARAMETER	DESCRIPTION	CONDITIONS	MIN (Note 5)	TYP	MAX (Note 5)	UNIT
SUPPLY CHARACTERISTICS						
$V_{S(MAX)}$	Maximum Operating Supply Voltage			± 13.2		V
$V_{S(MIN)}$	Minimum Operating Supply Voltage			± 7.5		V
I_{S^+} (Enable)	Positive Supply Current per Amplifier	All outputs at 0V, DIS = 0V		4.0	5	mA
I_{S^-} (Enable)	Negative Supply Current per Amplifier	All outputs at 0V, DIS = 0V	-4.85	-3.9		mA
I_{S^+} (Power Down)	Positive Supply Current per Amplifier	All outputs at 0V, DIS = 5V		0.3	0.75	mA
I_{S^-} (Power Down)	Negative Supply Current per Amplifier	All outputs at 0V, DIS = 5V	-0.75	0		mA
I_{GND}	GND Supply Current per Amplifier	All outputs at 0V		0.3		mA

NOTE:

- 5. Compliance to datasheet limits is assured by one or more methods: production test, characterization and/or design.

Typical Performance Curves

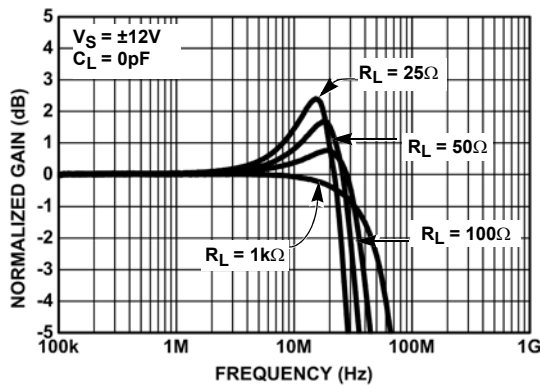

FIGURE 1. DIFFERENTIAL FREQUENCY RESPONSE vs R_L

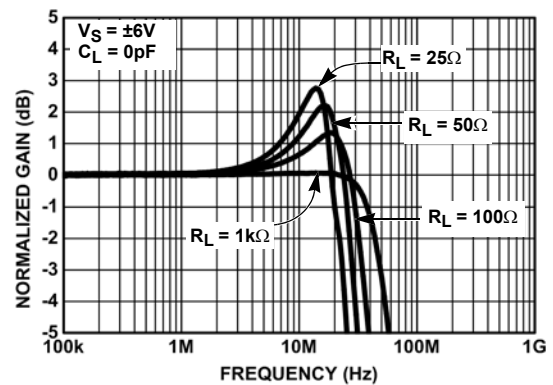

FIGURE 2. DIFFERENTIAL FREQUENCY RESPONSE vs R_L

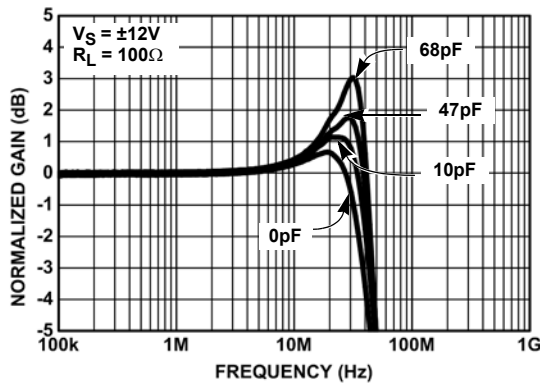

FIGURE 3. DIFFERENTIAL FREQUENCY RESPONSE vs C_L

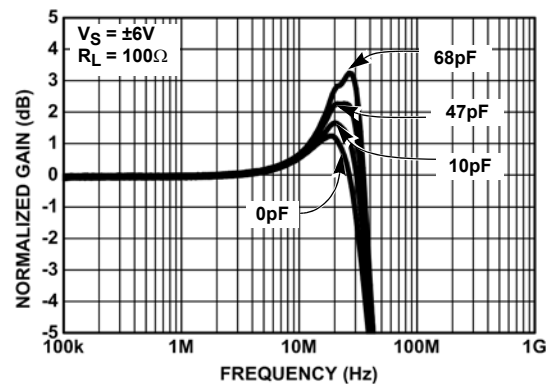

FIGURE 4. DIFFERENTIAL FREQUENCY RESPONSE vs C_L

Typical Performance Curves (Continued)

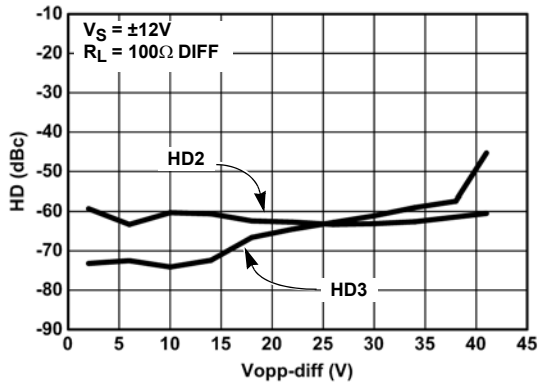

FIGURE 5. 200kHz 2ND AND 3RD HARMONICS vs DIFFERENTIAL OUTPUT VOLTAGE

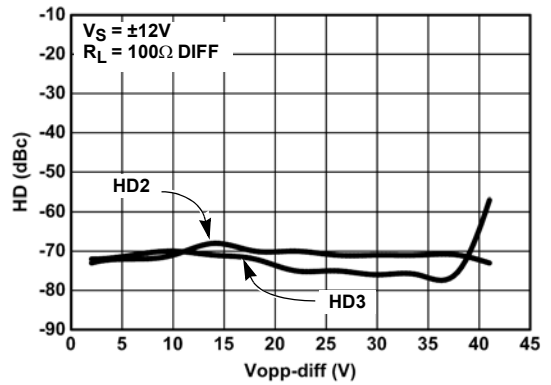

FIGURE 6. 1MHz 2ND AND 3RD HARMONICS vs DIFFERENTIAL OUTPUT VOLTAGE

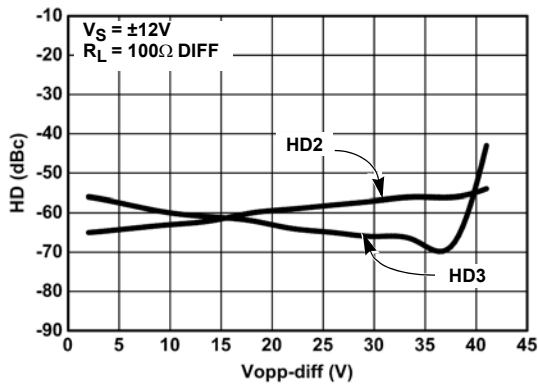

FIGURE 7. 2.2MHz 2ND AND 3RD HARMONICS vs DIFFERENTIAL OUTPUT VOLTAGE

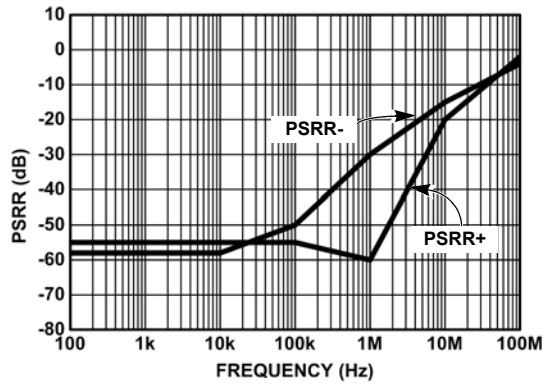

FIGURE 8. PSRR vs FREQUENCY

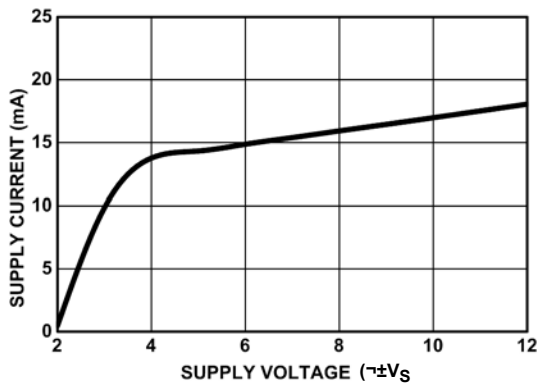

FIGURE 9. SUPPLY CURRENT vs SUPPLY VOLTAGE (ALL AMPLIFIERS ENABLED)

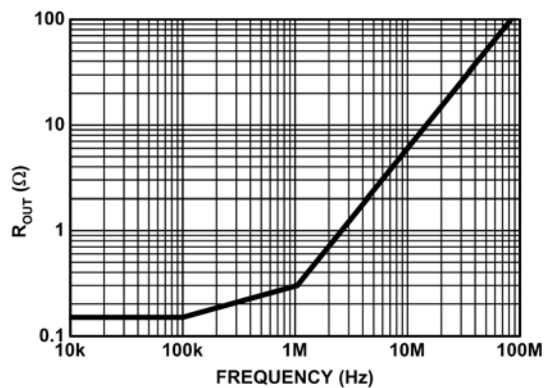

FIGURE 10. OUTPUT IMPEDANCE vs FREQUENCY

Typical Performance Curves (Continued)

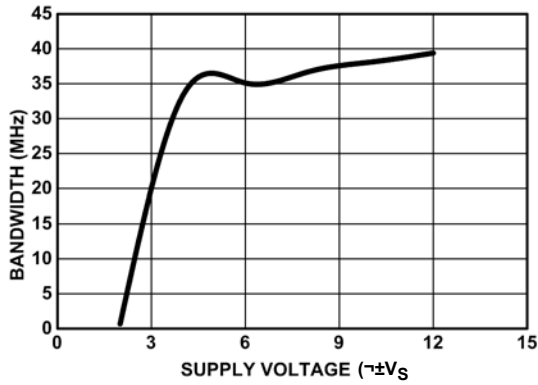

FIGURE 11. DIFFERENTIAL 3dB BANDWIDTH vs SUPPLY VOLTAGE

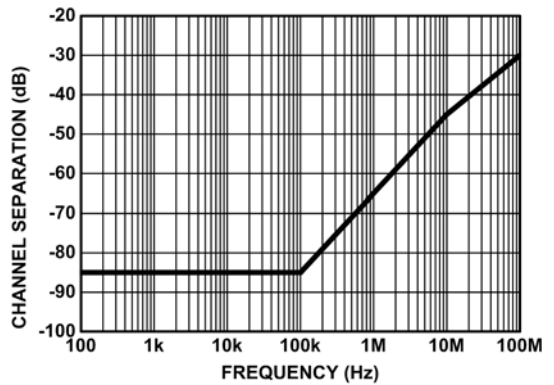

FIGURE 12. CHANNEL SEPARATION vs FREQUENCY

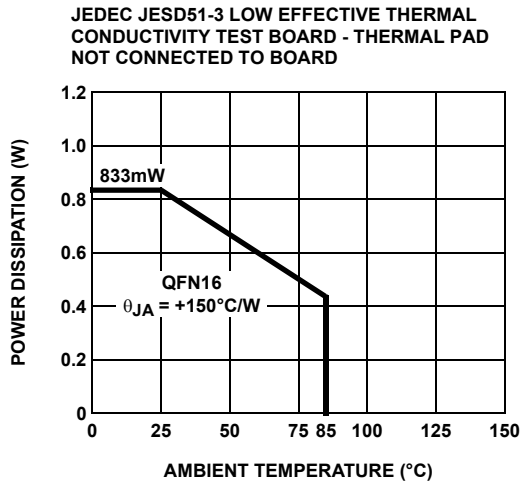

FIGURE 13. PACKAGE POWER DISSIPATION vs AMBIENT TEMPERATURE

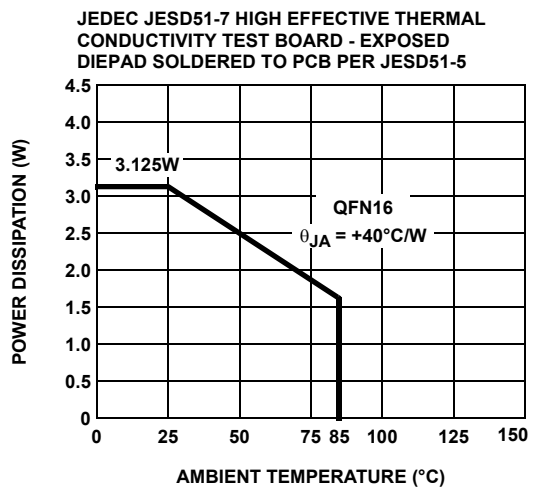

FIGURE 14. PACKAGE POWER DISSIPATION vs AMBIENT TEMPERATURE

Applications Information

Product Description

The ISL1536 consists of two sets of high-power line driver amplifiers that can be connected for full duplex differential line transmission. The amplifiers are designed to be used with ADSL2+ signals up to 2.2MHz. Each amplifier has identical positive gain connections resulting in optimum common-mode rejection. A typical interface circuit configuration is shown in Figure 15.

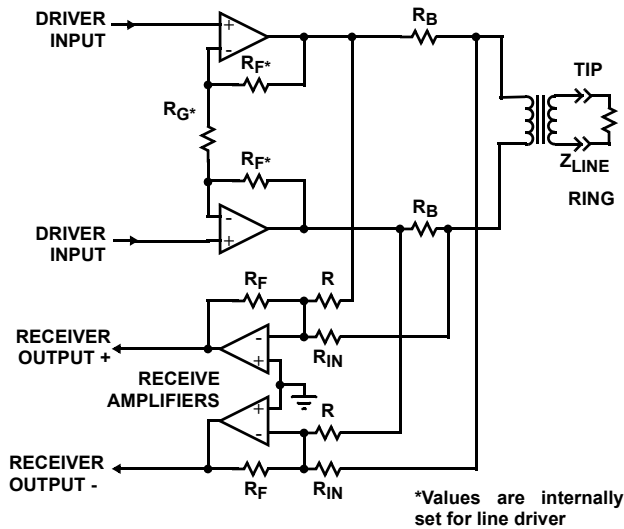

FIGURE 15. TYPICAL INTERFACE CIRCUIT CONFIGURATION

Integrated Components

ISL1536 integrates bias and feedback resistors, minimizing the number of external components. The gain is fixed at +12.85V/V.

The VBAB and VBCD pins also integrate a pair of 7.5kΩ and 50kΩ resistors on each port to bias the line driver for single and dual supply usage. When powering the line driver with a single supply, VBAB and VBCD pins are floated. When using dual supplies, VBAB and VBCD pins are grounded.

Integration of these components in the line driver minimizes assembly cost and board space.

Impedance Matching

R_B in Figure 15 depends on the line impedance and transformer's turns ratio. Line impedance is characterized to be 100Ω across tip and ring. If a 1:N transformer is used, R_B can be calculated according to Equation 1:

$$\left(R_B = \frac{100}{N^2} \times 0.5 \right) \quad (\text{EQ. 1})$$

Revision History

DATE	REVISION	CHANGE
November 20, 2012	FN6508.4	Added Note 3 to "Ordering Information" on page 1. Changed HBM from 3kV to 4kV in "Absolute Maximum Ratings" on page 3. Changed MM from 300V to 250V in "Absolute Maximum Ratings" on page 3 Added Note 5 to "Electrical Specifications" table on page 4.
March 8, 2010	FN6508.3	On page 4, changed the "Maximum Operating Supply Voltage" TYP from $\pm 12.6V$ to $\pm 13.2V$
February 8, 2010		On page 3 in the "Electrical Specifications" table, changed $V_{OUT-DIS}$ Max spec from $\pm 300mV$ to $\pm 800mV$
May 29, 2009		<p>Added Revision History beginning from rev 3.</p> <p>Changed the logic high level (VIH) on page 3 from Min 2.0V to Min 2.2V, which is consistent with the intended applications (AFE output logic high levels are typically at 3.3V with 2.4V minimum) while providing added margin to internal threshold variation.</p> <p>On page 1 in the first paragraph, changed: "This device features a high drive capability of 400mA while consuming only 3mA..." to "This device features a high drive capability of 400mA while consuming only 4mA..."</p> <p>Added Theta JA and applicable note to "Thermal Information" on page 3.</p> <p>Removed VS, Supply Voltage row in spec table. Added Maximum and Minimum Operating Supply Voltages ($V_{S(MAX)}$ and $V_{S(MIN)}$) with typical specs of $\pm 12.6V$ and $\pm 7.5V$ to "SUPPLY CHARACTERISTICS" on page 4.</p> <p>Added "DISAB = DISCD = 0" to "Electrical Specifications" table common conditions.</p>

© Copyright Intersil Americas LLC 2008-2013. All Rights Reserved.
All trademarks and registered trademarks are the property of their respective owners.

For additional products, see www.intersil.com/en/products.html

Intersil products are manufactured, assembled and tested utilizing ISO9001 quality systems as noted in the quality certifications found at www.intersil.com/en/support/qualandreliability.html

Intersil products are sold by description only. Intersil may modify the circuit design and/or specifications of products at any time without notice, provided that such modification does not, in Intersil's sole judgment, affect the form, fit or function of the product. Accordingly, the reader is cautioned to verify that datasheets are current before placing orders. Information furnished by Intersil is believed to be accurate and reliable. However, no responsibility is assumed by Intersil or its subsidiaries for its use; nor for any infringements of patents or other rights of third parties which may result from its use. No license is granted by implication or otherwise under any patent or patent rights of Intersil or its subsidiaries.

For information regarding Intersil Corporation and its products, see www.intersil.com

Package Outline Drawing

L16.4x4E

16 LEAD QUAD FLAT NO-LEAD PLASTIC PACKAGE

Rev 0, 4/08

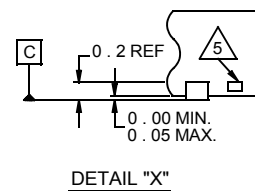
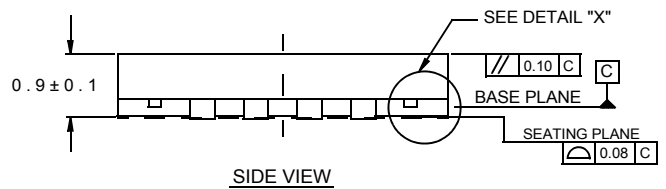
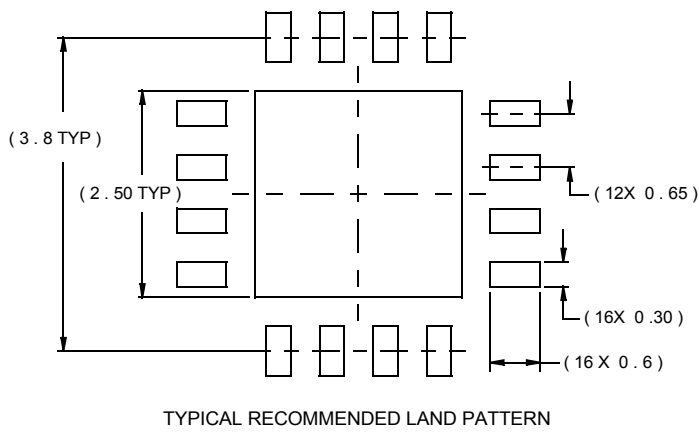
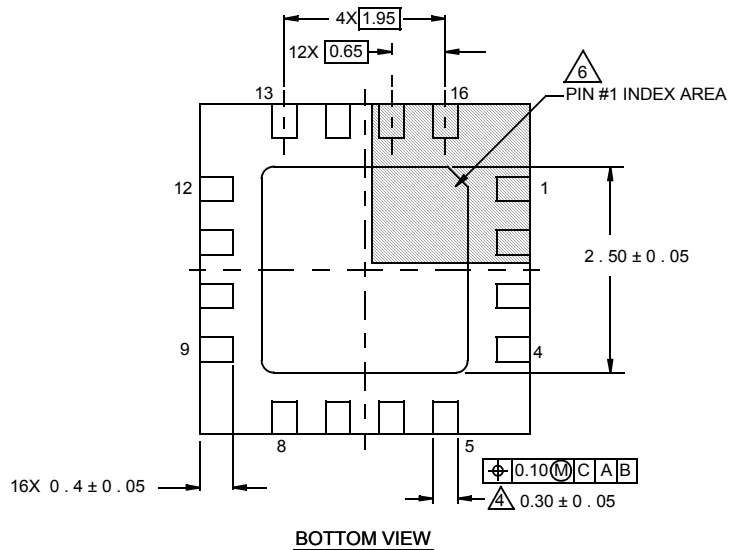
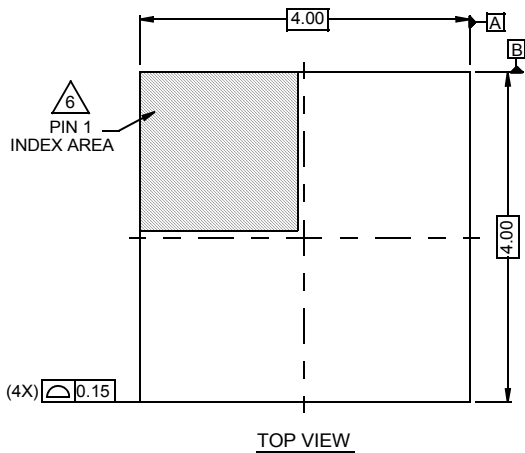

NOTES:

1. Dimensions are in millimeters.
Dimensions in () for Reference Only.
2. Dimensioning and tolerancing conform to AMSE Y14.5m-1994.
3. Unless otherwise specified, tolerance : Decimal ± 0.05
4. Dimension b applies to the metallized terminal and is measured between 0.15mm and 0.30mm from the terminal tip.
5. Tiebar shown (if present) is a non-functional feature.
6. The configuration of the pin #1 identifier is optional, but must be located within the zone indicated. The pin #1 identifier may be either a mold or mark feature.