

SLG55550 SLG5550A



USB Host Charger Identification Analog Switches

General Description

The SLG55550/SLG5550A is a USB device that combines high speed USB switches with a USB host charger (dedicated charger) identification circuit. The device supports both the latest USB Battery Charging Specification Revision 1.1 including data contact detection and a set resistor bias for Apple compliant devices as well as legacy USB D+/D- short detection using data line pull-up.

Features

- High Speed USB Switching
- Low 4.0 pF (typ) On Capacitance
- Low 4.0 Ω (typ) On Resistance
- Low 0.5 Ω (typ) On Resistance Flatness
- 2.8 V to 5.5 V Supply Range
- Low 8 μ A (typ) Supply Current
- Automatic USB Charger Identification Circuit
- USB Battery Charging Specification 1.2 compliant
- Pb-Free / RoHS Compliant
- Halogen-Free
- 3 x 3 mm TDFN-10 Package

Pin Configuration

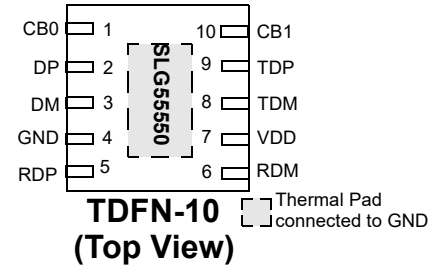

Block Diagram

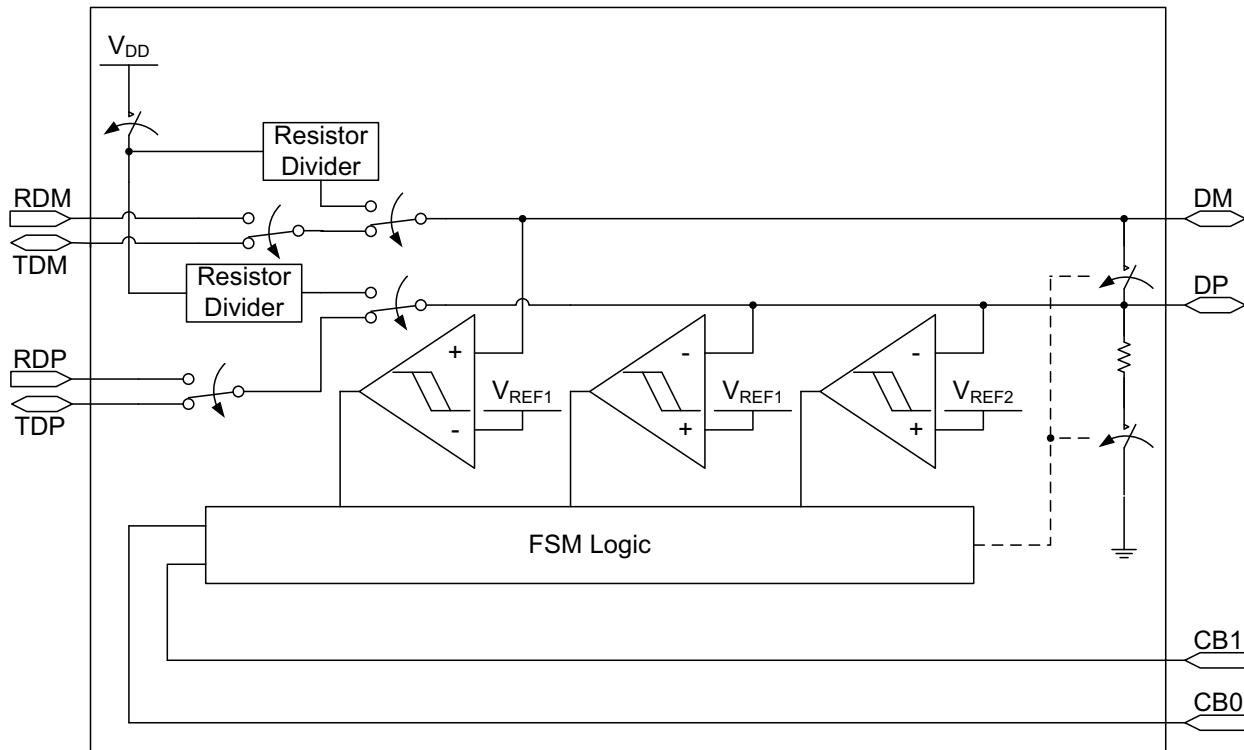

Pin Description

Pin #	Name	Type	Description
1	CB0	Input	Switch Control Bit See Digital Input States Table on page 6
2	DP	Input/Output	USB Connector D+
3	DM	Input/Output	USB Connector D-
4	GND	GND	Ground
5	RDP	Input	External Resistor Bias Input for D+ and Selection for External Resistors in RDP and RDM
6	RDM	Input	External Resistor Bias Input for D-
7	VDD	PWR	Power Supply. Connect a 0.1 μ F capacitor between VDD and GND as close as possible to the device
8	TDM	Input/Output	Host USB Transceiver D- Connection
9	TDP	Input/Output	Host USB Transceiver D+ Connection
10	CB1	Input	Switch Control Bit See Digital Input States Table on page 6
11	Thermal Pad	GND	Ground

Ordering Information

Part Number	Type
SLG55550V	TDFN-10
SLG55550AV	TDFN-10
SLG55550VTR	TDFN-10 - Tape and Reel
SLG55550AVTR	TDFN-10 - Tape and Reel

Absolute Maximum Conditions

Parameter	Min.	Max.	Unit
Supply Voltage	-0.3	6.0	V
Continuous Current into any terminal	-30	+30	mA
Continuous Power Dissipation	--	1951	mW
Operating Temperature Range	-40	85	°C
Junction Temperature		150	°C
Storage Temperature Range	-65	150	°C
Lead Temperature (Soldering, 10s)		260	°C

Electrical Characteristics - Power Supply

$V_{DD} = 2.8V$ to $5.5V$, $T_A = 25^\circ C$ (unless specified otherwise)

Symbol	Parameter	Condition/Note	Min.	Typ.	Max.	Unit
V_{DD}	Power Supply Range	$V_{CB} > V_{IH}$	2.8	--	5.5	V
I_{DD}	Supply Current $V_{DD} = 3.3$	$V_{CB0} = V_{CB1} = V_{DD}$	--	1	--	μA
		$V_{CB0} = 0V, V_{CB1} = V_{DD}$	--	7	--	μA
		External Resistors used. $V_{CB0} = V_{CB1} = 0V$ or $V_{CB0} = V_{DD} \& V_{CB1} = 0V$	--	7	--	μA
		Internal Resistors used. $V_{CB0} = V_{CB1} = 0V$ or $V_{CB0} = V_{DD} \& V_{CB1} = 0V$	--	75	--	μA
	Supply Current $V_{DD} = 5.5$	$V_{CB0} = V_{CB1} = V_{DD}$	--	2	--	μA
		$V_{CB0} = 0V, V_{CB1} = V_{DD}$	--	9	--	μA
		External Resistors used. $V_{CB0} = V_{CB1} = 0V$ or $V_{CB0} = V_{DD} \& V_{CB1} = 0V$	--	9	--	μA
		Internal Resistors used. $V_{CB0} = V_{CB1} = 0V$ or $V_{CB0} = V_{DD} \& V_{CB1} = 0V$	--	120	--	μA
ΔI_{DD}	Supply Current Increase	$0 \leq V_{CB} \leq V_{IL}$ or $V_{IH} \leq V_{CB} \leq V_{DD}$	--	--	2	μA

Electrical Characteristics - Analog Switch

$V_{DD} = 2.8V$ to $5.5V$, $T_A = 25^\circ C$ (unless specified otherwise)

Symbol	Parameter	Condition/Note	Min.	Typ.	Max.	Unit
V_{DP}, V_{DM}	Analog signal Range		0	--	V_{DD}	V
R_{ON}	On Resistance TDP/TDM Switch	$V_{DD} = -0.4V$ to $0.4V, I = 10mA$	--	4	--	Ω
		$V_{DP} = V_{DM} = 0V$ to V_{DD} $V_{DD} = 5V$	--	--	10	Ω
ΔR_{ON}	On Resistance Match between channels TDP/TDM Switch	$V_{DD} = 5.0V$ $V_{DP} = V_{DM} = 400mV$ $I_{DP} = I_{DM} = 10mA$	--	0.1	--	Ω
R_{FLAT}	On Resistance flatness TDP/TDM Switch	$V_{DD} = 5.0V$ $V_{DP} = V_{DM} = 0V$ to V_{DD} $I_{DP} = I_{DM} = 10mA$	--	0.5	--	Ω

Electrical Characteristics - Analog Switch

$V_{DD} = 2.8V$ to $5.5V$, $T_A = 25^\circ C$ (unless specified otherwise)

Symbol	Parameter	Condition/Note	Min.	Typ.	Max.	Unit
R_{SHORT}	On Resistance of TDP/TDM Short	$V_{CB} = 0V$ $V_{DP} = 1V$ $I_{DP} = I_{DM} = 10mA$	--	50	70	Ω
I_{TDPOFF} , I_{TDMOFF}	Off-Leakage Current	$V_{DD} = 3.6V$ $V_{DP} = V_{DM} = 0.3V$ to $3.3V$ $V_{TDP} = V_{TDM} = 3.3V$ to $0.3V$ $V_{CB} = 0V$	-250	--	250	nA
I_{DPON} , I_{DMON}	Off-Leakage Current	$V_{DD} = 3.6V$ $V_{DP} = V_{DM} = 3.3V$ to $0.3V$ $V_{CB} = V_{DD}$	-250	--	250	nA

Electrical Characteristics - Dynamic Performance

$V_{DD} = 2.8V$ to $5.5V$, $T_A = 25^\circ C$ (unless specified otherwise)

Symbol	Parameter	Condition/Note	Min.	Typ.	Max.	Unit
T_{ON}	Turn On Time	V_{TDP} or $V_{TDM} = 1.5V$ $R_L = 300\Omega$ $C_L = 35pF$	--'	20	100	μs
T_{OFF}	Turn Off Time	V_{TDP} or $V_{TDM} = 1.5V$ $R_L = 300\Omega$ $C_L = 35pF$	--'	1	5	μs
T_{PLH} , T_{PHL}	TDP/TDM Switch Propagation Delay	$R_L = R_S = 50\Omega$	--	60	--	ps
T_{SKEW}	Output Skew	Skew between DP and DM when connected to TDP and TDM $R_L = R_S = 50\Omega$	--	40	--	ps
C_{OFF}	TDP/TDM Off-Capacitance	$f = 1MHz$	--'	2.0	--	pF
C_{ON}	DP/DM On-Capacitance	$f = 240MHz$	--'	4.0	5.5	pF
BW	-3dB Bandwidth	$R_L = R_S = 50\Omega$	--	1000	--	MHz
V_{ISO}	Off-Isolation	V_{TDP} , $V_{DP} = 0dBm$ $R_L = R_S = 50\Omega$ $f = 250MHz$	--	-20	--	dB
V_{CT}	Crosstalk	V_{TDP} , $V_{DP} = 0dBm$ $R_L = R_S = 50\Omega$ $f = 250MHz$	--	-25	--	dB

Electrical Characteristics - Internal Resistors

$V_{DD} = 2.8V$ to $5.5V$, $T_A = 25^\circ C$ (unless specified otherwise)

Symbol	Parameter	Condition/Note	Min.	Typ.	Max.	Unit
R_{PD}	DP/DM Short Pull-down		350	500	700	$k\Omega$
RT_{RP}	RP1/RP2 Ratio		1.485	1.5	1.515	Ratio
R_{RP}	RP1 + RP2 Resistance		93.75	125.0	156.25	$k\Omega$
RT_{RM}	RM1/RM2 Ratio		0.8544	0.863	0.872	Ratio
R_{RM}	RM1 + RM2 Resistance		69.75	93.0	115.18	$k\Omega$

Electrical Characteristics - Logic Input

$V_{DD} = 2.8V$ to $5.5V$, $T_A = 25^\circ C$ (unless specified otherwise)

Symbol	Parameter	Condition/Note	Min.	Typ.	Max.	Unit
V_{IH}	CB Input Logic High		1.4	--	--	V
V_{IL}	CB Input Logic Low		--	--	0.4	V
I_{IN}	CB Input Leakage Current	$V_{DD} = 5.5V$ $0 \leq V_{CB} \leq V_{IL}$ or $V_{IH} \leq V_{CB} \leq V_{DD}$	-1	--	1	μA

Electrical Characteristics - ESD Protection

$V_{DD} = 2.8V$ to $5.5V$, $T_A = 25^\circ C$ (unless specified otherwise)

Symbol	Parameter	Condition/Note	Min.	Typ.	Max.	Unit
V_{ESD}	ESD Protection Level (DP and DM Only)	Human Body Model	--	± 8	--	kV
V_{ESD}	ESD Protection Level (All other pins)	Human Body Model	--	± 2	--	kV

Digital Input States - SLG55550

V _{DD}	RDP <0.4V = Internal Resistor >0.4V = External Resistor	CB0	CB1	DP/DM Position	Internal or External Resis- tor Connected to DP/DM	Comment
3.3V	RDP < 0.4V	X	X	--	--	Not Recommended
	RDP > 0.4V	0	0	Autodetection Circuit Active	External Resistor	Auto Mode
		0	1	Shorted	Not Connected	Auto Mode Disabled
		1	0	Connected to Resistor- Divider	External Resistor	Auto Mode Disabled
		1	1	Connected to TDP/TDM	Not Connected	USB Traffic Active
5.0V	RDP < 0.4V	0	0	Autodetection Circuit Active	Internal Resistor	Auto Mode
		0	1	Shorted	Not Connected	Auto Mode Disabled
		1	0	Connected to Resistor- Divider	Internal Resistor	Auto Mode Disabled
		1	1	Connected to TDP/TDM	Not Connected	USB Traffic Active
	RDP > 0.4V	0	0	Autodetection Circuit Active	External Resistor	Auto Mode
		0	1	Shorted	Not Connected	Auto Mode Disabled
		1	0	Connected to Resistor- Divider	External Resistor	Auto Mode Disabled
		1	1	Connected to TDP/TDM	Not Connected	USB Traffic Active

Digital Input States - SLG55550A

V _{DD}	RDP	CB0	CB1	DP/DM Position	Internal or External Resis- tor Connected to DP/DM	Comment
5.0V	X	0	0	Autodetection Circuit Active	Internal Resistor	Auto Mode
	X	0	1	Shorted	Not Connected	Auto Mode Disabled
	X	1	0	Connected to Resistor- Divider	External Resistor	Auto Mode Disabled
	X	1	1	Connected to TDP/TDM	Not Connected	USB Traffic Active

Package Top Marking System Definition

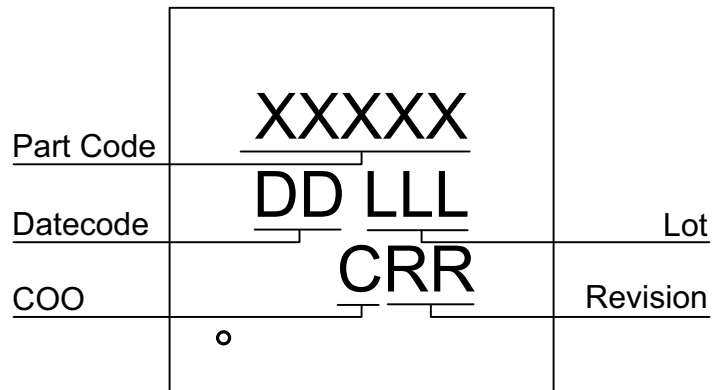

- XXXXX – Part ID Field: identifies the specific device configuration
- DD – Date Code Field: Coded date of manufacture
- LLL – Lot Code: Designates Lot #
- C – Assembly Site/COO: Specifies Assembly Site/Country of Origin
- RR – Revision Code: Device Revision

Package Drawing and Dimensions

10 Lead TDFN Package

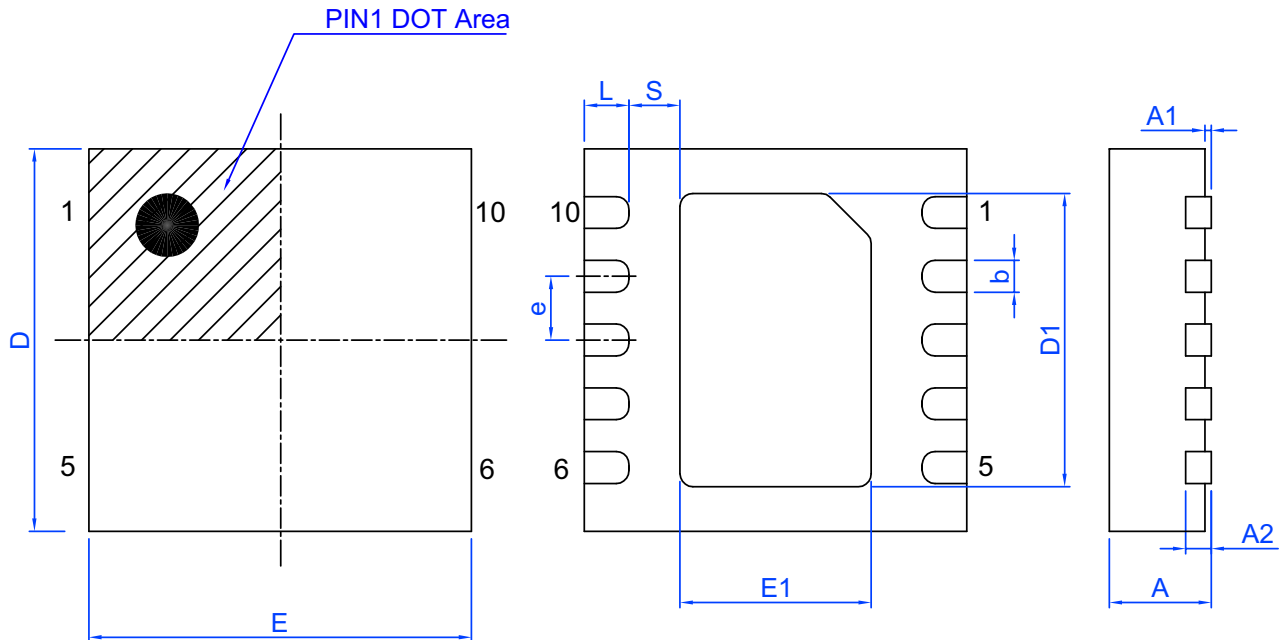

Unit: mm

Symbol	Min	Nom.	Max	Symbol	Min	Nom.	Max
A	0.70	0.75	0.80	D	2.95	3.00	3.05
A1	0.005	-	0.060	E	2.95	3.00	3.05
A2	0.15	0.20	0.25	D1	2.20	2.30	2.40
b	0.20	0.25	0.30	E1	1.40	1.50	1.60
C	0.35 REF			e	0.50 BSC		
S	0.25	-	-	L	0.30	0.35	0.40

Tape and Reel Specifications

Package Type	# of Pins	Nominal Package Size [mm]	Max Units		Reel & Hub Size [mm]	Leader (min)		Trailer (min)		Tape Width [mm]	Part Pitch [mm]
			per Reel	per Box		Pockets	Length [mm]	Pockets	Length [mm]		
TDFN 10L Green	10	3 x 3 x 0.75	3,000	3,000	178 / 60	100	400	100	400	8	4

Carrier Tape Drawing and Dimensions

Package Type	Pocket BTM Length	Pocket BTM Width	Pocket Depth	Index Hole Pitch	Pocket Pitch	Index Hole Diameter	Index Hole to Tape Edge	Index Hole to Pocket Center	Tape Width
	A0	B0	K0	P0	P1	D0	E	F	W
TDFN 10L Green	3.25	3.25	1.1	4	4	1.55	1.75	3.5	8

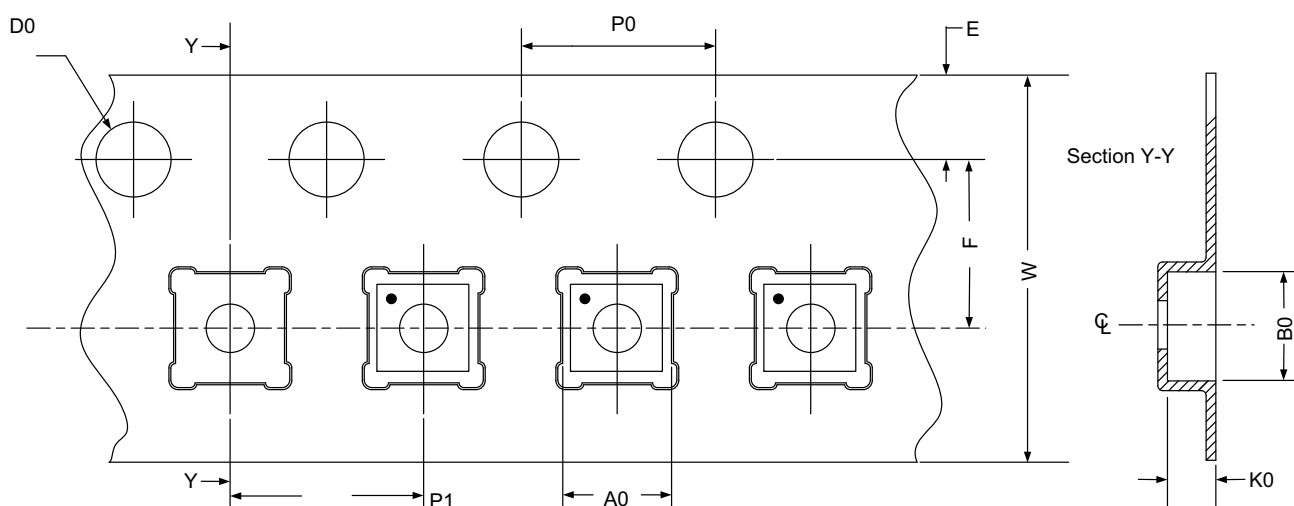

Refer to EIA-481 specification

Recommended Reflow Soldering Profile

Please see IPC/JEDEC J-STD-020: latest revision for reflow profile based on package volume of 6.75 mm³ (nominal). More information can be found at www.jedec.org.

IMPORTANT NOTICE AND DISCLAIMER

RENESAS ELECTRONICS CORPORATION AND ITS SUBSIDIARIES (“RENESAS”) PROVIDES TECHNICAL SPECIFICATIONS AND RELIABILITY DATA (INCLUDING DATASHEETS), DESIGN RESOURCES (INCLUDING REFERENCE DESIGNS), APPLICATION OR OTHER DESIGN ADVICE, WEB TOOLS, SAFETY INFORMATION, AND OTHER RESOURCES “AS IS” AND WITH ALL FAULTS, AND DISCLAIMS ALL WARRANTIES, EXPRESS OR IMPLIED, INCLUDING, WITHOUT LIMITATION, ANY IMPLIED WARRANTIES OF MERCHANTABILITY, FITNESS FOR A PARTICULAR PURPOSE, OR NON-INFRINGEMENT OF THIRD-PARTY INTELLECTUAL PROPERTY RIGHTS.

These resources are intended for developers who are designing with Renesas products. You are solely responsible for (1) selecting the appropriate products for your application, (2) designing, validating, and testing your application, and (3) ensuring your application meets applicable standards, and any other safety, security, or other requirements. These resources are subject to change without notice. Renesas grants you permission to use these resources only to develop an application that uses Renesas products. Other reproduction or use of these resources is strictly prohibited. No license is granted to any other Renesas intellectual property or to any third-party intellectual property. Renesas disclaims responsibility for, and you will fully indemnify Renesas and its representatives against, any claims, damages, costs, losses, or liabilities arising from your use of these resources. Renesas' products are provided only subject to Renesas' Terms and Conditions of Sale or other applicable terms agreed to in writing. No use of any Renesas resources expands or otherwise alters any applicable warranties or warranty disclaimers for these products.

(Disclaimer Rev.1.01 Jan 2024)

Corporate Headquarters

TOYOSU FORESIA, 3-2-24 Toyosu,
Koto-ku, Tokyo 135-0061, Japan
www.renesas.com

Trademarks

Renesas and the Renesas logo are trademarks of Renesas Electronics Corporation. All trademarks and registered trademarks are the property of their respective owners.

Contact Information

For further information on a product, technology, the most up-to-date version of a document, or your nearest sales office, please visit www.renesas.com/contact-us/.