

### General Description

The SLG7NT408V is a 7.8 mΩ 4 A single-channel load switch that is able to switch 0.85 V to 5 V power rails. The product is packaged in an ultra-small 1.5 x 2.0 mm package.

### Features

- 1.5 x 2.0 mm FC-TDFN 8L package (2 fused pins for drain and 2 fused pins for source)
- Logic level ON pin capable of supporting 0.85 V CMOS Logic
- User selectable ramp rate with external capacitor
- 7.8 mΩ RDS<sub>ON</sub> while supporting 4 A
- Two Over Current Protection Modes
  - Short Circuit Current Limit
  - Active Current Limit
- Over Temperature Protection
- Pb-Free / Halogen-Free / RoHS compliant
- Operating Temperature: -20 °C to 70°C
- Operating Voltage: 2.5 V to 5.5 V

### Pin Configuration

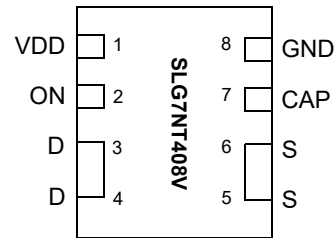

**8-pin FC-TDFN  
(Top View)**

### Applications

- Notebook Power Rail Switching
- Tablet Power Rail Switching
- Smartphone Power Rail Switching

### Block Diagram

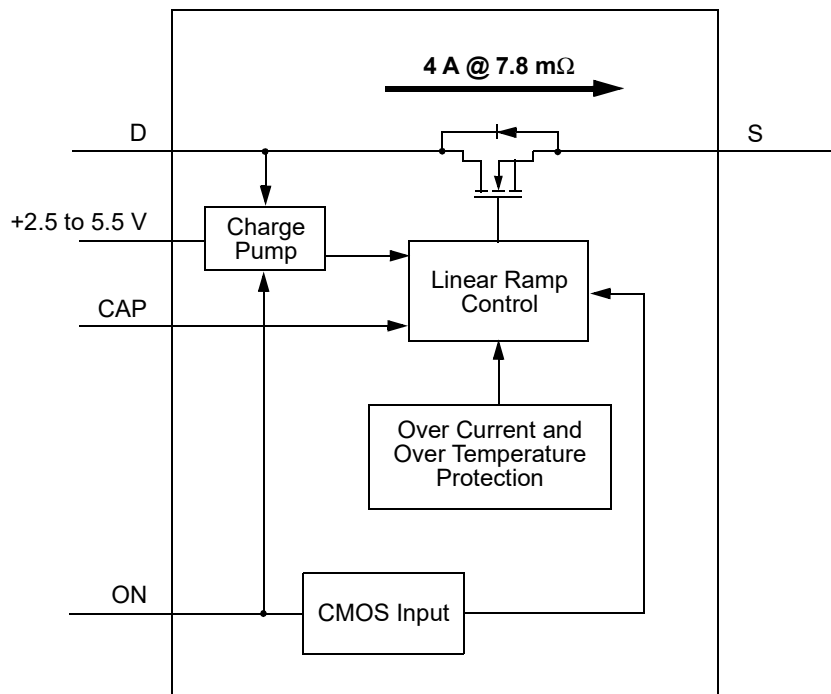

## Pin Description

Pin #	Pin Name	Type	Pin Description
1	VDD	PWR	VDD power for load switch control (2.5 V to 5.5 V)
2	ON	Input	Turns MOSFET ON (4 M $\Omega$ pull down resistor) CMOS input with VIL < 0.3 V, VIH > 0.85 V
3	D	MOSFET	Drain of Power MOSFET (fused with pin 4)
4	D	MOSFET	Drain of Power MOSFET (fused with pin 3)
5	S	MOSFET	Source of Power MOSFET (fused with pin 6)
6	S	MOSFET	Source of Power MOSFET (fused with pin 5)
7	CAP	Input	Capacitor for controlling power rail ramp rate
8	GND	GND	Ground

## Ordering Information

Part Number	Type	Production Flow
SLG7NT408V	FC-TDFN 8L	Commercial, -20 °C to 70 °C
SLG7NT408VTR	FC-TDFN 8L (Tape and Reel)	Commercial, -20 °C to 70 °C

## Absolute Maximum Ratings

Parameter	Description	Conditions	Min.	Typ.	Max.	Unit
$V_{DD}$	Power Supply		--	--	7	V
$T_S$	Storage Temperature		-65	--	150	°C
$ESD_{HBM}$	ESD Protection	Human Body Model	2000	--	--	V
$W_{DIS}$	Package Power Dissipation		--	--	1	W
MOSFET $IDS_{PK}$	Peak Current from Drain to Source	For no more than 1 ms with 1% duty cycle	--	--	6	A

Note: Stresses greater than those listed under "Absolute Maximum Ratings" may cause permanent damage to the device. This is a stress rating only and functional operation of the device at these or any other conditions above those indicated in the operational sections of this specification is not implied. Exposure to absolute maximum rating conditions for extended periods may affect reliability.

## Electrical Characteristics

$T_A = -20$  to  $70$  °C (unless otherwise stated)

Parameter	Description	Conditions	Min.	Typ.	Max.	Unit
$V_{DD}$	Power Supply Voltage	-20 to 70°C	2.5	--	5.5	V
$I_{DD}$	Power Supply Current (PIN 1)	when OFF	--	--	1	μA
		when ON, No load	--	70	100	μA
$RDS_{ON}$	Static Drain to Source ON Resistance	$T_A$ 25°C @ 100 mA	--	7.8	8.5	mΩ
		$T_A$ 70°C @ 100 mA	--	8.5	9.6	mΩ
$IDS$	Operating Current	$V_D = 1.0$ V to 5.5 V	--	--	4	A
$V_D$	Drain Voltage		0.85	--	$V_{DD}$	V
$T_{ON\_Delay}$	ON pin Delay Time	50% ON to Ramp Begin, $R_L = 20$ Ω, $C_L = 10$ μF	0	300	500	μs
$T_{Total\_ON}$	Total Turn On Time	50% ON to 90% $V_S$	Configurable <sup>1</sup>			ms
		Example: CAP (PIN 7) = 4 nF, $V_{DD} = V_D = 5$ V, Source_Cap = 10 μF, $R_L = 20$ Ω	--	1.96	--	ms
$T_{SLEWRATE}$	Slew Rate	10% $V_S$ to 90% $V_S$	Configurable <sup>1</sup>			V/ms
		Example: CAP (PIN 7) = 4 nF, $V_{DD} = V_D = 5$ V, Source_Cap = 10 μF, $R_L = 20$ Ω	--	3.0	--	V/ms
$CAP_{SOURCE}$	Source Cap	Source to GND	--	--	500	μF
$ON\_V_{IH}$	High Input Voltage on ON pin		0.85	--	$V_{DD}$	V
$ON\_V_{IL}$	Low Input Voltage on ON pin		-0.3	0	0.3	V
$I_{LIMIT}$	Active Current Limit	MOSFET will automatically limit current when $V_S > 250$ mV	--	6.0	--	A
	Short Circuit Current Limit	MOSFET will automatically limit current when $V_S < 250$ mV	--	--	0.5	A
$THERM_{ON}$	Thermal shutoff turn-on temperature		--	125	--	°C
$THERM_{OFF}$	Thermal shutoff turn-off temperature		--	100	--	°C
$THERM_{TIME}$	Thermal shutoff time		--	--	1	ms
$T_{OFF\_Delay}$	OFF Delay Time	50% ON to $V_S$ Fall, $V_{DD} = V_D = 5$ V, $R_L = 20$ Ω, no $C_L$	--	--	15	μs
$T_{FALL}$	$V_S$ Fall Time	90% $V_S$ to 10% $V_S$ , $V_{DD} = V_D = 5$ V, $R_L = 20$ Ω, no $C_L$	--	TBD	--	μs

Notes:

1. Refer to table for configuration details.

## SLG7NT408V Turn ON

The normal power on sequence is first  $V_{DD}$ , with  $V_D$  only being applied after  $V_{DD}$  is  $> 1$  V, and then ON after  $V_D$  is at least 90% of final value. The normal power off sequence is the power on sequence in reverse.

If  $V_{DD}$  and  $V_D$  are turned on at the same time then it is possible that a voltage glitch will appear on  $V_S$  before  $V_{DD}$  achieves 1 V which is the  $V_T$  of the main MOSFET. The size of the glitch is dependent on source and drain capacitance loading and the ramp rate of  $V_{DD}$  &  $V_D$ .

## SLG7NT408V Turn ON

The  $V_S$  ramp follows a linear path, not an RC limitation provided the ramp is slow enough to not be current limited by load capacitance.

## SLG7NT408V Current Limiting

The SLG7NT408V has two forms of current limiting.

### Standard Current Limiting Mode

Current is measured by mirroring the current through the main MOSFET. The mirrored current is then sent through a resistor creating a voltage  $V(i)$  proportional to the MOSFET current. The  $V(i)$  is then compared with a Band Gap voltage  $V(BG)$ . If  $V(i)$  exceeds the Band Gap voltage then the voltage  $V(g)$  on the gate of the main MOSFET is reduced. The  $V(g)$  continues to drop until  $V(i) < V(BG)$ . This response is a closed loop response and is therefore very fast and current limits in less than a few micro-seconds. There is no difference between peak or constant current limit.

### Temperature Cutoff

However, as the  $V(g)$  drops the  $R_{ds}(ON)$  of the main MOSFET will increase, thus limiting the current, but also increasing the power dissipation of the IC. The IC is very small and cannot dissipate much power. Therefore, if a current limit condition is sustained the IC will heat up. If the temperature exceeds approximately 120 °C, then  $V(g)$  will be brought low completely shutting off the main MOSFET. As the die cools the MOSFET will be turned back on at 100 °C.

If the current limiting condition has not been mitigated then the die will again heat up to 120 °C and the process will repeat.

### Short Circuit Current Limiting Mode

When  $V(S) < 250$  mV, which is the case if there is a solder bridge during the manufacturing process or a hard short on the power rail, then the current is limited to approximately 500 mA. This current limit is accomplished in the same manner as the Standard Current Limiting Mode with the exception that the current mirror is 15x greater. Because the current mirror is so much larger, a 15x smaller main MOSFET current is required to generate the same  $V(i)$ . If  $V(S)$  rises above approximately 250 mV, then this mode is automatically switched out.

**T<sub>Total\_ON</sub> vs. CAP @ V<sub>DD</sub> = 3.3 V**

SLG7NT408V T<sub>Total\_ON</sub>: ON (50%) - V<sub>S</sub> (90%)  
 V<sub>DD</sub> = 3.3 V, T<sub>A</sub> = 25 °C, C<sub>L</sub> = 10 μF, I<sub>DS</sub> = 100 mA

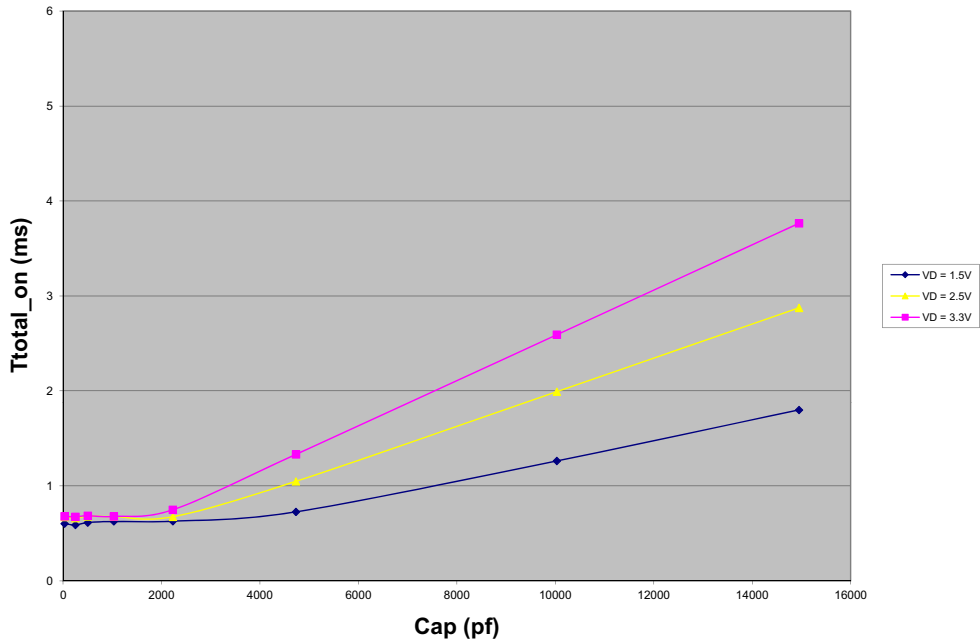

**T<sub>Total\_ON</sub> vs. CAP @ V<sub>DD</sub> = 5.0 V**

SLG7NT408V T<sub>Total\_ON</sub>: ON (50%) - V<sub>S</sub> (90%)  
 V<sub>DD</sub> = 5.0 V, T<sub>A</sub> = 25 °C, C<sub>L</sub> = 10 μF, I<sub>DS</sub> = 100 mA

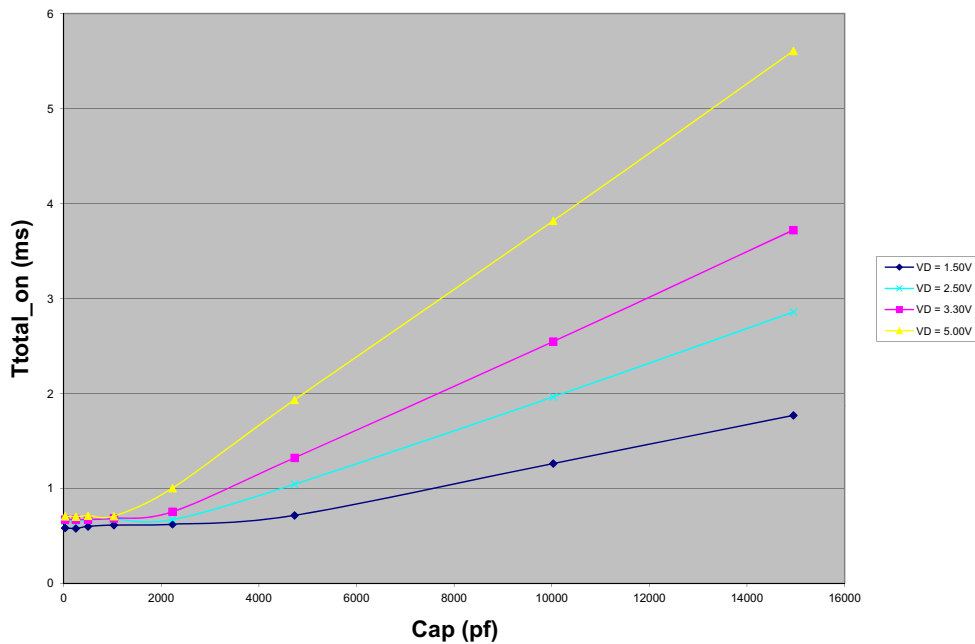

**T<sub>SLEW</sub> vs. CAP @ V<sub>DD</sub> = 3.3 V**

SLG7NT408V T<sub>SLEW</sub>: V<sub>S</sub> (10%) - V<sub>S</sub> (90%)  
 V<sub>DD</sub> = 3.3 V, T<sub>A</sub> = 25 °C, C<sub>L</sub> = 10 μF, I<sub>DS</sub> = 100 mA

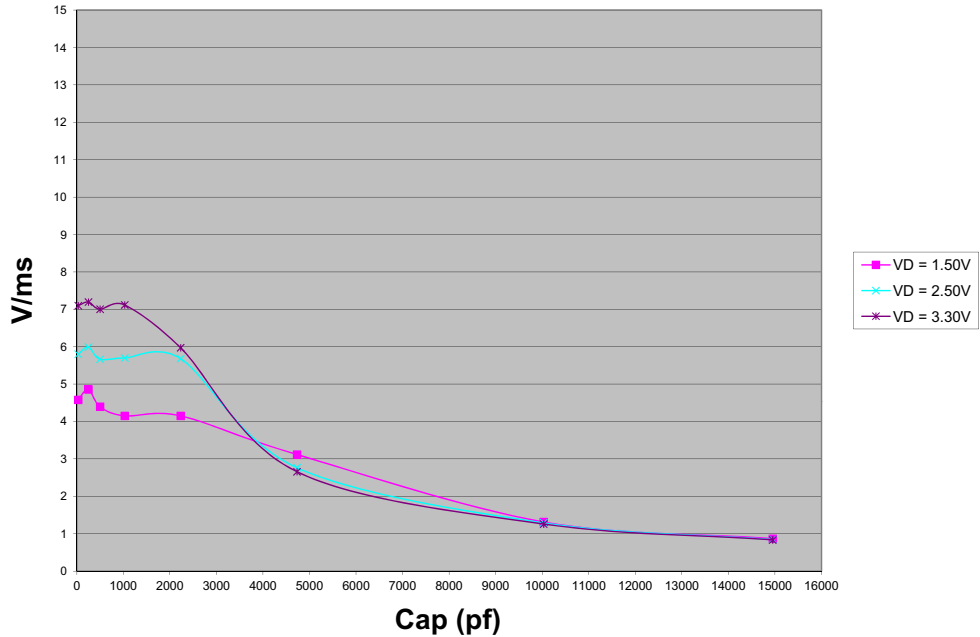

**T<sub>SLEW</sub> vs. CAP @ V<sub>DD</sub> = 5.0 V**

SLG7NT408V T<sub>SLEW</sub>: V<sub>S</sub> (10%) - V<sub>S</sub> (90%)  
 V<sub>DD</sub> = 5.0 V, T<sub>A</sub> = 25 °C, C<sub>L</sub> = 10 μF, I<sub>DS</sub> = 100 mA

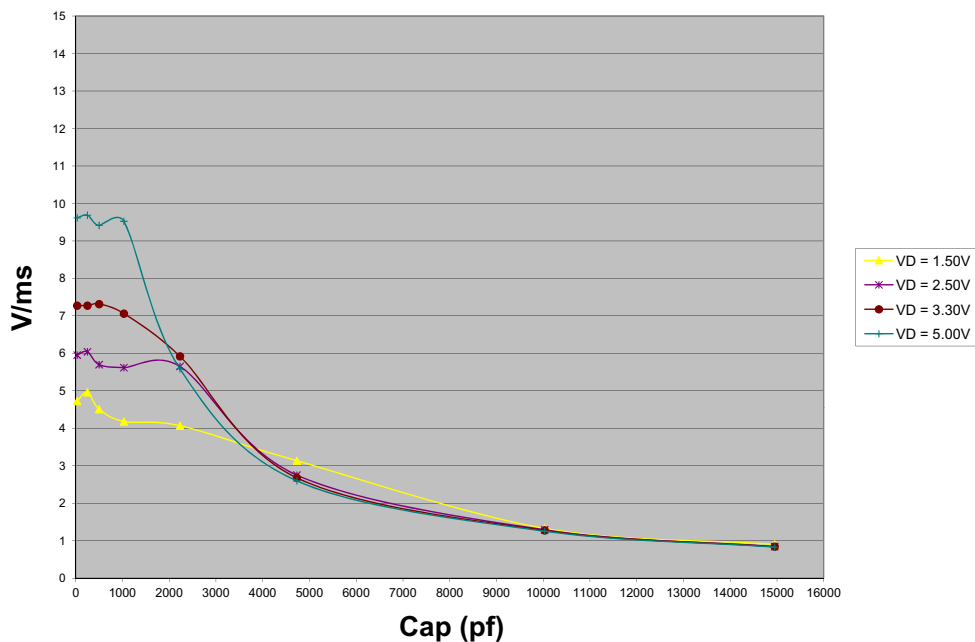

$T_{Total\_ON}$ ,  $T_{ON\_Delay}$  and Slew Rate Measurement

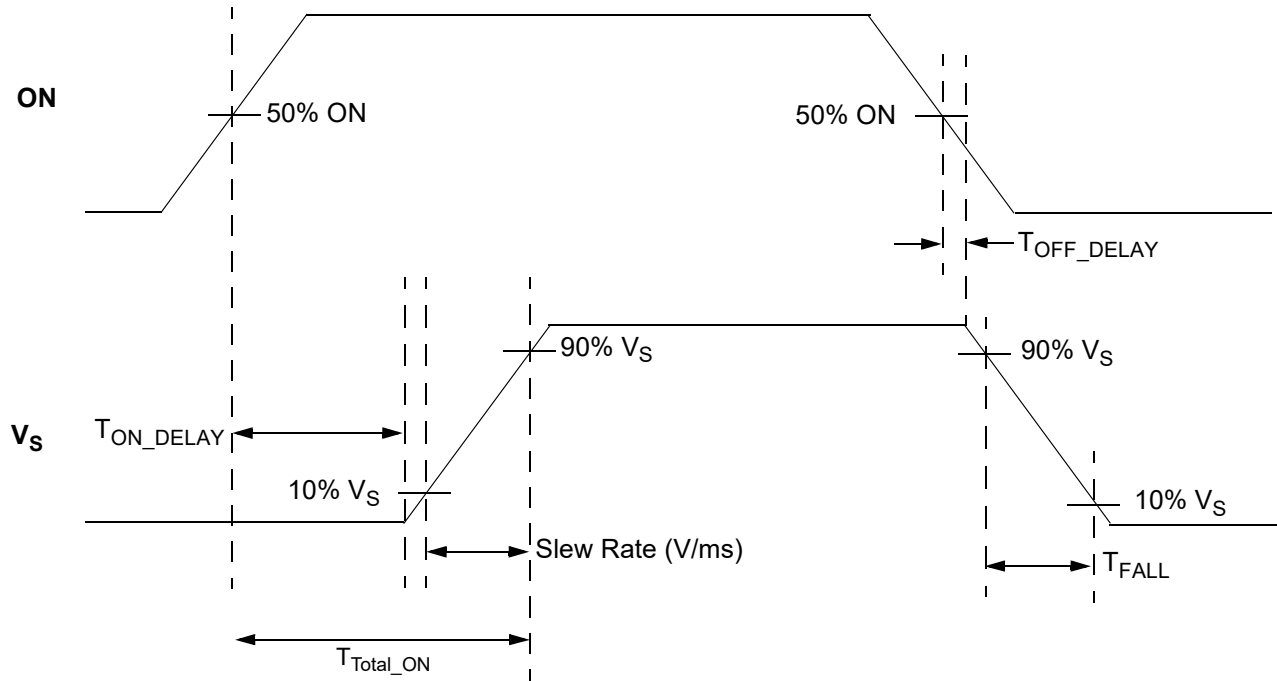

Package Top Marking System Definition

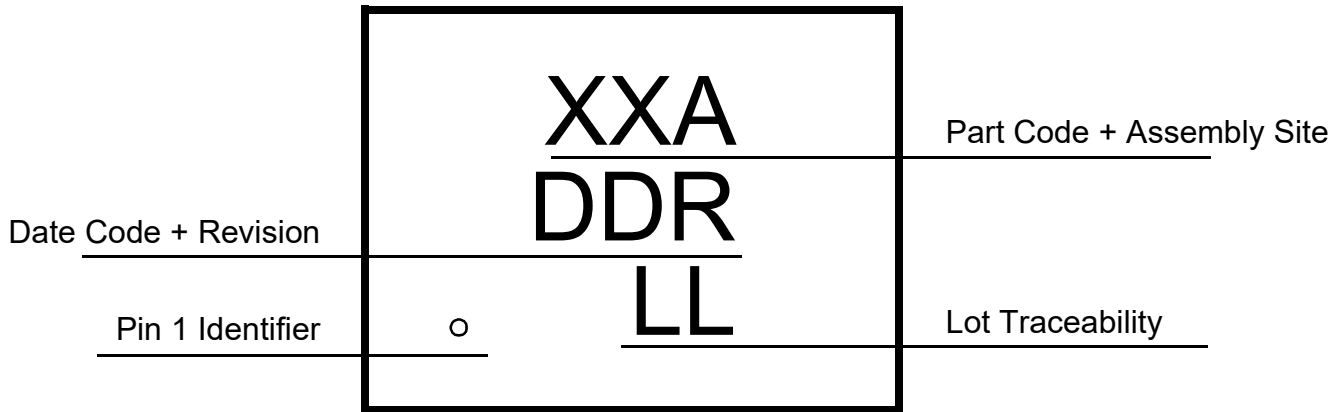



Package Drawing and Dimensions

8 Lead TDFN Package 1.5 x 2.0 mm (Fused Lead)  
JEDEC MO-252, Variation W2015D

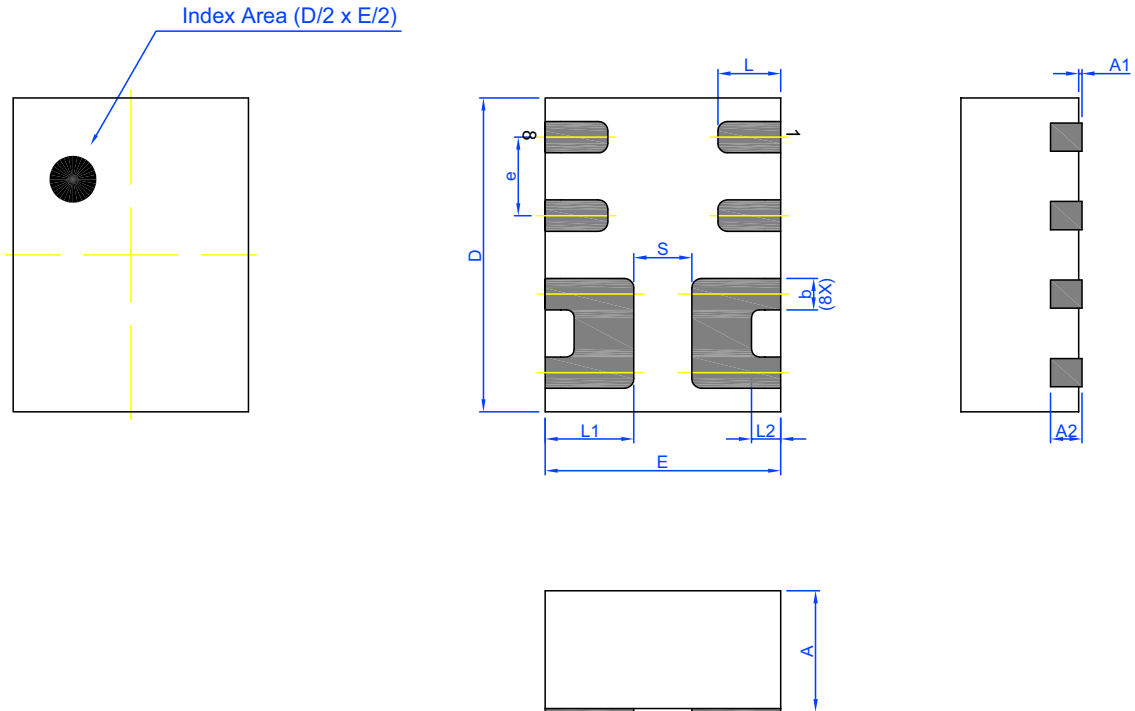

Unit: mm

Symbol	Min	Nom.	Max	Symbol	Min	Nom.	Max
A	0.70	0.75	0.80	L	0.35	0.40	0.45
A1	0.005	-	0.060	L1	0.515	0.565	0.615
A2	0.15	0.20	0.25	L2	0.135	0.185	0.235
b	0.15	0.20	0.25	e	0.50 BSC		
D	1.95	2.00	2.05	S	0.37 REF		
E	1.45	1.50	1.55				

**Tape and Reel Specifications**

Package Type	# of Pins	Nominal Package Size [mm]	Max Units		Reel & Hub Size [mm]	Leader (min)		Trailer (min)		Tape Width [mm]	Part Pitch [mm]
			per Reel	per Box		Pockets	Length [mm]	Pockets	Length [mm]		
TDFN 8L FC Green	8	1.5 x 2.0 x 0.75	3000	3000	178 / 60	100	400	100	400	8	4

**Carrier Tape Drawing and Dimensions**

Package Type	Pocket BTM Length	Pocket BTM Width	Pocket Depth	Index Hole Pitch	Pocket Pitch	Index Hole Diameter	Index Hole to Tape Edge	Index Hole to Pocket Center	Tape Width
	A0	B0	K0	P0	P1	D0	E	F	W
TDFN 8L FC Green	1.68	2.18	0.9	4	4	1.5	1.75	3.5	8

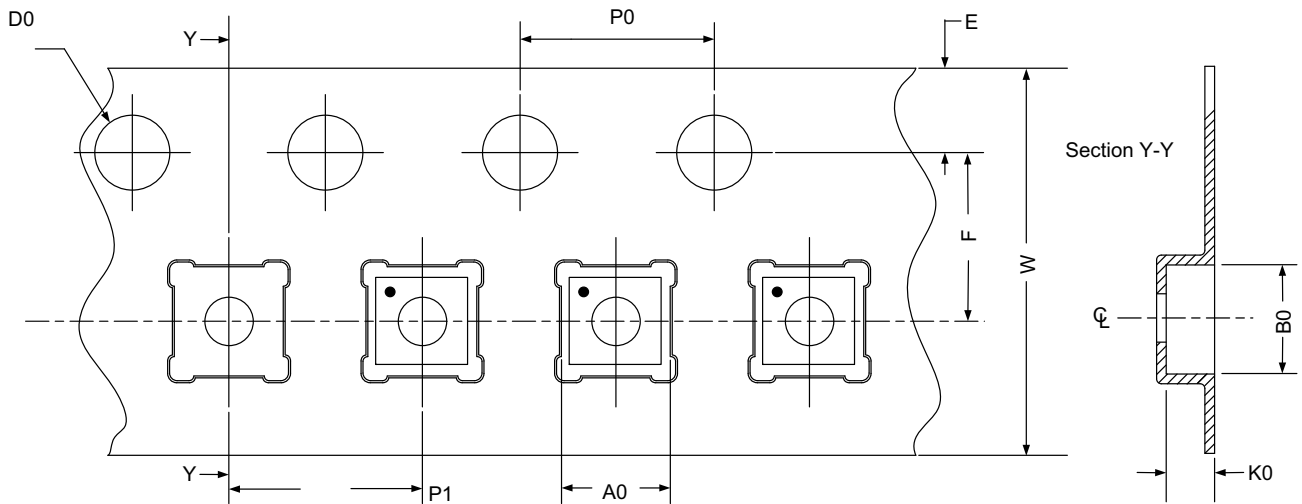

Refer to EIA-481 specification

**Recommended Reflow Soldering Profile**

Please see IPC/JEDEC J-STD-020: latest revision for reflow profile based on package volume of 2.25 mm<sup>3</sup> (nominal). More information can be found at [www.jedec.org](http://www.jedec.org).

---

## Revision History

Date	Version	Change
2/25/2022	1.02	Updated Company name and logo Fixed typos
9/9/2015	1.01	Updated Vd min = 0.85 V Updated Conditions in Electrical Characteristics Table

## IMPORTANT NOTICE AND DISCLAIMER

RENESAS ELECTRONICS CORPORATION AND ITS SUBSIDIARIES (“RENESAS”) PROVIDES TECHNICAL SPECIFICATIONS AND RELIABILITY DATA (INCLUDING DATASHEETS), DESIGN RESOURCES (INCLUDING REFERENCE DESIGNS), APPLICATION OR OTHER DESIGN ADVICE, WEB TOOLS, SAFETY INFORMATION, AND OTHER RESOURCES “AS IS” AND WITH ALL FAULTS, AND DISCLAIMS ALL WARRANTIES, EXPRESS OR IMPLIED, INCLUDING, WITHOUT LIMITATION, ANY IMPLIED WARRANTIES OF MERCHANTABILITY, FITNESS FOR A PARTICULAR PURPOSE, OR NON-INFRINGEMENT OF THIRD-PARTY INTELLECTUAL PROPERTY RIGHTS.

These resources are intended for developers who are designing with Renesas products. You are solely responsible for (1) selecting the appropriate products for your application, (2) designing, validating, and testing your application, and (3) ensuring your application meets applicable standards, and any other safety, security, or other requirements. These resources are subject to change without notice. Renesas grants you permission to use these resources only to develop an application that uses Renesas products. Other reproduction or use of these resources is strictly prohibited. No license is granted to any other Renesas intellectual property or to any third-party intellectual property. Renesas disclaims responsibility for, and you will fully indemnify Renesas and its representatives against, any claims, damages, costs, losses, or liabilities arising from your use of these resources. Renesas' products are provided only subject to Renesas' Terms and Conditions of Sale or other applicable terms agreed to in writing. No use of any Renesas resources expands or otherwise alters any applicable warranties or warranty disclaimers for these products.

(Disclaimer Rev.1.01 Jan 2024)

### Corporate Headquarters

TOYOSU FORESIA, 3-2-24 Toyosu,  
Koto-ku, Tokyo 135-0061, Japan  
[www.renesas.com](http://www.renesas.com)

### Trademarks

Renesas and the Renesas logo are trademarks of Renesas Electronics Corporation. All trademarks and registered trademarks are the property of their respective owners.

### Contact Information

For further information on a product, technology, the most up-to-date version of a document, or your nearest sales office, please visit [www.renesas.com/contact-us/](http://www.renesas.com/contact-us/).