

To our customers,

---

## Old Company Name in Catalogs and Other Documents

---

On April 1<sup>st</sup>, 2010, NEC Electronics Corporation merged with Renesas Technology Corporation, and Renesas Electronics Corporation took over all the business of both companies. Therefore, although the old company name remains in this document, it is a valid Renesas Electronics document. We appreciate your understanding.

Renesas Electronics website: <http://www.renesas.com>

April 1<sup>st</sup>, 2010  
Renesas Electronics Corporation

Issued by: Renesas Electronics Corporation (<http://www.renesas.com>)

Send any inquiries to <http://www.renesas.com/inquiry>.

## Notice

1. All information included in this document is current as of the date this document is issued. Such information, however, is subject to change without any prior notice. Before purchasing or using any Renesas Electronics products listed herein, please confirm the latest product information with a Renesas Electronics sales office. Also, please pay regular and careful attention to additional and different information to be disclosed by Renesas Electronics such as that disclosed through our website.
2. Renesas Electronics does not assume any liability for infringement of patents, copyrights, or other intellectual property rights of third parties by or arising from the use of Renesas Electronics products or technical information described in this document. No license, express, implied or otherwise, is granted hereby under any patents, copyrights or other intellectual property rights of Renesas Electronics or others.
3. You should not alter, modify, copy, or otherwise misappropriate any Renesas Electronics product, whether in whole or in part.
4. Descriptions of circuits, software and other related information in this document are provided only to illustrate the operation of semiconductor products and application examples. You are fully responsible for the incorporation of these circuits, software, and information in the design of your equipment. Renesas Electronics assumes no responsibility for any losses incurred by you or third parties arising from the use of these circuits, software, or information.
5. When exporting the products or technology described in this document, you should comply with the applicable export control laws and regulations and follow the procedures required by such laws and regulations. You should not use Renesas Electronics products or the technology described in this document for any purpose relating to military applications or use by the military, including but not limited to the development of weapons of mass destruction. Renesas Electronics products and technology may not be used for or incorporated into any products or systems whose manufacture, use, or sale is prohibited under any applicable domestic or foreign laws or regulations.
6. Renesas Electronics has used reasonable care in preparing the information included in this document, but Renesas Electronics does not warrant that such information is error free. Renesas Electronics assumes no liability whatsoever for any damages incurred by you resulting from errors in or omissions from the information included herein.
7. Renesas Electronics products are classified according to the following three quality grades: “Standard”, “High Quality”, and “Specific”. The recommended applications for each Renesas Electronics product depends on the product’s quality grade, as indicated below. You must check the quality grade of each Renesas Electronics product before using it in a particular application. You may not use any Renesas Electronics product for any application categorized as “Specific” without the prior written consent of Renesas Electronics. Further, you may not use any Renesas Electronics product for any application for which it is not intended without the prior written consent of Renesas Electronics. Renesas Electronics shall not be in any way liable for any damages or losses incurred by you or third parties arising from the use of any Renesas Electronics product for an application categorized as “Specific” or for which the product is not intended where you have failed to obtain the prior written consent of Renesas Electronics. The quality grade of each Renesas Electronics product is “Standard” unless otherwise expressly specified in a Renesas Electronics data sheets or data books, etc.
  - “Standard”: Computers; office equipment; communications equipment; test and measurement equipment; audio and visual equipment; home electronic appliances; machine tools; personal electronic equipment; and industrial robots.
  - “High Quality”: Transportation equipment (automobiles, trains, ships, etc.); traffic control systems; anti-disaster systems; anti-crime systems; safety equipment; and medical equipment not specifically designed for life support.
  - “Specific”: Aircraft; aerospace equipment; submersible repeaters; nuclear reactor control systems; medical equipment or systems for life support (e.g. artificial life support devices or systems), surgical implantations, or healthcare intervention (e.g. excision, etc.), and any other applications or purposes that pose a direct threat to human life.
8. You should use the Renesas Electronics products described in this document within the range specified by Renesas Electronics, especially with respect to the maximum rating, operating supply voltage range, movement power voltage range, heat radiation characteristics, installation and other product characteristics. Renesas Electronics shall have no liability for malfunctions or damages arising out of the use of Renesas Electronics products beyond such specified ranges.
9. Although Renesas Electronics endeavors to improve the quality and reliability of its products, semiconductor products have specific characteristics such as the occurrence of failure at a certain rate and malfunctions under certain use conditions. Further, Renesas Electronics products are not subject to radiation resistance design. Please be sure to implement safety measures to guard them against the possibility of physical injury, and injury or damage caused by fire in the event of the failure of a Renesas Electronics product, such as safety design for hardware and software including but not limited to redundancy, fire control and malfunction prevention, appropriate treatment for aging degradation or any other appropriate measures. Because the evaluation of microcomputer software alone is very difficult, please evaluate the safety of the final products or system manufactured by you.
10. Please contact a Renesas Electronics sales office for details as to environmental matters such as the environmental compatibility of each Renesas Electronics product. Please use Renesas Electronics products in compliance with all applicable laws and regulations that regulate the inclusion or use of controlled substances, including without limitation, the EU RoHS Directive. Renesas Electronics assumes no liability for damages or losses occurring as a result of your noncompliance with applicable laws and regulations.
11. This document may not be reproduced or duplicated, in any form, in whole or in part, without prior written consent of Renesas Electronics.
12. Please contact a Renesas Electronics sales office if you have any questions regarding the information contained in this document or Renesas Electronics products, or if you have any other inquiries.

(Note 1) “Renesas Electronics” as used in this document means Renesas Electronics Corporation and also includes its majority-owned subsidiaries.

(Note 2) “Renesas Electronics product(s)” means any product developed or manufactured by or for Renesas Electronics.

SINGLE SUPPLY VOLTAGE, HIGH SPEED,  
WIDE BAND, DUAL OPERATIONAL AMPLIFIERS

DESCRIPTION

The  $\mu$ PC842 is dual high speed, wide band operational amplifier designed for single supply operation from +3 V to +32 V with low supply current drain. By using high speed PNP transistors for input and output circuits, the excellent AC performance is achieved without degrading capacitive load drive capability.

With no crossover distortion and wide output voltage range characteristics, the  $\mu$ PC842 is optimum choice for single supply AC amplifier, and active filters.

FEATURES

- High slew rate: 7 V/ $\mu$ s TYP. ( $V^+ = +5$  V,  $V^- =$  GND)
- Wide gain band width product: 3.5 MHz TYP. ( $V^+ = +5$  V,  $V^- =$  GND)
- Wide supply voltage range: +3 V to +32 V
- Wide output voltage swing
- Common mode input voltage range includes  $V^-$
- Internal frequency compensation
- Output short circuit protection

EQUIVALENT CIRCUIT (1/2 Circuit)

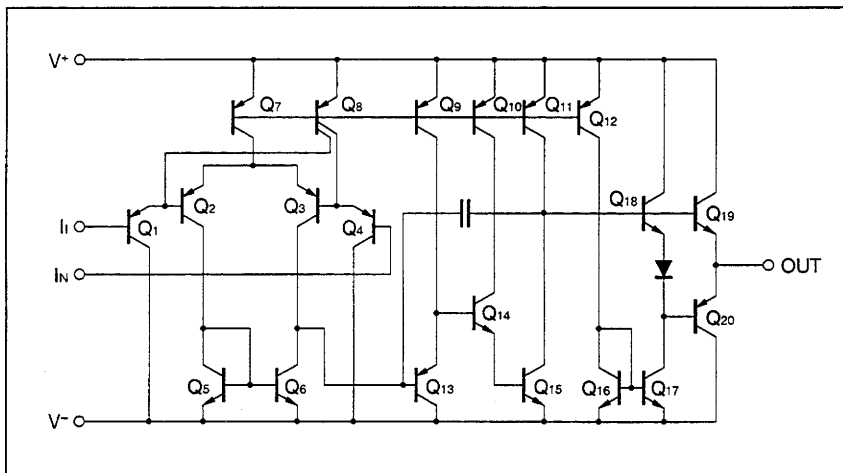

PIN CONFIGURATION (Top View)

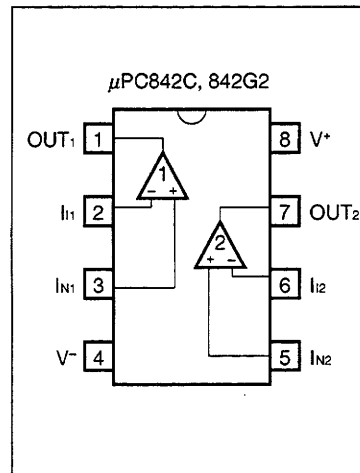

ORDERING INFORMATION

Part Number	Package
$\mu$ PC842C	8-pin plastic DIP (300 mil)
$\mu$ PC842G2	8-pin plastic SOP (225 mil)

The information in this document is subject to change without notice.

**ABSOLUTE MAXIMUM RATINGS (T<sub>A</sub> = 25 °C)**

Parameters		Symbol	Ratings	Unit
Voltage between V <sup>+</sup> and V <sup>-</sup> <b>Note 1</b>		V <sup>+</sup> -V <sup>-</sup>	-0.3 to +36	V
Differential Input Voltage		V <sub>ID</sub>	±36	V
Input Voltage <b>Note 2</b>		V <sub>I</sub>	V <sup>-</sup> -0.3 to V <sup>-</sup> +36	V
Output Voltage <b>Note 3</b>		V <sub>O</sub>	V <sup>-</sup> -0.3 to V <sup>+</sup> +0.3	V
Power Dissipation	C Package <b>Note 4</b>	P <sub>T</sub>	350	mW
	G2 Package <b>Note 5</b>		440	mW
Output Short Circuit Duration <b>Note 6</b>			Indefinite	sec
Operating Ambient Temperature		T <sub>A</sub>	-40 to +85	°C
Storage Temperature		T <sub>stg</sub>	-55 to + 125	°C

- Notes**
- Reverse connection of supply voltage can cause destruction.
  - The input voltage should be allowed to input without damage or destruction independent of the magnitude of V<sup>+</sup>. Either input signal should not be allowed to go negative by more than 0.3 V. The normal operation will establish when the both inputs are within the Common Mode Input Voltage Range of electrical characteristics.
  - This specification is the voltage which should be allowed to supply to the output terminal from external without damage or destructive. Even during the transition period of supply voltage, power on/off etc., this specification should be kept. The output voltage of normal operation will be the Output Voltage Swing of electrical characteristics.
  - Thermal derating factor is -5.0 mW/°C when operating ambient temperature is higher than 55 °C.
  - Thermal derating factor is -4.4 mW/°C when operating ambient temperature is higher than 25 °C.
  - Pay careful attention to the total power dissipation not to exceed the absolute maximum ratings, Note 4 and Note 5.

**RECOMMENDED OPERATING CONDITIONS**

Parameters	Symbol	MIN.	TYP.	MAX.	Unit
Supply Voltage (Split)	V <sup>±</sup>	±1.5		±16	V
Supply Voltage (V <sup>-</sup> = GND)	V <sup>+</sup>	+3		+32	V
Output Current	I <sub>O</sub>			±10	mA
Capacitive Load (A <sub>v</sub> = +1, R <sub>f</sub> = 0 Ω)	C <sub>L</sub>			1000	pF

**ELECTRICAL CHARACTERISTICS (T<sub>A</sub> = 25 °C, V<sup>±</sup> = ±15 V)**

Parameters	Symbol	Conditions	MIN.	TYP.	MAX.	Unit
Input Offset Voltage	V <sub>io</sub>			±1.0	±4.5	mV
Input Offset Current	I <sub>io</sub>			±6	±75	nA
Input Bias Current <b>Note 7</b>	I <sub>b</sub>			140	500	nA
Large Signal Voltage Gain	A <sub>v</sub>	R <sub>L</sub> ≥ 2 kΩ, V <sub>o</sub> = ±10 V	25	300		V/mV
Supply Current	I <sub>cc</sub>	I <sub>o</sub> = 0 A, Both Amplifiers		4.3	5.5	mA
Common Mode Rejection Ratio	CMR		70	86		dB
Supply Voltage Rejection Ratio	SVR		70	93		dB
Output Voltage Swing	V <sub>om</sub>	R <sub>L</sub> ≥ 10 kΩ	±13.7	+14 -14.3		V
Output Voltage Swing	V <sub>om</sub>	R <sub>L</sub> ≥ 2 kΩ	±13.5			V
Common Mode Input Voltage Range	V <sub>ICM</sub>		V <sup>-</sup>		V <sup>+</sup> -1.8	V
Slew Rate (Rise)	SR	A <sub>v</sub> = 1, R <sub>L</sub> ≥ 2 kΩ		8.5		V/μs
Gain Band Width Product	GBW	f <sub>o</sub> = 100 kHz		3.5		MHz
Channel Separation		f = 20 Hz to 20 kHz		120		dB

**ELECTRICAL CHARACTERISTICS (T<sub>A</sub> = 25 °C, V<sup>+</sup> = 5 V, V<sup>-</sup> = GND)**

Parameters	Symbol	Conditions	MIN.	TYP.	MAX.	Unit
Input Offset Voltage	V <sub>io</sub>			±1.0	±5	mV
Input Offset Current	I <sub>io</sub>			±6	±75	nA
Input Bias Current <b>Note 7</b>	I <sub>b</sub>			160	500	nA
Large Signal Voltage Gain	A <sub>v</sub>	R <sub>L</sub> ≥ 2 kΩ	25	300		V/mV
Supply Current	I <sub>cc</sub>	I <sub>o</sub> = 0 A, All Amplifiers		3.3	4.5	mA
Common Mode Rejection Ratio	CMR		70	80		dB
Supply Voltage Rejection Ratio	SVR		70	95		dB
Output Voltage Swing	V <sub>om</sub>	R <sub>L</sub> ≥ 2 kΩ (Connect to GND)	3.7 0	4.0 0		V
Common Mode Input Voltage Range	V <sub>ICM</sub>		0		V <sup>+</sup> -1.8	V
Output Current (SOURCE)	I <sub>o SOURCE</sub>	V <sup>+</sup> <sub>IN</sub> = +1 V, V <sup>-</sup> <sub>IN</sub> = 0 V	10	30		mA
Output Current (SINK)	I <sub>o SINK</sub>	V <sup>+</sup> <sub>IN</sub> = 0 V, V <sup>-</sup> <sub>IN</sub> = +1 V	10	30		mA
Slew Rate (Rise)	SR			7		V/μs

**Notes 7.** Input bias currents flow out from IC. Because each currents are base current of PNP-transistor on input stage.

TYPICAL CHARACTERISTICS (T<sub>A</sub> = 25 °C, TYP.)

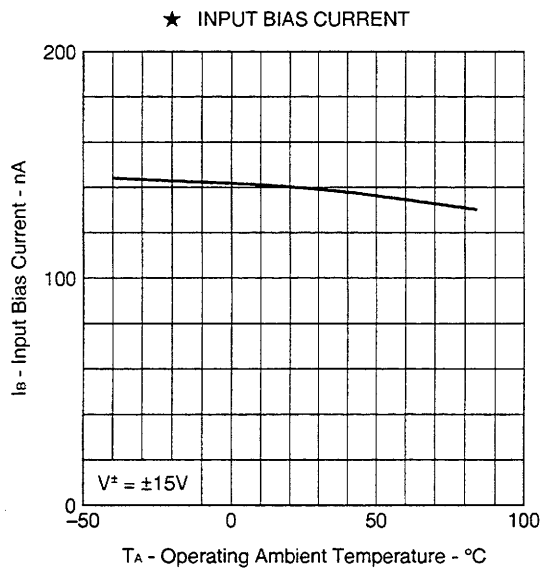
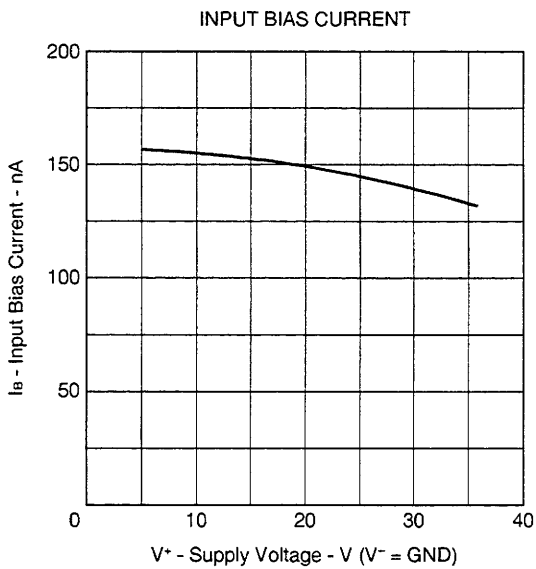
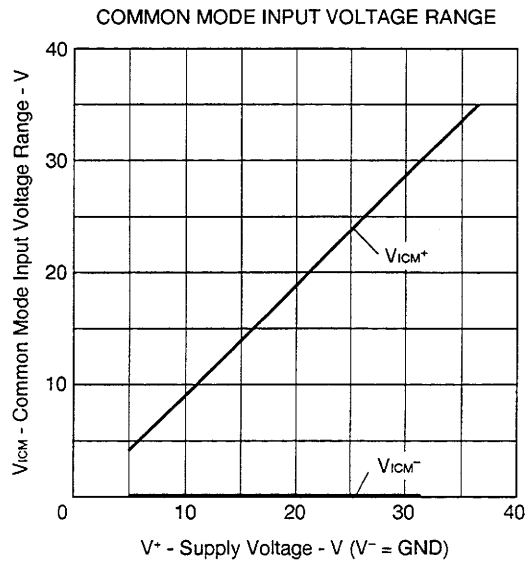
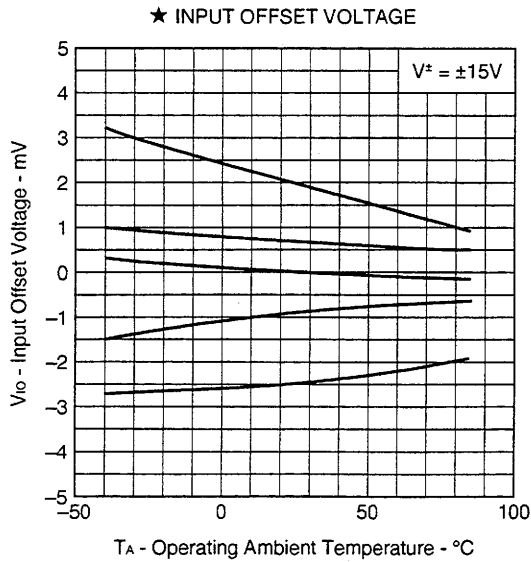
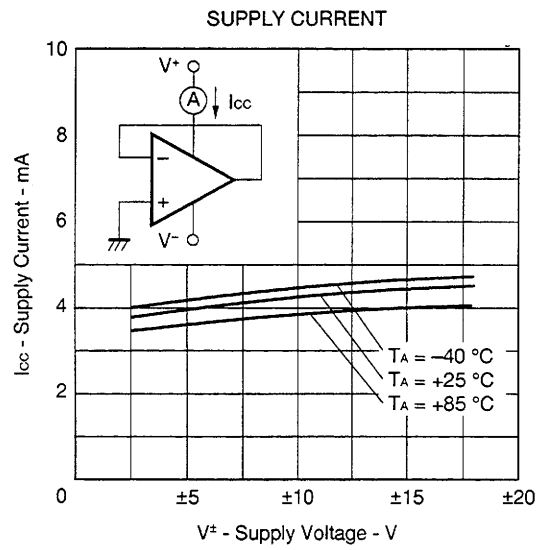
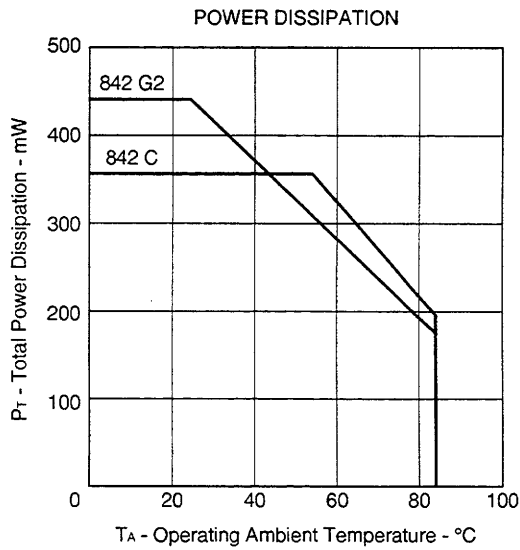

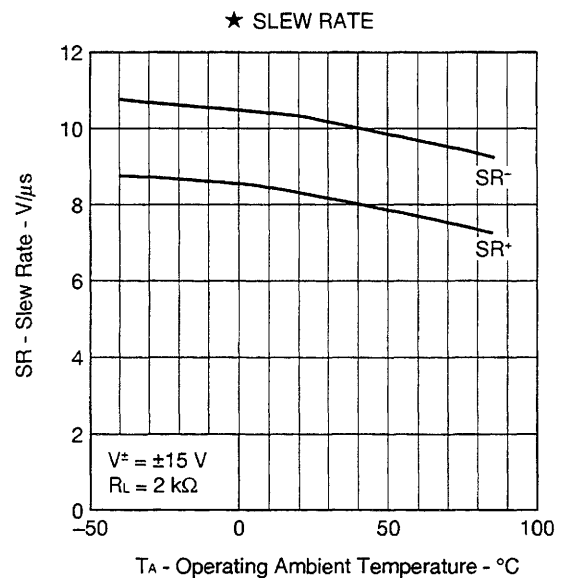
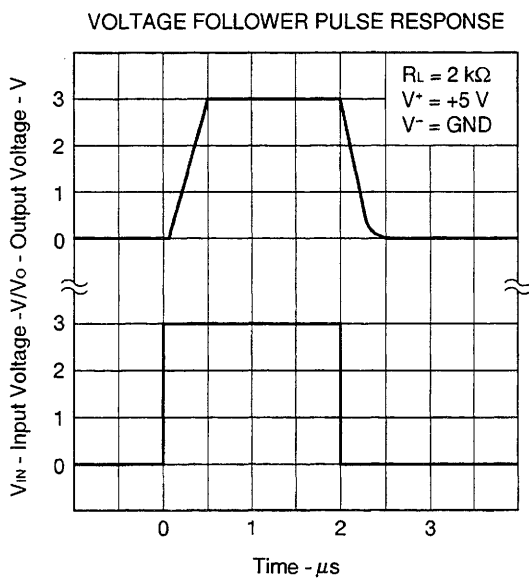
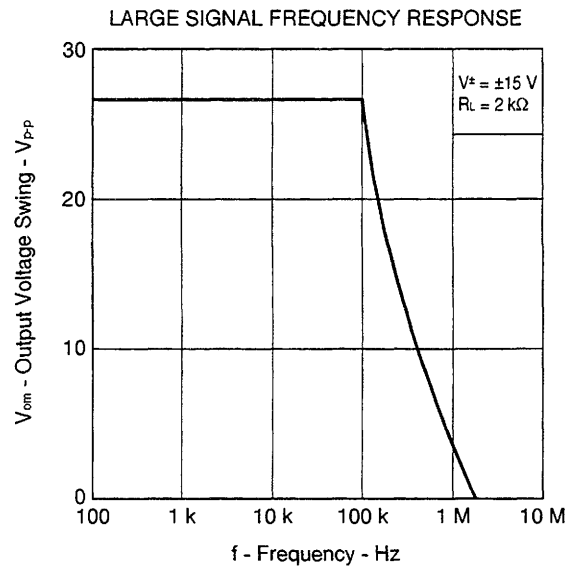
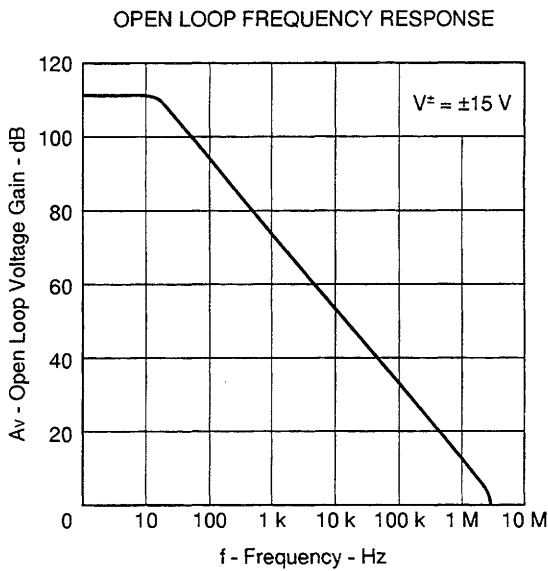
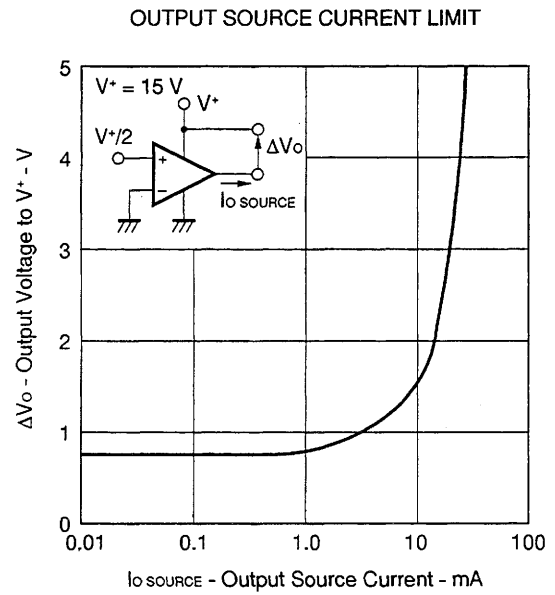
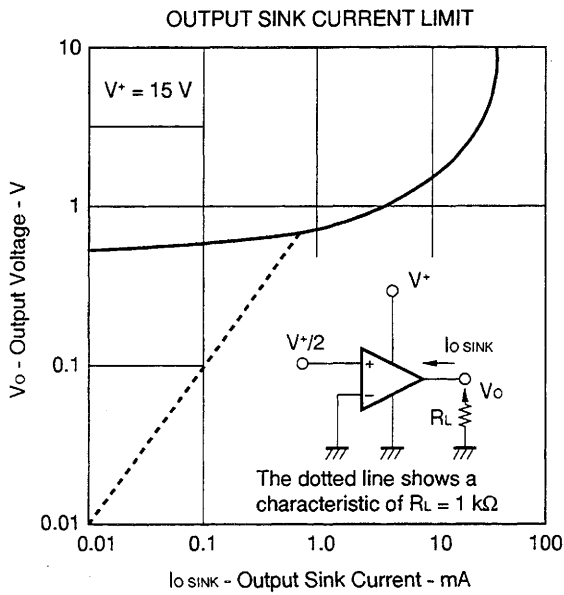

PACKAGE DRAWINGS

8PIN PLASTIC DIP (300 mil)

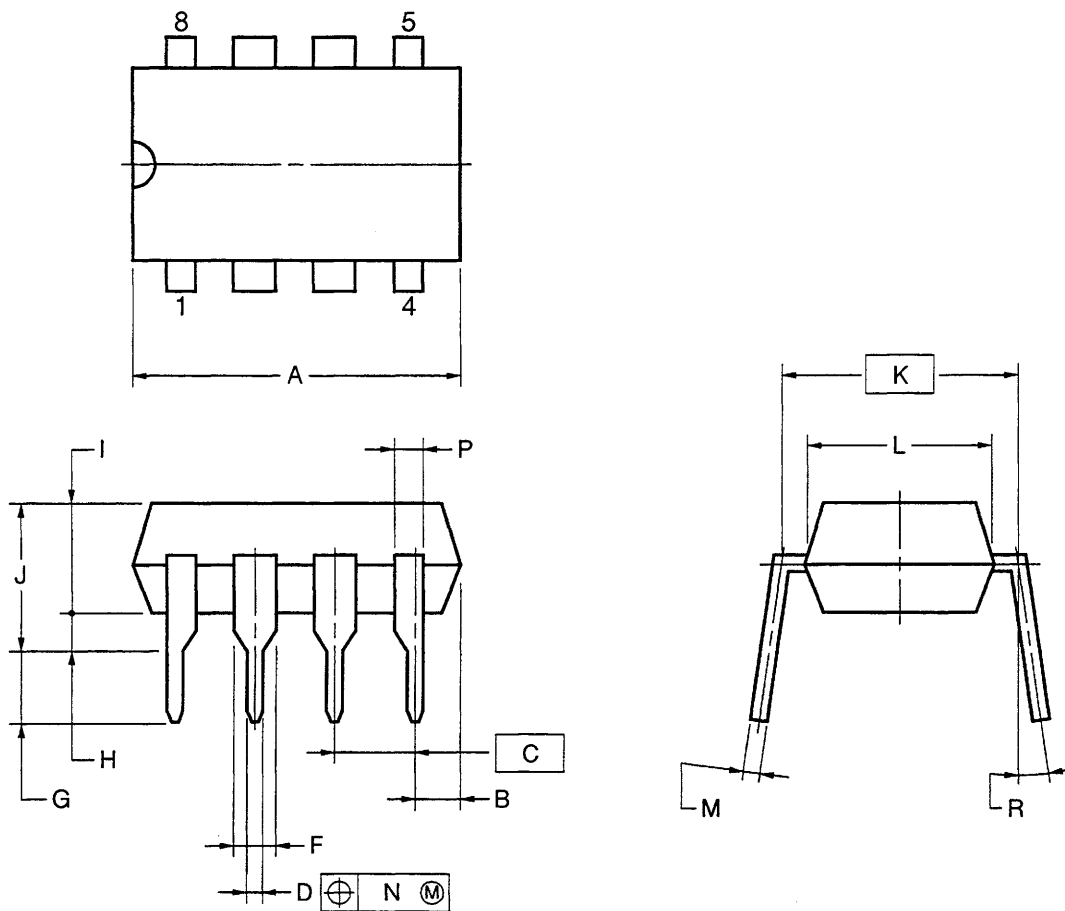

NOTES

- 1) Each lead centerline is located within 0.25 mm (0.01 inch) of its true position (T.P.) at maximum material condition.
- 2) Item "K" to center of leads when formed parallel.

ITEM	MILLIMETERS	INCHES
A	10.16 MAX.	0.400 MAX.
B	1.27 MAX.	0.050 MAX.
C	2.54 (T.P.)	0.100 (T.P.)
D	0.50±0.10	0.020 <sup>+0.004</sup> <sub>-0.005</sub>
F	1.4 MIN.	0.055 MIN.
G	3.2±0.3	0.126±0.012
H	0.51 MIN.	0.020 MIN.
I	4.31 MAX.	0.170 MAX.
J	5.08 MAX.	0.200 MAX.
K	7.62 (T.P.)	0.300 (T.P.)
L	6.4	0.252
M	0.25 <sup>+0.10</sup> <sub>-0.05</sub>	0.010 <sup>+0.004</sup> <sub>-0.003</sub>
N	0.25	0.01
P	0.9 MIN.	0.035 MIN.
R	0~15°	0~15°

P8C-100-300B,C-1



8 PIN PLASTIC SOP (225 mil)

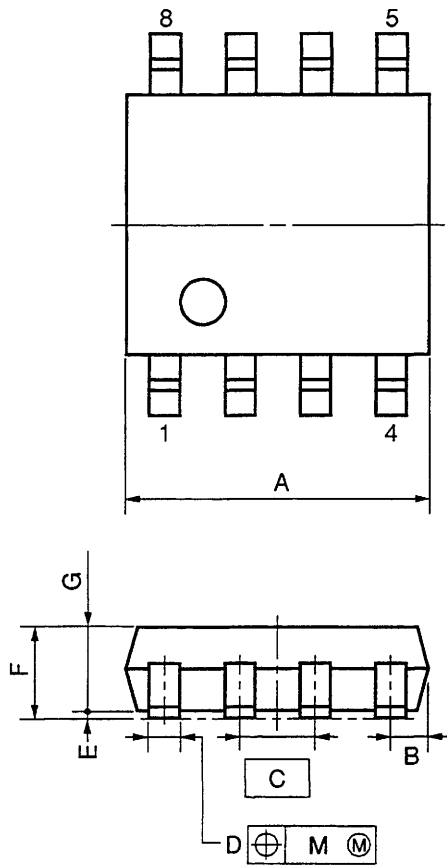

detail of lead end

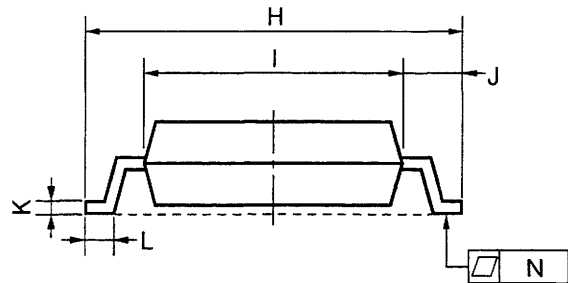
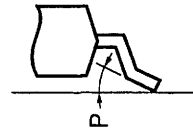

NOTE

Each lead centerline is located within 0.12 mm (0.005 inch) of its true position (T.P.) at maximum material condition.

ITEM	MILLIMETERS	INCHES
A	5.37 MAX.	0.212 MAX.
B	0.78 MAX.	0.031 MAX.
C	1.27 (T.P.)	0.050 (T.P.)
D	0.40 <sup>+0.10</sup> <sub>-0.05</sub>	0.016 <sup>+0.004</sup> <sub>-0.003</sub>
E	0.1±0.1	0.004±0.004
F	1.8 MAX.	0.071 MAX.
G	1.49	0.059
H	6.5±0.3	0.256±0.012
I	4.4	0.173
J	1.1	0.043
K	0.15 <sup>+0.10</sup> <sub>-0.05</sub>	0.006 <sup>+0.004</sup> <sub>-0.002</sub>
L	0.6±0.2	0.024 <sup>+0.008</sup> <sub>-0.009</sub>
M	0.12	0.005
N	0.10	0.004
P	3° <sup>+7°</sup> <sub>-3°</sub>	3° <sup>+7°</sup> <sub>-3°</sub>

S8GM-50-225B-4

**RECOMMENDED SOLDERING CONDITIONS**

When soldering this product, it is highly recommended to observe the conditions as shown below. If other soldering processes are used, or if the soldering is performed under different conditions, please make sure to consult with our sales offices.

For more details, refer to our document “Semiconductor Device Mounting Technology Manual” (C10535E).

**Type of Surface Mount Device**

**μPC842G2: 8-pin plastic SOP (225 mil)**

Process	Conditions	Symbol
Infrared ray reflow	Peak temperature: 230 °C or below (Package surface temperature), Reflow time: 30 seconds or less (at 210 °C or higher), Maximum number of reflow processes: 1 time.	IR30-00-1
Vapor Phase Soldering	Peak temperature: 215 °C or below (Package surface temperature), Reflow time: 40 seconds or less (at 200 °C or higher), Maximum number of reflow processes: 1 time.	VP15-00-1
Wave Soldering	Solder temperature: 260 °C or below, Flow time: 10 seconds or less, Maximum number of flow processes: 1 time, Pre-heating temperature: 120 °C or below (Package surface temperature).	WS60-00-1
Partial heating method	Pin temperature: 300 °C or below, Heat time: 3 seconds or less (Per each side of the device).	—

**Caution** Apply only one kind of soldering condition to a device, except for “partial heating method”, or the device will be damaged by heat stress.

**Type of Through-hole Device**

**μPC842C: 8-pin plastic DIP (300 mil)**

Process	Conditions
Wave soldering (only to leads)	Solder temperature: 260 °C or below, Flow time: 10 seconds or less.
Partial heating method	Pin temperature: 300 °C or below, Heat time: 3 seconds or less (per each lead).

**Caution** For through-hole device, the wave soldering process must be applied only to leads, and make sure that the package body does not get jet soldered.

**REFERENCE DOCUMENTS**

QUALITY GRADES ON NEC SEMICONDUCTOR DEVICES	C11531E
SEMICONDUCTOR DEVICE MOUNTING TECHNOLOGY MANUAL	C10535E
IC PACKAGE MANUAL	C10943X
GUIDE TO QUALITY ASSUARANCE FOR SEMICONDUCTOR DEVICES	MEI-1202
SEMICONDUCTORS SELECTION GUIDE	X10679E
NEC SEMICONDUCTOR DEVICE RELIABILITY/ QUALITY CONTROL SYSTEM - STANDARD LINEAR IC	IEI-1212

[MEMO]

[MEMO]

## [MEMO]

No part of this document may be copied or reproduced in any form or by any means without the prior written consent of NEC Corporation. NEC Corporation assumes no responsibility for any errors which may appear in this document.

NEC Corporation does not assume any liability for infringement of patents, copyrights or other intellectual property rights of third parties by or arising from use of a device described herein or any other liability arising from use of such device. No license, either express, implied or otherwise, is granted under any patents, copyrights or other intellectual property rights of NEC Corporation or others.

While NEC Corporation has been making continuous effort to enhance the reliability of its semiconductor devices, the possibility of defects cannot be eliminated entirely. To minimize risks of damage or injury to persons or property arising from a defect in an NEC semiconductor device, customers must incorporate sufficient safety measures in its design, such as redundancy, fire-containment, and anti-failure features.

NEC devices are classified into the following three quality grades:

"Standard", "Special", and "Specific". The Specific quality grade applies only to devices developed based on a customer designated "quality assurance program" for a specific application. The recommended applications of a device depend on its quality grade, as indicated below. Customers must check the quality grade of each device before using it in a particular application.

Standard: Computers, office equipment, communications equipment, test and measurement equipment, audio and visual equipment, home electronic appliances, machine tools, personal electronic equipment and industrial robots

Special: Transportation equipment (automobiles, trains, ships, etc.), traffic control systems, anti-disaster systems, anti-crime systems, safety equipment and medical equipment (not specifically designed for life support)

Specific: Aircrafts, aerospace equipment, submersible repeaters, nuclear reactor control systems, life support systems or medical equipment for life support, etc.

The quality grade of NEC devices is "Standard" unless otherwise specified in NEC's Data Sheets or Data Books. If customers intend to use NEC devices for applications other than those specified for Standard quality grade, they should contact an NEC sales representative in advance.

Anti-radioactive design is not implemented in this product.