

ISL6446ADEMO1Z

Dual Channel Step Down Regulator Evaluation Board

AN1822
Rev 1.00
May 7, 2015

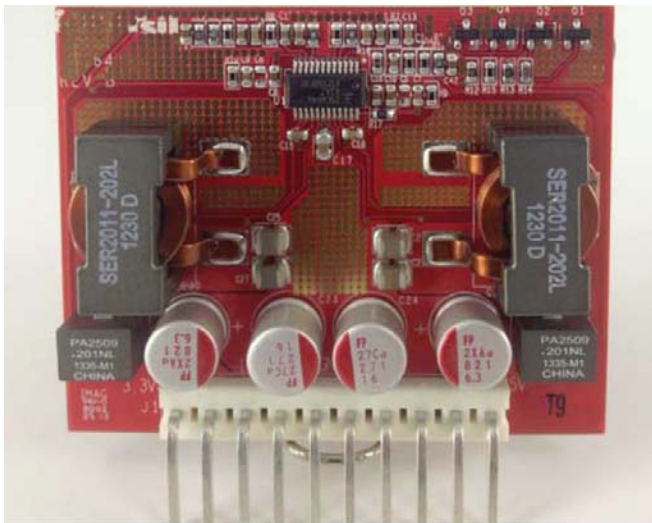

FIGURE 1. ISL6446ADEMO1Z REV B BOARD



FIGURE 2. ISL6446ADEMO1Z REV B BOARD BACKSIDE

Introduction

The [ISL6446A](#) is a high performance Dual PWM + Single Linear Controller. This device integrates complete control, monitoring and protection functions for two synchronous buck PWM controllers and one low power linear controller. Each PWM channel is switched 180° out-of-phase for reduced input ripple current and lower EMI.

The PWM controller uses voltage mode control for simple output regulation. The output can be regulated from $0.8 \cdot V_{IN}$ down to the 0.6V reference voltage. Switching frequency is programmable from 100kHz to 2.5MHz, providing either a cost optimized or compact power solution.

The ISL6446ADEMO1Z demo board is designed as an easy to use, dual output, non-isolated power module featuring synchronous buck function. It is well suited for any applications that require high performance, small space and low cost. The ISL6446ADEMO1Z output voltage is preset to 3.3V and 5V targeting ATX power supply applications. Each channel is designed for up to 20A of output current. Total power of the demo board is limited by thermal conditions.

Evaluation Board Features

- 12V input voltage
- Preset +5V and +3.3V output
- 20A output current each channel
- Two-in-1 PWM controller with out-of-phase operation
- Voltage-mode PWM control
- Efficiency up to 94.9%
- Prebias start-up
- Undervoltage lockout
- Output overcurrent protection
- Over-temperature protection
- f_{sw} set at 280kHz
- Simple dual layer board design

Evaluation Board Specifications

SYMBOL	PARAMETER	TEST CONDITIONS	MIN	TYP	MAX	UNIT
V_{IN}	Input Range	Over I_O range	10.8		13.2	V
V_{OUT1}	Output Range	Over I_O range	4.8	5	5.2	V
I_{OUT1}	Output Current	From no load to full load	0		20	A
V_{OUT2}	Output Range	Over I_O range	3.1	3.3	3.5	V
I_{OUT2}	Output Current	From no load to full load	0		20	A

Table of Contents

Introduction	1
Evaluation Board Features	1
Evaluation Board Specifications	1
Terminal Functions	3
Undervoltage Lockout Circuit	3
ISL6446ADEMO1Z Schematic	5
PCB Layout	6
ISL6446ADEMO1Z Bill of Materials	7
ISL6446ADEMO1Z Test Report	8
Efficiency Curves	9
Steady State Operation	9
Protection	11

Equipment Used for Validation

- 12V/200W input power source
- Dual channel electronic load

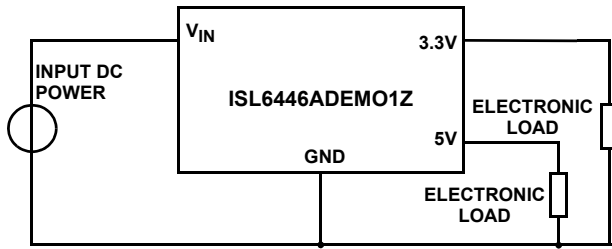

FIGURE 3. TYPICAL APPLICATION DIAGRAM

Terminal Functions

TABLE 1. TERMINAL FUNCTIONS

TERMINAL NAME	DESCRIPTION
V _{IN}	The positive input voltage node to the module, which is referenced to common GND.
GND	This is the common ground connection for the V _{IN} and V _{OUT} power connection.
5V	The regulated positive 5V power output with respect to the GND node.
3.3V	The regulated positive 3.3V power output with respect to the GND node.

Getting Started

Using short twisted pair leads for any power connections and with all loads and power supplies off, refer to [Figure 4](#) for the proper measurement and equipment setup. The Power Supply (PS) should not be connected to the circuit until told to do so in the following procedure.

When measuring the input or output voltage ripple, care must be taken to avoid a long ground lead on the oscilloscope probe. Measure the input or output voltage ripple by touching the probe tip directly across V_{OUT} and GND terminals.

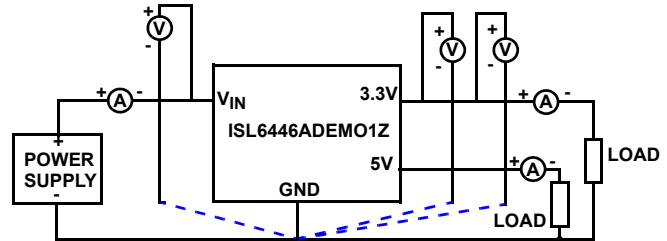

FIGURE 4. CONNECTION DIAGRAM

1. Keep the power supply and electronic load power off.
2. Connect the power supply; electronic load; voltage and current meters. [Figure 4](#) shows while keeping the power supply and load shut down.
3. Turn on the power supply and set the input voltage to 12V. Monitor input current. If input current exceeds 100mA, turn off power supply and look for shorts.
4. Confirm $V_{OUT1} = 3.3V$, $V_{OUT2} = 5V$
5. Slowly increase the load on V_{OUT} to 15A. Verify $V_{OUT1} = 3.3V$, $V_{OUT2} = 5V$

The board is now ready for operation.

Undervoltage Lockout Circuit

The ISL6446ADEMO1Z demo board includes as part of its circuitry a UVLO (Undervoltage Lockout) circuit that prevents it from starting up with V_{IN} voltages less than about 7.8V. If you want to reduce the UVLO voltage, (resistor R₁₂ in the schematic of the board) it needs to be reduced in value.

Board Electrical Specifications $T_A = +25^\circ\text{C}$; $V_{IN} = 12\text{V}$; $V_{OUT1} = 3.3\text{V}$, $V_{OUT2} = 5\text{V}$, and $I_{OUT1} = 15\text{A}$, $I_{OUT2} = 15\text{A}$
(unless otherwise noted).

SYMBOL	PARAMETER	TEST CONDITIONS	MIN	TYP	MAX	UNIT
V_{IN}	Input Range	Over I_O range	10.8		13.2	V
V_{OUT1}	Output Range	Over I_O range	4.8	5	5.2	V
I_{O1}	Output Current	From no load to full load	0		20	A
V_{OUT2}	Output Range	Over I_O range	3.1	3.3	3.5	V
I_{O2}	Output Current	From no load to full load	0		20	A
η	Efficiency for DC/DC	$V_{IN} = 12\text{V}$ (Note 1)	$I_{OUT1} = I_{OUT2} = 2\text{A}$	93.39		%
			$I_{OUT1} = I_{OUT2} = 4\text{A}$	95.18		%
			$I_{OUT1} = I_{OUT2} = 8\text{A}$	95.87		%
			$I_{OUT1} = I_{OUT2} = 12\text{A}$	95.53		%
			$I_{OUT1} = I_{OUT2} = 16\text{A}$	94.88		%
			$I_{OUT1} = I_{OUT2} = 20\text{A}$	93.99		%
V_{r1}	V_{OUT1} Ripple (Peak-to-peak)	No load		30		mV _{p-p}
		Full load		50		mV _{p-p}
V_{r2}	V_{OUT2} Ripple (Peak-to-peak)	No load		30		mV _{p-p}
		Full Load		50		mV _{p-p}
V_{T1}	Transient (Peak-to-peak)	Output peak-to-peak voltage variation when output current changing from 5A to 10A with 2.5A/ μs slew rate		250		mV
V_{T2}	Transient (Peak-to-peak)	Output peak-to-peak voltage variation when output current changing from 5A to 10A with 2.5A/ μs slew rate		250		mV
F_s	Switching Frequency	Over V_{IN} and I_O range		280		kHz

NOTE:

- For the efficiency test result please refer to [page 11](#).

ISL6446ADEMO1Z Schematic

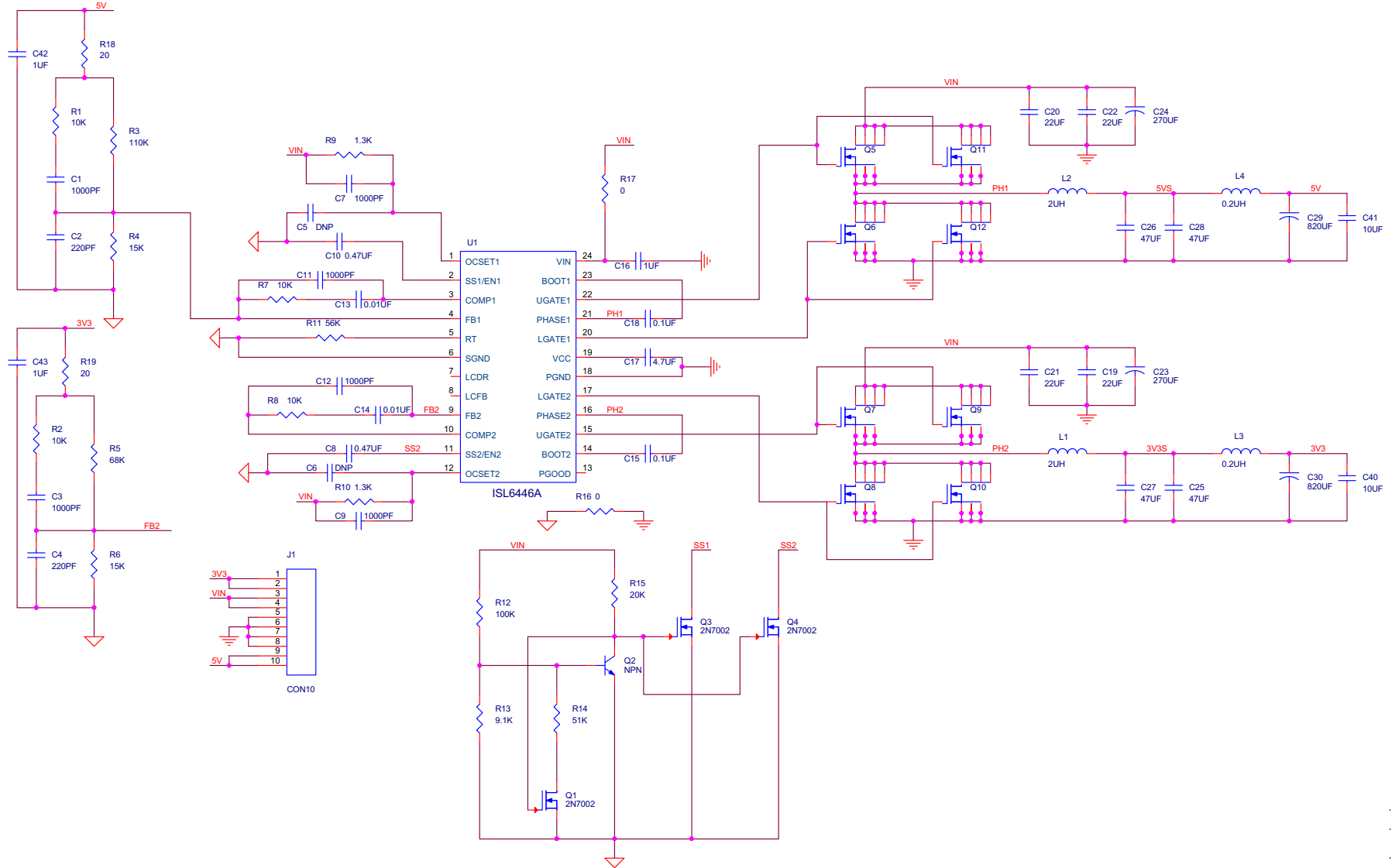

FIGURE 5. ISL6446ADEMO1Z SCHEMATIC

PCB Layout

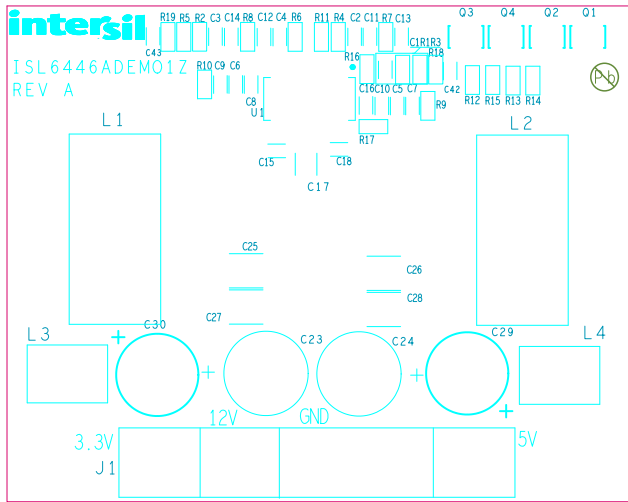

FIGURE 6. SILK SCREEN TOP

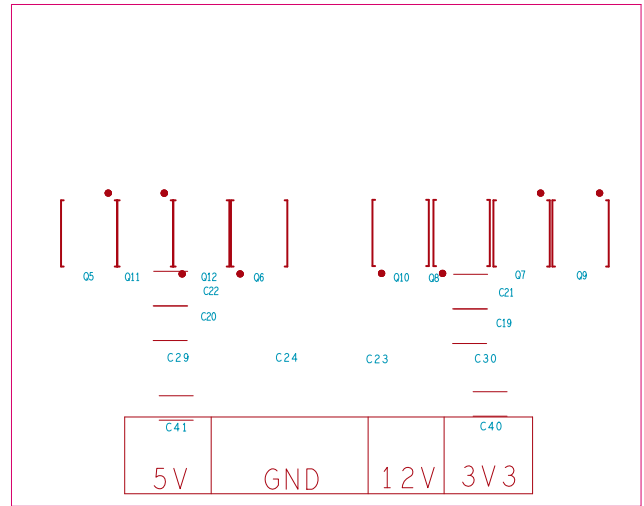

FIGURE 7. SILK SCREEN BOTTOM

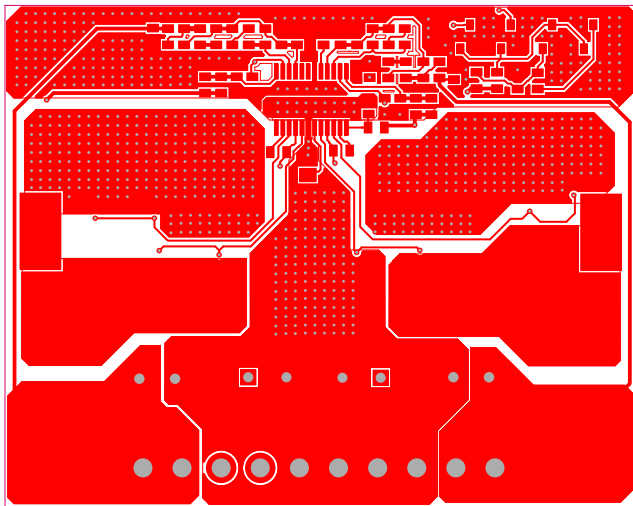

FIGURE 8. PCB TOP

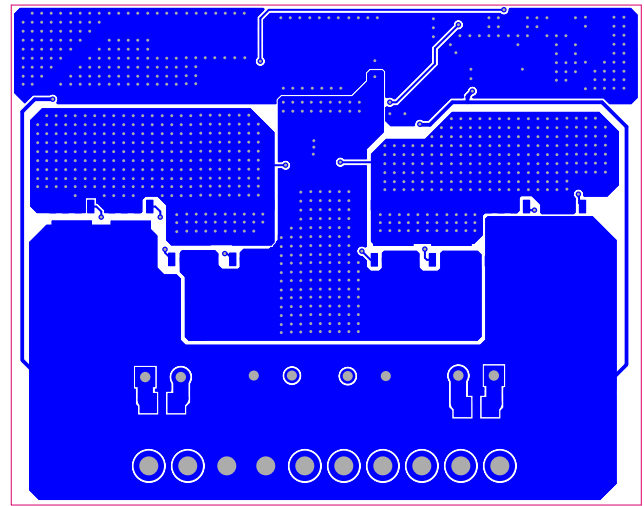

FIGURE 9. PCB BOTTOM

ISL6446ADEMO1Z Bill of Materials

MANUFACTURER PART	QTY	UNIT S	REFERENCE DESIGNATOR	DESCRIPTION	MANUFACTURER
ISL6446ADEMO1ZREVBPCB	1	ea.		PWB-PCB, ISL6446ADEMO1Z, REVB, ROHS	IMAGINEERING INC
06035C102KAT2A	6	ea.	C1, C3, C7, C9, C11, C12	CAP, SMD, 0603, 1000pF, 50V, 10%, X7R, ROHS	AVX
GRM39X7R103K050	2	ea.	C13, C14	CAP, SMD, 0603, 0.01μF, 50V, 10%, X7R, ROHS	MURATA
GRM39X7R104K025AD	2	ea.	C15, C18	CAP, SMD, 0603, 0.1μF, 25V, 10%, X7R, ROHS	MURATA
GRM188R61C105KA12D	3	ea.	C16, C42, C43	CAP, SMD, 0603, 1μF, 16V, 10%, X5R, ROHS	MURATA
GRM188R71H221KA01D	2	ea.	C2, C4	CAP, SMD, 0603, 220pF, 50V, 10%, X7R, ROHS	MURATA
C1608X7R1C474K	2	ea.	C8, C10	CAP, SMD, 0603, 0.47μF, 16V, 10%, X7R, ROHS	TDK
ECJ-2FB1C475K	1	ea.	C17	CAP, SMD, 0805, 4.7μF, 16V, 10%, X5R, ROHS	PANASONIC
C1206X7R100-106KNE	2	ea.	C40, C41	CAP, SMD, 1206, 10μF, 10V, 10%, X7R, ROHS	VENKEL
GRM32ER71C226KE18L	4	ea.	C19, C20, C21, C22	CAP, SMD, 1210, 22μF, 16V, 10%, X7R, ROHS	MURATA
ECJ-4YB0J476M	4	ea.	C25, C26, C27, C28	CAP, SMD, 1210, 47μF, 6.3V, 20%, X5R, ROHS	PANASONIC
PA2509.201NL	2	ea.	L3, L4	COIL-PWR INDUCTOR, SMD, 7X8.5, 0.2μH, 12%, 32A, 0.35mΩ, ROHS	PULSE
RL80J821MDN1KX	2	ea.	C29, C30	CAP, TH, RADIAL, 820μF, 6.3V, 20%, ALUM.POLYMER, 3.5mmLS, ROHS	NICHICON
RL81C271MDN1KX	2	ea.	C23, C24	CAP, TH, RADIAL, 270μF, 16V, 20%, ALUM.POLYMER, 3.5mmLS, ROHS	NICHICON
SER2011-202MLB	2	ea.	L1, L2	COIL-PWR INDUCTOR, SMD, 18.7X19.1, 2.0μH, 20%, 37A, 1.2mΩ, ROHS	COILCRAFT
1-640385-0	1	ea.	J1	CONN-HEADER, TH, 1X10, NYLON, R/A, 0.156mmPITCH, ROHS	TE CONNECTIVITY
ISL6446AIAZ	1	ea.	U1	IC-DUAL PWM/LINEAR CONTROLLER, 24P, QSOP, ROHS	INTERSIL
2N7002-7-F	3	ea.	Q1, Q3, Q4	TRANSISTOR, N-CHANNEL, 3LD, SOT-23, 60V, 115mA, ROHS	DIODES, INC.
BSC010NE2LS	4	ea.	Q7, Q8, Q11, Q12	TRANSIST-MOS, N-CHANNEL, 8P, PG-TDSON-8, 25V, 100A, ROHS	INFINEON TECHNOLOGY
MMBT3904	1	ea.	Q2	TRANSISTOR-NPN, SMD, SOT-23, 40V, 200mA, 350mW, ROHS	FAIRCHILD
ERJ-3EKF20R0V	2	ea.	R18, R19	RES, SMD, 0603, 20Ω, 1/10W, 1%, TF, ROHS	PANASONIC
CR0603-10W-000T	2	ea.	R16, R17	RES, SMD, 0603, 0Ω, 1/10W, TF, ROHS	VENKEL
RK73H1JT1002F	4	ea.	R1, R2, R7, R8	RES, SMD, 0603, 10k, 1/10W, 1%, TF, ROHS	KOA
CR0603-10W-1003FT	1	ea.	R12	RES, SMD, 0603, 100k, 1/10W, 1%, TF, ROHS	VENKEL
ERJ-3EKF1103V	1	ea.	R3	RES, SMD, 0603, 110k, 1/10W, 1%, TF, ROHS	PANASONIC
CRCW06031K30FKTA	2	ea.	R9, R10	RES, SMD, 0603, 1.3k, 1/10W, 1%, TF, ROHS	VISHAY/DALE
ERJ-3EKF1502V	2	ea.	R4, R6	RES, SMD, 0603, 15k, 1/10W, 1%, TF, ROHS	PANASONIC
CR0603-10W-2002FT	1	ea.	R15	RES, SMD, 0603, 20k, 1/10W, 1%, TF, ROHS	VENKEL
RC0603FR-0751KL	1	ea.	R14	RES, SMD, 0603, 51k, 1/10W, 1%, TF, ROHS	YAGEO
ERJ-3EKF5602V	1	ea.	R11	RES, SMD, 0603, 56k, 1/10W, 1%, TF, ROHS	PANASONIC
RC0603FR-0768KL	1	ea.	R5	RES, SMD, 0603, 68k, 1/10W, 1%, TF, ROHS	YAGEO
CR0603-10W-9101FT	1	ea.	R13	RES, SMD, 0603, 9.1k, 1/10W, 1%, TF, ROHS	VENKEL
SJ-5003SPBL	4	ea.	Bottom four corners	BUMPS, 0.44inW x 0.20inH, DOMETOP, BLACK	3M

ISL6446ADEMO1Z Test Report

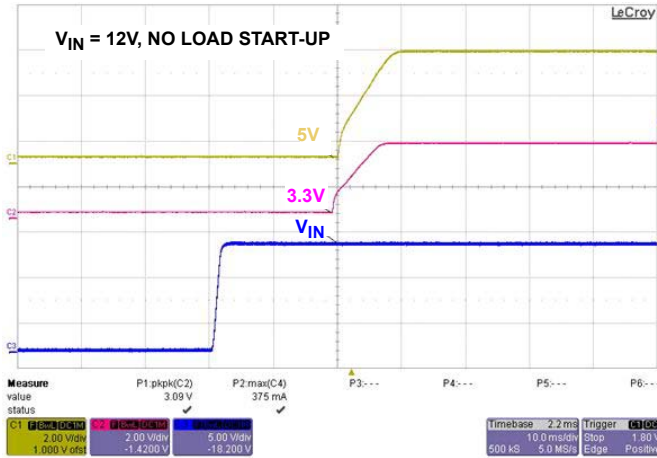

FIGURE 10. START-UP

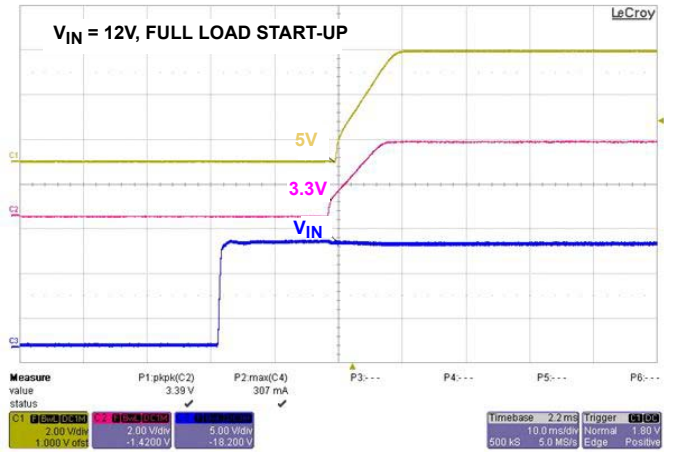

FIGURE 11. START-UP

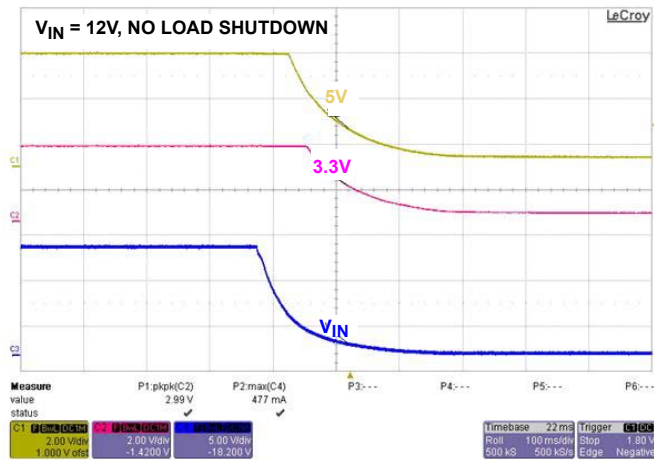

FIGURE 12. SHUTDOWN

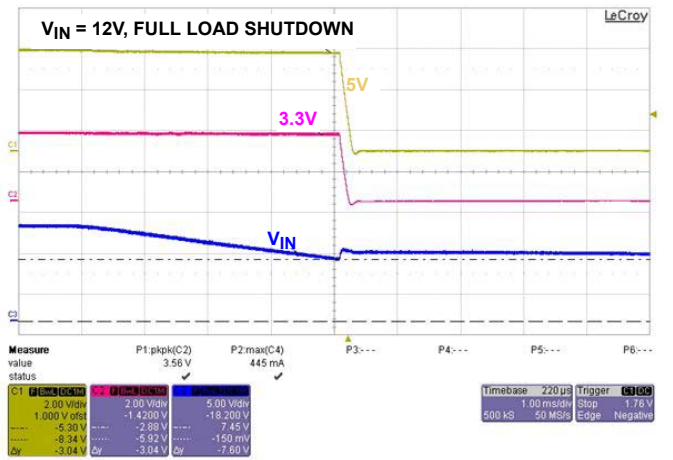

FIGURE 13. SHUTDOWN (UVLO VOLTAGE 7.4V)

Efficiency Curves Input = 12VDC, Output = 5V/20A, 3.3V/20A.

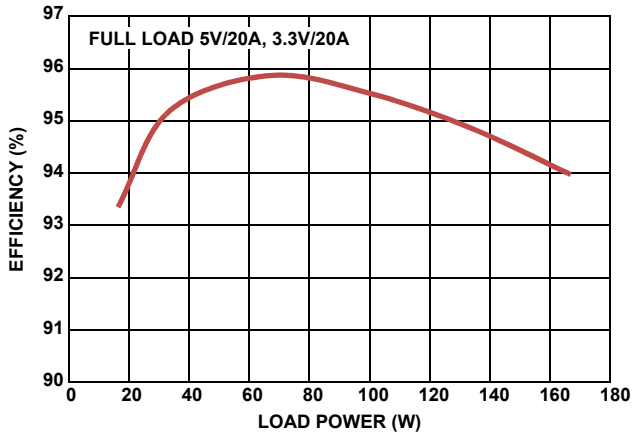

FIGURE 14. EFFICIENCY vs OUTPUT POWER

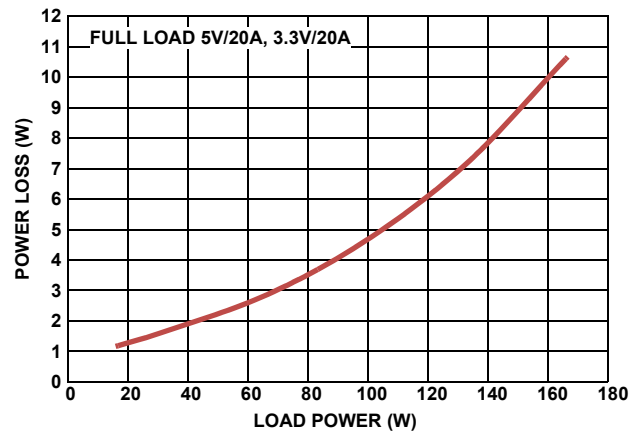

FIGURE 15. POWER LOSS vs OUTPUT POWER

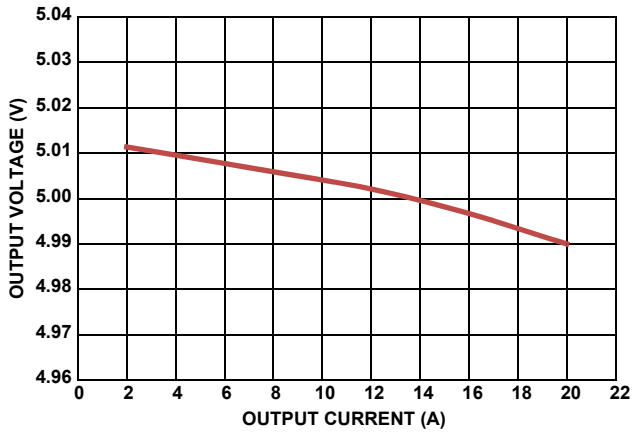

FIGURE 16. OUTPUT LOAD REGULATION 5V

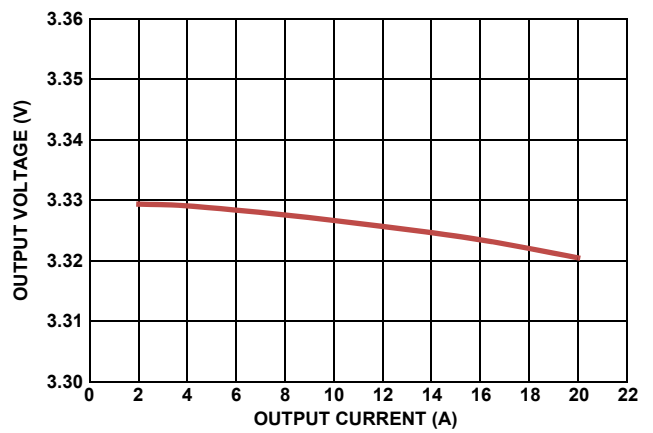

FIGURE 17. OUTPUT LOAD REGULATION 3.3V

Steady State Operation 1st stage LC (2μH + 2*47μF) + 2nd stage LC Output Filters (200nH + 820μF).

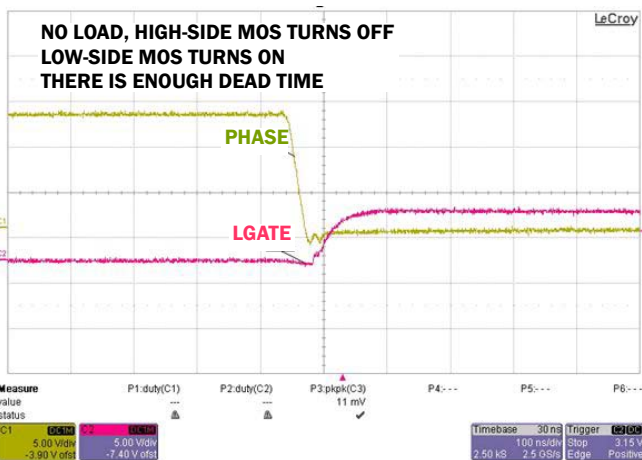

FIGURE 18. GATE DRIVER AND SWITCHING TRANSIENT

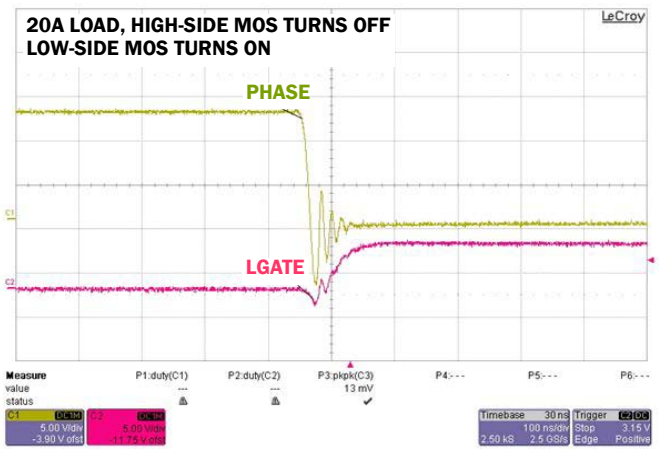

FIGURE 19. GATE DRIVER AND SWITCHING TRANSIENT

Steady State Operation

1st stage LC (2μH + 2*47μF) + 2nd stage LC Output Filters (200nH + 820μF). (Continued)

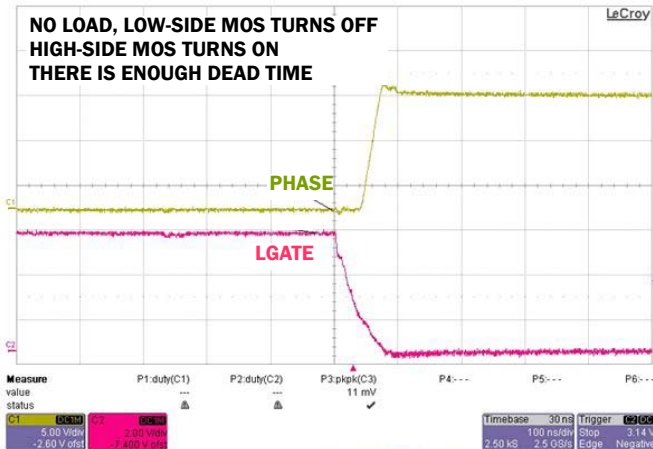

FIGURE 20. GATE DRIVER AND SWITCHING TRANSIENT

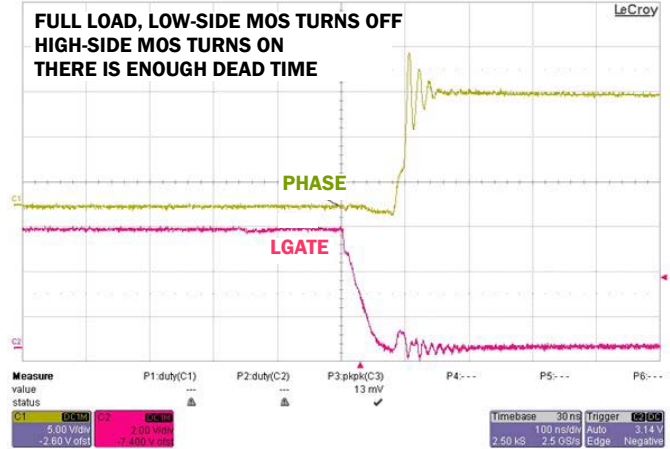

FIGURE 21. GATE DRIVER AND SWITCHING TRANSIENT

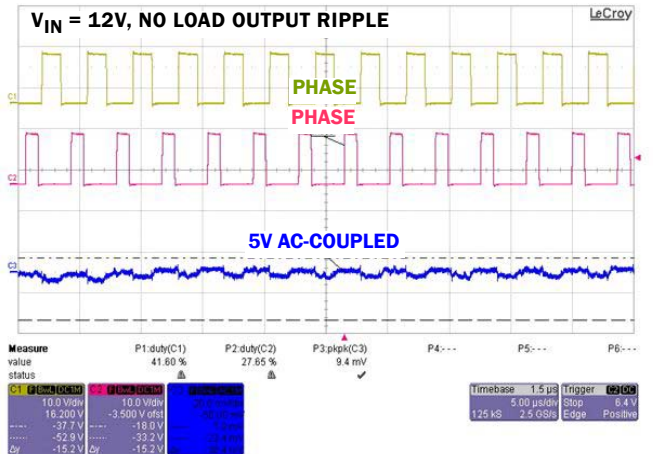

FIGURE 22. 5V NO LOAD OUTPUT RIPPLE 10mV

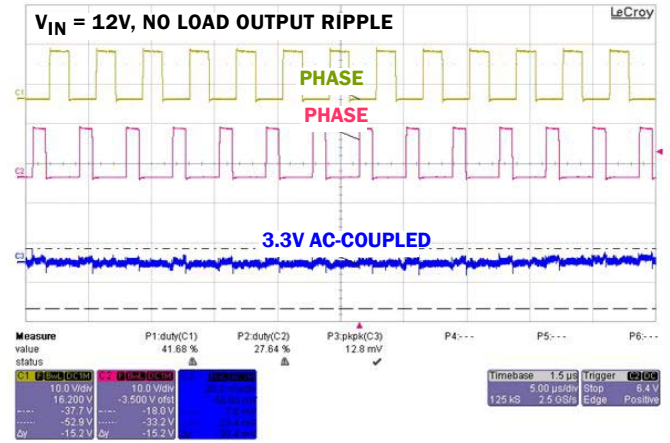

FIGURE 23. 3.3V NO LOAD OUTPUT RIPPLE 13mV

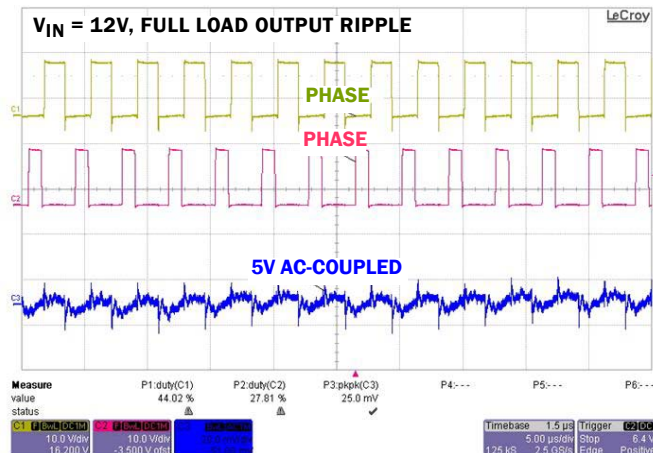

FIGURE 24. 5V FULL LOAD OUTPUT RIPPLE 25mV

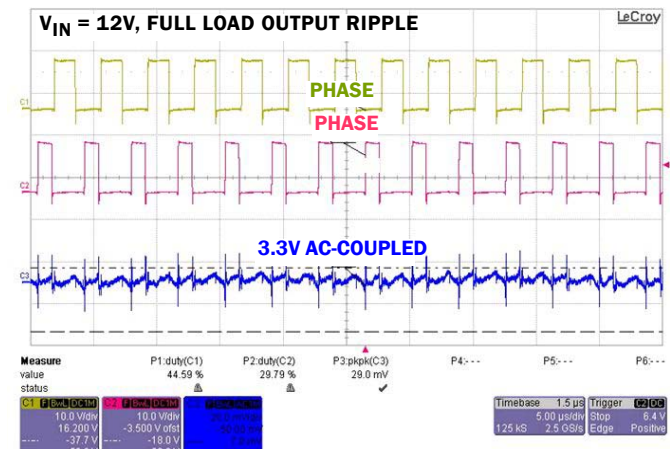

FIGURE 25. 3.3V FULL LOAD OUTPUT RIPPLE 29mV

Output Transient Responses

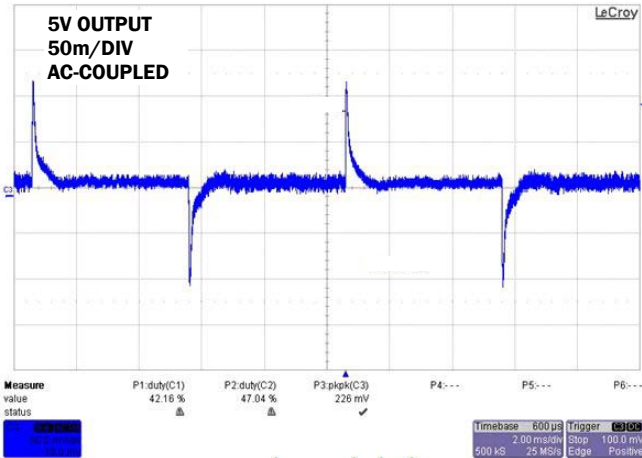

FIGURE 26. 5A~10A, 2.5A/µs, PEAK-TO-PEAK RIPPLE 226mV

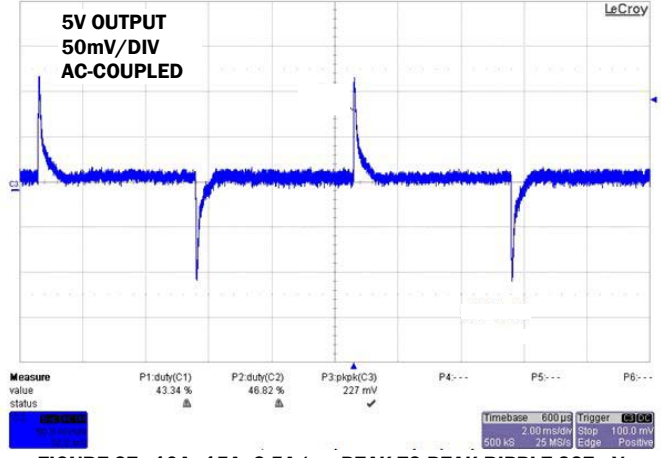

FIGURE 27. 10A~15A, 2.5A/µs, PEAK-TO-PEAK RIPPLE 227mV

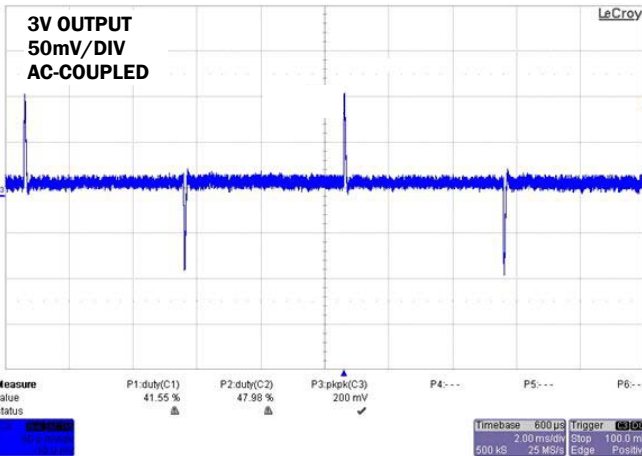

FIGURE 28. 5A~10A, 2.5A/µs, PEAK-TO-PEAK RIPPLE 200mV

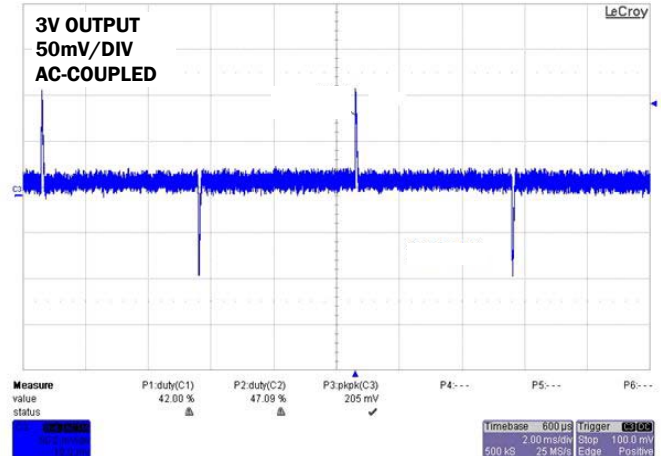

FIGURE 29. 10A~15A, 2.5A/µs, PEAK-TO-PEAK RIPPLE 205mV

Protection

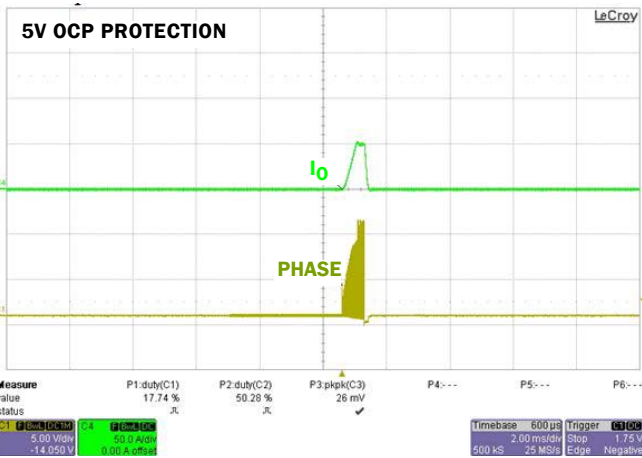

FIGURE 30. OVERCURRENT PROTECTION

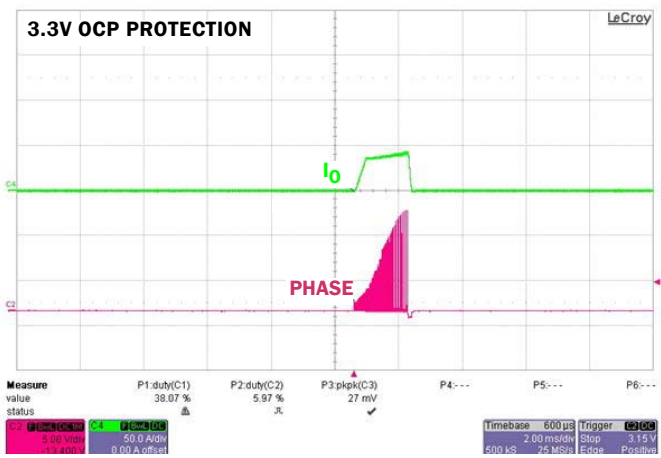

FIGURE 31. OVERCURRENT PROTECTION

Notice

1. Descriptions of circuits, software and other related information in this document are provided only to illustrate the operation of semiconductor products and application examples. You are fully responsible for the incorporation or any other use of the circuits, software, and information in the design of your product or system. Renesas Electronics disclaims any and all liability for any losses and damages incurred by you or third parties arising from the use of these circuits, software, or information.
2. Renesas Electronics hereby expressly disclaims any warranties against and liability for infringement or any other claims involving patents, copyrights, or other intellectual property rights of third parties, by or arising from the use of Renesas Electronics products or technical information described in this document, including but not limited to, the product data, drawings, charts, programs, algorithms, and application examples.
3. No license, express, implied or otherwise, is granted hereby under any patents, copyrights or other intellectual property rights of Renesas Electronics or others.
4. You shall not alter, modify, copy, or reverse engineer any Renesas Electronics product, whether in whole or in part. Renesas Electronics disclaims any and all liability for any losses or damages incurred by you or third parties arising from such alteration, modification, copying or reverse engineering.
5. Renesas Electronics products are classified according to the following two quality grades: "Standard" and "High Quality". The intended applications for each Renesas Electronics product depends on the product's quality grade, as indicated below.
"Standard": Computers; office equipment; communications equipment; test and measurement equipment; audio and visual equipment; home electronic appliances; machine tools; personal electronic equipment; industrial robots; etc.
"High Quality": Transportation equipment (automobiles, trains, ships, etc.); traffic control (traffic lights); large-scale communication equipment; key financial terminal systems; safety control equipment; etc.
Unless expressly designated as a high reliability product or a product for harsh environments in a Renesas Electronics data sheet or other Renesas Electronics document, Renesas Electronics products are not intended or authorized for use in products or systems that may pose a direct threat to human life or bodily injury (artificial life support devices or systems; surgical implantations; etc.), or may cause serious property damage (space system; undersea repeaters; nuclear power control systems; aircraft control systems; key plant systems; military equipment; etc.). Renesas Electronics disclaims any and all liability for any damages or losses incurred by you or any third parties arising from the use of any Renesas Electronics product that is inconsistent with any Renesas Electronics data sheet, user's manual or other Renesas Electronics document.
6. When using Renesas Electronics products, refer to the latest product information (data sheets, user's manuals, application notes, "General Notes for Handling and Using Semiconductor Devices" in the reliability handbook, etc.), and ensure that usage conditions are within the ranges specified by Renesas Electronics with respect to maximum ratings, operating power supply voltage range, heat dissipation characteristics, installation, etc. Renesas Electronics disclaims any and all liability for any malfunctions, failure or accident arising out of the use of Renesas Electronics products outside of such specified ranges.
7. Although Renesas Electronics endeavors to improve the quality and reliability of Renesas Electronics products, semiconductor products have specific characteristics, such as the occurrence of failure at a certain rate and malfunctions under certain use conditions. Unless designated as a high reliability product or a product for harsh environments in a Renesas Electronics data sheet or other Renesas Electronics document, Renesas Electronics products are not subject to radiation resistance design. You are responsible for implementing safety measures to guard against the possibility of bodily injury, injury or damage caused by fire, and/or danger to the public in the event of a failure or malfunction of Renesas Electronics products, such as safety design for hardware and software, including but not limited to redundancy, fire control and malfunction prevention, appropriate treatment for aging degradation or any other appropriate measures. Because the evaluation of microcomputer software alone is very difficult and impractical, you are responsible for evaluating the safety of the final products or systems manufactured by you.
8. Please contact a Renesas Electronics sales office for details as to environmental matters such as the environmental compatibility of each Renesas Electronics product. You are responsible for carefully and sufficiently investigating applicable laws and regulations that regulate the inclusion or use of controlled substances, including without limitation, the EU RoHS Directive, and using Renesas Electronics products in compliance with all these applicable laws and regulations. Renesas Electronics disclaims any and all liability for damages or losses occurring as a result of your noncompliance with applicable laws and regulations.
9. Renesas Electronics products and technologies shall not be used for or incorporated into any products or systems whose manufacture, use, or sale is prohibited under any applicable domestic or foreign laws or regulations. You shall comply with any applicable export control laws and regulations promulgated and administered by the governments of any countries asserting jurisdiction over the parties or transactions.
10. It is the responsibility of the buyer or distributor of Renesas Electronics products, or any other party who distributes, disposes of, or otherwise sells or transfers the product to a third party, to notify such third party in advance of the contents and conditions set forth in this document.
11. This document shall not be reprinted, reproduced or duplicated in any form, in whole or in part, without prior written consent of Renesas Electronics.
12. Please contact a Renesas Electronics sales office if you have any questions regarding the information contained in this document or Renesas Electronics products.
(Note 1) "Renesas Electronics" as used in this document means Renesas Electronics Corporation and also includes its directly or indirectly controlled subsidiaries.
(Note 2) "Renesas Electronics product(s)" means any product developed or manufactured by or for Renesas Electronics.

(Rev.4.0-1 November 2017)



SALES OFFICES

Renesas Electronics Corporation

<http://www.renesas.com>

Refer to "<http://www.renesas.com/>" for the latest and detailed information.

Renesas Electronics America Inc.
1001 Murphy Ranch Road, Milpitas, CA 95035, U.S.A.
Tel: +1-408-432-8888, Fax: +1-408-434-5351

Renesas Electronics Canada Limited
9251 Yonge Street, Suite 8309 Richmond Hill, Ontario Canada L4C 9T3
Tel: +1-905-237-2004

Renesas Electronics Europe Limited
Dukes Meadow, Millboard Road, Bourne End, Buckinghamshire, SL8 5FH, U.K
Tel: +44-1628-651-700, Fax: +44-1628-651-804

Renesas Electronics Europe GmbH
Arcadiastrasse 10, 40472 Düsseldorf, Germany
Tel: +49-211-6503-0, Fax: +49-211-6503-1327

Renesas Electronics (China) Co., Ltd.
Room 1709 Quantum Plaza, No.27 ZhichunLu, Haidian District, Beijing, 100191 P. R. China
Tel: +86-10-8235-1155, Fax: +86-10-8235-7679

Renesas Electronics (Shanghai) Co., Ltd.
Unit 301, Tower A, Central Towers, 555 Langao Road, Putuo District, Shanghai, 200333 P. R. China
Tel: +86-21-2226-0888, Fax: +86-21-2226-0999

Renesas Electronics Hong Kong Limited
Unit 1601-1611, 16/F., Tower 2, Grand Century Place, 193 Prince Edward Road West, Mongkok, Kowloon, Hong Kong
Tel: +852-2265-6688, Fax: +852-2886-9022

Renesas Electronics Taiwan Co., Ltd.
13F, No. 363, Fu Shing North Road, Taipei 10543, Taiwan
Tel: +886-2-8175-9600, Fax: +886-2-8175-9670

Renesas Electronics Singapore Pte. Ltd.
80 Bendemeer Road, Unit #06-02 Hyflux Innovation Centre, Singapore 339949
Tel: +65-6213-0200, Fax: +65-6213-0300

Renesas Electronics Malaysia Sdn.Bhd.
Unit 1207, Block B, Menara Amcorp, Amcorp Trade Centre, No. 18, Jln Persiaran Barat, 46050 Petaling Jaya, Selangor Darul Ehsan, Malaysia
Tel: +60-3-7955-9390, Fax: +60-3-7955-9510

Renesas Electronics India Pvt. Ltd.
No.777C, 100 Feet Road, HAL 2nd Stage, Indiranagar, Bangalore 560 038, India
Tel: +91-80-67208700, Fax: +91-80-67208777

Renesas Electronics Korea Co., Ltd.
17F, KAMCO Yangjae Tower, 262, Gangnam-daero, Gangnam-gu, Seoul, 06265 Korea
Tel: +82-2-558-3737, Fax: +82-2-558-5338