

ISL8016CIR1EVAL1Z

6A Low Quiescent Current High Efficiency Synchronous Buck Regulator

AN1630
Rev 1.00
May 17, 2011

Description

The ISL8016CIR1EVAL1Z kit is intended for use by individuals with requirements for Point-of-Load applications sourcing from 2.7V to 5.8V. The ISL8016CIR1EVAL1Z simple smallest factor evaluation board is used for a quick and easy demonstration of the performance of the ISL8016 low quiescent high efficiency synchronous buck regulator.

The ISL8016 is offered in a 3mmx4mm 20 Ld QFN package with 1mm maximum height. The complete converter occupies can be as small as 0.15in² area.

Key Features

- High Efficiency Synchronous Buck Regulator with up to 97% Efficiency
- 0.8% Reference Accuracy Over-Temperature/Load/Line
- Fixed Output Voltage Option
- ±10% Output Voltage Margining
- Adjustable Current Limit
- Current Sharing Capable
- Start-up with Pre-Biased Output
- Internal Soft-Start - 1ms or Adjustable
- Soft-Stop Output Discharge During Disabled
- Adjustable Frequency from 500kHz to 4MHz - Default at 1MHz
- External Synchronization up to 4MHz - Master to Slave Phase Shifting Capability

Recommended Equipment

The following materials are recommended to perform testing:

- 0V to 10V Power Supply with at least 10A source current capability or 5V battery
- Electronic Loads capable of sinking current up to 7A
- Digital Multimeters (DMMs)
- 100MHz quad-trace oscilloscope
- Signal generator

Quick Setup Guide

1. Ensure that the circuit is correctly connected to the supply and loads prior to applying any power.
2. Connect the bias supply to VIN, the plus terminal to VIN, J1, and the negative return to PGND, J2.
3. Connect the output load to VOUT, the plus terminal to VOUT1, J3 and the negative return to PGND, J4.
4. Verify that the position is PWM for S1.
5. Verify the position is OPEN for S2 and S3.
6. Verify that the position is ON for S4 and S5.
7. Turn on the power supply.
8. Verify the output voltage is 1.8V for VOUT1.

Evaluating the Other Output Voltage

The ISL8016CIR1EVAL1Z kit output is preset to 1.8V for VOUT1, however, output voltages can be adjusted from 0.6V to 5V. The output voltage programming resistor, R1, will depend on the desired output voltage of the regulator. The value for the feedback resistor is typically between 0Ω and 200kΩ, as shown in Equation 1.

$$R2 = R1 \left(\frac{VFB}{VO - VFB} \right) \quad (\text{EQ. 1})$$

If the output voltage desired is 0.6V, then R2 is left unpopulated and R1 is shorted. For faster response performance, add 10pF to 47pF in parallel to R1. Check bode plot to insure optimum performance.

Frequency Control

ISL8016 has an FS pin that controls the frequency of operation. Programmable frequency allows for optimization between efficiency and external component size. Default switching frequency is 1MHz when FS is tied to VIN (R6 = 0 and R5 is open). By connecting R5 to GND, the switching frequency could be changed from 500kHz (R5 = 390k) to 4MHz (R5 = 40k) according to Equation 2:

$$R_T[\text{k}\Omega] = \frac{200 \cdot 10^3}{f_{\text{OSC}}[\text{kHz}]} - 10 \quad (\text{EQ. 2})$$

When using R5 to adjust the operational frequency, this also sets external compensation mode. Please refer to the ISL8016 datasheet ([FN7616](#)) for more details.

Soft-Start Control

Short CSS1 to SGND for internal soft-start (approximately 1ms). Populate CSS1 to adjust the soft-start time. This capacitor, along with an internal 1.6mA current source, sets the soft-start interval of the converter, t_{SS} .

$$CSS1[\mu F] = 3.33 \cdot t_{SS}[s] \quad (EQ. 3)$$

CSS must be less than 33nF to insure proper soft-start reset after fault condition.

Synchronization Control

The ISL8016 can be synchronized from 700kHz to 4MHz by an external signal applied to the SYNCIN pin. The rising edge on the SYNCIN triggers the rising edge of the PHASE pulse. Make sure that the minimum on-time of the PHASE node is greater than 140ns.

SYNCOUT is a 250 μ A current pulse signal output triggered by the rising edge of the clock or the SYNCIN signal (whichever is greater in frequency) to drive the other ISL8016 and avoid the system's beat frequencies effects. To implement time shifting between the master circuit to the slave, it is recommended to add a capacitor, C13 as shown in the schematic. The time delay from SYNCOUT_Master to SYNCIN_Slave is calculated in pF using the following:

$$C_6[pF] = 0.357 \cdot t[ns] \quad (EQ. 4)$$

Where, t is the desired time shift between the master and the slave circuits in ns. Care must be taken to include PCB parasitic capacitance of ~3pF to 10pF.

The maximum should be limited to $1/F_s$ -100ns to insure that SYNCOUT has enough time to discharge before the next cycle starts.

Switiches Control

The ISL8016 evaluation board contains S1 thru S5 for various controls of the ISL8016 circuitries. Table 1 details this function.

TABLE 1. SWITCH SETTINGS

S1	MODE	FUNCTION
1	PWM	Fixed PWM frequency at light load
3	PFM	Force continuous mode
S2	ISET	PROGRAM OUTUT CURRENT
1	LOW	SET OUTPUT LOAD TO 2A.
-	OPEN	SET OUTPUT LOAD TO 6A.
3	HIGH	SET OUTPUT LOAD TO 4A.
S3	VSET	SET OUTPUT MARGIN
1	LOW	SET OUTPUT VOLTAGE -10%.
-	OPEN	NO OUTPUT VOLTAGE MARGIN
3	HIGH	SET OUTPUT VOLTAGE +10%.
S4	ENABLE	FUNCTION
1	OFF	DISABLE VOUT1
3	PFM	ENABLE VOUT1
S5	ENABLE	FUNCTION
1	OFF	DISABLE VOUT2
3	PFM	ENABLE VOUT2

ISL8016CIR1EVAL1Z Schematic

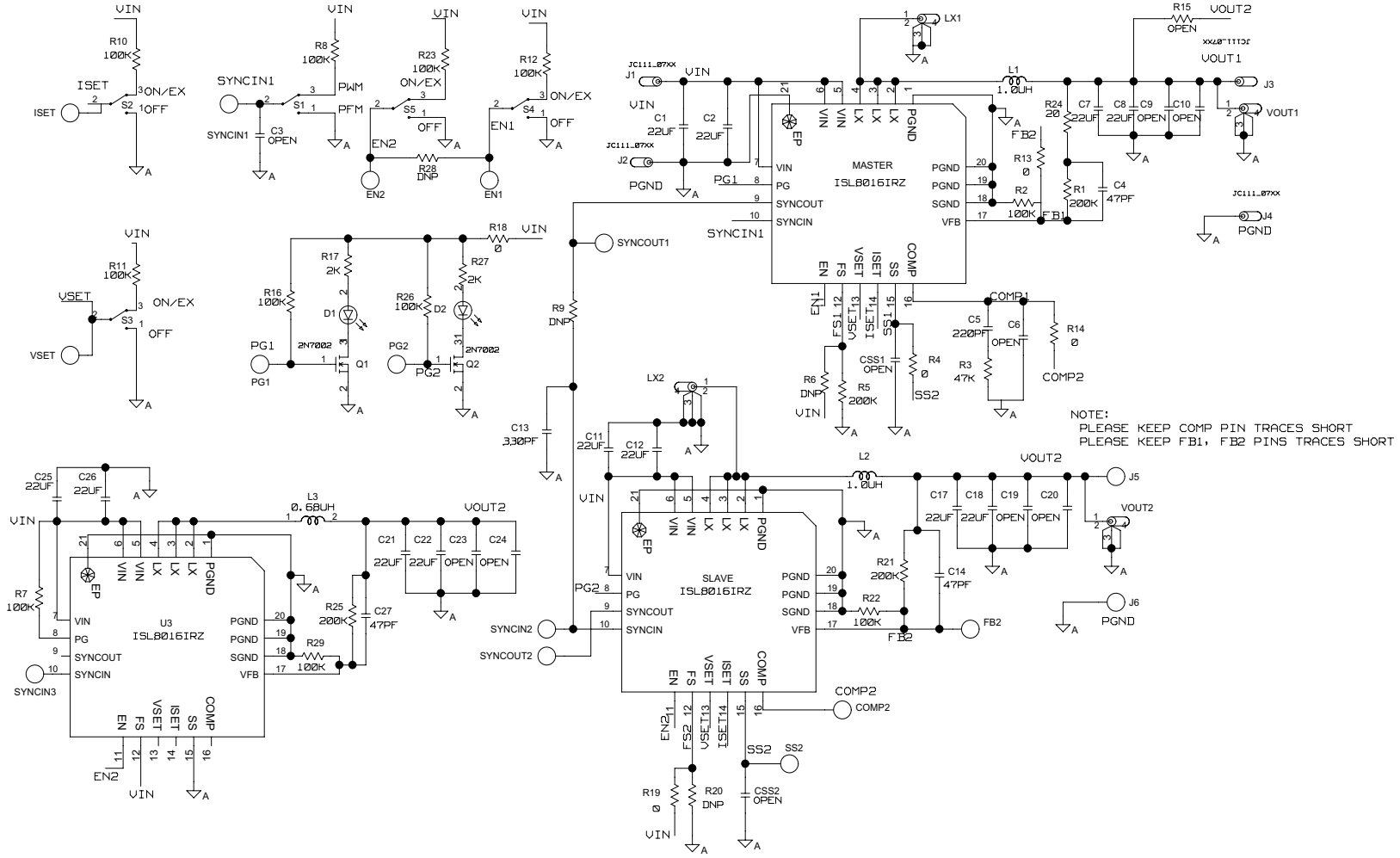

TABLE 2. BILL OF MATERIALS

PART NUMBER	QTY	UNITS	REFERENCE DESIGNATOR	DESCRIPTION	MANUFACTURER	MANUFACTURER PART #
ISL8016CIR1EVAL1ZREVAPCB	1	ea	SEE LABEL-RENAME BOARD	PWB-PCB, ISL8016CIR1EVAL1Z, REVA, ROHS	TBD	ISL8016CIR1EVAL1ZREVAPCB
H1045-00150-50V5-T	1	ea	C4	CAP, SMD, 0603, 15pF, 50V, 5%, NPO, ROHS	MURATA	GRM39COG150J050AD
H1045-00221-50V5-T	1	ea	C5	CAP, SMD, 0603, 220pF, 50V, 5%, COG, ROHS	VENKEL	C0603COG500-221JNE
H1045-00333-50V5-T	1	ea	CSS1	CAP, SMD, 0603, 33000pF, 25V, 5%, X7R, ROHS	AVX	06035C333JAT2A
H1045-DNP	0	ea	C3, C6, CSS2	CAP, SMD, 0603, DNP-PLACE HOLDER, ROHS	MURATA	GRM36COG680J050AQ
H1065-00226-6R3V20-T	5	ea	C1, C2, C7, C8, C10	CAP, SMD, 1206, 22µF, 6.3V, 20%, X5R, ROHS		
H1065-00476-6R3V20-T	1	ea	C9	CAP, SMD, 1206, 47µF, 6.3V, 20%, X5R, ROHS	MURATA	GRM31CR60J476ME19L
H1065-DNP	0	ea	C19, C20, C23, C24	CAP, SMD, 1206, DNP-PLACE HOLDER, ROHS		
IHLP-5050CE-01-1R0M	1	ea	L1	COIL-PWR INDUCTOR, SMD, 13mm, 1.0µH, 20%, 24A, ROHS	VISHAY	IHLP-5050CE-01-1R0M
111-0702-001	2	ea	J1, J3	CONN-GEN, BIND.POST, INSUL-RED, THMBNUT-GND	JOHNSON COMPONENTS	111-0702-001
111-0703-001	2	ea	J2, J4	CONN-GEN, BIND.POST, INSUL-BLK, THMBNUT-GND	JOHNSON COMPONENTS	111-0703-001
131-4353-00	2	ea	LX1, VOUT1	CONN-SCOPE PROBE TEST PT, COMPACT, PCB MNT, ROHS	TEKTRONIX	131-4353-00
1514-2	2	ea	J5, J6	CONN-TURRET, TERMINAL POST, TH, ROHS	KEYSTONE	1514-2
5000	14	ea	EN1, EN2, FB2, PG1, PG2, SS2, ISET, VSET, COMP2, SYNCIN1-SYNCIN3, SYNCOUT1, SYNCOUT2	CONN-MINI TEST PT, VERTICAL, RED, ROHS	KEYSTONE	5000
LTST-C170CKT	2	ea	D1, D2	LED-GaAs RED, SMD, 2X1.25mm, 100mW, 40mA, 10mcd, ROHS	LITEON/VISHAY	LTST-C170CKT
B340B-13-F-T	2	ea	D1, D2	DIODE-SCHOTTKY, SMD, SMB, 2P, 40V, 3A, ROHS	DIODES INC.	B340B-13-F
ISL8016IRZ	1	ea	MASTER	IC-ADJ. 6A BUCK REGULATOR, 20P, QFN, 3X4, ROHS	INTERSIL	ISL8016IRZ
2N7002-7-F-T	2	ea	Q1, Q2	TRANSISTOR, N-CHANNEL, 3 LD, SOT23, 60V, 115mA, ROHS	DIODES, INC.	2N7002-7-F
H2505-DNP	0	ea	R6, R9, R20, R28	RESISTOR, SMD, 0603, 0.1%, MF, DNP-PLACE HOLDER		
H2510-DNP	0	ea	R4, R7, R13, R14, R19, R21, R22, R25, R29	RES, SMD, 0402, DNP, DNP, DNP, TF, ROHS		

TABLE 2. BILL OF MATERIALS (Continued)

PART NUMBER	QTY	UNITS	REFERENCE DESIGNATOR	DESCRIPTION	MANUFACTURER	MANUFACTURER PART #
H2511-00200-1/10W1-T	1	ea	R24	RES,SMD,0603,20ohm,1/10W,1%,TF,ROHS	PANASONIC	ERJ-3EKF20R0V
H2511-00R00-1/10W-T	1	ea	R18	RES,SMD,0603,0Ω,1/10W,TF,ROHS	VENKEL	CR0603-10W-000T
H2511-01003-1/10W1-T	9	ea	R2, R3, R8, R10-R12, R16, R23, R26	RES,SMD,0603,100k,1/10W,1%,TF,ROHS	VENKEL	ERJ-3EKF1003V
					ROHM	CR0603-10W-1003FT
					YAGEO	MCR03EZPFX1003
					VISHAY/DALE	ERJ-3EKF1004V
H2511-02003-1/10W1-T	2	ea	R1, R5	RES,SMD,0603,200k,1/10W,1%,TF,ROHS	PANASONIC	ERJ-3EKF2003V
					VENKEL	CR0603-10W-2003FT
					ROHM	MCR03EZPFX2003
					KOA	RK73H1JTTD2003F
					VISHAY/DALE	CRCW06031M00FKEA
H2511-DNP	0	ea	R17, R27	RES,SMD,0603,DNP-PLACE HOLDER, ROHS		
H2514-DNP	0	ea	R15	RES,SMD,1210,DNP,DNP,DNP,TF,ROHS		
GT11MSCBE-T	3	ea	S1, S4, S5	SWITCH-TOGGLE,SMD,6PIN,SPDT,2POS,ON-ON,ROHS	ITT INDUSTRIES/C&K DIVISION	GT11MSCBE
GT13MSCBE	2	ea	S2, S3	SWITCH-TOGGLE,SMD,6PIN,SPDT,3POS,ON-OFF-ON,ROHS	ITT INDUSTRIES/C&K DIVISION	GT13MSCBE
DNP	0	ea	C11-C14, C17, C18, C21, C22, C25-C27	DO NOT POPULATE OR PURCHASE		
DNP	0	ea	L2, L3, LX2, VOUT2, U3, SLAVE	DO NOT POPULATE OR PURCHASE		

ISL8016CIR1EVAL1Z Board Layout

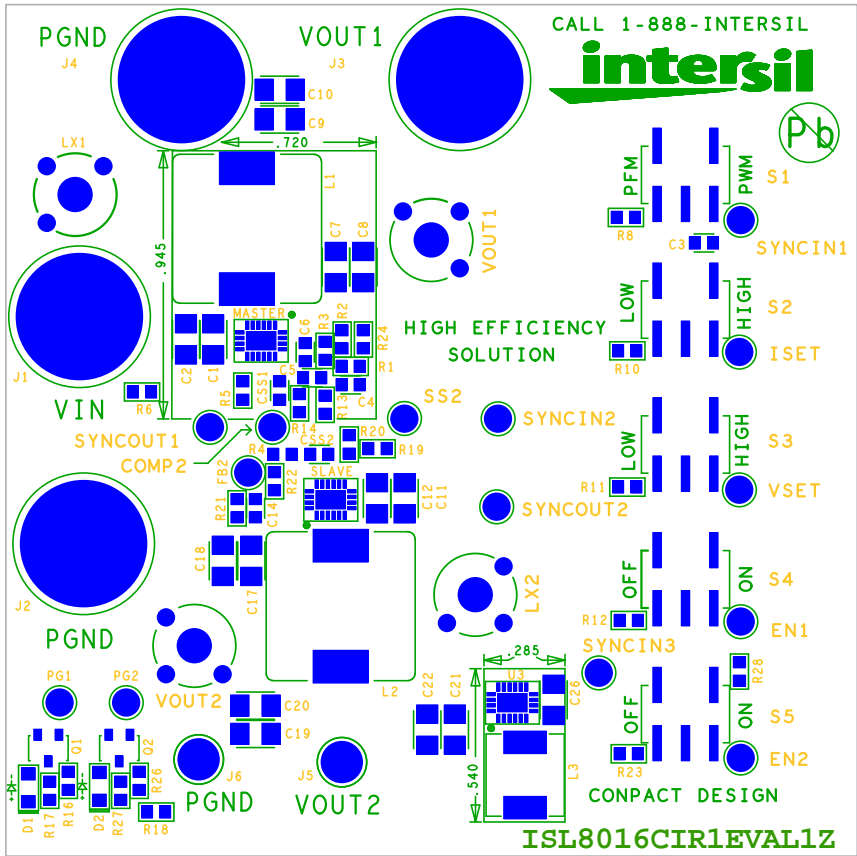

FIGURE 1. TOP LAYER COMPONENTS

ISL8016CIR1EVAL1Z Board Layout (Continued)

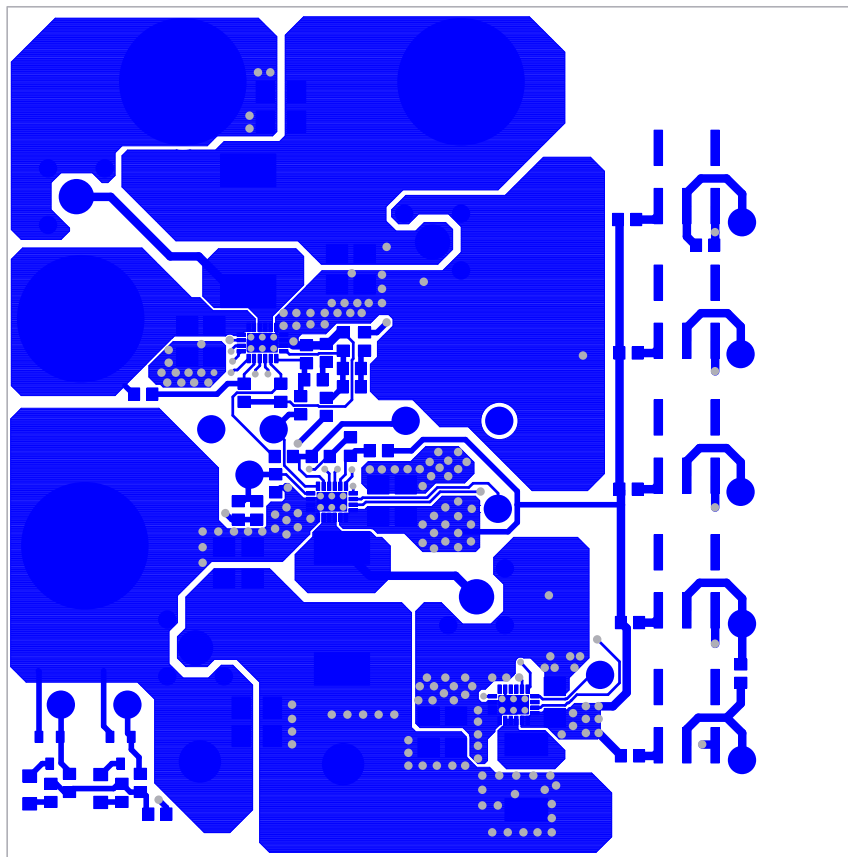

FIGURE 2. TOP LAYER ETCH

ISL8016CIR1EVAL1Z Board Layout (Continued)

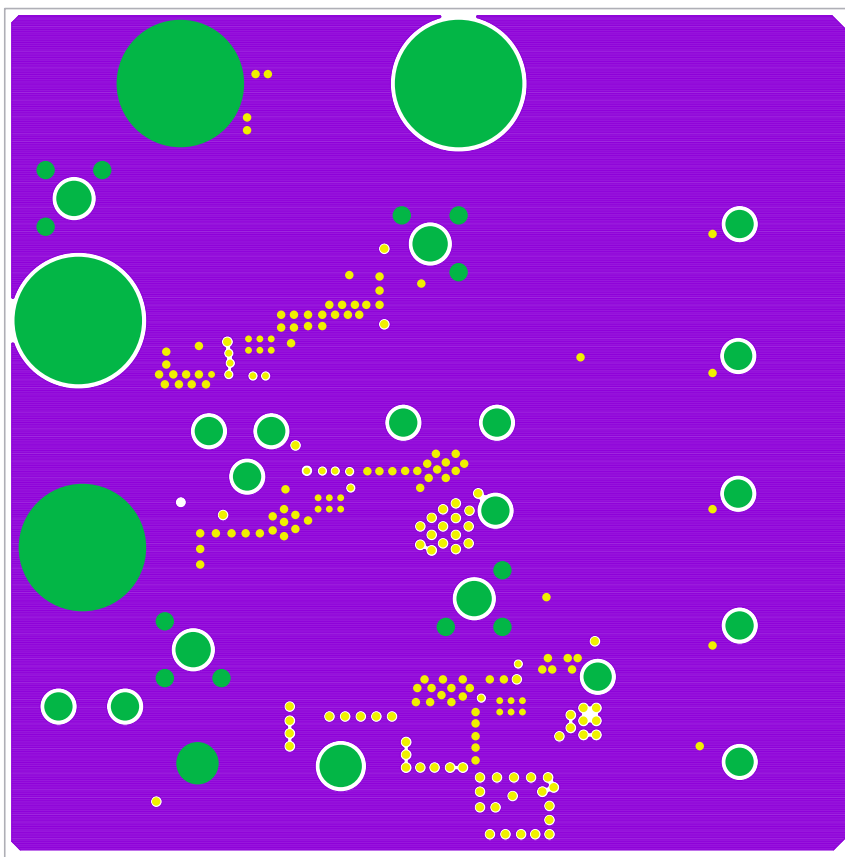

FIGURE 3. SECOND LAYER ETCH

ISL8016CIR1EVAL1Z Board Layout (Continued)

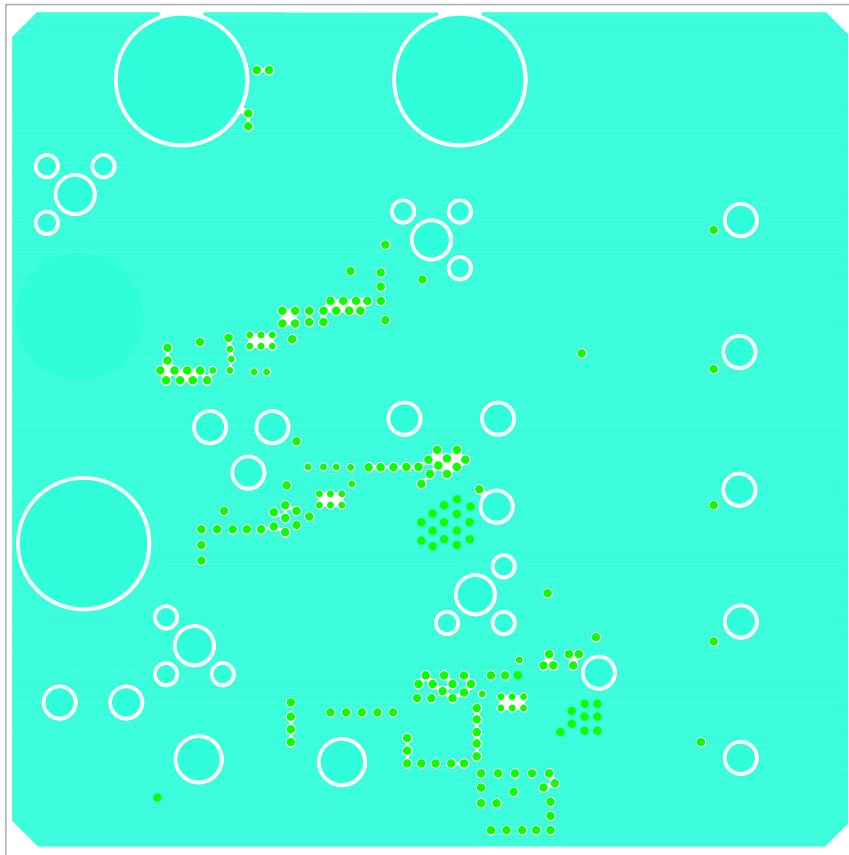

FIGURE 4. THIRD LAYER ETCH

ISL8016CIR1EVAL1Z Board Layout (Continued)

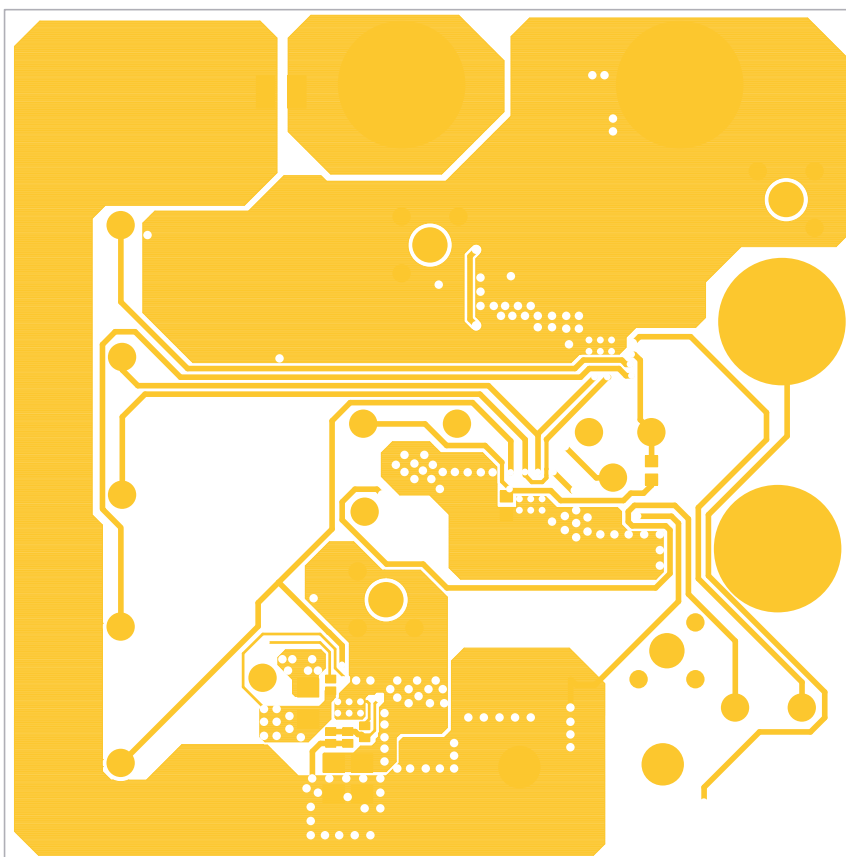

FIGURE 5. BOTTOM LAYER ETCH

ISL8016CIR1EVAL1Z Board Layout (Continued)

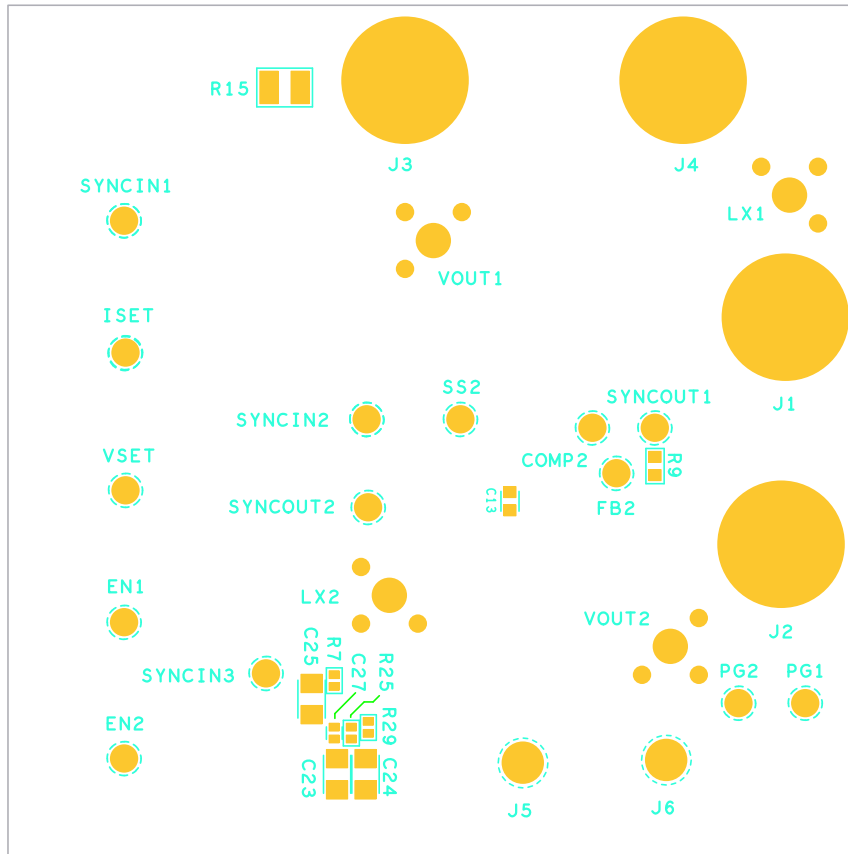

FIGURE 6. BOTTOM LAYER COMPONENTS

Notice

1. Descriptions of circuits, software and other related information in this document are provided only to illustrate the operation of semiconductor products and application examples. You are fully responsible for the incorporation or any other use of the circuits, software, and information in the design of your product or system. Renesas Electronics disclaims any and all liability for any losses and damages incurred by you or third parties arising from the use of these circuits, software, or information.
2. Renesas Electronics hereby expressly disclaims any warranties against and liability for infringement or any other claims involving patents, copyrights, or other intellectual property rights of third parties, by or arising from the use of Renesas Electronics products or technical information described in this document, including but not limited to, the product data, drawings, charts, programs, algorithms, and application examples.
3. No license, express, implied or otherwise, is granted hereby under any patents, copyrights or other intellectual property rights of Renesas Electronics or others.
4. You shall not alter, modify, copy, or reverse engineer any Renesas Electronics product, whether in whole or in part. Renesas Electronics disclaims any and all liability for any losses or damages incurred by you or third parties arising from such alteration, modification, copying or reverse engineering.
5. Renesas Electronics products are classified according to the following two quality grades: "Standard" and "High Quality". The intended applications for each Renesas Electronics product depends on the product's quality grade, as indicated below.
"Standard": Computers; office equipment; communications equipment; test and measurement equipment; audio and visual equipment; home electronic appliances; machine tools; personal electronic equipment; industrial robots; etc.
"High Quality": Transportation equipment (automobiles, trains, ships, etc.); traffic control (traffic lights); large-scale communication equipment; key financial terminal systems; safety control equipment; etc.
Unless expressly designated as a high reliability product or a product for harsh environments in a Renesas Electronics data sheet or other Renesas Electronics document, Renesas Electronics products are not intended or authorized for use in products or systems that may pose a direct threat to human life or bodily injury (artificial life support devices or systems; surgical implantations; etc.), or may cause serious property damage (space system; undersea repeaters; nuclear power control systems; aircraft control systems; key plant systems; military equipment; etc.). Renesas Electronics disclaims any and all liability for any damages or losses incurred by you or any third parties arising from the use of any Renesas Electronics product that is inconsistent with any Renesas Electronics data sheet, user's manual or other Renesas Electronics document.
6. When using Renesas Electronics products, refer to the latest product information (data sheets, user's manuals, application notes, "General Notes for Handling and Using Semiconductor Devices" in the reliability handbook, etc.), and ensure that usage conditions are within the ranges specified by Renesas Electronics with respect to maximum ratings, operating power supply voltage range, heat dissipation characteristics, installation, etc. Renesas Electronics disclaims any and all liability for any malfunctions, failure or accident arising out of the use of Renesas Electronics products outside of such specified ranges.
7. Although Renesas Electronics endeavors to improve the quality and reliability of Renesas Electronics products, semiconductor products have specific characteristics, such as the occurrence of failure at a certain rate and malfunctions under certain use conditions. Unless designated as a high reliability product or a product for harsh environments in a Renesas Electronics data sheet or other Renesas Electronics document, Renesas Electronics products are not subject to radiation resistance design. You are responsible for implementing safety measures to guard against the possibility of bodily injury, injury or damage caused by fire, and/or danger to the public in the event of a failure or malfunction of Renesas Electronics products, such as safety design for hardware and software, including but not limited to redundancy, fire control and malfunction prevention, appropriate treatment for aging degradation or any other appropriate measures. Because the evaluation of microcomputer software alone is very difficult and impractical, you are responsible for evaluating the safety of the final products or systems manufactured by you.
8. Please contact a Renesas Electronics sales office for details as to environmental matters such as the environmental compatibility of each Renesas Electronics product. You are responsible for carefully and sufficiently investigating applicable laws and regulations that regulate the inclusion or use of controlled substances, including without limitation, the EU RoHS Directive, and using Renesas Electronics products in compliance with all these applicable laws and regulations. Renesas Electronics disclaims any and all liability for damages or losses occurring as a result of your noncompliance with applicable laws and regulations.
9. Renesas Electronics products and technologies shall not be used for or incorporated into any products or systems whose manufacture, use, or sale is prohibited under any applicable domestic or foreign laws or regulations. You shall comply with any applicable export control laws and regulations promulgated and administered by the governments of any countries asserting jurisdiction over the parties or transactions.
10. It is the responsibility of the buyer or distributor of Renesas Electronics products, or any other party who distributes, disposes of, or otherwise sells or transfers the product to a third party, to notify such third party in advance of the contents and conditions set forth in this document.
11. This document shall not be reprinted, reproduced or duplicated in any form, in whole or in part, without prior written consent of Renesas Electronics.
12. Please contact a Renesas Electronics sales office if you have any questions regarding the information contained in this document or Renesas Electronics products.
(Note 1) "Renesas Electronics" as used in this document means Renesas Electronics Corporation and also includes its directly or indirectly controlled subsidiaries.
(Note 2) "Renesas Electronics product(s)" means any product developed or manufactured by or for Renesas Electronics.

(Rev.4.0-1 November 2017)



SALES OFFICES

Renesas Electronics Corporation

<http://www.renesas.com>

Refer to "<http://www.renesas.com/>" for the latest and detailed information.

Renesas Electronics America Inc.
1001 Murphy Ranch Road, Milpitas, CA 95035, U.S.A.
Tel: +1-408-432-8888, Fax: +1-408-434-5351

Renesas Electronics Canada Limited
9251 Yonge Street, Suite 8309 Richmond Hill, Ontario Canada L4C 9T3
Tel: +1-905-237-2004

Renesas Electronics Europe Limited
Dukes Meadow, Millboard Road, Bourne End, Buckinghamshire, SL8 5FH, U.K
Tel: +44-1628-651-700, Fax: +44-1628-651-804

Renesas Electronics Europe GmbH
Arcadiastrasse 10, 40472 Düsseldorf, Germany
Tel: +49-211-6503-0, Fax: +49-211-6503-1327

Renesas Electronics (China) Co., Ltd.
Room 1709 Quantum Plaza, No.27 ZhichunLu, Haidian District, Beijing, 100191 P. R. China
Tel: +86-10-8235-1155, Fax: +86-10-8235-7679

Renesas Electronics (Shanghai) Co., Ltd.
Unit 301, Tower A, Central Towers, 555 Langao Road, Putuo District, Shanghai, 200333 P. R. China
Tel: +86-21-2226-0888, Fax: +86-21-2226-0999

Renesas Electronics Hong Kong Limited
Unit 1601-1611, 16/F., Tower 2, Grand Century Place, 193 Prince Edward Road West, Mongkok, Kowloon, Hong Kong
Tel: +852-2265-6688, Fax: +852-2886-9022

Renesas Electronics Taiwan Co., Ltd.
13F, No. 363, Fu Shing North Road, Taipei 10543, Taiwan
Tel: +886-2-8175-9600, Fax: +886-2-8175-9670

Renesas Electronics Singapore Pte. Ltd.
80 Bendemeer Road, Unit #06-02 Hyflux Innovation Centre, Singapore 339949
Tel: +65-6213-0200, Fax: +65-6213-0300

Renesas Electronics Malaysia Sdn.Bhd.
Unit 1207, Block B, Menara Amcorp, Amcorp Trade Centre, No. 18, Jln Persiaran Barat, 46050 Petaling Jaya, Selangor Darul Ehsan, Malaysia
Tel: +60-3-7955-9390, Fax: +60-3-7955-9510

Renesas Electronics India Pvt. Ltd.
No.777C, 100 Feet Road, HAL 2nd Stage, Indiranagar, Bangalore 560 038, India
Tel: +91-80-67208700, Fax: +91-80-67208777

Renesas Electronics Korea Co., Ltd.
17F, KAMCO Yangjae Tower, 262, Gangnam-daero, Gangnam-gu, Seoul, 06265 Korea
Tel: +82-2-558-3737, Fax: +82-2-558-5338