

ISL9519CEVAL1Z

Evaluation Board Setup Procedure

AN1654  
Rev 0.00  
Aug 2, 2011

The ISL9519C is a highly integrated Narrow VDC regulator/battery charger controller for Li-ion/Li-ion polymer batteries. It has an SMBus interface and internal switching FETs that control system voltage, charge current, and input current limiting. The ISL9519CEVAL1Z evaluation board includes a USB to SMBus interface to allow users to control the ISL9519C from a personal computer.

**ISL9519CEVAL1Z vs ISL9519EVAL1Z**

The ISL9519CEVAL1Z board battery charger control IC contains the N-CH MOSFETs that drive the synchronous buck converter inductor. Functionality is otherwise the same on both boards.

**What's Inside**

The ISL9519CEVAL1Z Evaluation Board Kit contains the following materials:

- Qty (1) ISL9519CEVAL1Z Evaluation Board
- Qty (1) USB cable

**What's Needed**

The following materials are recommended to perform testing (Figure 1):

- One adjustable 25V/6A power supply
- Two adjustable electronic loads with constant current mode and constant voltage mode
- One volt meter
- One 500MHz four-channel oscilloscope with voltage and current probes
- A personal computer (PC) with ISL9519 control software and drivers, available under [Tools and Support](#) on the [ISL9519C Device Information page](#).

NOTE: The National Instruments Runtime Engine must be installed before connecting the evaluation board to your PC. The Runtime Engine contains driver files required by the New Hardware Wizard. The Runtime Engine can be downloaded from the National Instruments web site at: <http://www.ni.com/>

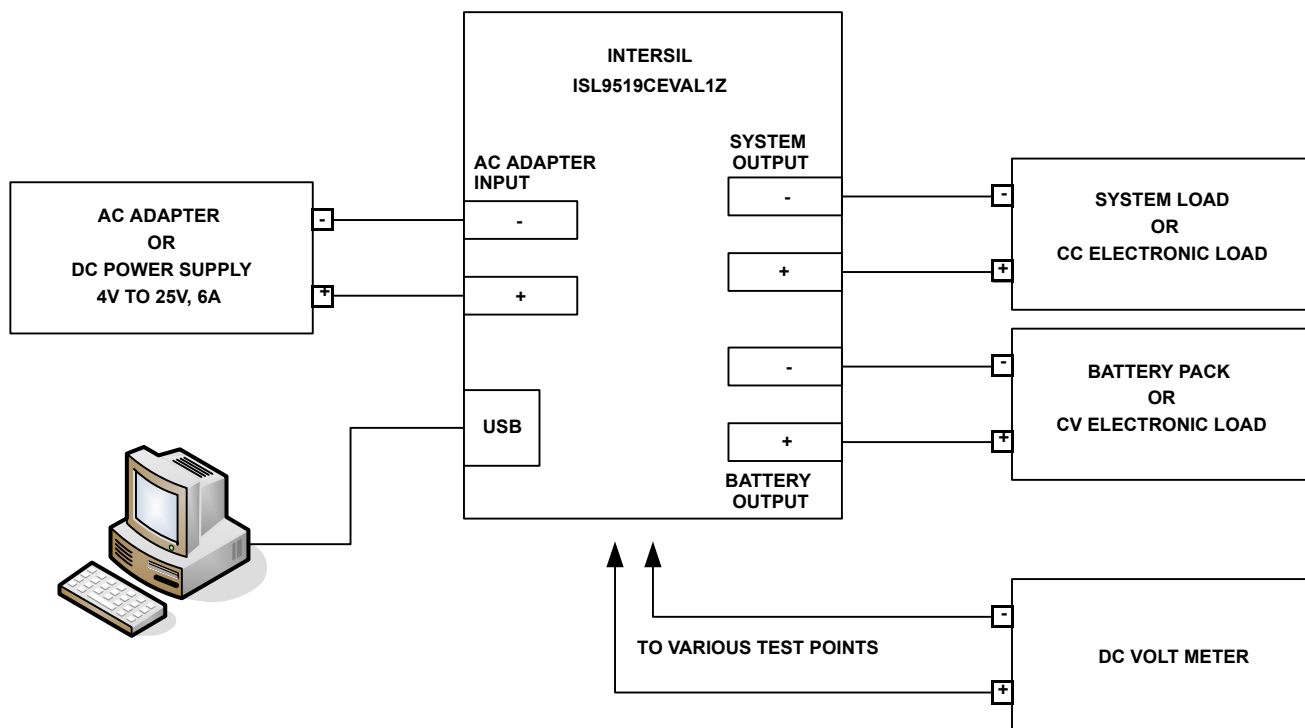

FIGURE 1. ISL9519CEVAL1Z HARDWARE CONNECTION DIAGRAM

## Install the Software

1. Download the ISL9519 CONTROL Software Installer.zip file from [Tools and Support](#) on the [ISL9519C Device Information page](#). Extract it to a folder on your PC. Navigate to the folder and double-click the **AutoRun.exe** file. The **AutoRun CD Menu** window opens (Figure 2).

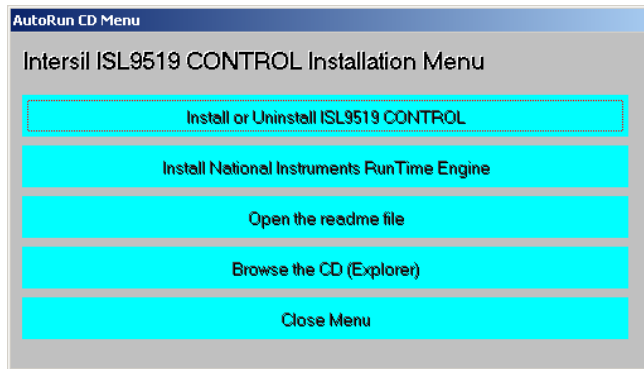

FIGURE 2. AUTORUN CD MENU

2. In the **AutoRun CD Menu** window, click **Install or Uninstall ISL9519 CONTROL** to open the **ISL9519 CONTROL Installation Wizard** (Figure 3).



FIGURE 3. ISL9519 CONTROL INSTALLATION WIZARD

3. In the **ISL9519 CONTROL Installation Wizard** window, click through the steps of the wizard to install the ISL9519 software. For most PCs, this installation also automatically downloads the National Instruments Runtime Engine installation wizard. If so, the **NI\_VISA 4.3 Runtime** installation window opens (Figure 4).
4. In the **NI\_VISA 4.3 Runtime** installation window, click through the steps and follow the instructions to install the National Instruments Runtime Engine.
5. If the National Instruments Runtime Engine does not download automatically, then in the **AutoRun CD Menu** window (Figure 2), click **Install National Instruments Run Time Engine**. After installation, click **Close Menu**.

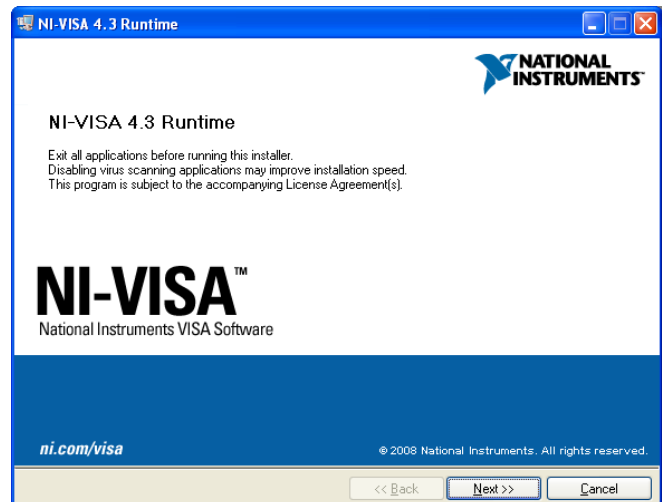

FIGURE 4. NATIONAL INSTRUMENTS RUNTIME ENGINE INSTALLATION WIZARD

## Driver Installation

After installing the National Instruments Runtime Engine, connect the ISL9519CEVAL1Z evaluation board to the USB port of your PC.

**NOTE:** The SMBus part of the ISL9519C and the USB-SMBus interface are powered by the 5V from the USB port on the PC. It is not necessary to have other power supplies connected to the evaluation board to read or write to the ISL9519C.

When Microsoft Windows detects new hardware, the **Welcome to the Found New Hardware Wizard** appears (Figure 5). Click the **Install from a list or specific location** radio button and click **Next**.

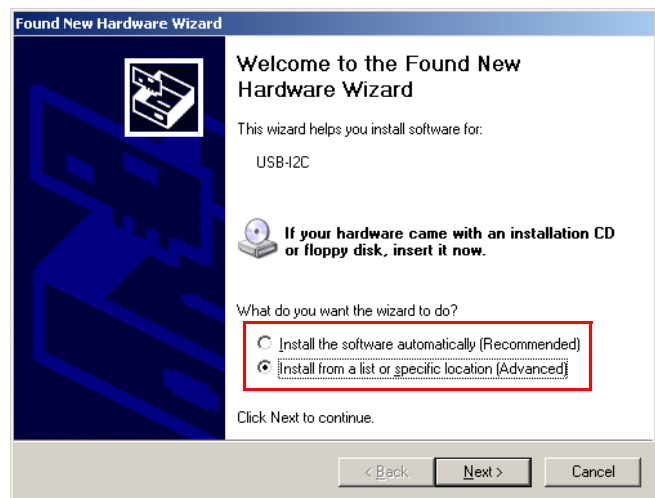

FIGURE 5. SELECT "INSTALL FROM A SPECIFIC LOCATION"

In the next window of the wizard, click the **Don't search, I will choose the driver to install** radio button and click **Next** (Figure 6).

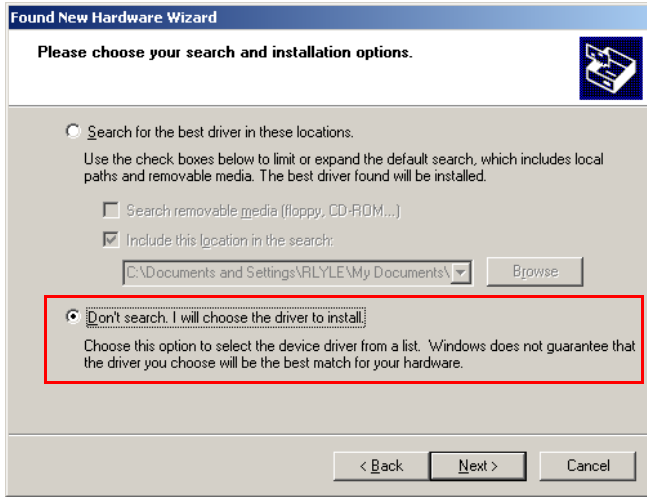

FIGURE 6. SELECT “DON'T SEARCH”

In the window that appears, select the driver, click **Have Disk**, and then click **Next** (Figure 7).

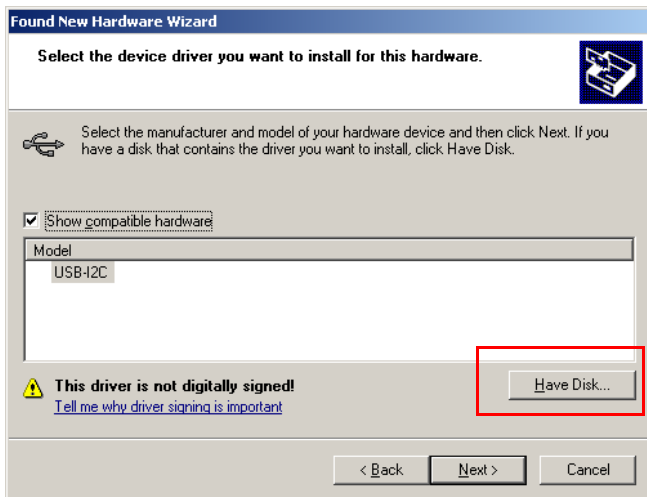

FIGURE 7. CLICK “HAVE DISK”

In the **Locate File** dialog that appears, browse to the **ISL9519 CONTROL Software Installer** folder extracted from the downloaded zip file, and select the **USB-I2C\_WDM.inf** driver information file (Figure 8). In some systems, it may be necessary to specify the driver information file (USB-I2C\_WDM.inf). Click **Open**. The wizard should indicate that files are being copied. After file transfer, the wizard should indicate that the new hardware is ready to use.

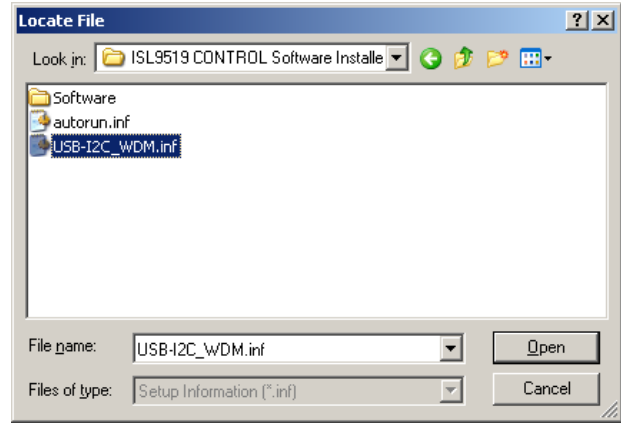

FIGURE 8. LOCATE DRIVER INFORMATION FILE

## Run the ISL9519 Application

The ISL9519 evaluation software should now appear in your computer's **Start→All Programs** list. Click the program name to run the application.

Figure 9 shows the ISL9519 user interface.

## Enable the Output

When power is applied to the ISL9519C, the Charge Current and Charge Voltage Registers are 0x0000, and the output is disabled. The output is enabled by writing valid, non-zero values to these two registers. See the [ISL9519C datasheet](#) for valid values.

The ISL9519C is also disabled if the ACIN pin is below 3.2V. The minimum input voltage can be adjusted on the evaluation board by changing R<sub>6</sub> or R<sub>7</sub> (see Figure 15).

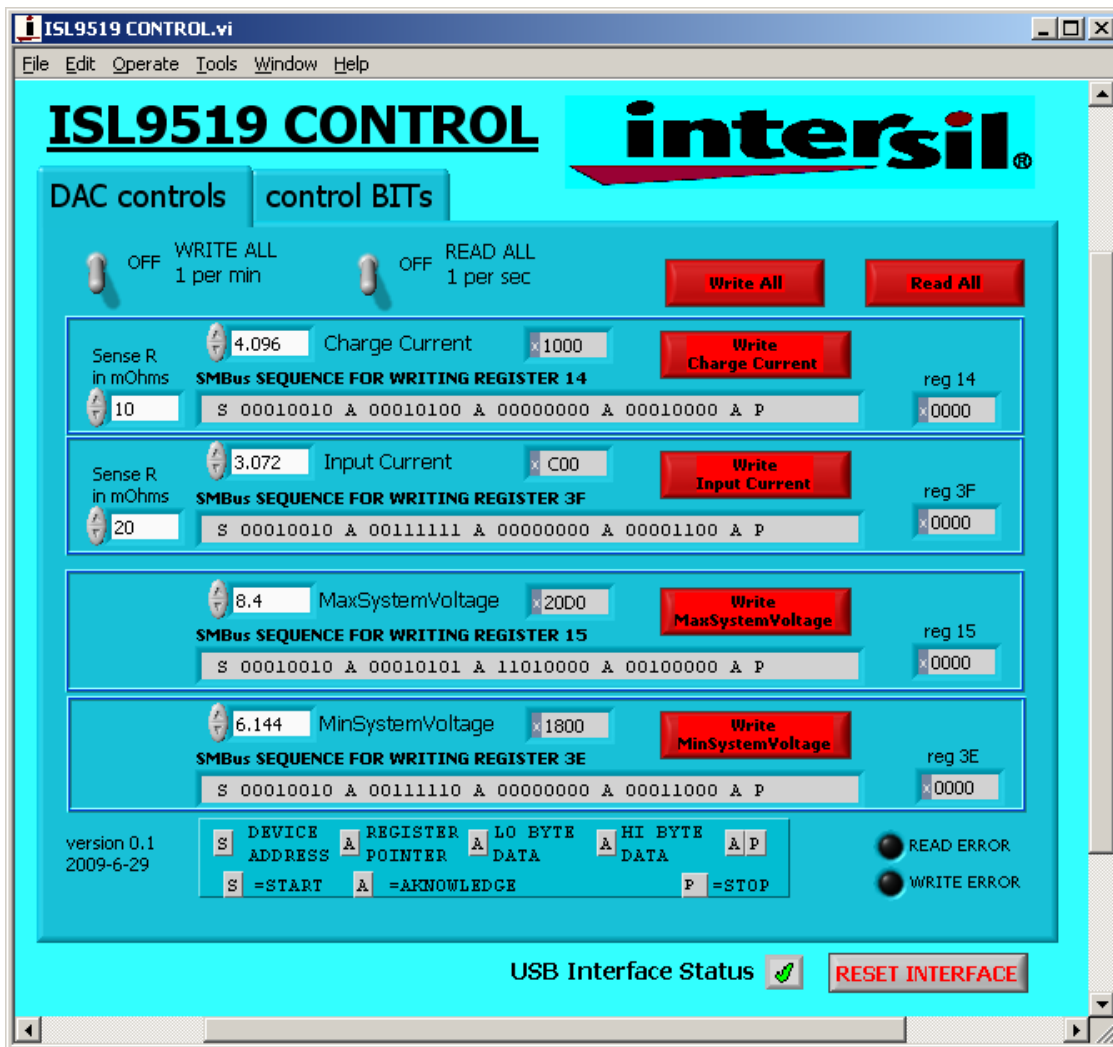

FIGURE 9. ISL9519 CONTROL SOFTWARE USER INTERFACE

### User Interface Controls and Display Information - DAC Controls Tab

#### WRITE ALL, READ ALL, RESET

Click the **Write All** button to write the indicated SMBus sequences to Registers 14, 15, 3F and 3E in the ISL9519C.



NOTE: The SMBus part of the ISL9519C and the USB interface are powered by the 5V from the USB port on the PC. It is not necessary to have other power supplies connected to the evaluation board to read or write to the ISL9519C.

Click the **Read All** button to read all six registers in the ISL9519C and display the results in the register indicator text boxes below the **Read All** button.



If the device and interface are operating normally, the **VendorID (reg FE)** and **DeviceID (reg FF)** fields display with non-zero values, as follows:

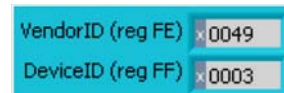

If the **VendorID (reg FE)** and **DeviceID (reg FF)** fields continue to display 0000, it indicates a communication problem.

If the Visa resource name is blank, it indicates a problem with the USB communication.

Click the **RESET INTERFACE** button in the lower right corner of the user interface window to correct the problem. If this does not work, try closing the software, removing power and USB connections from the evaluation board, and then reconnecting and restarting.

Note the register contents are updated *only* when the **Read All** button is clicked.

**CHARGE CURRENT**

The **Write Charge Current** button sends only the charge current to the ISL9519C. Other registers are unchanged,



The white text field on the left side of the **Charge Current** area accepts input in amps and converts it to a hexadecimal (hex) value to be written to the ISL9519C. This hex value is displayed in the gray read-out window on the right side.



The hex value depends on the value entered in the **Sense R in mOhms** text field on the far left of the **Charge Current** area.



The value in the white text field is forced to the nearest valid number that can be produced by the DAC in the ISL9519C. For example, if you enter **4** in the white text field and press **Enter** on your keyboard, the gray read-out field changes to **3.968**. If you enter **4.1**, the display changes to **4.096**. The value entered can be incremented and decremented with the up/down arrows to the left of the white text field.

Values entered in the **Sense R in mOhms** text input fields on the far left of the **Charge Current** and **Input Current** areas are used to calculate the hexadecimal (hex) values and the SMBus sequences for the Charge Current limit and Input Current limit values entered in the white text input fields. The evaluation board is built with 20mΩ/10mΩ sense resistors. If you change them to another value, enter the new value to get correct calculations.

After entering a number in the **Sense R in mOhms** text input field, press **Enter** or click in another area to enter the value. The resulting hex value and SMBus sequence are calculated and displayed in the gray **SMBus SEQUENCE FOR WRITING REGISTER (XX)** read-out field for the register being programmed.

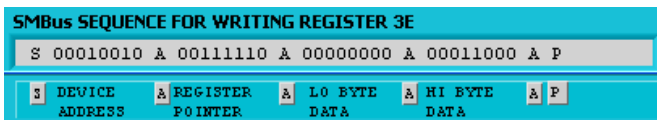

In this field, S = Start condition, A = Acknowledge, and P = Stop condition. The LO byte is sent first and then the HI byte. For example, when writing 0x41A0, 0xA0 is written first and then 0x41 is sent.

**IMPORTANT NOTE:** The SMBus commands are *not* sent until one of the WRITE buttons is clicked (i.e., **Write All** or **Write Charge Current**) (Figure 10).

**MAX AND MIN SYSTEM VOLTAGE**

**IMPORTANT NOTE:** Max System Voltage Commands that are much higher than the voltage for the number of cells selected by the CELL pin are ignored (not acknowledged). See the “Max Accepted Max System Voltage Command” section of the [ISL9519C datasheet](#) for details.

In the **MaxSystemVoltage** area of the **DAC Controls** tab, the **Write MaxSystem Voltage** button writes only the MaxSystem Voltage register. Other registers are unchanged.

The white text input field on the left side of this area accepts max system voltage values in Volts and calculates the hexadecimal value and the SMBus sequence to write to the ISL9519C. The SMBus command is sent when the **Write MaxSystemVoltage** or **Write All** button is clicked (Figures 11 and 12).

**INPUT CURRENT**

In the **Input Current** area of the **DAC Controls** tab, the **Write Input Current** button writes only the Input Current register. Other registers are unchanged. The white text input field on the left side of the area accepts input current limit values in amps and calculates the hexadecimal value and the SMBus sequence to be written to the ISL9519C. The **Sense R in mOhms** text input field on the far left of the area accepts input that is used to calculate the hexadecimal value and the SMBus sequence. The SMBus command is sent when the **Write Input Current** or **Write All** button is clicked (Figure 13).

The ISL9519C shuts down unless it receives MaxSystem Voltage or Charge Current commands every 175s. This is a safety feature that prevents overcharging of batteries if the bus master has stopped functioning. A toggle switch on the upper left of the **DAC Controls** tab can be set to tell the software to write all commands every 60 seconds.

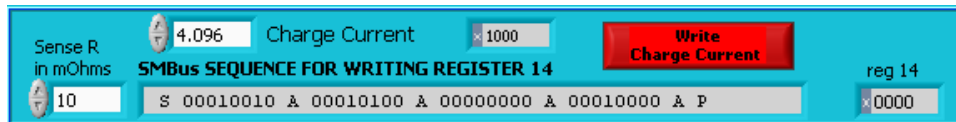
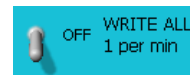

FIGURE 10. WRITE CHARGE CURRENT



FIGURE 11. WRITE MAX SYSTEM VOLTAGE

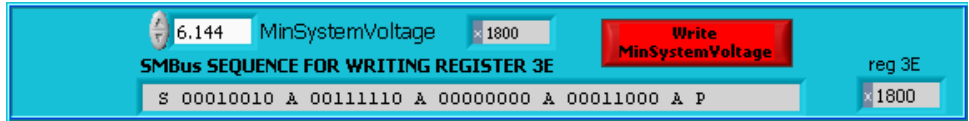

FIGURE 12. WRITE MIN SYSTEM VOLTAGE



FIGURE 13. WRITE INPUT CURRENT

### User Interface Controls and Display Information - Controls Bits Tab

The Control Register is modified in the **control BITS** tab by clicking the toggle switches to change the control bit settings (Figure 14). A selected bit is indicated by a raised green switch lever. The bit pattern that is written to Register 3D is displayed in the gray **SMBus SEQUENCE FOR WRITING REGISTER 3D** read-out field. Click the **Write CONTROL REG** button to write the indicated

pattern. Click the **READ ALL** button to display the contents of Register 3D in the gray read-out field. The functions of Register 3D are described in the [ISL9519C datasheet](#).

The **READ ERROR** or **WRITE ERROR** indicator flashes red if a read error or write error, respectively, occurs. If this happens, check the interface cabling. If problems persist, disconnect and reinsert the USB cable, and click the **RESET INTERFACE** button.



FIGURE 14. CONTROL BITS TAB FOR WRITING THE CONTROL REGISTER

## Interface Troubleshooting

When the evaluation board is connected to the PC by a USB cable and is communicating to the board through the USB interface, a green check mark appears next to **USB Interface Status** in the lower right corner of user interface window.



If there is a red X instead of the green check mark, it indicates a problem with communication between the PC and the microcontroller on the evaluation board. Check and correct the connection of the USB cable to your PC and the evaluation board,

and then click **RESET INTERFACE**. If you still get a red X, close and restart the ISL9519 control software.

If you still get a red X, with the ISL9519CEVAL1Z evaluation board still connected to your USB port, open the Windows Device Manager (Start->Control Panel->System->Hardware->Device Manager). In the list of devices that appears, you should see a device called **NI-VISA USB Device**. If it is not in the list of devices, the driver may not be correctly installed. Run the **New Hardware Wizard** as described in "Driver Installation" on page 2.

If you still get a red X, contact an Intersil Field Application Engineer for assistance.

# ISL9519CEVAL1Z Schematics

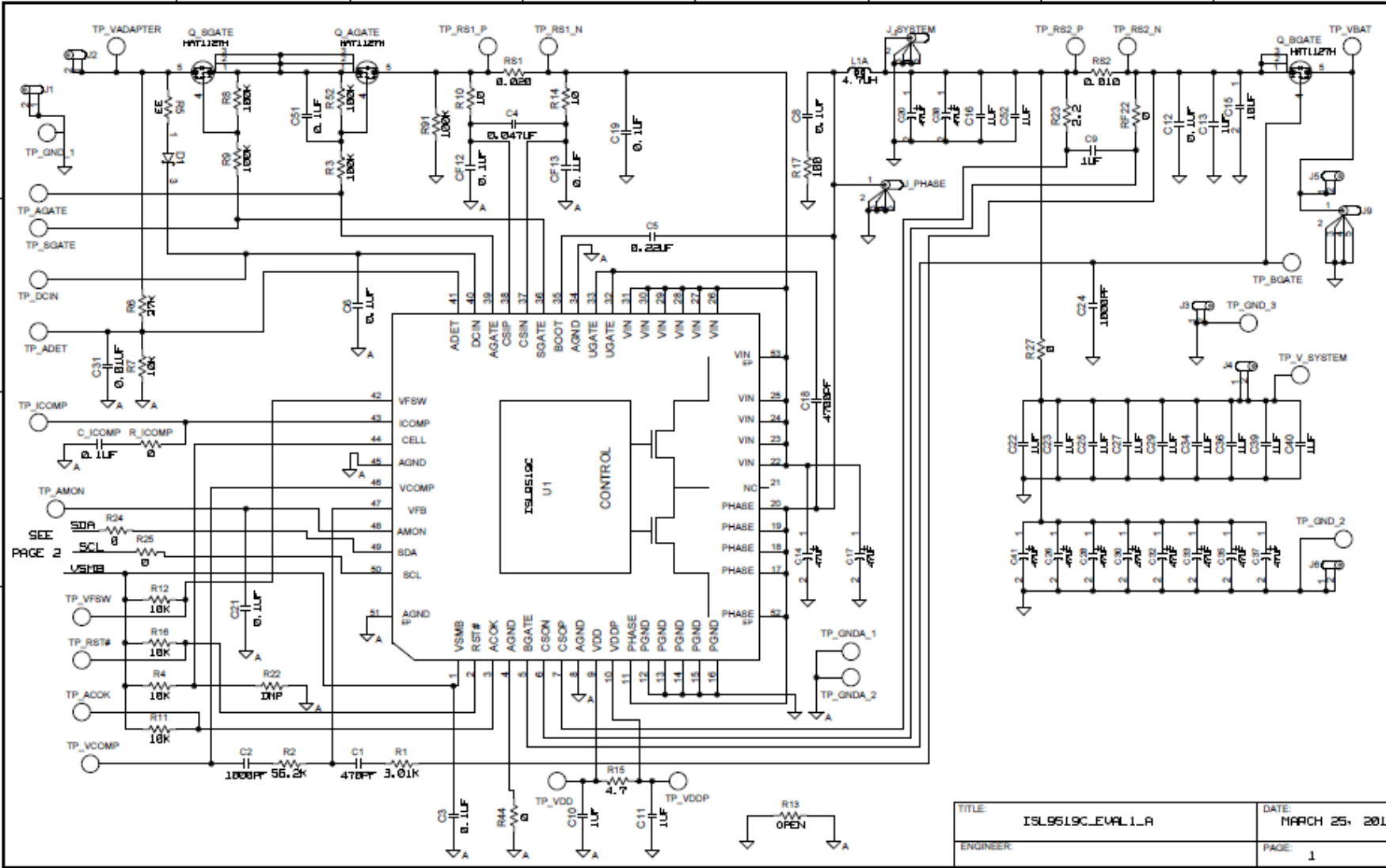

FIGURE 15. ISL9519C EVAL1Z REV A SCHEMATIC



# ISL9519CEVAL1Z Schematics (Continued)

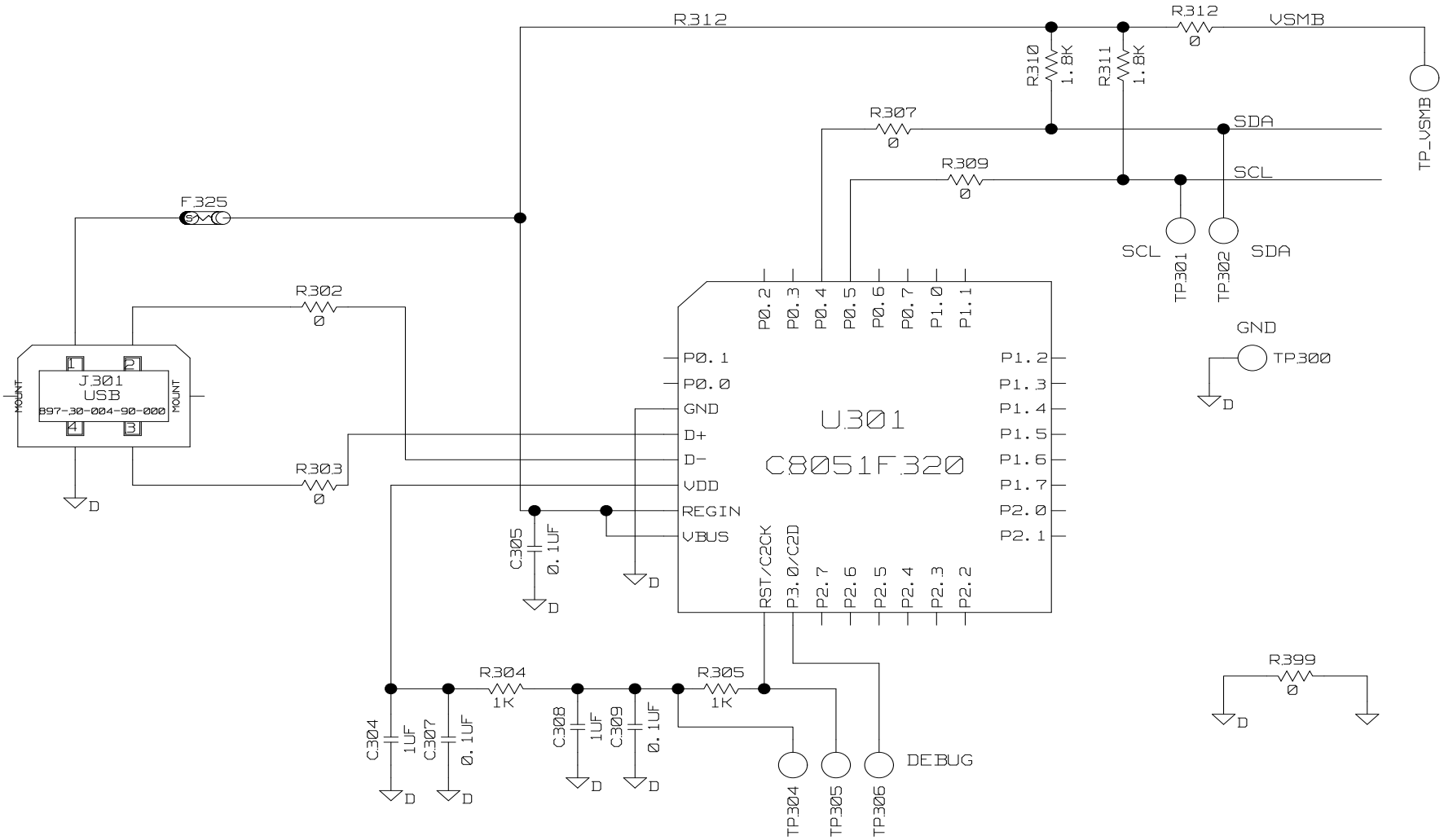

FIGURE 16. ISL9519C EVAL1Z REV A SCHEMATIC

TABLE 1. ISL9519CEVAL1Z, REV A EVALUATION BOARD BILL OF MATERIALS

NO.	REF DES	QTY	DESCRIPTION	MANUFACTURER
1	C1	1	CAP, SMD, 0603, 470pF, 50V, 5%, X7R, ROHS	GENERIC
2	C2	1	CAP, SMD, 0603, 1000pF, 50V, 5%, X7R, ROHS	GENERIC
3	C_ICOMP	1	CAP, SMD, 0603, 0.1μF, 25V, 10%, X7R, ROHS	GENERIC
4	C10, C11	2	CAP, SMD, 0603, 1.0μF, 6.3V, 10%, X7R, ROHS	GENERIC
5	C13, C16, C22, C23, C25, C27, C29, C34, C36, C39, C40, C52	12	CAP, SMD, 0805, 1.0μF, 25V, 10%, X5R, ROHS	GENERIC
6	C14, C17, C20, C26, C28, C30, C32, C33, C35, C37, C38, C41	12	CAP, SMD, 20TQC47M, 47μF, 20V, 20%, ROHS	SANYO
7	C15	1	CAP, SMD, 1206, 10μF, 25V, 20%, X5R, ROHS	GENERIC
8	C18	1	CAP, SMD, 0603, 4700pF, 50V, 10%, X7R, ROHS	GENERIC
9	C24	1	CAP, SMD, 0603, 1000pF, 50V, 5%, X7R, ROHS	GENERIC
10	C3, C6, C8, C12, C19, C21, C51, CF12, CF13, C305, C307, C309	12	CAP, SMD, 0603, 0.1μF, 25V, 10%, X7R, ROHS	GENERIC
11	C8	0	SNUBBER CAP, DNP	
12	C304, C308	2	CAP, SMD, 0603, 1μF, 6.3V, 10%, X7R, ROHS	GENERIC
13	C31	1	CAP, SMD, 0603, 0.01μF, 25V, 20%, X7R, ROHS	GENERIC
14	C4	1	CAP, SMD, 0603, 0.047μF, 25V, 10%, X7R, ROHS	GENERIC
15	C5	1	CAP, SMD, 0603, 0.22μF, 25V, 20%, X7R, ROHS	GENERIC
16	C9	1	CAP, SMD, 0603, 1μF, 16V, 20%, X7R, ROHS	GENERIC
17	D1	1	DIODE, SMD, SOT23, BAT54, ROHS	GENERIC
18	F325	1	FUSE, SMD, MICROSMD050F	RAYCHEM-TYCO
19	J1, J3, J6	3	JACK, BANANA, BLACK, 164-6218	MOUSER
20	J2, J4, J5	3	JACK, BANANA, RED, 164-6219	MOUSER
21	J301	1	CONNECTOR, USB, TYPE B, 897-30-004-90-000	MIL-MAX
22	J9, J_PHASE, J_SYSTEM	3	TEST POINT, SCOPE PROBE, 131-5031-00	TEKTRONIX
23	L1A	1	INDUCTOR, SMD, 4.7μH, 9.5A, IHLP4040DZER4R7M01	VISHAY/DALE
24	Q_AGATE, Q_BGATE, Q_SGATE	3	MOSFET, P-CH, SMD, LPAK, 30V, 40A, HAT1127H	RENESAS
25	R1	1	RES, SMD, 0603, 3.01k, 1/10W, 1%, TF, ROHS	GENERIC
26	R2	1	RES, SMD, 0603, 56.2k, 1/10W, 1%, TF, ROHS	GENERIC
27	R_ICOMP	1	RES, SMD, 0603, 0Ω, 1/10W, TF, ROHS	GENERIC
28	R10, R14	2	RES, SMD, 0603, 10, 1/10W, 5%, TF, ROHS	GENERIC
29	R13	0	DNP	
30	R15	1	RES, SMD, 0603, 4.7Ω, 1/10W, 5%, TF, ROHS	GENERIC
31	R17	1	SNUBBER RESISTOR, DNP	
32	R22	1	CELLS PULL DOWN RESISTOR, DNP	
33	R23	1	RES, SMD, 0603, 2.2Ω, 1/10W, 5%, TF, ROHS	GENERIC
34	R24, R25, R44, R302, R303, R307, R309, R312, R313, R399, RF22	11	RES, SMD, 2010, 0Ω, 1/2W, 5%, TF, ROHS	GENERIC
35	R27	1	RES, SMD, 2010, 0Ω, 1/2W, 5%, TF, ROHS	GENERIC
36	R3, R8, R9, R52, R91	5	RES, SMD, 0603, 100k, 1/10W, 1%, TF, ROHS	GENERIC
37	R304, R305	2	RES, SMD, 0603, 1k, 1/10W, 1%, TF, ROHS	GENERIC

TABLE 1. ISL9519CEVAL1Z, REV A EVALUATION BOARD BILL OF MATERIALS (Continued)

NO.	REF DES	QTY	DESCRIPTION	MANUFACTURER
38	R310, R311	2	RES, SMD, 0603, 1.8k, 1/10W, 5%, TF, ROHS	GENERIC
39	R4, R7, R11, R12, R16	5	RES, SMD, 0603, 10.0k, 1/10W, 1%, TF, ROHS	GENERIC
40	R5	1	RES, SMD, 0603, 33 $\Omega$ , 1/10W, 5%, TF, ROHS	GENERIC
41	R6	1	RES, SMD, 0603, 27k, 1/10W, 5%, TF, ROHS	GENERIC
42	RS1	1	RES, SMD, 2010, 0.02 $\Omega$ , 1W, 1%, LRC-LRF2010-01-R020-F	IRC
43	RS2	1	RES, SMD, 2010, 0.01 $\Omega$ , 1W, 1%, LRC-LRF2010-01-R010-F	IRC
44	TP_ACIN, TP_ACOK, TP_AMON, TP_VFRQ, TP_ICOMP, TP_VCOMP, TP_SMB_RST_N	7	TEST POINT, 0.063", COMPACT YELLOW, CTP5009	KEYSTONE
45	TP_DCIN, TP_AGATE, TP_BGATE, TP_GND_1, TP_GND2, TP_GND_3, TP_RS1_N, TP_RS2_N, TP_SGATE, TP_GNDA_1, TP_GNDA_2	11	TEST POINT, 0.063", COMPACT BLACK, CTP5006	KEYSTONE
46	TP_VDD, TP_VBAT, TP_VDDP, TP_VADAPTER, TP_V_SYSTEM	5	TEST POINT, 0.063", COMPACT RED, CTP5005	KEYSTONE
47	TP304, TP305, TP306, TP_SCL, TP_SDA, TP_VHST, TP_GND_D, TP_RS1_P, TP_RS2_P	9	TEST POINT, 0.063", COMPACT WHITE, CTP5007	KEYSTONE
48	U1	1	IC, BATTERY CHARGER, ISL9519C, QFN50_5X7B_EP	INTERSIL
49	U301	1	IC, MICROCONTROLLER, C8051F320, 32LQFP_80	SILICON LABS



ISL9519C EVAL1Z REV A S/N

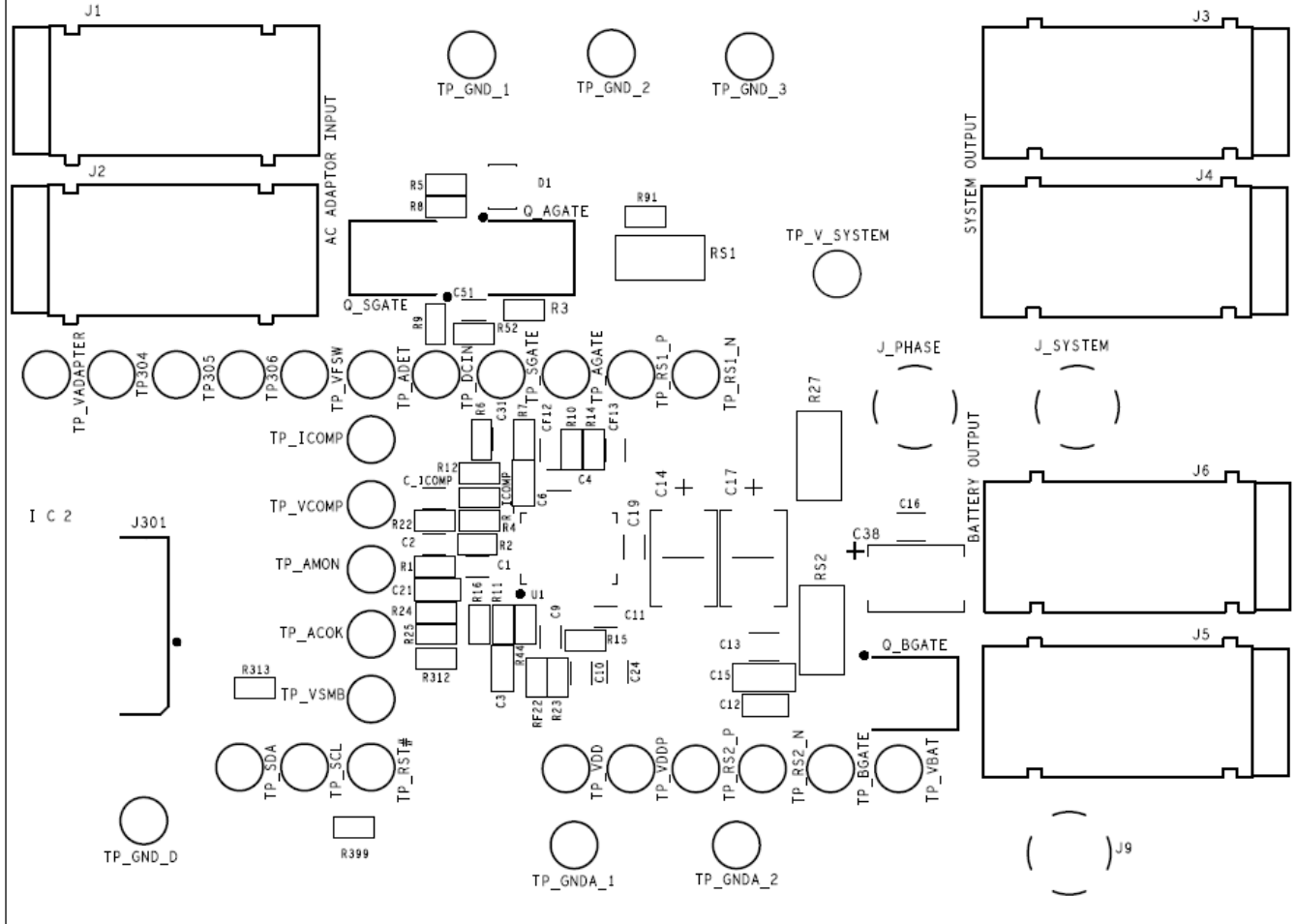

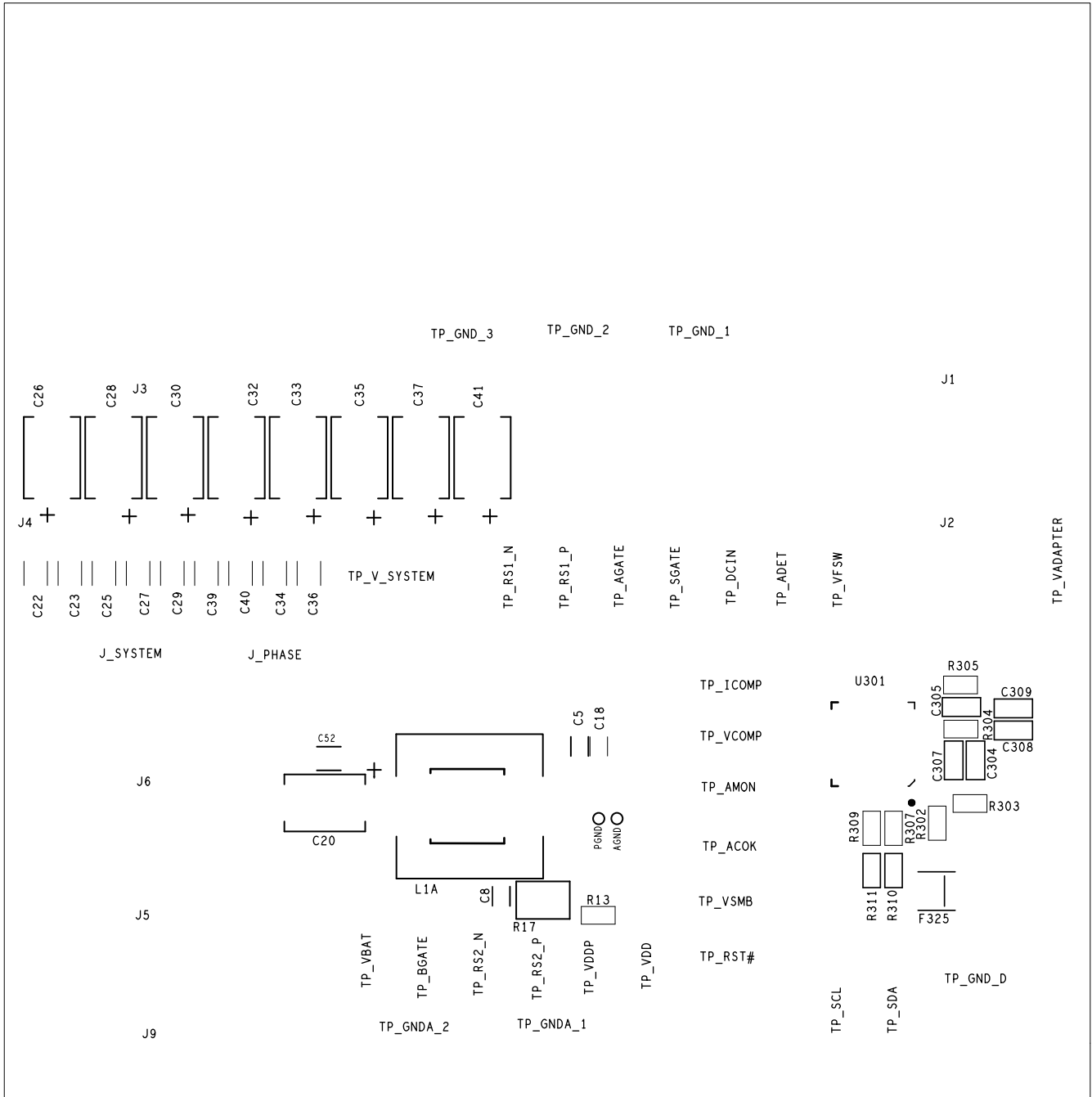

FIGURE 18. BOTTOM SILKSCREEN

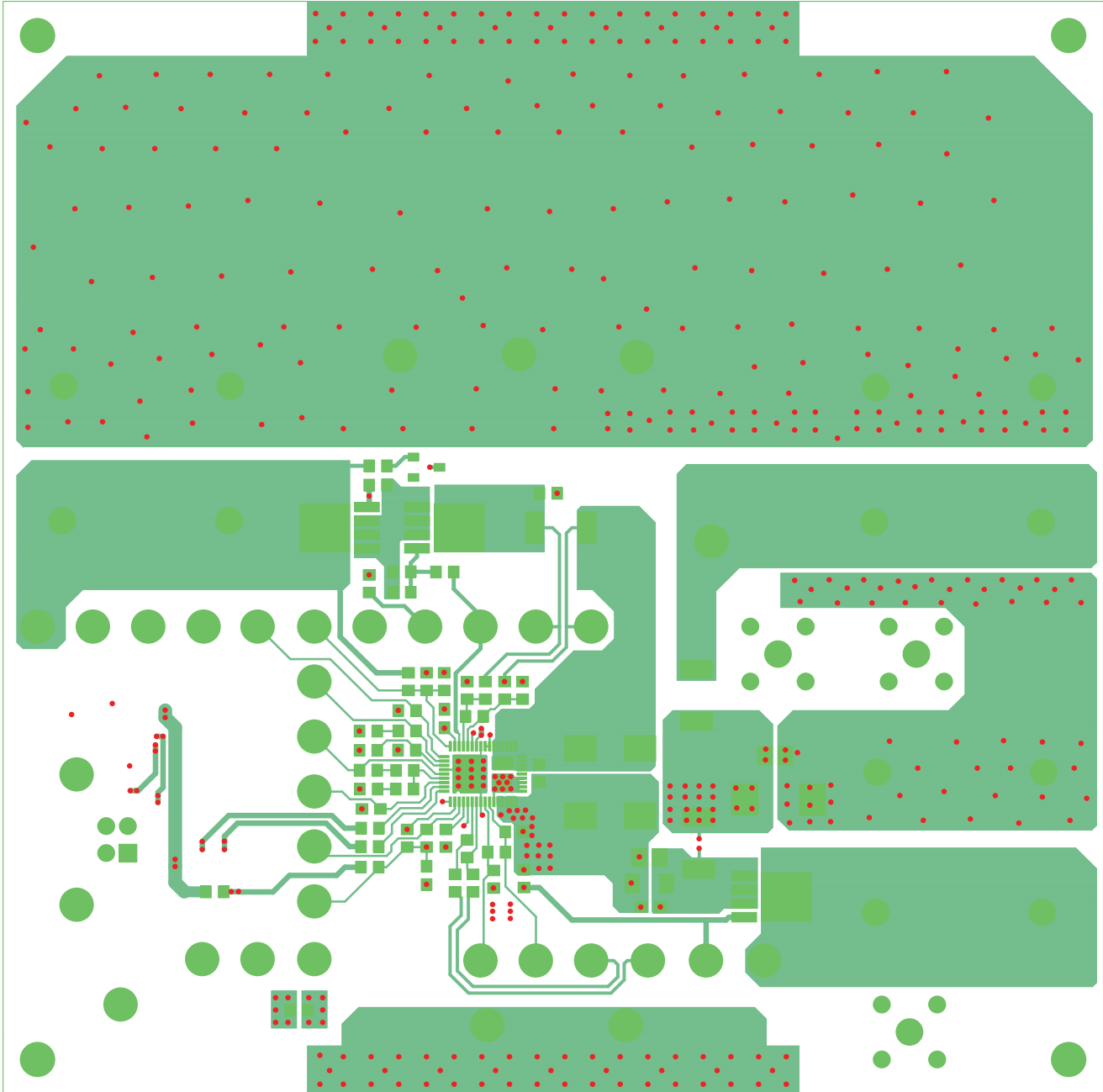

FIGURE 19. TOP LAYER COPPER

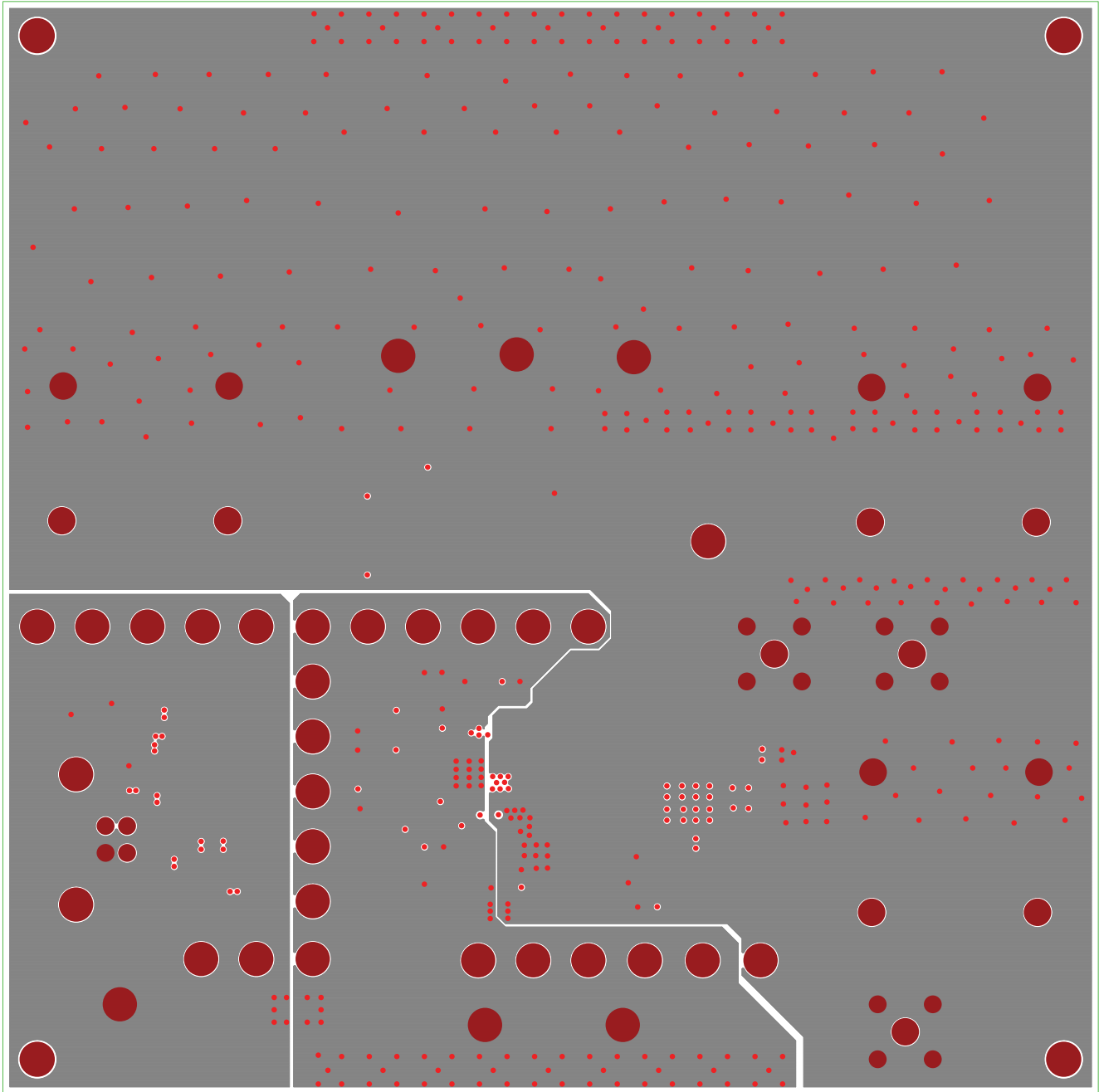

FIGURE 20. LAYER 2 COPPER

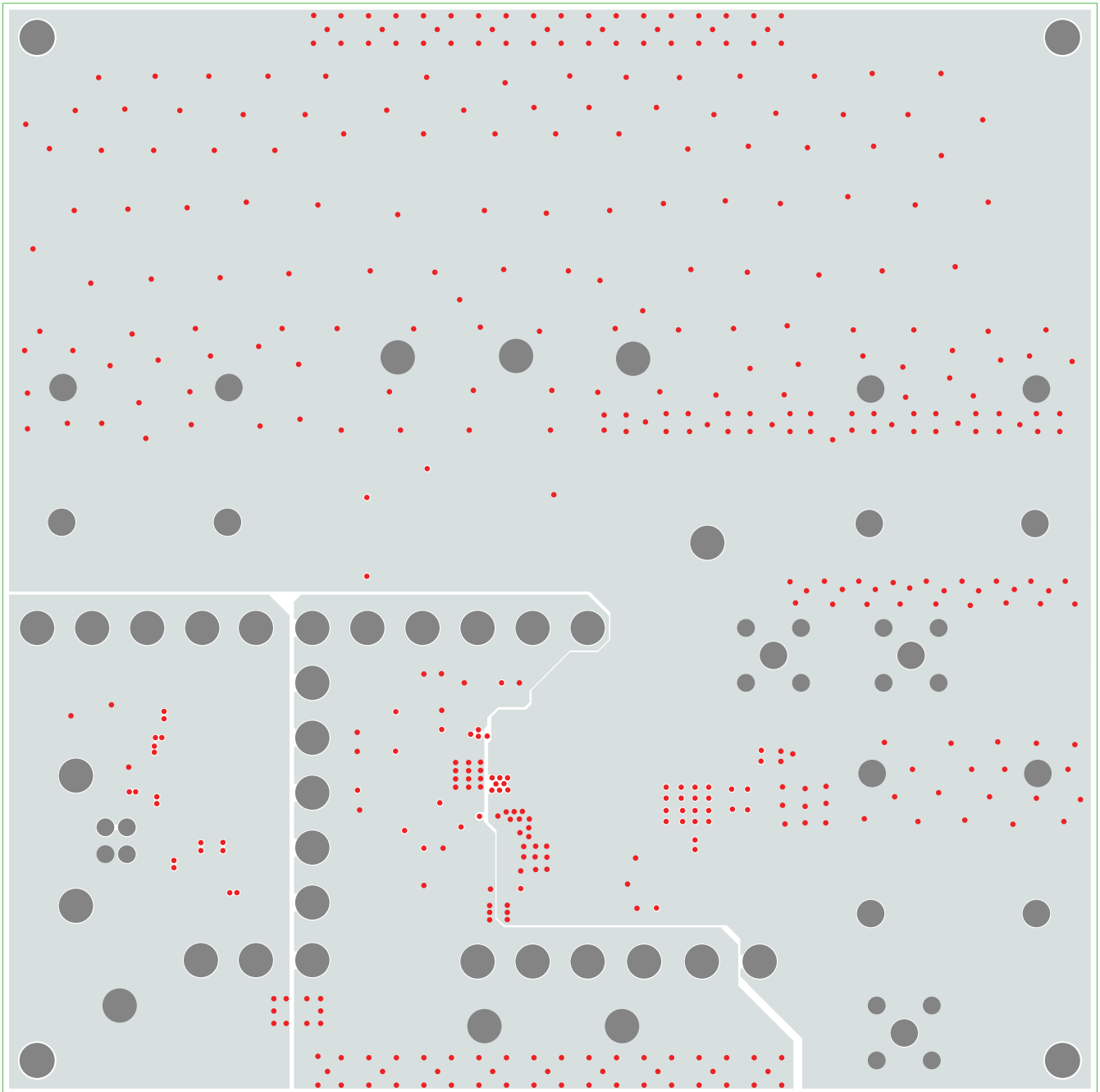

FIGURE 21. LAYER 3 COPPER



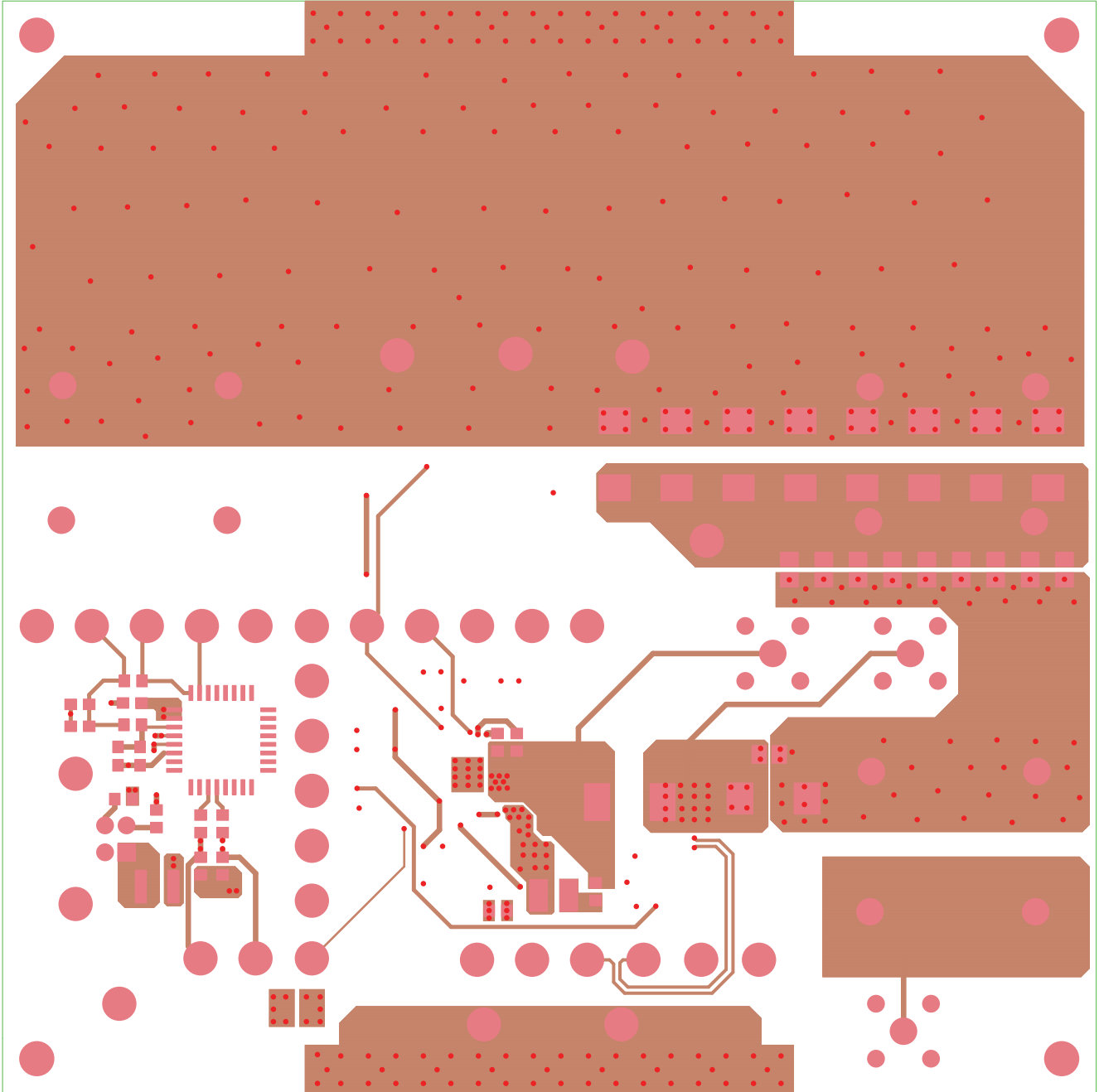

FIGURE 22. BOTTOM LAYER COPPER

## Notice

1. Descriptions of circuits, software and other related information in this document are provided only to illustrate the operation of semiconductor products and application examples. You are fully responsible for the incorporation or any other use of the circuits, software, and information in the design of your product or system. Renesas Electronics disclaims any and all liability for any losses and damages incurred by you or third parties arising from the use of these circuits, software, or information.
2. Renesas Electronics hereby expressly disclaims any warranties against and liability for infringement or any other claims involving patents, copyrights, or other intellectual property rights of third parties, by or arising from the use of Renesas Electronics products or technical information described in this document, including but not limited to, the product data, drawings, charts, programs, algorithms, and application examples.
3. No license, express, implied or otherwise, is granted hereby under any patents, copyrights or other intellectual property rights of Renesas Electronics or others.
4. You shall not alter, modify, copy, or reverse engineer any Renesas Electronics product, whether in whole or in part. Renesas Electronics disclaims any and all liability for any losses or damages incurred by you or third parties arising from such alteration, modification, copying or reverse engineering.
5. Renesas Electronics products are classified according to the following two quality grades: "Standard" and "High Quality". The intended applications for each Renesas Electronics product depends on the product's quality grade, as indicated below.  
"Standard": Computers; office equipment; communications equipment; test and measurement equipment; audio and visual equipment; home electronic appliances; machine tools; personal electronic equipment; industrial robots; etc.  
"High Quality": Transportation equipment (automobiles, trains, ships, etc.); traffic control (traffic lights); large-scale communication equipment; key financial terminal systems; safety control equipment; etc.  
Unless expressly designated as a high reliability product or a product for harsh environments in a Renesas Electronics data sheet or other Renesas Electronics document, Renesas Electronics products are not intended or authorized for use in products or systems that may pose a direct threat to human life or bodily injury (artificial life support devices or systems; surgical implantations; etc.), or may cause serious property damage (space system; undersea repeaters; nuclear power control systems; aircraft control systems; key plant systems; military equipment; etc.). Renesas Electronics disclaims any and all liability for any damages or losses incurred by you or any third parties arising from the use of any Renesas Electronics product that is inconsistent with any Renesas Electronics data sheet, user's manual or other Renesas Electronics document.
6. When using Renesas Electronics products, refer to the latest product information (data sheets, user's manuals, application notes, "General Notes for Handling and Using Semiconductor Devices" in the reliability handbook, etc.), and ensure that usage conditions are within the ranges specified by Renesas Electronics with respect to maximum ratings, operating power supply voltage range, heat dissipation characteristics, installation, etc. Renesas Electronics disclaims any and all liability for any malfunctions, failure or accident arising out of the use of Renesas Electronics products outside of such specified ranges.
7. Although Renesas Electronics endeavors to improve the quality and reliability of Renesas Electronics products, semiconductor products have specific characteristics, such as the occurrence of failure at a certain rate and malfunctions under certain use conditions. Unless designated as a high reliability product or a product for harsh environments in a Renesas Electronics data sheet or other Renesas Electronics document, Renesas Electronics products are not subject to radiation resistance design. You are responsible for implementing safety measures to guard against the possibility of bodily injury, injury or damage caused by fire, and/or danger to the public in the event of a failure or malfunction of Renesas Electronics products, such as safety design for hardware and software, including but not limited to redundancy, fire control and malfunction prevention, appropriate treatment for aging degradation or any other appropriate measures. Because the evaluation of microcomputer software alone is very difficult and impractical, you are responsible for evaluating the safety of the final products or systems manufactured by you.
8. Please contact a Renesas Electronics sales office for details as to environmental matters such as the environmental compatibility of each Renesas Electronics product. You are responsible for carefully and sufficiently investigating applicable laws and regulations that regulate the inclusion or use of controlled substances, including without limitation, the EU RoHS Directive, and using Renesas Electronics products in compliance with all these applicable laws and regulations. Renesas Electronics disclaims any and all liability for damages or losses occurring as a result of your noncompliance with applicable laws and regulations.
9. Renesas Electronics products and technologies shall not be used for or incorporated into any products or systems whose manufacture, use, or sale is prohibited under any applicable domestic or foreign laws or regulations. You shall comply with any applicable export control laws and regulations promulgated and administered by the governments of any countries asserting jurisdiction over the parties or transactions.
10. It is the responsibility of the buyer or distributor of Renesas Electronics products, or any other party who distributes, disposes of, or otherwise sells or transfers the product to a third party, to notify such third party in advance of the contents and conditions set forth in this document.
11. This document shall not be reprinted, reproduced or duplicated in any form, in whole or in part, without prior written consent of Renesas Electronics.
12. Please contact a Renesas Electronics sales office if you have any questions regarding the information contained in this document or Renesas Electronics products.  
(Note 1) "Renesas Electronics" as used in this document means Renesas Electronics Corporation and also includes its directly or indirectly controlled subsidiaries.  
(Note 2) "Renesas Electronics product(s)" means any product developed or manufactured by or for Renesas Electronics.

(Rev.4.0-1 November 2017)



### SALES OFFICES

Renesas Electronics Corporation

<http://www.renesas.com>

Refer to "<http://www.renesas.com/>" for the latest and detailed information.

**Renesas Electronics America Inc.**  
1001 Murphy Ranch Road, Milpitas, CA 95035, U.S.A.  
Tel: +1-408-432-8888, Fax: +1-408-434-5351

**Renesas Electronics Canada Limited**  
9251 Yonge Street, Suite 8309 Richmond Hill, Ontario Canada L4C 9T3  
Tel: +1-905-237-2004

**Renesas Electronics Europe Limited**  
Dukes Meadow, Millboard Road, Bourne End, Buckinghamshire, SL8 5FH, U.K  
Tel: +44-1628-651-700, Fax: +44-1628-651-804

**Renesas Electronics Europe GmbH**  
Arcadiastrasse 10, 40472 Düsseldorf, Germany  
Tel: +49-211-6503-0, Fax: +49-211-6503-1327

**Renesas Electronics (China) Co., Ltd.**  
Room 1709 Quantum Plaza, No.27 ZhichunLu, Haidian District, Beijing, 100191 P. R. China  
Tel: +86-10-8235-1155, Fax: +86-10-8235-7679

**Renesas Electronics (Shanghai) Co., Ltd.**  
Unit 301, Tower A, Central Towers, 555 Langao Road, Putuo District, Shanghai, 200333 P. R. China  
Tel: +86-21-2226-0888, Fax: +86-21-2226-0999

**Renesas Electronics Hong Kong Limited**  
Unit 1601-1611, 16/F., Tower 2, Grand Century Place, 193 Prince Edward Road West, Mongkok, Kowloon, Hong Kong  
Tel: +852-2265-6688, Fax: +852-2886-9022

**Renesas Electronics Taiwan Co., Ltd.**  
13F, No. 363, Fu Shing North Road, Taipei 10543, Taiwan  
Tel: +886-2-8175-9600, Fax: +886-2-8175-9670

**Renesas Electronics Singapore Pte. Ltd.**  
80 Bendemeer Road, Unit #06-02 Hyflux Innovation Centre, Singapore 339949  
Tel: +65-6213-0200, Fax: +65-6213-0300

**Renesas Electronics Malaysia Sdn.Bhd.**  
Unit 1207, Block B, Menara Amcorp, Amcorp Trade Centre, No. 18, Jln Persiaran Barat, 46050 Petaling Jaya, Selangor Darul Ehsan, Malaysia  
Tel: +60-3-7955-9390, Fax: +60-3-7955-9510

**Renesas Electronics India Pvt. Ltd.**  
No.777C, 100 Feet Road, HAL 2nd Stage, Indiranagar, Bangalore 560 038, India  
Tel: +91-80-67208700, Fax: +91-80-67208777

**Renesas Electronics Korea Co., Ltd.**  
17F, KAMCO Yangjae Tower, 262, Gangnam-daero, Gangnam-gu, Seoul, 06265 Korea  
Tel: +82-2-558-3737, Fax: +82-2-558-5338