

ZSSC3241

Sensor Signal Conditioner IC for Resistive Sensors

Description

ZSSC3241 SSC Evaluation Kit is designed for sensor module evaluation, laboratory setup, and module calibration development for the ZSSC3241 Sensor Signal Conditioner (SSC).

The main purpose of the ZSSC3241 Evaluation Kit is to enable the communication between the user and the ZSSC3241 device with the GUI (Graphical User Interface). The ZSSC3241-GUI establishes the communication via a USB port (configured as a virtual COM port) to the SSC Communication Board (CB). The microcontroller on the SSC CB interprets these commands, converts them to the configured interface (I2C, SPI, or OWI), and provides it to the ZSSC3241 located on the ZSSC3241 SSC Evaluation Board.

Almost all possible applications can be tested with the Evaluation Kit and the GUI, so that the customer can easily get the first experience and also evaluate in detail the ZSSC3241 functionalities.

Kit Contents

- ZSSC3241 Evaluation Board - ZSSC3241EVB
- SSC Communication board (CB)
- Sensor Replacement Board (SRB)
- ZSSC3241 24-PQFN 4mm × 4mm samples (5 pcs)
- USB Cable

Features

- Implemented I2C, SPI, or OWI interface options for customer specific communication.
- Connections for user's real sensor module
- Sensor Replacement Board for sensor emulation
- "Dry-run" calibration and calibration examples
- Immediate applications of any functionalities
- Modular design of kit components for evaluation
- Clamshell 24-PQFN socket for ZSSC3241 device under test (DUT)
- Support multi-DUT usage without soldering
- Product specific, powerful GUI (Graphical User Interface)
- AFE configurator
- AD / DA processing path transparency

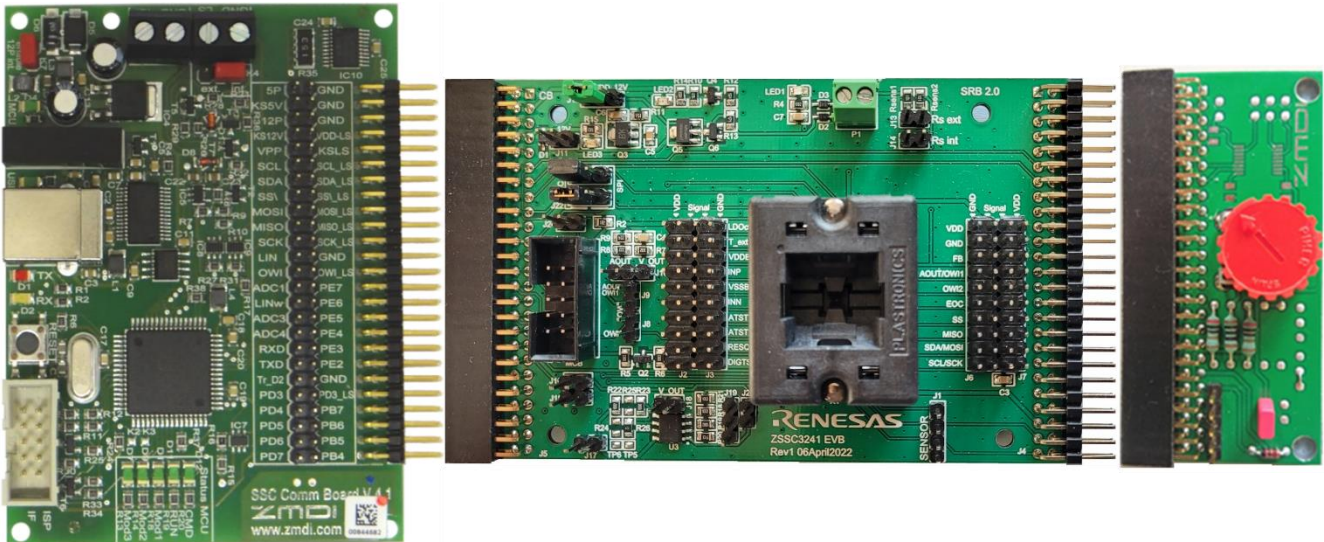

Figure 1. ZSSC3241 Evaluation Kit

Disclaimer

Integrated Device Technology, Inc. and its affiliated companies (herein referred to as “RENESAS”) shall not be liable for any damages arising out of defects resulting from

- (i) delivered hardware or software
- (ii) non-observance of instructions contained in this manual and in any other documentation provided to user, or
- (iii) misuse, abuse, use under abnormal conditions, or alteration by anyone other than RENESAS.

TO THE EXTENT PERMITTED BY LAW, RENESAS HEREBY EXPRESSLY DISCLAIMS AND USER EXPRESSLY WAIVES ANY AND ALL WARRANTIES, WHETHER EXPRESS, IMPLIED, OR STATUTORY, INCLUDING, WITHOUT LIMITATION, IMPLIED WARRANTIES OF MERCHANTABILITY AND OF FITNESS FOR A PARTICULAR PURPOSE, STATUTORY WARRANTY OF NON-INFRINGEMENT, AND ANY OTHER WARRANTY THAT MAY ARISE BY REASON OF USAGE OF TRADE, CUSTOM, OR COURSE OF DEALING.

Restrictions in Use

RENESAS’s ZSSC3241, consisting of the SSC Communication Board (SSC CB), ZSSC3241 Evaluation Board (SSC EB), SSC Sensor Replacement Board (SSC RB), and ZSSC3241 Software, is designed for module evaluation, laboratory setup, and module calibration development only. RENESAS’s ZSSC3241 hardware and software must not be used for module production or production test setups.



Important Equipment Warning: Ensure the correct connection of all cables. Supplying the board using the wrong polarity could result in damage to the board and/or the equipment. Check that all jumpers have been removed from the board before applying power.

Contents

1. Evaluation Kit Setup	6
1.1 User Computer Requirements and Setup	6
1.1.1. Computer Requirements	6
1.1.2. Software Installation and Setup	7
1.2 Evaluation Board Configuration and Connections	7
1.3 Communication Interfaces	10
1.4 Power Supply Options	10
1.5 Start-up Evaluation Kit HW	10
2. GUI	13
2.1 Menu Bar	14
2.1.1. NVM Control	14
2.1.2. Interface Setup	14
2.2 Active Interface	16
2.3 Measurement Control	16
2.3.1. Measurement Commands	16
2.4 Display Control	17
2.5 Logging Options	18
2.5.1. Communication Log	18
2.5.2. Measurement Data Log	19
2.6 Status	19
2.6.1. IC-Status	19
2.6.2. Hardware Connection	20
2.6.3. Sensor and Temperature Readings	21
2.7 Tabs	21
2.7.1. Measurement Tab	21
2.7.2. NVM Tab	21
2.7.3. Calibration Tab	24
2.7.4. Diagnostic / Cyclic Configuration / Command Section Tab	27
2.7.5. AFE Configuration Tab	31
2.8 Information Bar	34
2.9 Main Buttons	34
3. Glossary	35
4. Ordering Information	36
5. Revision History	36

Figures

Figure 1. ZSSC3241 Evaluation Kit	2
Figure 2. Connected ZSSC3241 Evaluation Kit	6
Figure 3. ZSSC3241 SSC Evaluation Board – Overview	7
Figure 4. Communication Board LED Status after Initialization	11
Figure 5. Initial Jumper Setting ZSSC3241 Evaluation Board.....	11
Figure 6. Evaluation Board LED Status after Starting GUI.....	12
Figure 7. Initial GUI Display	12
Figure 8. ZSSC3241 GUI Sections.....	13
Figure 9. Extract of an NVM Configuration File	14
Figure 10. Interface Quick Selection	14
Figure 11. Communication Interface Configuration Options	15
Figure 12. Interface Setting Display	16
Figure 13. Measurement Control Section.....	16
Figure 14. SSC-Measurement Command Choice	16
Figure 15. Raw Command Measurement Options	17
Figure 16. Measurements Display	17
Figure 17. External Sensor Results Display in Percent.....	17
Figure 18. ADC Resolution from ZSSC3241 to GUI.....	18
Figure 19. Logging Options	18
Figure 20. Communication Log Examples.....	19
Figure 21. IC-Status Display.....	19
Figure 22. HW Connection Status	20
Figure 23. Numerical Display Measurement Results	21
Figure 24. NVM Table.....	22
Figure 25. Parameter to Register Assignment	22
Figure 26. EOC Interrupt Thresholds	23
Figure 27. Calibration Tab	24
Figure 28. Activate Analog Calibration	26
Figure 29. Calibration Choice Guidance.....	26
Figure 30. Raw Data to Calibrated Data in Percentage	27
Figure 31. Diagnostic / Cyclic Configuration / Command Section Tab	27
Figure 32. DAC-Diagnostic	27
Figure 33. DAC SSC Calibration	28
Figure 34. Diagnostic Result Example	29
Figure 35. Read/Write Operations via Terminal	30
Figure 36. Cyclic Sequencer Section	30
Figure 37. AFE Configuration Tab.....	31
Figure 38. Sensor Characteristic	32
Figure 39. Example AFE Configurator Usage	32
Figure 40. Parameter Description Depending on Sensor Type.....	33
Figure 41. Sensor Signal Processing	33
Figure 42. Raw Measurement Calculator	34
Figure 43. Information Bar	34

Tables

Table 1. Signal Connections to the Communication Board	8
Table 2. Signal Connections to the SRB	8
Table 3. Sensor Signals at Connectors on EB	8
Table 4. LEDs on EB	8
Table 5. Connectors and Headers	9
Table 6. Jumper Settings for Voltage Output Selection	9
Table 7. Jumper Settings for Current Loop Selection	9
Table 8. Jumper Settings for Digital Interface Selection	10
Table 9. Power Supply Selection	10
Table 10. IC-Status Indicators	20
Table 11. Supported Default Calibration Types	24
Table 12. Calibration Table Parameters	25

1. Evaluation Kit Setup

This document describes the ZSSC3241 Evaluation Kit, including the hardware components, the product-specific configuration, the ZSSC3241 Evaluation Software, and its installation. The software is designed for Windows®-based operating systems to communicate with the ZSSC3241 Evaluation Kit via an USB connection to the master PC on user's side.

Three boards are included in the ZSSC3241 Evaluation Kit:

- Communication Board (CB) - The SSC Communication Board V4.1 provides power supply for the evaluation hardware and handles the communication with a PC via a USB interface. The Communication Board features digital isolators onboard for the information lines and an isolated DC/DC converter for the power line, which provide galvanic isolation between the PC's USB port and the evaluation board.
- Evaluation Board (EB) – The EB provides the required circuitry for the operation, evaluation, and calibration of the ZSSC3241 device under test. It also has a connection to a sensor replacement device or to a user sensor.

Note: Only one user sensor or the SRB must be connected to the Evaluation Board at any given time.

- Sensor Replacement Board (SRB) can be connected to the EB as a replacement for an actual sensor and can be used for the first step of a calibration demonstration or a dry-run calibration.

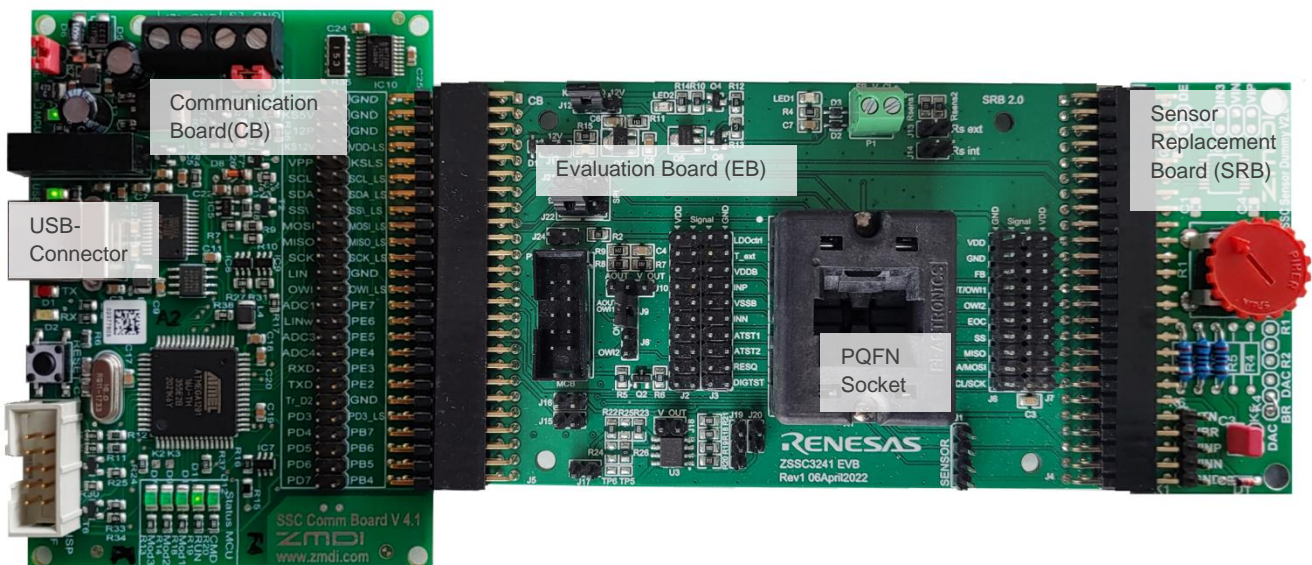

Figure 2. Connected ZSSC3241 Evaluation Kit

1.1 User Computer Requirements and Setup

1.1.1. Computer Requirements

A Windows®-based computer is required for interfacing with the kit and configuring the part. The user must have administrative rights on the computer to download and install the Evaluation Software for the kit.

The computer must meet the following requirements:

- Windows® XP SP3, Vista SP1 or later, 7 (including SP1), 8, 8.1, 10
- Supported architecture: x86 and x64
- Available USB port

Optional equipment:

- The ZSSC3241 power (VDD) can be supplied by the user's external power supply. See section 1.4 for connection details.
- DC Voltmeter 0V to 50V and DC Amperemeter (0mA to 100mA)
- 4 channel 100MHz Oscilloscope

1.1.2. Software Installation and Setup

The ZSSC3241 Evaluation Software is not part of the Evaluation Kit packet; it is shared via the responsible Renesas team members.

Note: FTDI USB drivers are needed for proper communication. If these drivers are not already installed on the user's computer, they can be downloaded from the FTDI's homepage, <https://www.ftdichip.com/FTDrivers.htm>.

Follow the procedure to use the Evaluation Kit Software on the user's computer:

1. Download and extract the zip file to a local computer's drive on the user's computer. The Evaluation Software does not need installation, all drivers and libraries are transferred within the single exe-file.
2. Connect the kit hardware as shown in Figure 2 to the host PC using the provided USB cable.
3. Execute the ZSSC3241_Evaluation_SW_vX.XX.exe file.
This could take some time due to unpacking the file and checking the content by an anti-virus software.

1.2 Evaluation Board Configuration and Connections

See Figure 3 for an overview of the assembled devices, connectors, and jumper on the evaluation board.

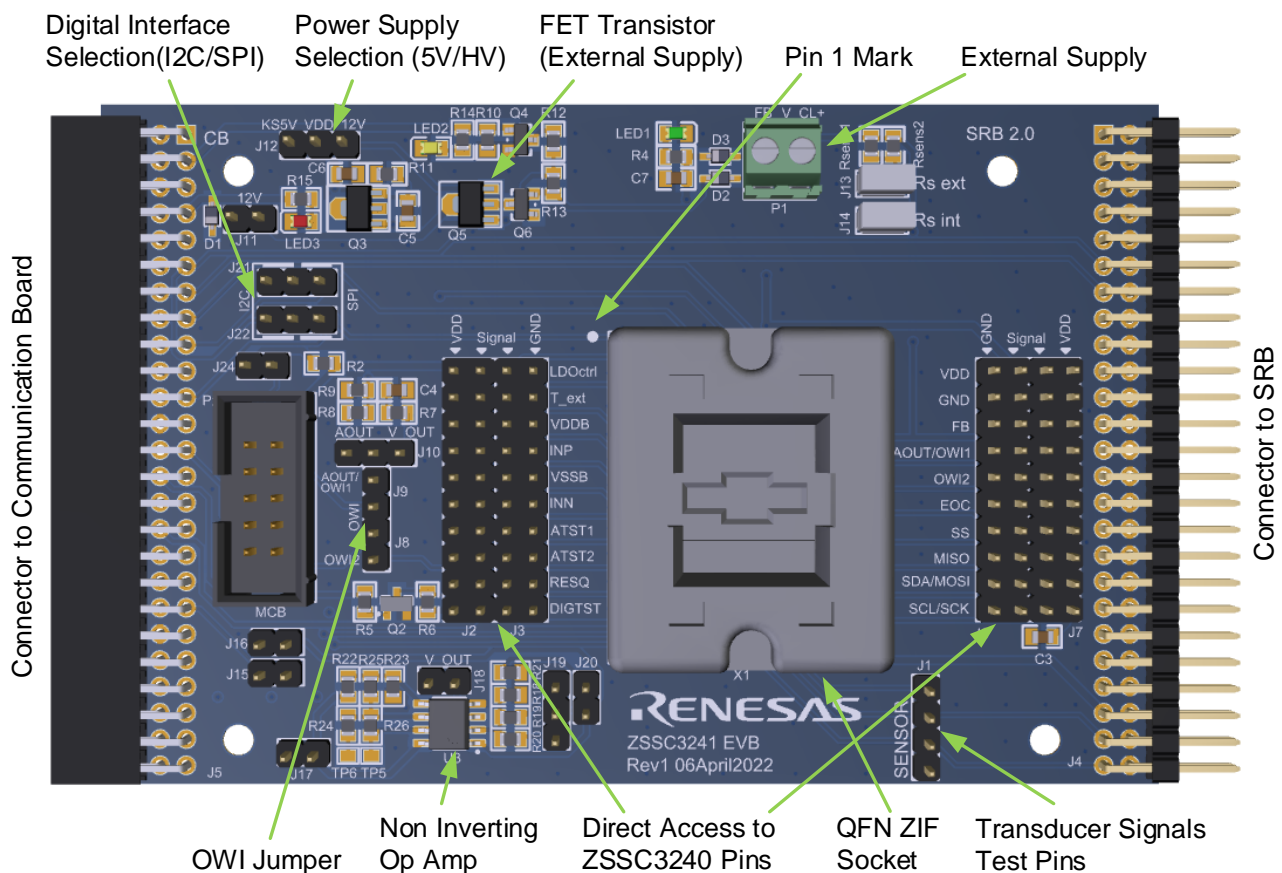

Figure 3. ZSSC3241 SSC Evaluation Board – Overview

The complete list of connected signals between CB and EB is given in Table 1.

Table 1. Signal Connections to the Communication Board

Name	Pin	Description
5P	1	5VDC power supply
KS5P	3	5VDC power supply switch controlled (for timing)
GND	2,4,6,24,40	Ground connection
KS12V	7	12V supply from SSC COMM BOARD
SCL/SDA	11,13	I2C interface, logic level
MISO, MOSI, SCK, SS	15,17,19,21	SPI interface, 5V logic (used for SSC EB identification by I2C).
OWI	25	One Wire Interface
PE7	28	GPIO control with internal pull-up resistors used to reset the ZSSC3241.
PD3	41	Control signal to the EOC (End of Conversion) pin of the ZSSC3241; logic level defined by the VDD
PD4	43	Bi-directional I/O port with internal pull-up resistors
PD7	49	PD7 U2 8-bit serial shift register settings on EB; set by the ZSSC3241 Evaluation Software

The SRB can be used instead of a real sensor module as a sensor emulator to gain experience with Evaluation Kit and SW. The connected signals between the EB and SRB are listed in Table 2.

Table 2. Signal Connections to the SRB

Name	Pin	Description
5P	1	5VDC
GND	2, 4,...,48,50	Ground
SCL	11	I2C clock
SDA	13	I2C data
VSSB	43	Bridge negative supply voltage
VDDB	45	Bridge positive supply voltage
INP	47	Bridge positive signal
INN	49	Bridge negative signal

The sensor signals leading to the ZSSC3241 are accessible at different connectors. Table 3 shows connectors and pins for possible connection and monitoring purposes.

Table 3. Sensor Signals at Connectors on EB

Signal	J1	J2	J3	J4
VDDB	1	6	5	45
INP	3	8	7	47
INN	2	12	11	49
VSSB	4	10	9	43

The EB has three different LEDs for a quick optical caption for a possible supply voltage at the board. Table 4 contains the assignment between LED number, color, and voltage.

Table 4. LEDs on EB

Connector	Type	Description
LED1	Green	Indication for presence of ZSSC3241 VDD voltage
LED2	Yellow	Indication for presence of KS5V voltage
LED3	Red	Indication for presence of KS12V voltage

Table 5 provides a summary of all possible connectors and headers available at the EB.

Table 5. Connectors and Headers

Connector	Type	Description
J1	4-Pin Header	Sensor signal connections
X1	24-Pin ZIF socket	ZSSC3241 socket
J2, J3, J6, J7	2-10-Pin Header	Direct access to the pins of the ZSSC3241. Each IC pin can be connected to VDD or GND with an optional 2.54mm jumper
J4	2-25-Pin Header	Connector between EB and SRB
J5	2-25-Pin Header	Connector between CB and EB
J8	2-Pin Header	Optional OWI input connection to OWI2
J9	2-Pin Header	Necessary connection for OWI communication between ZSSC3241-AOUT/OWI1 pin and the CB OWI signal
J10	3-Pin Header	Jumper at pins 1-2 connects the analog ZSSC3241 output to an RC-filter. Pins 2 and 3 are shorted. Pin 3 is for optional voltage monitoring with external measurement instruments.
J11	2-Pin Header	Establishes CB connection to supply the EB with 12VDC (in combination with J12 setting)
J12	3-Pin Header	Jumper for selection of the source for the VDD supply: <ul style="list-style-type: none"> KS5V rail, from the CB. Short pins 1-2. KS12V rail, from the CB. Short pins 2-3.
J13	2-Pin Header	Connection for the 50Ω sensing resistor on the EB, mandatory for Current Loop application
J14	2-Pin Header	Optional header for future features, must be open
J15	2-Pin Header	Jumper for routing the 10V output to the optional master PCB via J5
J16	2-Pin Header	Jumper for routing the 5V output to the optional master PCB via J5
J17	2-Pin Header	Jumper for supplying power to the non-inverting amplifier
J18	2-Pin Header	Jumper for connecting the ZSSC3241 voltage output to the non-inverting input of the amplifier
J19	3-Pin Header	Jumper for selecting the gain of the non-inverting amplifier. Connect pins 1 and 2 for gain factor 10, or pins 2 and 3 for gain factor 2
J20	2-Pin Header	Jumper for an optional 10kΩ load resistor at the output of the non-inverting amplifier.
J21	3-Pin Header	Jumper for selecting I2C or SPI communication. Place a jumper between pins 1 and 2 for I2C, or between pins 2 and 3 for SPI operation.
J22	3-Pin Header	Jumper for selecting I2C or SPI communication. Place a jumper between pins 1 and 2 for I2C, or between pins 2 and 3 for SPI operation.
J24	2-Pin Header	Jumper for connecting pull up resistor on the OWI line

The ZSSC3241 has different analog voltage output modes. Depending on the chosen output, jumpers on the Evaluation Board must be set accordingly (see

Table 6).

Table 6. Jumper Settings for Voltage Output Selection

Output	Power			Amplifier			Filter
	J11	J12	P1	J17	J18	J19	J10
0V to 1V	open	1-2	open	open	open	open	open/set ^[a]
0V to 5V	open	1-2	open	open	open	open	open/set ^[a]
0V to 10V	set	2-3	open	set	set	2-3	1-2

[a] An RC-filter can be used by setting J10

Table 7. Jumper Settings for Current Loop Selection

Output	Power			Amplifier			Filter
	J11	J12	P1	J17	J18	J19	J10
Current (powered from CB)	Ammeter	2-3	open	open	open	open	2-3
Current (externally powered)	Pin 2 connected to CL+(P1)	2-3	External Power Supply	open	open	open	2-3

1.3 Communication Interfaces

All three supported digital interfaces (I2C, SPI, and OWI) can be used with the Evaluation Kit for the communication with the ZSSC3241. The desired interface has to be configured in the ZSSC3241 GUI (see Figure 8) as well as on the Evaluation Board by jumpers.

Table 8 shows the required jumper settings for the according interface.

Table 8. Jumper Settings for Digital Interface Selection

Digital Interface	J21	J22	J24	J8 / J9
OWI	X ^[b]	X ^[b]	set	set ^[c]
I2C	1-2	1-2	X ^[b]	open
SPI ^[a]	2-3	2-3	X ^[b]	open

[a] Default

[b] Not relevant, any setting OK

[c] Depending on OWI NVM-Configuration

Since SPI communication does not use any slave addressing, it is configured as the initial interface. I2C or OWI protocol can also be selected, only one can be active a time. Refer to Table 8 for the relevant jumper settings. Section 2.1.2 provides details on the corresponding GUI setup.

1.4 Power Supply Options

Using the Evaluation Kit the ZSSC3241 power supply can be realized in different ways:

- SSC Communication Board KS5V rail, default setting. Direct 5V voltage supply at VDD.
- SSC Communication Board KS12V rail. When supplying the EB with 12V, the voltage is regulated at Q5 to the desired target value between 4.8V and 5.4V at VDD (depending on the ZSSC3241 configuration, refer to ZSSC3241 Datasheet document).
- Externally connected supply greater than 5.5V. The same regulation is used as with SSC CB KS12V rail.

For the correct EB jumper setting see Table 9.

Table 9. Power Supply Selection

Application Supply	J11	J12	P1
5V from CB	open	1-2	open
12V from CB	set	2-3	open
External Source with $V_{SUP} > 5.5V$	open	2-3	External power supply

1.5 Start-up Evaluation Kit HW

Follow these steps for the initial start-up of the Evaluation Kit:

1. Connect the ZSSC3241 Evaluation Board (J5) to the SSC CB v4.1 (K6).
2. Connect the ZSSC3241 Evaluation Board (J4) to the Sensor Replacement Board.
Important: Do not connect the SRB to the SSC EB if a custom sensor module is used.
3. Replace the dummy IC in the socket with an actual ZSSC3241 device under test (DUT).
Important: Orient the pin 1 mark as shown in Figure 3.
4. Connect the USB cable from the USB connector on the CB to an available port on the user's computer.
After initialization, the LEDs on the CB provide its electrical status.
In usual operation mode the LEDs *MCU*, *USB* and *RUN* are on (see Figure 4).

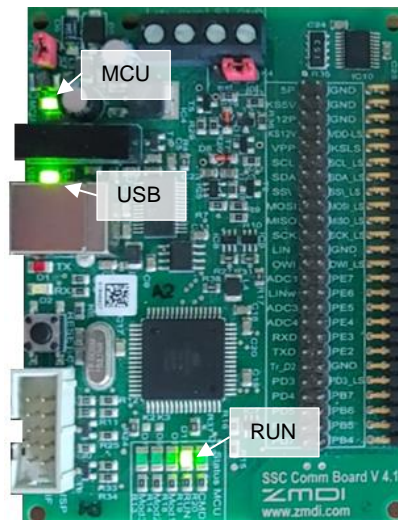

Figure 4. Communication Board LED Status after Initialization

The Evaluation Board is preconfigured for SPI communication and a direct 5V power supply to VDD, coming from the CB. The necessary jumper settings for are the following (see Figure 5):

- JP12: 5V supply at VDD via KS5V (from the CB)
- JP21/22: SPI selection (short SDA/MOSI to MOSI pin and SCL/SCK to SCK pin)

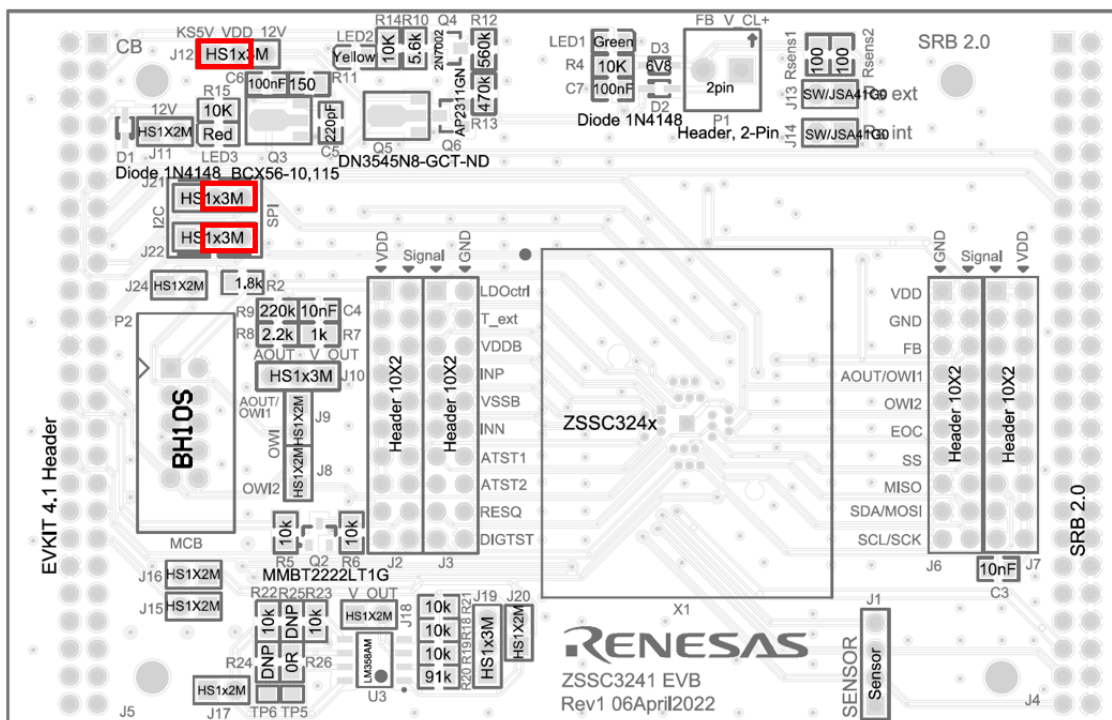

Figure 5. Initial Jumper Setting ZSSC3241 Evaluation Board

5. Run the ZSSC3241_Evaluation_SW_vX.XX.exe from a local drive of the host PC to launch the GUI. If the GUI has established the connection to open the assigned virtual COM port, it powers the ZSSC3241 Evaluation Board from the CB with 5V and it configures SPI as initial communication interface. The power supply from KS5V rail of the CB is indicated by the green LED1 and orange LED2 (see Figure 6) on the EVB, and by highlighting the virtual LEDs **Powered** and **CMD Mode** on the *IC Status* section of the GUI (see Figure 7).



Figure 6. Evaluation Board LED Status after Starting GUI

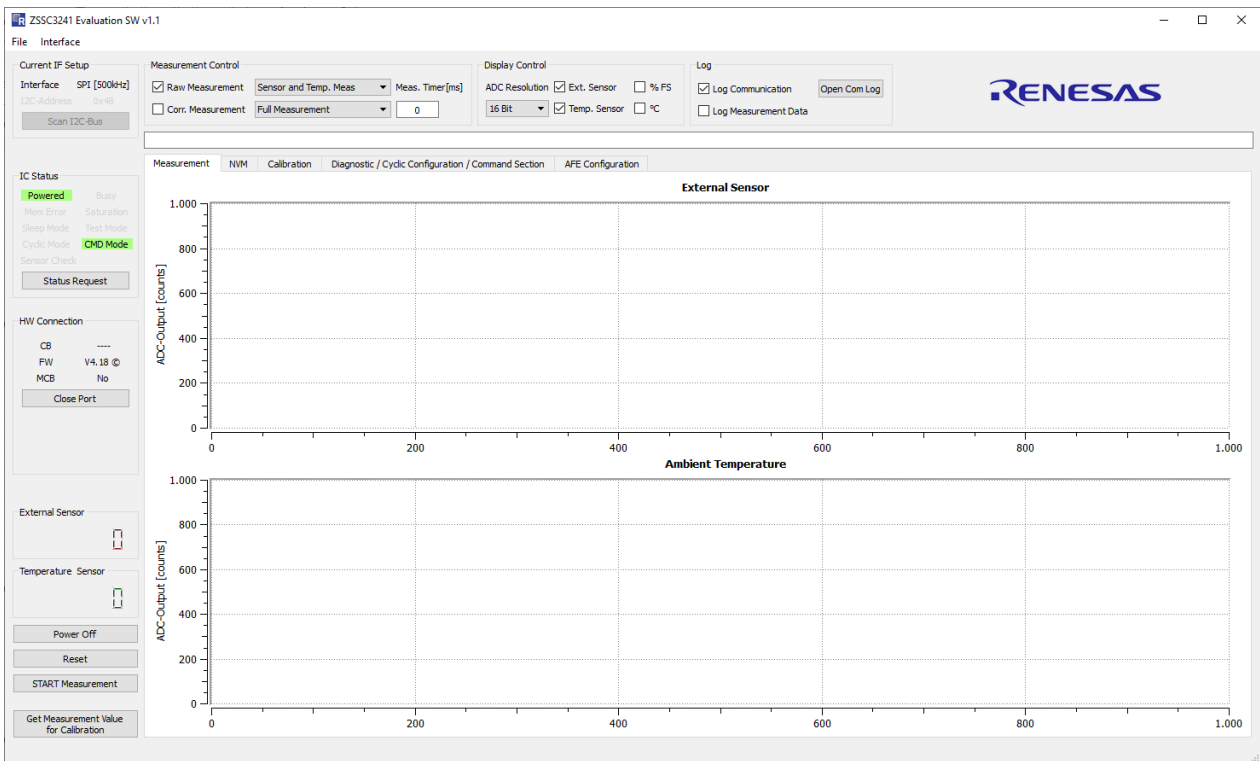

Figure 7. Initial GUI Display

2. GUI

The initial display of the GUI could be divided in nine different sections (see Figure 8), where functional contents and operating instructions are put together to simplify the evaluating process.

1. Menu Bar: capabilities for NVM data transfer and interface configuration changes (see section 2.1).
2. Interface Settings: communication interface selection and its configuration are shown here (see section 2.1.2).
3. Measurement Control: display selection between raw and/or corrected measurement results of both external sensor and temperature (see section 2.3).
4. Display Control: choice of how and which measurement results are displayed on the GUI, for example, ADC resolution (see section 2.4).
5. Logging Options: interface communication and measurement data can be logged (see section 2.5).
6. Status: display of the electrical and functional ZSSC3241 status, recent sensor and temperature reading, and Communication Board information (see section 2.6).
7. Tabs: tabs for different ZSSC3241 function and feature applications (see section 2.7).
8. Information Bar: basic information for some of the operations of the ZSSC3241, for example, coefficients calculating (see section 2.8).
9. Main Buttons: power, reset, measurements (see section 2.9).

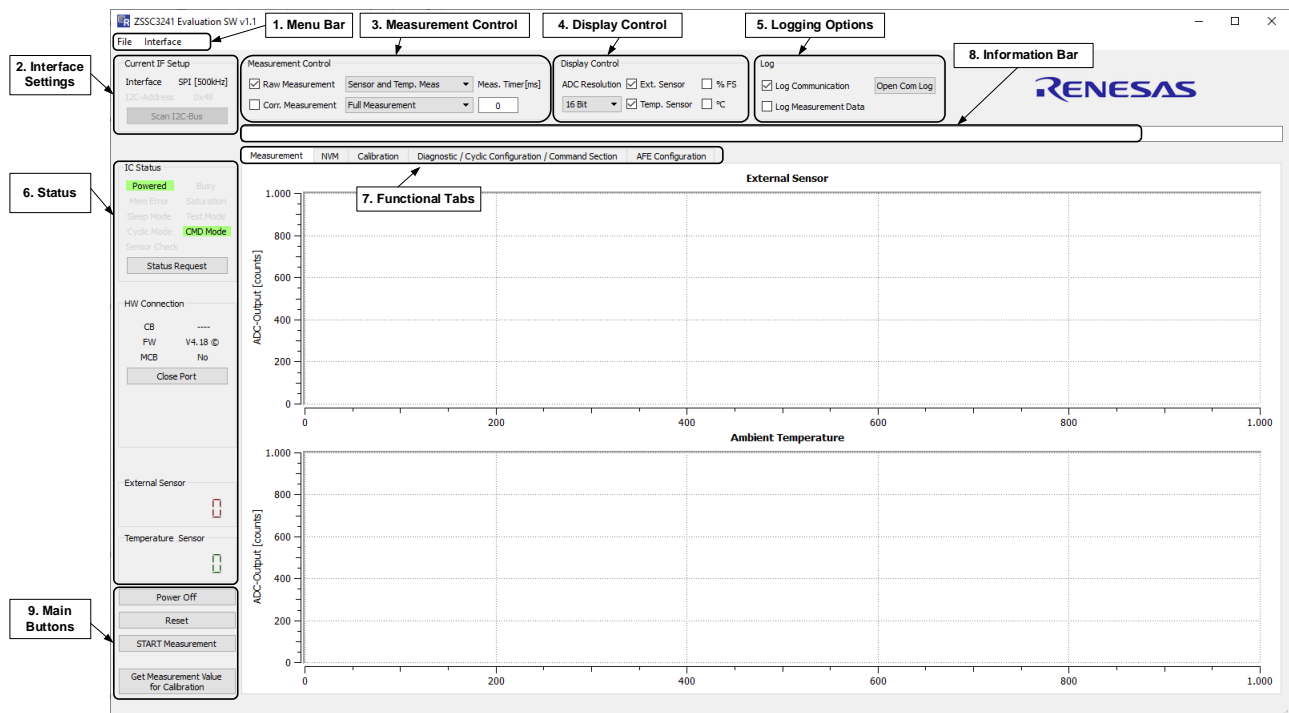

Figure 8. ZSSC3241 GUI Sections

2.1 Menu Bar

In this GUI section NVM configurations can be managed by loading/saving the full register content of the connected DUT. The detailed interface configuration setup can be entered and modified.

2.1.1. NVM Control

The content of the NVM can be saved and loaded via the corresponding *File* item. Changes in the NVM table of the GUI, such as manual input or recently loaded data, are not applicable until they are written into the registers of the ZSSC3241.

The ZSSC3241 NVM consists of two areas:

- Customer area: registers 0_{HEX} to 35_{HEX}
- Renesas area: registers 36_{HEX} to 3F_{HEX}

The configuration text files have the suffix 'nvm' for quick identification. They are containing the complete memory content, including the customer and the Renesas register information.

2.1.1.1. Load NVM Configuration

To load a configuration file, select *File / Load NVM Config*. Each row content (register value) is compared to the current value of the relevant register of the ZSSC3241 memory. If the compared values differ, the background of the NVM table row is displayed by red.

The configuration files contain the register information as decimal numbers. Once loaded in the GUI, these values are automatically displayed as hexadecimal values on the NVM tab.

2.1.1.2. Save NVM Configuration

To save a configuration file, select *File / Save NVM Config*. This menu item saves the latest content of the NVM to the chosen file. Each row of the NVM configuration file represents the content of one NVM 16-bit register value in decimal notation. Note that the file shows 64 NVM registers, but only the first 54 are accessible by the user.

Figure 9 shows an example for the first three lines of an NVM configuration. The first two registers are *Cust_ID0* and *Cust_ID1* having the default delivery value 0, the interface configuration (third row) register has a value of 72_{DEC} = 48_{HEX}.

Configuration files are saved by default into the directory of the GUI executable file. After a successful saving, the information bar displays a note with the full path to the saved file.

ZSSC3241_NVM_Config.nvm	
1	0
2	0
3	72

Figure 9. Extract of an NVM Configuration File

2.1.2. Interface Setup

Click on *Interface* (see Figure 10) and select I2C, SPI, or OWI for switching to use the relevant interface with standard settings.

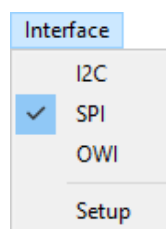
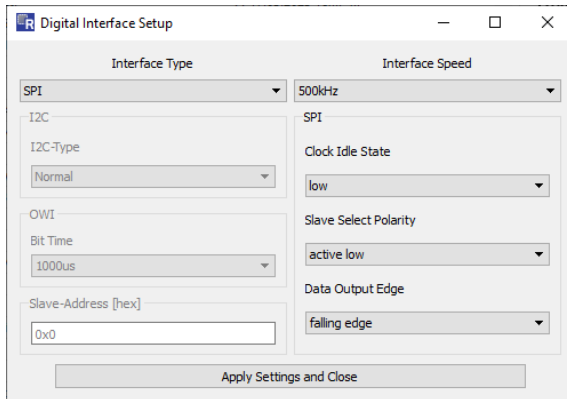

Figure 10. Interface Quick Selection

To change setting for an interface, follow these steps:

1. Click on *Interface / Setup*.
Digital Interface Setup pop-up window opens.
2. Select the communication protocol from the 'Interface Type' drop-down list.
3. Make the necessary changes to the configurable parameters, see Figure 11.
Due to limitations of the Communication Board the GUI does not allow the full bandwidth of settings supported by the ZSSC3241, for example, Fast and High Speed (HS) mode for I2C.



SPI communication is selected by default with a bus speed of 500kHz.

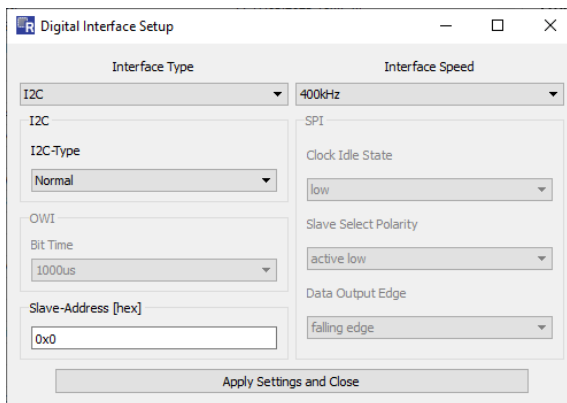

Setting I2C as interface the slave address can be entered manually. The 'Slave-Address [hex]' field displays the content of register 02_{HEX}, bits [6:0].

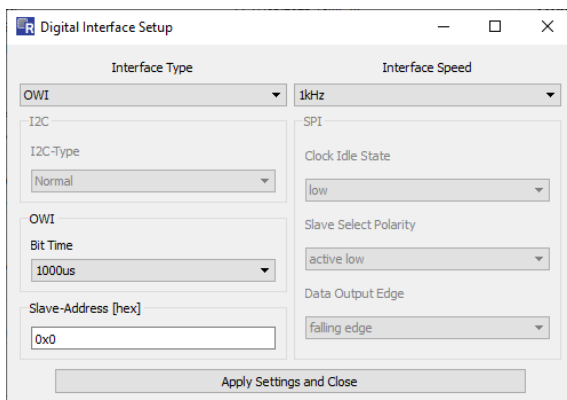

OWI speed is typically specified by the bit period (*Bit Time*). The *Interface Speed* drop-down also offers a speed configuration.

Figure 11. Communication Interface Configuration Options

4. Click on 'Apply Settings and Close' button.
The interface settings are taken over to the main GUI and Communication Board configuration.

2.2 Active Interface

The basic interface settings are summarized in this section. Additionally, there is an option to scan the I2C bus to identify the connected I2C slave. The *Scan I2C* bus button is only active when I2C communication is selected, as shown in Figure 12.

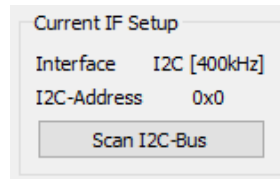

Figure 12. Interface Setting Display

Selecting *Scan I2C-Bus* triggers the sequence during which the ZSSC3241 status is requested for each address from 00_{HEX} to 7F_{HEX}. Once the connected slave-IC acknowledges the I2C address and provides a valid IC-status, the scan stops and the address is used for further communication. The scan result is displayed in the *Information Bar*:

- Status window message after a successful I2C scan: Valid I2C address found!
- Status window message after an I2C scan without slave acknowledging: No valid I2C address found!

2.3 Measurement Control

2.3.1. Measurement Commands

The GUI can send either a command for raw or for corrected measurement to the ZSSC3241 IC, depending on the selected checkbox.

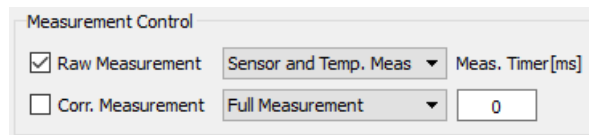

Figure 13. Measurement Control Section

The raw data output provides the results directly after the analog-to-digital conversion (ADC).

SSC corrected measurements return values after applying NVM coefficients to raw values. This measurement mode provides reasonable results only after a valid calibration of the ZSSC3241. The corrected data can be a result from a single measurement, or as an average of 2, 4, 8, or 16 consecutive samples.

The drop-down menu selection for SSC corrected output determines the number of measurements that are used for calculating the average result (see Figure 14).

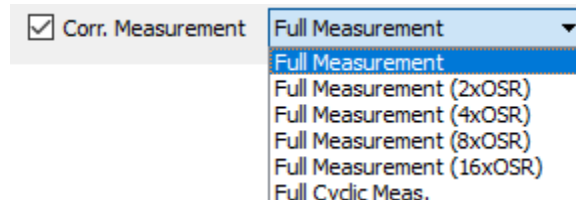

Figure 14. SSC-Measurement Command Choice

In the GUI the averaging option is assigned to the abbreviation OSR, which stands for “oversampling rate”. If ‘Full Cyclic Meas.’ is selected from the drop-down list in Cyclic Mode, the GUI applies only reading sequences on the bus for output data fetching, in order to periodically read the output registers. In Command and Sleep Modes, the Cyclic Mode is started first by the command AB_{HEX}. Thereafter, reading sequences are capturing the values from ZSSC3241’s output registers.

Note: In Cyclic Mode, the ZSSC3241 always provides BUSY=1 until the STOP_CYC (Command BF_{HEX}) command is sent.

In the drop-down menu it can be selected weather raw measurements are run for temperature measurements, external sensor or both (see Figure 15).

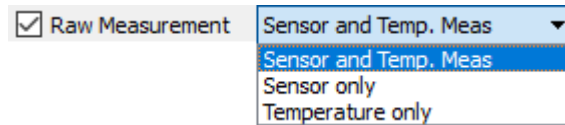

Figure 15. Raw Command Measurement Options

Regardless of the measurement type, a delay (in milliseconds) can be defined between the triggered measurements and the following reading sequence. The default value is 0ms, which allows the highest update rate, mainly limited by the USB timing.

2.4 Display Control

Settings in the display control section define how the measurement data is presented in the measurement tab and in the single numerical result display. It is possible to display either or both external and temperature sensor parameters. The ADC resolution can be adjusted for the presentation of measurement values. This does not affect the configured actual ADC resolution in the registers SM_config1 and SM_config2.

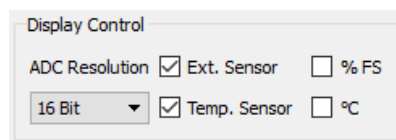

Figure 16. Measurements Display

Applying SSC conversion commands, it is possible to switch between x-bit LSB display and the FS (full scale) percentage output for the external sensor and degree Celsius for the temperature sensor (see exemplary display of the external sensor measurement results, in percent, in Figure 17)

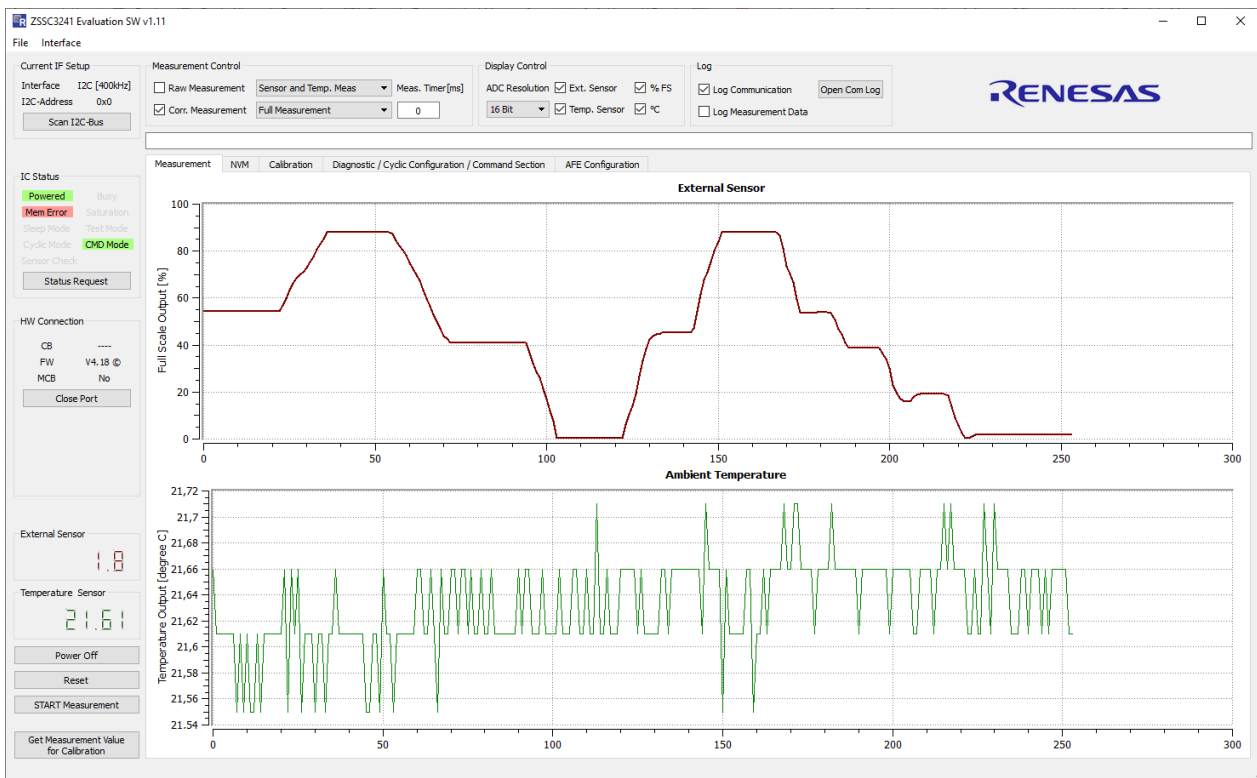

Figure 17. External Sensor Results Display in Percent

Each measurement result coming from the ZSSC3241 is structured in 3 bytes (24-bit). The GUI defines the data display by in the *Display Control* section. The full measurement data stream of bits can be considered in the communication log. Figure 18 gives an overview of the measurement ADC resolution context, depending on its processing step.

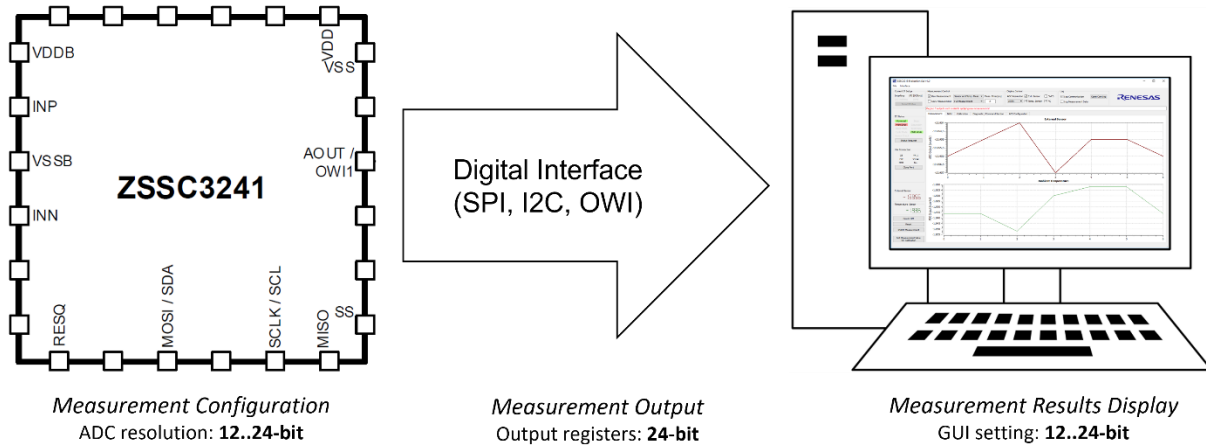

Figure 18. ADC Resolution from ZSSC3241 to GUI

2.5 Logging Options

The GUI offers two powerful logging options (see Figure 19):

- Log of the communication stream between the ZSSC3241 and the microcontroller on the Communication Board.
The communication log is always enabled. Clicking the 'Open Com Log' button opens the text file where the complete communication is stored from the last GUI launch.
 - Log of the measurements data from the ZSSC3241.
Click on the relevant checkbox enables the measurement data log. Clicking the 'Open Meas Log' button opens the csv file, where all measurement results are stored since the last enabling.
- Log files are stored in the same folder as the *ZSSC3241_Evaluation_SW_vX.XX.exe* file.

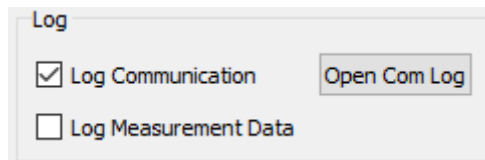

Figure 19. Logging Options

2.5.1. Communication Log

In Figure 20 examples of command logs for SPI, I2C, and OWI communication are shown.

```

send_spi: 'SW_008AA0000000000000' response: 'ACK'
receive_spi: 'SR_007' response: '441E26DF800000'
send_spi: 'SW_008AA0000000000000' response: 'ACK'
receive_spi: 'SR_007' response: '441E2702800000'

```

SPI

```

send_i2c: 'IW_48001AA' response: 'ACK'
receive_i2c: 'IR_48007' response: '441E3541800000'
send_i2c: 'IW_48001AA' response: 'ACK'
receive_i2c: 'IR_48007' response: '441E3541800000'

```

I2C

```

send_owi: 'OW_00001A2' response: 'ACK', ''
receive_owi: 'OR_00004' response: 'ACK', '40701D47'
send_owi: 'OW_00001A4' response: 'ACK', ''
receive_owi: 'OR_00004' response: 'ACK', '40F1BE00'

```

OWI

Figure 20. Communication Log Examples

2.5.2. Measurement Data Log

Measurement data can be recorded by activating the 'Log Measurements Data' checkbox in the *Log* section of the GUI (see Figure 19). While the 'Log Measurement Data' is checked all measurement results are appended to the log file. The data is logged in the same way as it is configured in the *Display Control*, see section 2.4.

2.6 Status

2.6.1. IC-Status

In the first byte of each reading sequence from the ZSSC3241 provides the operating status of the device. The meaning of single bits and bit combinations is decoded into *IC Status* section of the GUI (see Figure 21). Virtual LEDs and their labels are describing the electrical status, the actual ZSSC3241 mode, and the main self-diagnostic output of the ZSSC3241.

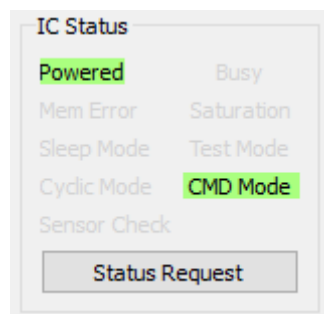

Figure 21. IC-Status Display

The status is updated automatically for any reading sequence from the ZSSC3241. It can also be updated manually by clicking on the 'Status Request' button. Table 10 shows various status indicators according to the relevant background color.

Table 10. IC-Status Indicators

Control	GUI	Virtual LED Indication
Powered	Powered	The ZSSC3241 is not powered correctly or no valid communication is present.
	Powered	The ZSSC3241 is powered correctly.
Busy	Busy	The ZSSC3241 device is not busy, new commands can be processed.
	Busy	The ZSSC3241 device is busy, which indicates that the ZSSC3241 is actively processing the last command. New commands are rejected.
Mem Error	Mem Error	The CRC (Cyclic Redundancy Check) successfully passed. The matches the calculated checksum of the actual NVM content.
	Mem Error	The CRC verification failed. The calculated CRC of the actual NVM does not match the CRC value in register 35 _{HEX} .
Saturation	Saturation	No saturation of the ALU. Intermediate and final results, applying coefficients on the raw measurement values within valid ranges.
	Saturation	Saturation occurred in the internal ALU.
Sleep Mode	Sleep Mode	The ZSSC3241 is not in Sleep Mode.
	Sleep Mode	The ZSSC3241 is in Sleep Mode.
Test Mode	Test Mode	The ZSSC3241 is not in Test Mode.
	Test Mode	The ZSSC3241 is in Test Mode (only for Renesas use).
Cyclic Mode	Cyclic Mode	The ZSSC3241 is not in Cyclic Mode.
	Cyclic Mode	The ZSSC3241 is in Cyclic Mode.
CMD Mode	CMD Mode	The ZSSC3241 is not in Command Mode.
	CMD Mode	The ZSSC3241 is in Command Mode and remains active and ready to receive dedicated commands.
Sensor Check	Sensor Check	No faults detected applying the self-diagnostic.
	Sensor Check	Configured self-diagnostic with fault detection.

2.6.2. Hardware Connection

This *HW Connection* section (see Figure 22) provides basic information regarding the detected Communication Board, the FW of the micro controller, and the Mass Calibration Board (MCB).

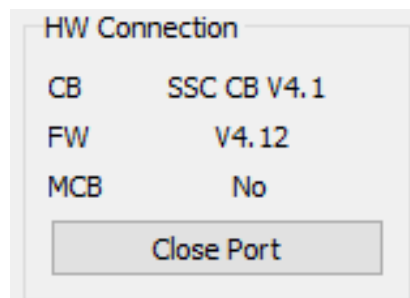

Figure 22. HW Connection Status

The 'Open Port / Close Port' button allows opening and closing the USB communication port. Closing the port is recommended for hardware changes (for example, switching the DUT or jumper settings, connecting MCB) without exiting the GUI.

2.6.3. Sensor and Temperature Readings

Sensor (external and temperature) readings from the ZSSC3241 are indicated in the numerical displays (see Figure 23). The displays show the recent measurement value in the decimal notation. As the measurement values in *Measurement* tab and measurement log, the output of the numerical displays is defined by the settings in the *Display Control* (see section 2.4).

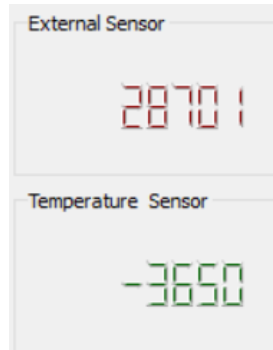

Figure 23. Numerical Display Measurement Results

2.7 Tabs

The primary GUI is partitioned into separate tabs, each of which is dedicated to a distinct functionality and/or a specific use case of the ZSSC3241. These tabs include measurement, non-volatile memory (NVM), calibration, diagnostic, and AFE (analog front-end) configuration.

2.7.1. Measurement Tab

The *Measurement* tab (see Figure 17) presents the data from the external and the temperature sensor in two separate graphs. Each graph is auto scaled according to the minimum and maximum value of the collected data. Up to 10000 measurements are represented on the screen. Every new measurement data after the initial 10000 clears the earliest data, therefore the displayed graph is made from the data of the last 10000 points maximum. Every time the 'START Measurements' button is clicked, the plots are cleared from previous data.

2.7.2. NVM Tab

The *NVM* tab shows the memory content by registers on the left side. On the right, the assigned configuration parameters are displayed.

2.7.2.1. NVM Table

The *NVM* tab is used to manage the memory data. The data is displayed in hexadecimal format for each of the first 35_{HEX} (53_{DEC}) registers in the NVM. The final register 35_{HEX} contains the checksum of the entire memory contents.

As shown in Figure 24, the first column is the address number; the second column is the description name for the corresponding register, the third column contains the registers data.

Register content changes are made by modifying the desired value directly in the table, or by using the drop-down menus of the single parameters.

Color-coding is used to identify different data states in the table:

- Red: Modified in the GUI (content is different from the last read value)
- Orange: Writing to ZSSC3241 memory failed
- Blue: Selected register

GUI changes in the NVM table are only effective after writing them to the ZSSC3241 memory and an IC reset. After a successful reprogramming of the NVM, the 'Mem Error' flag in the *IC Status* appears on a red

background, due to mismatch between the old CRC in register 35_{HEX} and changed data in the NVM. New CRC calculation can be triggered by clicking the 'Write CRC' button (see Figure 42).

On start-up, the GUI automatically attempts to read the memory content of the connected ZSSC3241. If it fails, the NVM tab displays the value 0_{HEX} for all registers. It is recommended to have the first memory data read of ZSSC3241 after the communication to the device is established.

The operations for reading and writing the NVM are controlled by the 'Write NVM' and 'Read NVM' buttons. The ZSSC3241 must be in Command Mode or Sleep Mode in order to write to the NVM.

Measurement	NVM	Calibration	Diagnostic / Cyclic Conf
Name	Value [hex]		
07	TCG_LSB	0000	
08	TCO_LSB	0000	
09	SOT_TCO_LSB	0000	
0A	SOT_TCG_LSB	0000	
0B	SOT_SENS_LSB	0000	
0C	OFFSET_T_LSB	0000	
0D	GAIN_T_LSB	0000	
0E	SOT_T_LSB	0000	
0F	OFFSET_S / GAIN_S_MSB	0040	
10	TCG / TCO_MSB	0000	
11	SOT_TCO / SOT_TCG_MSB	0000	
12	SOT_SENS / OFFSET_T_MSB	0000	
13	GAIN_T / SGT_T_MSB	2000	
14	SM_CONFIG 1	94E5	
15	SM_CONFIG 2	0205	
16	EXT_TEMP_CNFG 1	7412	
17	EXT_TEMP_CNFG 2	03CF	
18	TRSH_1A_LSB	0000	
19	TRSH_2A_LSB	0000	
1A	TRSH_2A / _1A_MSB	0000	
1B	SENS_SHIFT_LSB	0000	
1C	T_SHIFT_LSB	0000	
1D	SENS_SHIFT / T_SHIFT_MSB	0000	
1E	MEAS_SCHEDULER_1	0008	

Figure 24. NVM Table

2.7.2.2. Parameter View

On the right side of the NVM tab are the main functional parameters, decoded from NVM registers. Each parameter has a drop-down menu beside it, including all possible values or effects named by their meaning for configuration. Changing a parameter in its drop-down menu or in the NVM table shows directly the value change in the corresponding register. This register is then highlighted with the red background.

Figure 25 illustrates the assignment of the individual parameters to the respective registers.

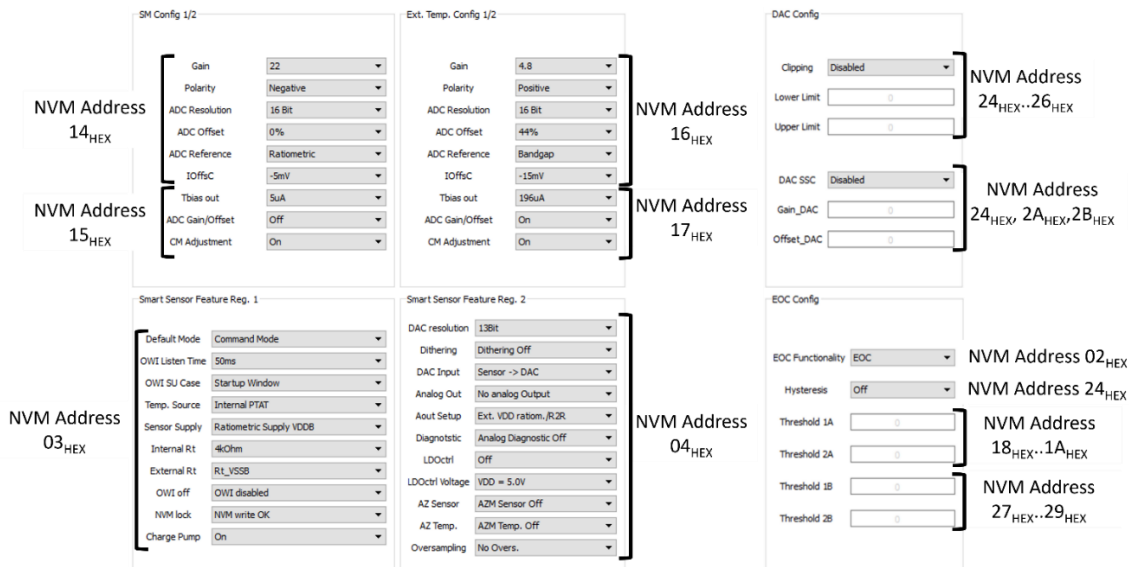

Figure 25. Parameter to Register Assignment

2.7.2.3. DAC Configuration

The analog output, controlled by the DAC, can be configured to clip at a defined lower and upper limit. Both can be entered as a decimal value, on the parameter side of this tab. The function is switched on and off via the 'Clipping' drop-down menu and the following NVM programming of the new state of the *clipping_on*-bit.

The 'DAC SSC' drop-down menu configures the use of DAC coefficients *Gain_DAC* and *Offset_DAC*. Whether these coefficients are necessary depends on the customer application (see Figure 29 for guidance). If needed, it is recommended to calculate their values in the *DAC SSC Calibration Section* of the GUI (see section 2.7.4.3).

For detailed information about the clipping function and the DAC SSC coefficients, refer to the ZSSC3241 *Datasheet* document.

2.7.2.4. EOC - Output Interrupt Signaling

Interrupt configuration of the EOC pin is available on the *NVM* tab. It can be configured for two different purposes, either as End-Of-Conversion signaling or as an interrupt output. With the EOC configuration $INT_setup = 00_{BIN}$, the EOC pulse is approximately 5µs long. After setting the *Threshold 1A/2B* values, the decimal inputs are converted into 16-bit values for the threshold interrupt registers 18_{HEX} , 19_{HEX} and $1A_{HEX}$ (see Figure 26), they are highlighted by a red background. To save the changes in the ZSSC3241's memory, click the 'Write NVM' button.

To use the hysteresis, its functionality has to be switch on in the 'Hysteresis' drop-down menu. For it the additional thresholds *Threshold 1B/2B* can be set in the same section. If hysteresis bit is not set to 'Off' the *Threshold 1B/2B* are greyed out, but still can be set and written to the NVM.

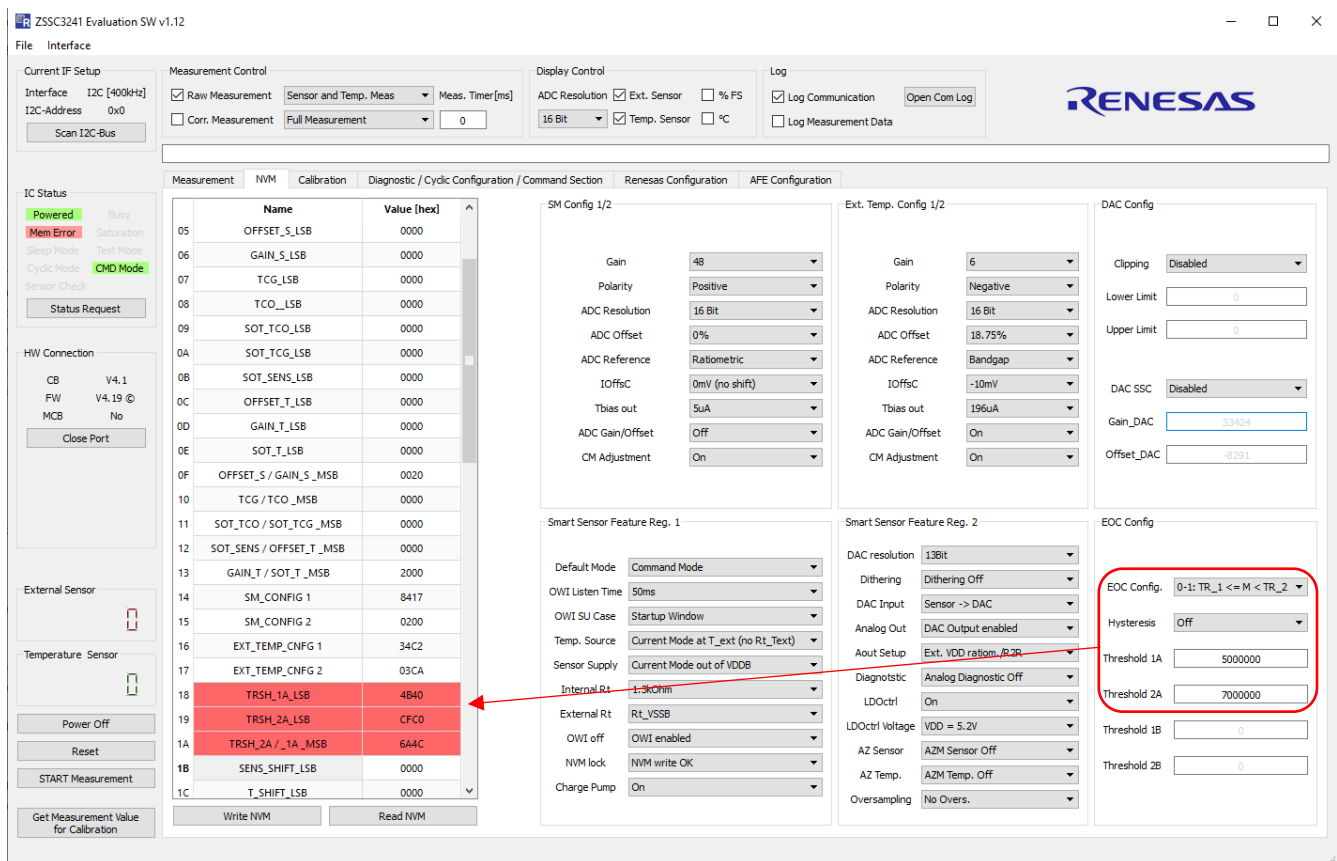

Figure 26. EOC Interrupt Thresholds

2.7.3. Calibration Tab

The *Calibration* tab (see Figure 27) allows the user to execute the calibration procedure for the external bridge sensor and/or the temperature sensor. The tab is divided into three main areas:

- Calibration Points Positions: distribution of the calibration points.
- Calibration Points: selection of the calibration type, see section 2.7.3.1.
- Coefficients: calculated calibration coefficients, see section 2.7.3.2.

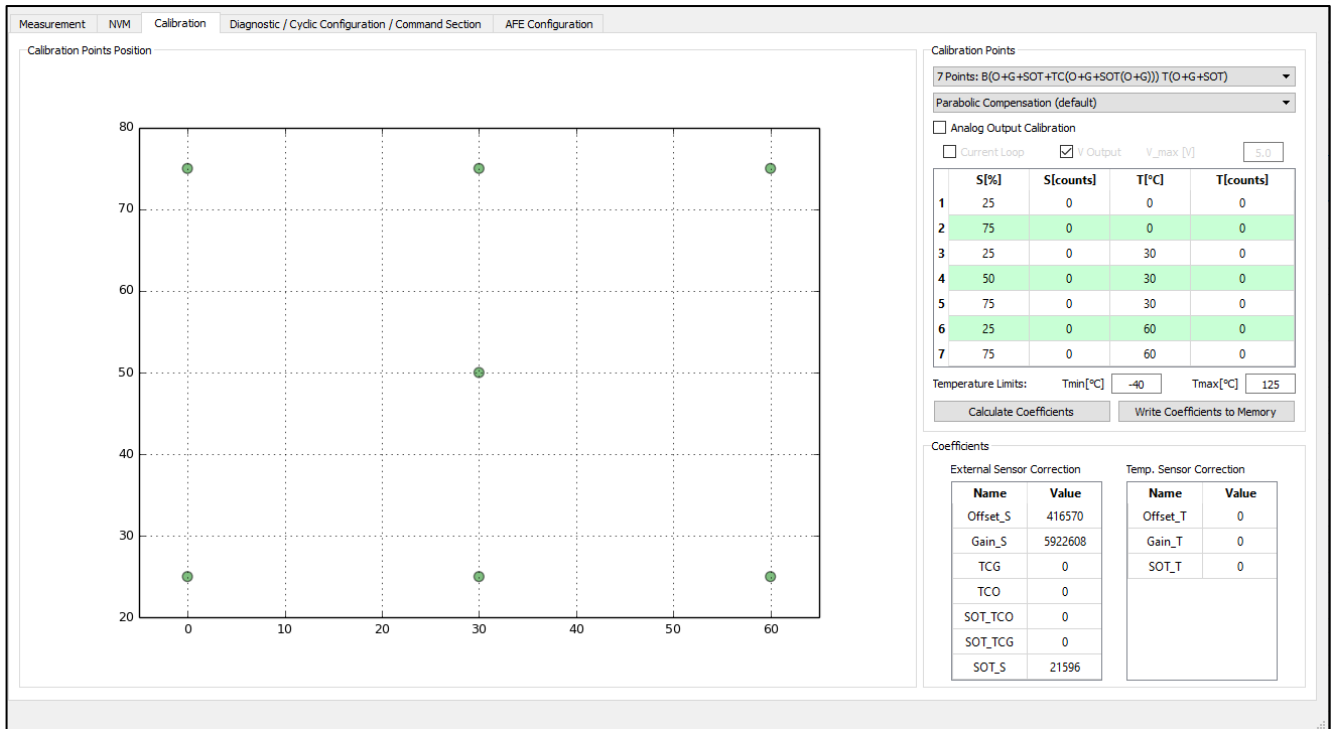

Figure 27. Calibration Tab

2.7.3.1. Calibration Points

The table of this section displays the calibration input where the calibration points are defined (raw measurement results with their reference information) for the external and temperature sensor, see Figure 27.

Follow these steps to calibrate the ZSSC3241 device:

1. Select the type of calibration from the upper drop-down list.
The calibration type is decisive for the corresponding number of calibration points, see Table 11 for default calibration types.

Table 11. Supported Default Calibration Types

Type	GUI	Calculated Coefficients									Required Set Points		
		OFFSET_S	GAIN_S	TCO	TCG	SOT_S	SOT_TCO	SOT_TCG	OFFSET_T	GAIN_T	SOT_T	External Sensor	Temperature
2 Point	S(O+G)	x	x									2	0
3 Point	S(O+G + SOT)	x	x			x						3	0
4 Point	S(O+G +TC(O+G) T(O+G))	x	x	x	x				x	x		2	2
5 Point	S(O+G +SOT + TC(O+SOT(O))) T(O+G+SOT))	x	x	x		x	x		x	x	x	3	3

Type	GUI	Calculated Coefficients										Required Set Points	
		OFFSET_S	GAIN_S	TCO	TCG	SOT_S	SOT_TCO	SOT_TCG	OFFSET_T	GAIN_T	SOT_T	External Sensor	Temperature
6 Point	$S(O+G+TC(O+G+SOT(O+G)))$ $T(O+G+SOT)$	x	x	x	x		x	x	x	x	x	3	2
7 Point	$S(O+G+SOT+TC(O+G+SOT(O+G)))$ $T(O+G+SOT)$	x	x	x	x	x	x	x	x	x	x	3	3
2 Point	$T(O+G)$								x	x		0	2
3 Point	$T(O+G+SOT)$								x	x	x	0	3

The number of entries in the table of this section is updated accordingly. It contains up to 7 rows and 4 columns for each combination of sensor and temperature conditions, see Table 12.

Table 12. Calibration Table Parameters

Parameter [Unit]	Description
S [counts]	Raw external sensor measurement result in counts.
S [%]	External sensor measurement reference point, entered as a percentage of the full measurement range after signal conditioning.
T [counts]	Raw temperature measurement result in counts.
T [°C]	Temperature measurement reference point. Enter this point in Celsius degrees.
AOUT [V] / [mA]	Optional analog measurement value, voltage or current, depending on the analog output configured.

The distribution of the reference values is also displayed in the *Calibration Points Position* graph to illustrate the coverage of the measurement range.

- Select the type of compensation from the lower drop-down list. Options to compensate the nonlinearity of the sensor data are Parabolic or S-Shape. Most sensor characteristics require the Parabolic compensation.
- Click the 'Get Measurement Value for Calibration' button (see section 2.9). Predefined values are displayed in the S[%] and T[°C] columns of the table with the result from the measurement.
- If needed, change the values for S[counts] and T[counts] by double clicking on them and entering the new value.

2.7.3.2. Coefficients

This section of the *Calibration* tab displays the coefficients after calculation. If one of the coefficients exceeds the range limits, its value appears as a red number. In this case, the status window displays "Calculated coefficients out of range!"

2.7.3.3. Analog Output Calibration

In addition to the standard calibration process, where raw data is inputted as digital values, the GUI has a feature that enables precise calibration of the analog output. For it the relevant analog measurement results must be used because the digital-to-analog converter and the analog output stage have a not ideal transfer function.

The overall nonlinearity can be covered in one calibration flow. When the focus is on analog output, it is recommended to enable the 'Analog Output Calibration' checkbox, as shown in Figure 28.

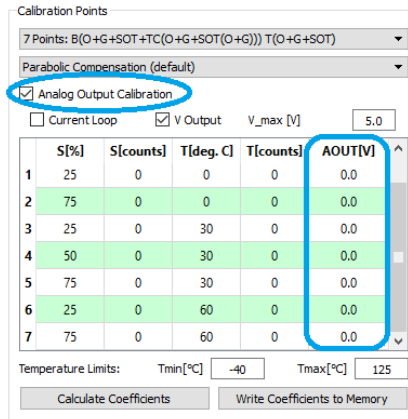

Figure 28. Activate Analog Calibration

Note: Raw measurement commands are not driving the analog output stage. To get the analog measurement values for the calibration table it is mandatory to use SSC commands in combination with default coefficients value in the NVM.

The analog output selection distinguishes generally between:

- Current Loop: The required jumper settings are shown in Table 7. The current loop application does not use the full dynamic range of the ADC, but the upper 75%, because the current range of 0mA to 4mA is reserved for the power supply of the ZSSC3241. Thus, its reference values in the first column differ from the digital input.
- Voltage Output: In this case the configured and/or measured voltage reference must be entered in the *Vmax[V]* window to achieve the highest accuracy possible

Depending on the application requirements, the analog output calibration can be established in the *DAC SSC Calibration* section in the *Diagnostic / Cyclic Configuration / Command Section* tab. The flow chart in Figure 29 is providing guidance for the right calibration choice.

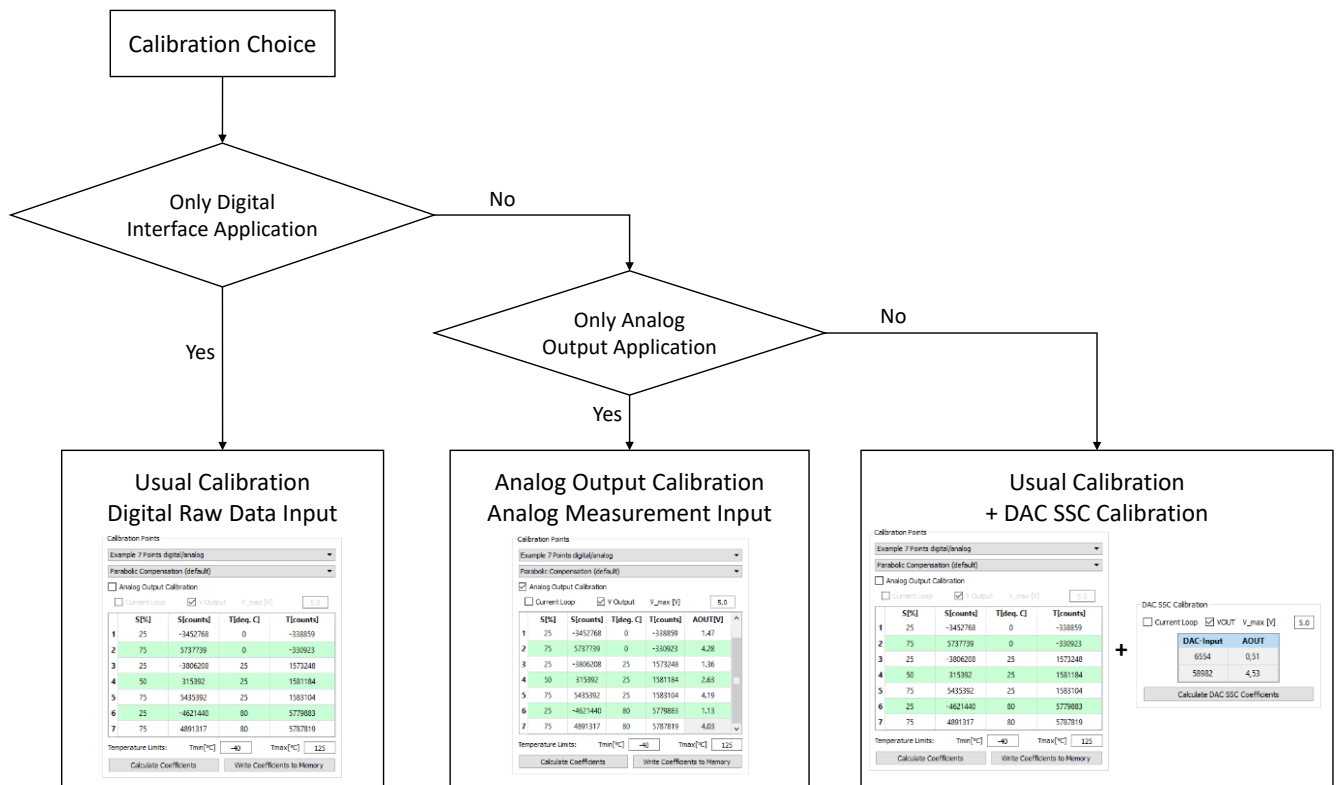

Figure 29. Calibration Choice Guidance

2.7.3.4. Calibration Examples

The calibration points drop-down menu contains at the lowest entries example calibration data for digital analog calibrations. Depending on user choice between voltage and current loop, the according raw data is updated in the calibration table. The coefficients are calculated by pressing the 'Calculate Coefficients' button.

See Figure 26 for an example where a raw bridge sensor value of -6727367 counts (24-bit resolution) mapped to 10% of FSO (Full Scale Output) by calibration, which results in a corrected digital output of 1677722 counts.

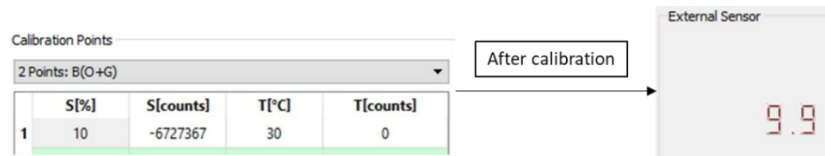

Figure 30. Raw Data to Calibrated Data in Percentage

2.7.4. Diagnostic / Cyclic Configuration / Command Section Tab

Figure 31 shows the eight sub-sections of the *Diagnostic / Cyclic Configuration / Command Section* tab.

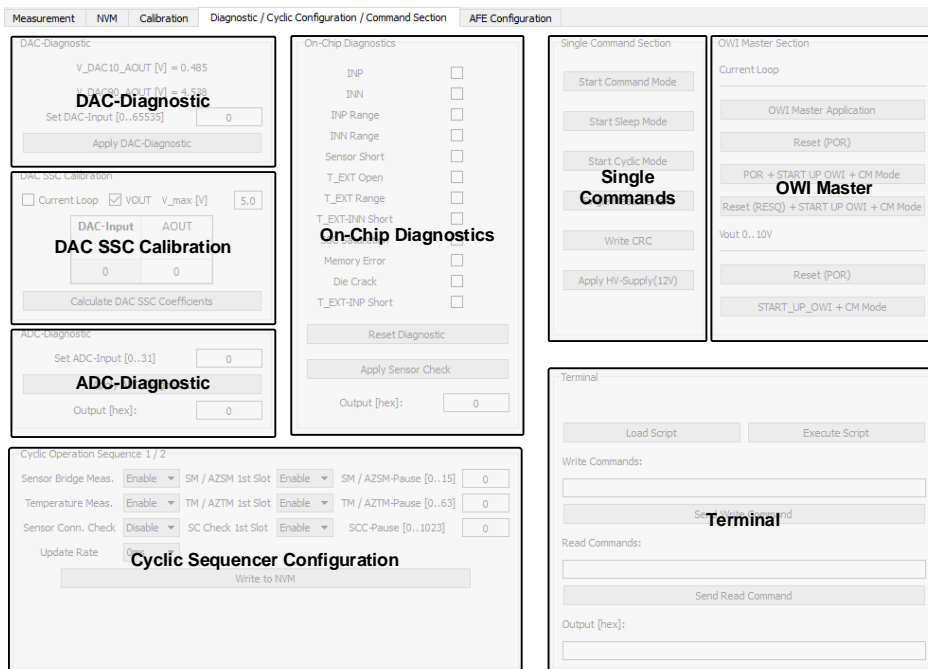

Figure 31. Diagnostic / Cyclic Configuration / Command Section Tab

2.7.4.1. DAC Diagnostic

The DAC module allows a direct digital value input to be set as the stimulus at the DAC. Clicking the 'Apply DAC-Diagnostic' button applies the set value to the DAC's input, updating its output. The output at the AOUT pin can be compared with the expected output based on its configuration.

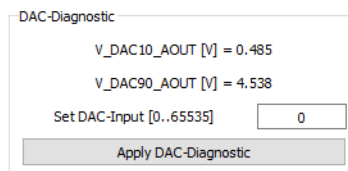

Figure 32. DAC-Diagnostic

This section shows the decoded measurement values for 10% and 90% excitation for the ratiometric configuration at the VDD = 5V. If this configuration is used for evaluation and/or application, these values can be used for the DAC SSC calibration. See section 2.7.4.3 for further details.

2.7.4.2. ADC Diagnostic

When the 'Apply ADC-Diagnostic' button is clicked to activate the ADC Diagnostic, the standard sensor processing path is disconnected. Instead, an analog differential voltage ranging from -15mV to +15mV is directly input to the ADC, which performs a conversion using the SM_config registers setup.

The input is realized via a decimal number from 0 to 31, which are directly mapped to the mV stages from -15mV to 15mV.

2.7.4.3. DAC SSC Calibration

This section is relevant for a separate analog output calibration when the usual calibration was already done and a digital interface is also used for measurements.



Figure 33. DAC SSC Calibration

Since the DAC SSC calibration results in two correction coefficients (Gain_DAC, Offset_DAC), the table for it has the following two lines for the calibration input:

- DAC-Input: a 16-bit number which drives the analog output according to its configuration.
- AOUT: the measured analog value.

Clicking on the 'Calculate DAC SSC Coefficients' button initiates the correction calculation process and displays the accurately converted outcomes in the *DAC Config* section of the *NVM* tab. The coefficients *Gain_DAC* and *Offset_DAC* can be saved to the NVM. Upon the next IC reset, they are utilized to modify the digital SSC measurement results prior to generating the analog output.

2.7.4.4. On-Chip Diagnostic

For possible sensor check(s) execution the relevant bits of NVM register 21_{HEX} must be set. The *On-Chip Diagnostics* section facilitates this process by activating the desired checks in the right checkbox. The function behind the 'Apply Sensor Check' button writes the correct value into the register 21_{HEX} and reads the results of the applied diagnostic. The results are displayed as the following background colors at each line of the triggered check:

- green: pass
- red: fail

The resulting 24-bit raw data is displayed additionally in the Output [hex] window.

If one of the chosen checks provides a fail, it is also signaled in the 'Sensor Check' bit of the general IC-Status Byte, which is presented on the left of the GUI (see Figure 34).



Figure 34. Diagnostic Result Example

2.7.4.5. Single Command Section

The buttons showed in this sub-section (see Figure 31) have the following functionalities:

- Start Command Mode: Command A9_{HEX}
- Start Sleep Mode: Command A8_{HEX}
- Start Cyclic Mode: Command AB_{HEX}
- Single Measurement: Command, as defined in the *Measurement Control* section.
- Write CRC: Command 39_{HEX}

It triggers the IC-internal CRC calculation over the current memory contents and writes it to register 35_{HEX}. It is the last step of the calibration process, after AFE configuration, coefficients calculation, and their writing to the NVM. After the checksum is written and the ZSSC3241 is reset, the *Memory Error* LED turns off (see Figure 21 and Table 10).

- Apply HV-Supply (12V)/Turn HV-Supply Off: Switches on/off the 12V supply from CB.
LED L3 is indicating whether this voltage is available on the EB (see Figure 3 and Table 4)

2.7.4.6. Terminal

Send commands directly to the ZSSC3241 on the *Terminal* section. For a reading command, the response is displayed in the output line. The *Terminal* is not relevant for evaluation; the purpose of this tool is having an option for a better debugging support.

Follow these steps for a write/read command:

1. Enter a command into the *Write Commands*: field.
2. Click the 'Send Write Command' button.
3. Enter a command into the *Read Commands*: field.
4. Click the 'Send Read Command' button.

The read data is provided in the *Output [hex]* field.

The command syntax can be found in the *SSC Command Syntax for V4.x Communication Boards* spreadsheet, which is available using the following link: [SSC-CB - SSC Communication Board | Renesas](#).

Figure 35 shows an example of Write/Read command.

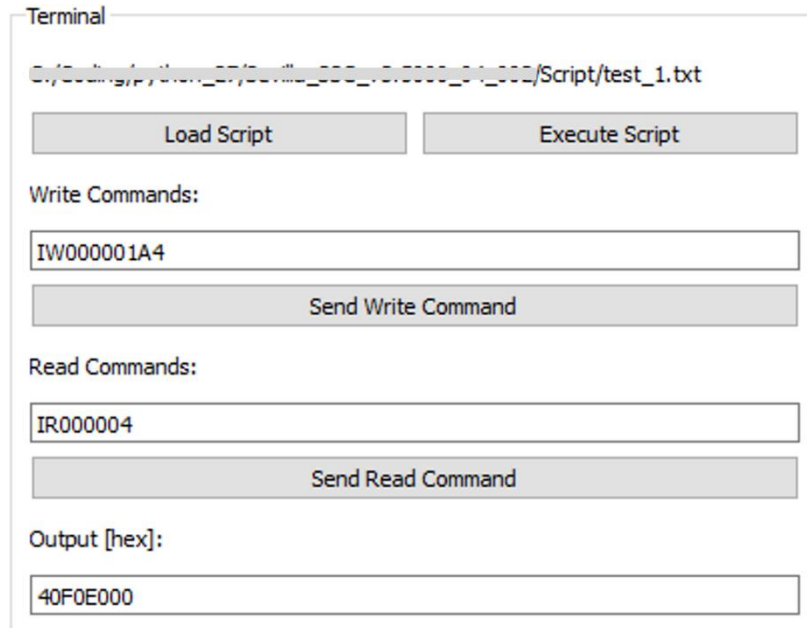

Figure 35. Read/Write Operations via Terminal

A script can be loaded and executed by clicking the ‘Loading Script’ button, see Figure 35. The GUI is limiting its search focus on text files with ‘.src’ extension. Any text file can be loaded, but each line of the script must contain a nonempty string.

2.7.4.7. Cyclic Sequencer Configuration

In Cyclic Mode the ZSSC3241 starts measuring autonomously after power-up. The continuously running measurement sequence consists of individual measurement slots in which all or a selectable subset of measurements and checks can be scheduled and allocated.

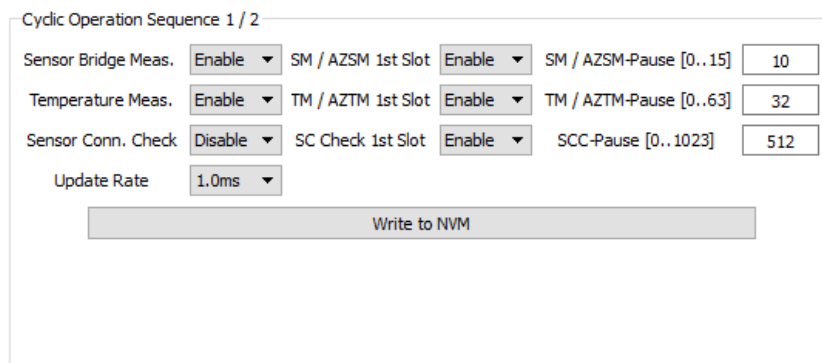

Figure 36. Cyclic Sequencer Section

Clicking the ‘Write to NVM’ button directly programs the configured settings into the registers for this purpose.

2.7.4.8. OWI Master Section

This functional block is relevant for Current Loop / voltage output evaluation, where the CB can be used as the master controller, responsible for supply voltage modulation and OWI communication.

2.7.5. AFE Configuration Tab

Figure 37 shows how the tab is divided into the following parts:

- AFE Configurator: allows the input of a general sensor characteristic, which is used to determine an optimized AFE Configuration. The resulting configuration can be directly transferred and written to the ZSSC3241 registers by clicking the 'Copy to SM_Config1' button.
- Raw Measurement Calculator (Sensor Signal <-> Digital Input): displays measurement results perception. The *AD Conversion Calculator* section shows how an analog sensor voltage is processed to a digital output, the *DA Conversion Calculator* section shows which digital output value is caused by a certain analog input.

Note: In both sections, the *SSC Output [counts]* is calculated with default coefficients settings.

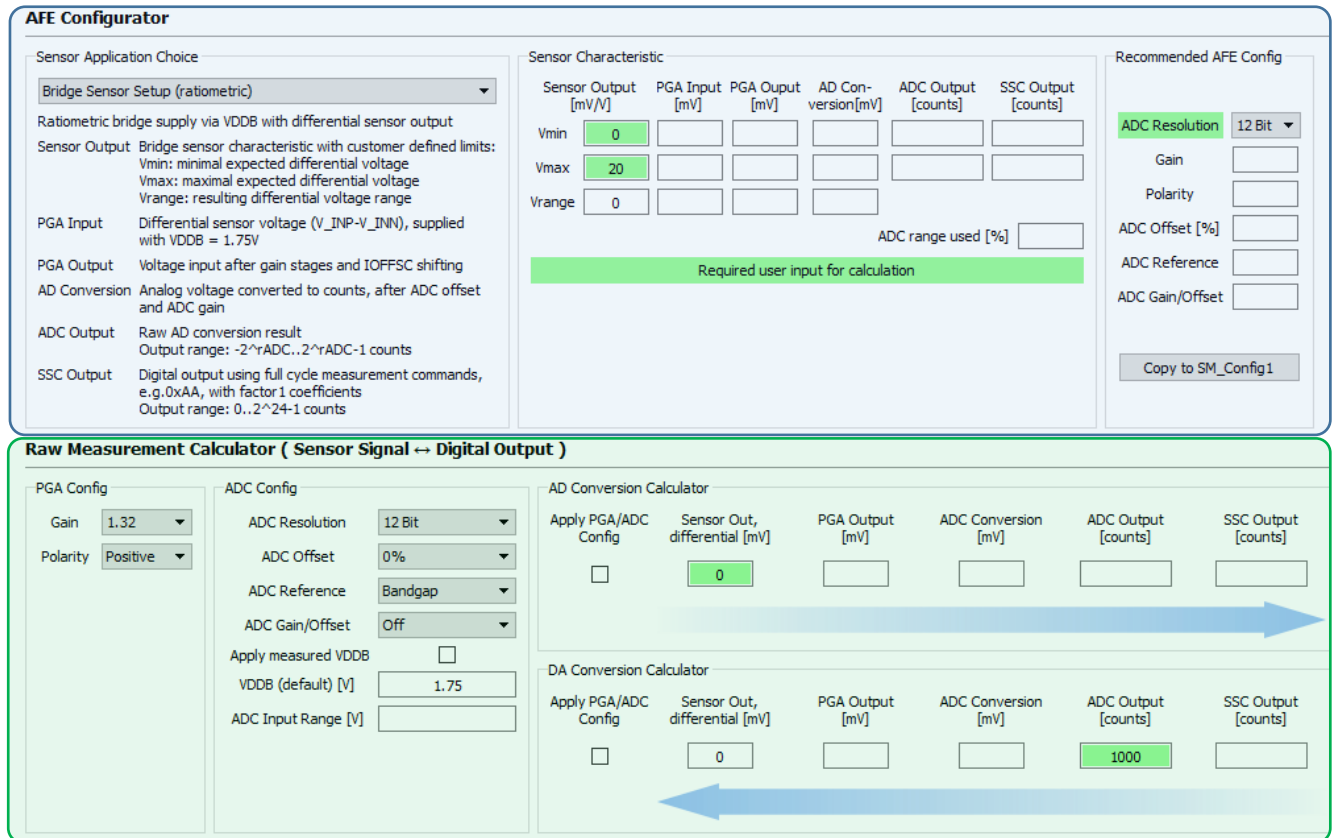

Figure 37. AFE Configuration Tab

2.7.5.1. AFE Configurator

The input for the configurator can be either the sensor characteristic or the desired application sensor range, and the output is an optimized AFE configuration. The necessary customer inputs are indicated by fields with a green background. *Vmin* and *Vmax* are the differential voltages that establish the bounds of the application.

Example:

The sensor characteristic displayed in Figure 38 is given. Assuming here that the complete array of curves should be covered by on optimized AFE configuration, then the according minimum and maximum sensor output can be read from the graph.

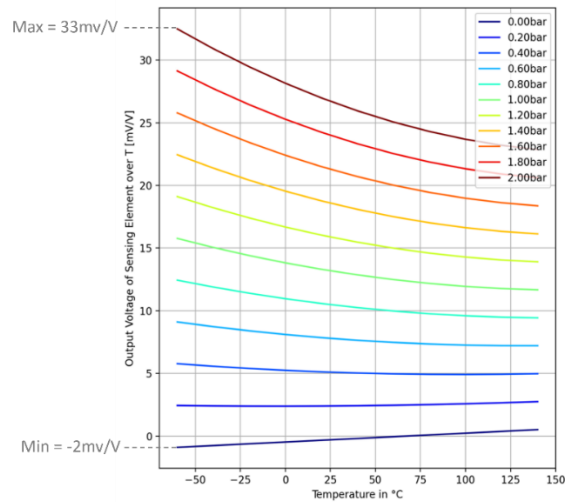

Figure 38. Sensor Characteristic

Since the min/max values have the unit mV/V already, they can be directly put into the *Sensor Output* windows. Figure 39 illustrates the calculation for this sensor example, the resulting configuration on the right side, and the effective usage of the ADC dynamic range below the calculated voltages in the processing chain.

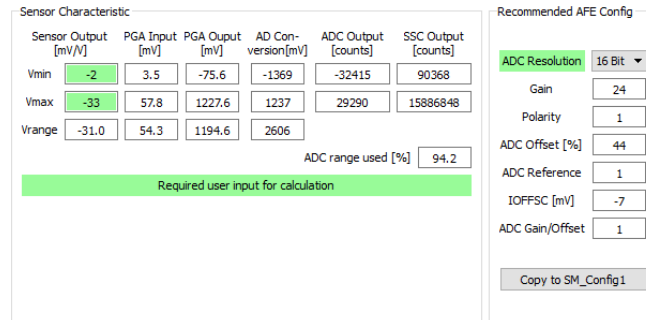

Figure 39. Example AFE Configurator Usage

The user could decide which other sensor characteristic range is relevant for the application and enter the appropriate values into the configurator. See Figure 41 for detailed explanation on sensor signal processing that shows how the interim results of the AFE configurator are assigned to the signal chain block diagram.

Before utilizing the AFE configurator tools, it is advised to properly configure the sensor application using the *Sensor Application Choice* section. The following measurement options are available in the drop-down list:

- Bridge Sensor Setup (ratiometric): ratiometric measurement of a differential sensor output (for example, resistive pressure sensors)
- Absolute-Voltage Sensor Setup: sensor output (for example, thermopile sensors)

By selecting an option, the relevant parameter specifications are shown (see Figure 40) with an overview of all parameters calculated in the *Sensor Characteristic* section (see Figure 39).

Depending on the sensor type there are the following differences in the parameter descriptions:

- The *Sensor Output* for bridge sensors with the ratiometric supply is specified in mV/V, while it is given in mV for absolute-voltage sensors. Since absolute-voltage sensors do not have any supply voltage, their output is also not depending on it.
- The *PGA Input* for ratiometric measurements is the sensor output adapted to the bridge supply of $V_{DDB} = 1.75V$ (for example, if the sensor output is specified with 10mV/V, the differential PGA input is $10mV/V \times 1.75V = 17.5mV$).

In case of absolute voltage sensors, the *PGA Input* is equal to the *Sensor Output*. The single ended sensor signal is referenced in the ZSSC3241 to the internal voltage of $V_{DDB}/2 = 0.875mV$.

Sensor Application Choice		Sensor Application Choice	
Bridge Sensor Setup (ratiometric)		Absolute-Voltage Sensor Setup	
Ratiometric bridge supply via VDDB with differential sensor output		Absolute voltage source (e.g. thermopile), INN connected to AGND=0.875V as reference to sensor provided voltage to INP	
Sensor Output	Bridge sensor characteristic with customer defined limits: Vmin: minimal expected differential voltage [mV/V] Vmax: maximal expected differential voltage [mV/V] Vrange: resulting differential voltage range [mV/V]	Sensor Output	Abs. sensor characteristic with customer defined limits: Vmin: minimal expected absolute voltage [mV] Vmax: maximal expected absolute voltage [mV] Vrange: resulting absolute voltage range [mV]
PGA Input	Differential voltage input (V_INP-V_INN) from resistive bridge sensor, supplied with VDDB = 1.75V	PGA Input	Same voltage as sensor output, since no VDDB applied. INN set to 0.875V IC-internal, for INP reference
PGA Output	Differential voltage after PGA gain and IOFFSC shifting	PGA Output	Differential voltage after PGA gain and IOFFSC shifting
AD Conversion	Analog voltage converted to counts, after ADC offset and ADC gain	AD Conversion	Analog voltage converted to counts, after ADC offset and ADC gain
ADC Output	Raw AD conversion result Output range: $-2^{rADC}..2^{rADC}-1$ counts	ADC Output	Raw AD conversion result Output range: $-2^{rADC}..2^{rADC}-1$ counts
SSC Output	Digital output using full cycle measurement commands, e.g. 0xAA, with factor1 coefficients Output range: $0..2^{24}-1$ counts	SSC Output	Digital output using full cycle measurement commands, e.g. 0xAA, with factor1 coefficients Output range: $0..2^{24}-1$ counts

Figure 40. Parameter Description Depending on Sensor Type

The sensor type choice implies a different IC-internal processing. Since the ZSSC3241 analog frontend is designed and optimized to process differential voltages, the input of the absolute voltage measurement must be referenced versus an internal voltage. This happens before the PGA (see Figure 41).

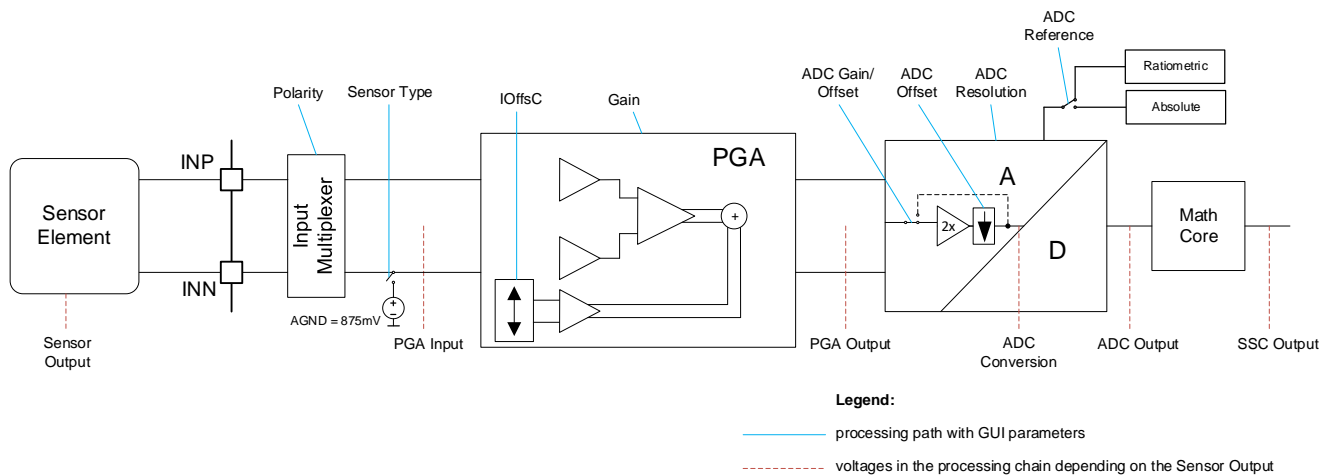

Figure 41. Sensor Signal Processing

2.7.5.2. Raw Measurement Calculator

The *Raw Measurement Calculator* consists of the following sections:

AD Conversion Calculator: converts a single sensor voltage to the raw digital output, depending on the adjustable configuration on the left side of it.

DA Conversion Calculator: realises the inverse function, where the raw digital input is transferred into the equivalent analog sensor output voltage. Both calculators can be enabled/disabled by the 'Apply PGA/ADC Config' checkboxes.

PGA Config		ADC Config		AD Conversion Calculator					
Gain	36	ADC Resolution	18 Bit	Apply PGA/ADC Config	Sensor Out, differential [mV]	PGA Output [mV]	ADC Conversion [mV]	ADC Output [counts]	SSC Output [counts]
Polarity	Positive	ADC Offset	0%	<input checked="" type="checkbox"/>	-3.5	-126.0	-126	-15437	7400640
		ADC Reference	Bandgap						
		ADC Gain/Offset	Off						
		Apply measured VDDB	<input type="checkbox"/>						
		VDDB (default) [V]	1.75						
		ADC Input Range [V]	1.07						
				DA Conversion Calculator					
				Apply PGA/ADC Config	Sensor Out, differential [mV]	PGA Output [mV]	ADC Conversion [mV]	ADC Output [counts]	SSC Output [counts]
				<input checked="" type="checkbox"/>	0.2	8.2	8	1000	8452608

Figure 42. Raw Measurement Calculator

2.8 Information Bar

The bar provides additional information for users, such as certain application status and warning messages. An example is shown in Figure 43, applying the I2C interface scan by the *Scan I2C-Bus* button.

Current IF Setup		Measurement Control		Display Control	
Interface	I2C [400kHz]	<input checked="" type="checkbox"/> Raw Measurement	Sensor and Temp. Meas	ADC Resolution	<input checked="" type="checkbox"/> Ext. Sensor
I2C-Address	0x0	<input type="checkbox"/> Corr. Measurement	Full Measurement	16 Bit	<input checked="" type="checkbox"/> Temp. Sensor
Scan I2C-Bus			Meas. Timer [ms]		<input type="checkbox"/> % FS
			0		<input type="checkbox"/> °C
Valid I2C-address found:0x0!					

Figure 43. Information Bar

2.9 Main Buttons

The most frequently used functions such as power on/off, reset, measuring, and raw data collection are grouped under the main buttons, in the bottom left corner of the GUI (see Figure 8):

- **Power On/Off:** Applies the supply voltage to the chip in the socket on the EB. The button label toggles according to the relevant status.
- **Reset:** Triggers a HIGH-LOW-HIGH-transition (active-low reset) at the RES pin. Clicking this button resets the ZSSC3241.
- **Start/Stop:** Trigger the start and stop of measurements acquisition. Its label toggles according to the relevant status.
- **Get Measurements Value for Calibration:** It is used in combination with the *Calibration* tab (see section 2.7.3).

3. Glossary

Term	Description
AD	Analog-to-Digital
ADC	Analog-to-Digital Converter
AFE	Analog Front End
ALU	Arithmetic Logic Unit
CB	Communication Board
CL	Current Loop
CMD	Command (received and processing)
COM	Communication Port
CRC	Cyclic Redundancy Check
DA	Digital-(to)-Analog
DC	Direct Current
DC/DC	DC-to-DC converter
DUT	Device Under Test
EB	Evaluation Board
EOC	End of Conversion
FET	Field-Effect Transistor
FS	Full-Scale
FSO	Full Scale Output (value in percent relative to the ADC maximum output code; resolution dependent)
FTDI	Future Technology Devices International
GND	Ground
GPIO	General-Purpose Input/Output
GUI	Graphical User Interface
HW	Hardware
I2C	Inter-Integrated Circuit bus
IC	Integrated Circuit
LSB	Least Significant Bit
MCB	Mass Calibration Board
MISO	Master In Slave Out (data output from slave)
MOSI	Master Out Slave In (data output from master)
NVM	Nonvolatile Memory
Op amp	Operating Amplifier
OSR	Oversampling Rate
OWI	One-Wire Interface
PC	Personal Computer
PGA	Programmable Gain Amplifier
POR	Power-On Reset
PQFN	Power Quad Flat No-lead
RC	Resistor-Capacitor
S	SSC-corrected Sensor Readout / Result
SCK	Serial Clock (output from master)
SCL	Serial Clock Line
SDA	Serial Data Line
SM	Sensor Measurement
SOT	Second Order Term
SPI	Serial Peripheral Interface
SRB	Sensor Replacement Board
SSC	Sensor Signal Conditioner
SSF	Smart-Sensor Function (specific NVM registers)
T	SSC-corrected (extra) Temperature Readout / Result
TC	Temperature Coefficient
USB	Universal Serial Bus
VDD	Supply Voltage (voltage supply for a drain terminal)
ZIF	Zero Insertion Force

4. Ordering Information

Orderable Part Number	Description and Package
ZSSC3241EVB	ZSSC3241 Evaluation Board
SSCCOMMBOARDV4P1C	SSC Communication Board V 4.1
SSCSENSORREPBDV2P0	SRB (Sensor Replacement Board) V2.0

5. Revision History

Revision Date	Description of Change
May.22.23	Initial release

Notice

1. Descriptions of circuits, software and other related information in this document are provided only to illustrate the operation of semiconductor products and application examples. You are fully responsible for the incorporation or any other use of the circuits, software, and information in the design of your product or system. Renesas Electronics disclaims any and all liability for any losses and damages incurred by you or third parties arising from the use of these circuits, software, or information.
2. Renesas Electronics hereby expressly disclaims any warranties against and liability for infringement or any other claims involving patents, copyrights, or other intellectual property rights of third parties, by or arising from the use of Renesas Electronics products or technical information described in this document, including but not limited to, the product data, drawings, charts, programs, algorithms, and application examples.
3. No license, express, implied or otherwise, is granted hereby under any patents, copyrights or other intellectual property rights of Renesas Electronics or others.
4. You shall be responsible for determining what licenses are required from any third parties, and obtaining such licenses for the lawful import, export, manufacture, sales, utilization, distribution or other disposal of any products incorporating Renesas Electronics products, if required.
5. You shall not alter, modify, copy, or reverse engineer any Renesas Electronics product, whether in whole or in part. Renesas Electronics disclaims any and all liability for any losses or damages incurred by you or third parties arising from such alteration, modification, copying or reverse engineering.
6. Renesas Electronics products are classified according to the following two quality grades: "Standard" and "High Quality". The intended applications for each Renesas Electronics product depends on the product's quality grade, as indicated below.
 - "Standard": Computers; office equipment; communications equipment; test and measurement equipment; audio and visual equipment; home electronic appliances; machine tools; personal electronic equipment; industrial robots; etc.
 - "High Quality": Transportation equipment (automobiles, trains, ships, etc.); traffic control (traffic lights); large-scale communication equipment; key financial terminal systems; safety control equipment; etc.
- Unless expressly designated as a high reliability product or a product for harsh environments in a Renesas Electronics data sheet or other Renesas Electronics document, Renesas Electronics products are not intended or authorized for use in products or systems that may pose a direct threat to human life or bodily injury (artificial life support devices or systems; surgical implantations; etc.), or may cause serious property damage (space system; undersea repeaters; nuclear power control systems; aircraft control systems; key plant systems; military equipment; etc.). Renesas Electronics disclaims any and all liability for any damages or losses incurred by you or any third parties arising from the use of any Renesas Electronics product that is inconsistent with any Renesas Electronics data sheet, user's manual or other Renesas Electronics document.
7. No semiconductor product is absolutely secure. Notwithstanding any security measures or features that may be implemented in Renesas Electronics hardware or software products, Renesas Electronics shall have absolutely no liability arising out of any vulnerability or security breach, including but not limited to any unauthorized access to or use of a Renesas Electronics product or a system that uses a Renesas Electronics product. RENESAS ELECTRONICS DOES NOT WARRANT OR GUARANTEE THAT RENESAS ELECTRONICS PRODUCTS, OR ANY SYSTEMS CREATED USING RENESAS ELECTRONICS PRODUCTS WILL BE INVULNERABLE OR FREE FROM CORRUPTION, ATTACK, VIRUSES, INTERFERENCE, HACKING, DATA LOSS OR THEFT, OR OTHER SECURITY INTRUSION ("Vulnerability Issues"). RENESAS ELECTRONICS DISCLAIMS ANY AND ALL RESPONSIBILITY OR LIABILITY ARISING FROM OR RELATED TO ANY VULNERABILITY ISSUES. FURTHERMORE, TO THE EXTENT PERMITTED BY APPLICABLE LAW, RENESAS ELECTRONICS DISCLAIMS ANY AND ALL WARRANTIES, EXPRESS OR IMPLIED, WITH RESPECT TO THIS DOCUMENT AND ANY RELATED OR ACCOMPANYING SOFTWARE OR HARDWARE, INCLUDING BUT NOT LIMITED TO THE IMPLIED WARRANTIES OF MERCHANTABILITY, OR FITNESS FOR A PARTICULAR PURPOSE.
8. When using Renesas Electronics products, refer to the latest product information (data sheets, user's manuals, application notes, "General Notes for Handling and Using Semiconductor Devices" in the reliability handbook, etc.), and ensure that usage conditions are within the ranges specified by Renesas Electronics with respect to maximum ratings, operating power supply voltage range, heat dissipation characteristics, installation, etc. Renesas Electronics disclaims any and all liability for any malfunctions, failure or accident arising out of the use of Renesas Electronics products outside of such specified ranges.
9. Although Renesas Electronics endeavors to improve the quality and reliability of Renesas Electronics products, semiconductor products have specific characteristics, such as the occurrence of failure at a certain rate and malfunctions under certain use conditions. Unless designated as a high reliability product or a product for harsh environments in a Renesas Electronics data sheet or other Renesas Electronics document, Renesas Electronics products are not subject to radiation resistance design. You are responsible for implementing safety measures to guard against the possibility of bodily injury, injury or damage caused by fire, and/or danger to the public in the event of a failure or malfunction of Renesas Electronics products, such as safety design for hardware and software, including but not limited to redundancy, fire control and malfunction prevention, appropriate treatment for aging degradation or any other appropriate measures. Because the evaluation of microcomputer software alone is very difficult and impractical, you are responsible for evaluating the safety of the final products or systems manufactured by you.
10. Please contact a Renesas Electronics sales office for details as to environmental matters such as the environmental compatibility of each Renesas Electronics product. You are responsible for carefully and sufficiently investigating applicable laws and regulations that regulate the inclusion or use of controlled substances, including without limitation, the EU RoHS Directive, and using Renesas Electronics products in compliance with all these applicable laws and regulations. Renesas Electronics disclaims any and all liability for damages or losses occurring as a result of your noncompliance with applicable laws and regulations.
11. Renesas Electronics products and technologies shall not be used for or incorporated into any products or systems whose manufacture, use, or sale is prohibited under any applicable domestic or foreign laws or regulations. You shall comply with any applicable export control laws and regulations promulgated and administered by the governments of any countries asserting jurisdiction over the parties or transactions.
12. It is the responsibility of the buyer or distributor of Renesas Electronics products, or any other party who distributes, disposes of, or otherwise sells or transfers the product to a third party, to notify such third party in advance of the contents and conditions set forth in this document.
13. This document shall not be reprinted, reproduced or duplicated in any form, in whole or in part, without prior written consent of Renesas Electronics.
14. Please contact a Renesas Electronics sales office if you have any questions regarding the information contained in this document or Renesas Electronics products.

(Note1) "Renesas Electronics" as used in this document means Renesas Electronics Corporation and also includes its directly or indirectly controlled subsidiaries.

(Note2) "Renesas Electronics product(s)" means any product developed or manufactured by or for Renesas Electronics.

(Disclaimer Rev.5.0-1 October 2020)

Corporate Headquarters

TOYOSU FORESIA, 3-2-24 Toyosu,
Koto-ku, Tokyo 135-0061, Japan
www.renesas.com

Trademarks

Renesas and the Renesas logo are trademarks of Renesas Electronics Corporation. All trademarks and registered trademarks are the property of their respective owners.

Contact Information

For further information on a product, technology, the most up-to-date version of a document, or your nearest sales office, please visit:
www.renesas.com/contact/