

RC2121xA (AutoClock)

Evaluation Board

The RC2121xA (RC21211A, RC21212A, RC21213A, RC21214A [AutoClock™]) Evaluation Board (EVB) is designed to support users evaluating the clock generation in synthesizer mode for PCIe Gen compliance and commercial automotive applications.

Specifications

- 169fs RMS phase jitter (10kHz–20MHz, 156.25MHz).
- PCIe Gen6 Common Clock (CC) 27fs RMS

Board Contents

Items shipped with EVB kit:

- EVB
- USB cable

Features

- PCIe SRIS and SRNS support
- 1kHz to 650MHz (differential) and 1kHz to 200MHz (single-ended) outputs
- LVCMOS, LVDS or Low-Power HCSL output types with simple AC-coupling to LVPECL and CML. LP-HCSL integrates terminations.
- Seven programmable general-purpose input/outputs (GPIO)
- 1MHz I²C serial port
- Multiple configurations can be stored in internal One-Time Programmable (OTP) memory.
- 1.8V or 3.3V operation
- Crystal or crystal overdrive (REFIN) via SMA
- Available sense lines on crystal overdrive.
- Test points on Outputs for Hi-Z probes.
- Jumper selectable voltage setting for 3.3V/2.5V/1.8V powered from USB

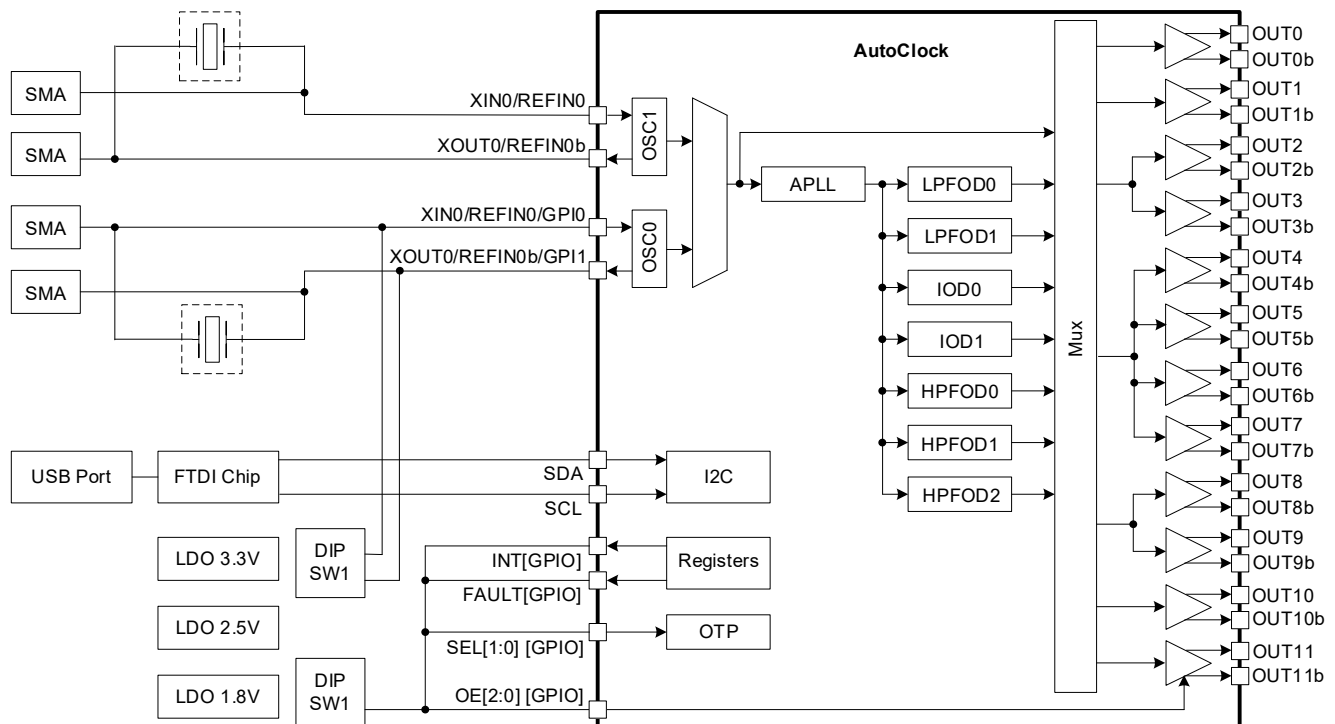

Figure 1. Board Block Diagram

Contents

1. Functional Description	4
1.1 Operational Characteristics	4
1.2 Setup and Configuration	4
1.2.1 RC21211/RC21212 vs RC21213/RC21214	4
1.2.2 On Board Crystal PAD and Reference Input	10
1.2.3 Serial Connection	11
1.2.4 GPI/GPIO DIP Switch Selectors	12
1.2.5 Outputs	13
1.2.6 Power and USB connection to Computer Host	13
1.2.7 Renesas Integrated Circuit Toolbox (RICBox)	14
1.2.8 Programming an RC2121xA Device using RICBox Software	14
2. Evaluation Board Components	18
2.1 Layout Guidelines	18
2.1.1 ePAD	18
2.1.2 Crystal/Reference Input	19
2.1.3 Serial Connection	20
2.1.4 GPI/GPIO	20
2.1.5 Outputs	20
2.1.6 Power	20
2.2 Schematic Diagrams	20
2.2.1 Schematics for 40-Pin VFQFPN	20
2.2.2 Schematics for 48-Pin VFQFPN	20
2.3 Board Layout	21
3. Quick Start Guide	31
4. Ordering Information	31
5. Revision History	31

Figures

Figure 1. Board Block Diagram	1
Figure 2. RC21213/RC21214 AutoClock Evaluation Board	5
Figure 3. RC21211/RC21212 AutoClock Evaluation Board	8
Figure 4. Crystal Footprints	10
Figure 5. Single-ended Differential Ref Input	10
Figure 6. Communication Setup for I ² C Mode	11
Figure 7. Aardvark Adapter Connection to J65	11
Figure 8. DIP Switch SW1	12
Figure 9. DIP Switch SW2	12
Figure 10. Output Termination with SMA Connector	13
Figure 11. Output Termination with Bias Schematic	13
Figure 12. Power Source from USB Connector	14
Figure 13. Power Source Selection	14
Figure 14. RICBox Start Page	14

Figure 15. Select Product Family and Variant	15
Figure 16. Inputs Wizard Page	15
Figure 17. Outputs Wizard Page	16
Figure 18. Advanced Output Settings.....	16
Figure 19. Configuration Summary.....	17
Figure 20. Connect to AutoClock.....	17
Figure 21. Program AutoClock	17
Figure 22. Block Diagram	18
Figure 23. PCB Assembly for Exposed Pad Thermal Release Path – Side View.....	19
Figure 24. Power Supply Filtering.....	20
Figure 25. Layer 1 – Top	21
Figure 26. Layer 2 – Signal	22
Figure 27. Layer 3 – Clock Signals.....	23
Figure 28. Layer 4 – GND Plane	24
Figure 29. Layer 5 – Power Plane	25
Figure 30. Layer 6 – Power Plane	26
Figure 31. Layer 7 – Ground Plane	27
Figure 32. Layer 8 – Signal	28
Figure 33. Layer 9 – Ground Plane	29
Figure 34. Layer 10 – Bottom.....	30

Tables

Table 1. Summary of RC21211/RC21212 and RC21213/RC21214.....	4
Table 2. RC21213A/RC21214A EVB Pins and Functions.....	5
Table 3. RC21211A/RC21212A – EVB Pins and Functions.....	8
Table 4. SW1 Description.....	12
Table 5. SW2 Description.....	12
Table 6. Thermal Characteristics (40-pin)	19
Table 7 Thermal Characteristics (48-pin)	19

1. Functional Description

The RC2121xA Evaluation Board (EVB) is designed to support users evaluating the RC21211, RC21212A, RC21213A and RC21214A devices using clock generation in synthesizer mode for PCIe Gen compliance. When the EVB is connected via USB to the user's computer running Renesas Integrated Circuit Toolbox ([RICBox™](#)) software, RC2121xA devices can be configured in various frequencies with best-in-class commercial performance. The devices offer various features with eight to twelve pairs of differential outputs. Each pair of output can be programmed to LVCMOS, LVDS, and LP-HCSL style outputs. There are seven general purpose input/output (GPIOs) and two general purpose input (GPIs) to support output enables, configuration selection, and status outputs. Voltage levels for VDDX0, VDDX1, VDDA, VDDD, and VDDO0–6 can be set by jumpers.

1.1 Operational Characteristics

The EVB is capable of functioning in temperature range of -40°C to +105°C and is capable of operating in VDD values of 3.3V, and 1.8V. The VDD_J banana connection can be used to set any desired voltage within the range of 1.71V to 3.63V. RC2121xA devices are ISO9001 compliant, AEC-Q100 qualified, and provides support for PPAP.

1.2 Setup and Configuration

The following sections explain the Crystal/Ref input clock, Serial, GPI/GPIO, and output and power functions used for setting up and configuring the devices using RICBox software.

1.2.1 RC21211/RC21212 vs RC21213/RC21214

The RC21211/RC21212 are twelve differential pair output devices, while the RC21213/RC21214 are eight differential pair output devices. The RC21211/RC21213 devices has single crystal/reference input, whereas the RC21212/RC21214 has two crystal/reference inputs.

The following table summarizes the differences between the devices.

Table 1. Summary of RC21211/RC21212 and RC21213/RC21214

Device	Number of Crystal Inputs	GPIO	GPI	Output Clocks
RC21211A	Single	GPIO0 – GPIO6	GPI0, GPI1	OUT0 – OUT11
RC21212A	Dual	GPIO0 – GPIO6	-	OUT0 – OUT11
RC21213A	Single	GPIO0 – GPIO6	GPI0, GPI1	OUT1, OUT2, OUT3, OUT6, OUT7, OUT8, OUT10, OUT11
RC21214A	Dual	GPIO0 – GPIO6	-	OUT1, OUT2, OUT3, OUT6, OUT7, OUT8, OUT10, OUT11

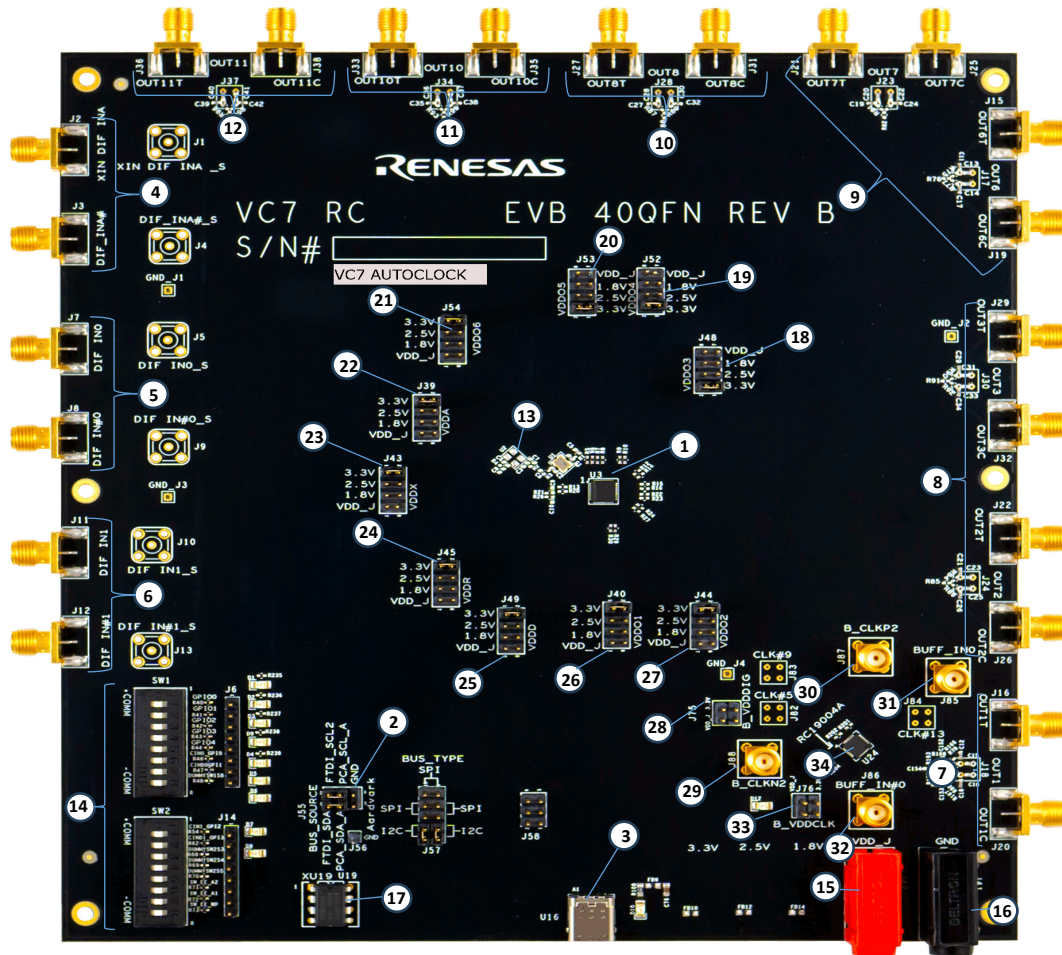

Figure 2. RC21213/RC21214 AutoClock Evaluation Board

Refer to Table 2 for the RC21213A/RC21214A evaluation board pin descriptions and functions.

Table 2. RC21213A/RC21214A EVB Pins and Functions

Item	Name	On-Board Connector Label	Function
1	RC21213/RC21214	U3	Evaluation device, 5 × 5 × 0.75 mm 40-pin VFQFPN.
2	I ² C for FTDI or Aardvark Connector	J55	6-pin header of I ² C connector for SCL and SDA pins.
3	USB Interface	U16	USB type jack for connection with the computer and interaction with RICBox software.
4	XIN0 / XOUT0 REFIN0/ REFIN0B	J2, J3	Differential REF clock input positive on J2 and negative on J3. If J2 is connected to XIN as REFIN single-ended, J3 must be left unconnected.
5	XIN1 / XOUT1 REFIN0 / REFIN1B GPIO / GPI1	J7, J8	For RC21214 differential REF clock input positive on J8 and negative on J7. For CMOS single-ended reference clock input J8 is connected to XIN as REFIN single-ended, J7 must be left unconnected. For single crystal variant this pin act as GPIO and GPI1 SMA Connector.

Item	Name	On-Board Connector Label	Function
6	GPIO5, GPIO6	J11, J12	GPIO5 and GPIO6 SMA Connector
7	Test Points for OUT1	J16, J20	SMA connectors for differential outputs using VDDO1 power rail (populated with a pair of SMA connector): J16, J20 for OUT1
8	Test Points for OUT2, OUT3	J22, J26, J29, J32	SMA connectors for differential outputs using VDDO2 power rail (populated with a pair of SMA connector): J22, J26 for OUT2 J29, J32 for OUT3
9	Test Points for OUT6, OUT7	J15, J19, J21, J25	SMA connectors for differential outputs using VDDO3 power rail (populated with a pair of SMA connector): J15, J19 for OUT6 J21, J25 for OUT7
10	Test Points for OUT8	J27, J31	SMA connectors for differential outputs using VDDO4 power rail (populated with a pair of SMA connector): J27, J31 for OUT8
11	Test Points for OUT10	J33, J35	SMA connectors for differential outputs using VDDO5 power rail (populated with a pair of SMA connector): J33, J35 for OUT10
12	Test Points for OUT11	J36, J38	SMA connectors for differential outputs using VDDO6 power rail (populated with a pair of SMA connector): J36, J38 for OUT11
13	Crystal Pads	U1, U2	To mount different quartz crystals.
14	DIP Switches	SW1, SW2	DIP switch devices are used to setup GPIO/GPI pins based on RC21213/RC21214 device condition. For details, see Figure 8 and Figure 9.
15	Power VDD Jack	J42	External power supply, positive terminal. Apply 3.3V or 1.8V as default only.
16	Power GND Jack	J41	External power supply, negative terminal, or ground.
17	EEPROM IC	XU19, U19	An external EEPROM IC and an 8-lead PDIP8 socket. Populated with AT24C04C 4-Kbit (512 × 58) EEPROM as default.
18	VDDO3	J48	Power source selector. Select in 3.3V, 1.8V or external power VDD_J for OUT Bank 3.
19	VDDO4	J52	Power source selector. Select in 3.3V, 1.8V or external power VDD_J for OUT Bank 4.
20	VDDO5	J53	Power source selector, select in 3.3V, 1.8V or external power VDD_J for OUT Bank 5.
21	VDDO6	J54	Power source selector. Select in 3.3V, 1.8V or external power VDD_J for OUT Bank 6.
22	VDDA	J39	Power source selector. Select in 3.3V, 1.8V or external power VDD_J for analog circuit power.
23	VDDX	J43	Power source selector. Select in 3.3V, 1.8V or external power VDD_J for crystal circuit power.

Item	Name	On-Board Connector Label	Function
24	VDDR	J45	Power source selector. Select in 3.3V, 1.8V or external power VDD_J for reference input circuit power.
25	VDDD	J49	Power source selector. Select in 3.3V, 1.8V or external power VDD_J for digital circuit power.
26	VDDO1	J40	Power source selector. Select in 3.3V, 1.8V or external power VDD_J for OUT Bank 1.
27	VDDO2	J44	Power source selector. Select in 3.3V, 1.8V or external power VDD_J for OUT Bank 2.
28	B_VDDDIG	J75	Power source selector. Select in 3.3V or external power VDD_J for VDDIG digital power pin of RC19004A.
29	B_CLKN2	J59	Complementary clock output pin of RC19004A.
30	B_CLKP2	J60	True clock output pin of RC19004A.
31	BUFF_IN0	J85	Differential buffer Input 0.
32	BUFF_IN#0	J86	Differential buffer Input #0.
33	B_VDDCLK	J76	Power source selector, select in 3.3V or external power VDD_J for VDDCLK clock power supply pin of RC19004A.
34	RC19004A	U28	Fanout buffer.

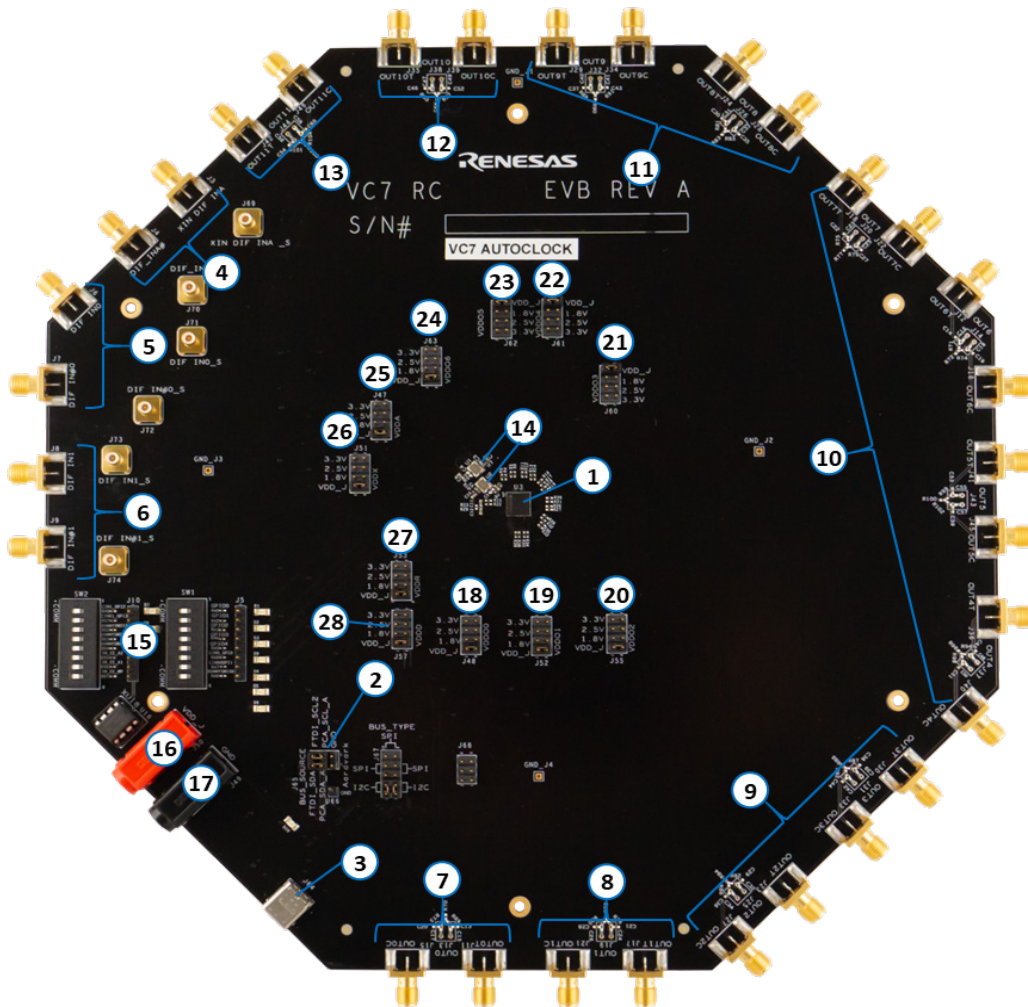

Figure 3. RC21211/RC21212 AutoClock Evaluation Board

Refer to Table 3 for the RC21211A/RC21212A evaluation board pin descriptions and functions.

Table 3. RC21211A/RC21212A – EVB Pins and Functions

Item	Name	On-Board Connector Label	Function
1	RC21212A	U3	Evaluation device, 6 × 6 × 0.9 mm 48-VFQFPN.
2	I ² C for FTDI or Aardvark Connector	J65	6 pins header of I ² C connector for SCL and SDA pins.
3	USB Interface	J64	USB-type jack for connection with the computer and interaction with RICBox software.
4	XIN0 / XOUT0 REFIN0 / REFIN0B	J3, J4	Differential REF clock input positive on J3 and negative on J4 / CMOS single-ended reference clock input. If J3 is connected to XIN0 as REFIN single-ended, J4 must be left unconnected.

Item	Name	On-Board Connector Label	Function
5	XIN1 / XOUT1 REFIN1 / REFIN1B	J6, J7	Differential REF clock input positive on J29 and negative on J31 / CMOS single-ended reference clock input. If J29 is connected to XIN1 as REFIN single-ended, J31 must be left unconnected.
6	GPIO5, GPIO6	J8, J9	GPIO5 and GPIO6 SMA connector.
7	Test Points for OUT0	J11, J15	SMA connectors for differential outputs using VDDO0 power rail (populated with a pair of SMA connectors): J11, J15 for OUT0
8	Test Points for OUT1	J17, J21	SMA connectors for differential outputs using VDDO1 power rail (populated with a pair of SMA connectors): J17, J21 for OUT1
9	Test Points for OUT2, OUT3	J23, J27, J30, J33	SMA connectors for differential outputs using VDDO2 power rail (populated with a pair of SMA connectors): J23, J27 for OUT2 J30, J33 for OUT3
10	Test Points for OUT4, OUT5, OUT6, OUT7	J36, J40, J41, J45, J12, J16, J18, J22	SMA connectors for differential outputs using VDDO3 power rail (populated with a pair of SMA connectors): J36, J40 for OUT4 J41, J45 for OUT5 J12, J16 for OUT6 J18, J22 for OUT7
11	Test points for OUT8, OUT9	J24, J28, J29, J34	SMA connectors for differential outputs using VDDO4 power rail (populated with a pair of SMA connectors): J24, J28 for OUT8 J29, J34 for OUT9
12	Test points for OUT10	J35, J39	SMA connectors for differential outputs using VDDO5 power rail (populated with a pair of SMA connectors): J35, J39 for OUT10
13	Test points for OUT11	J42, J46	SMA connectors for differential outputs using VDDO6 power rail (populated with a pair of SMA connectors): J42, J46 for OUT11
14	Crystal Pads	U1, U2	To mount different quartz crystals.
15	DIP Switches	SW1, SW2	DIP switch devices are used to setup GPIO/GPI pins based on RC21212A device condition (see Figure 8 and Figure 9).
16	Power VDD Jack	J50	External power supply, positive terminal. Apply 3.3V or 1.8V as default only.
17	Power GND Jack	J49	External power supply ground.
18	VDDO0	J48	Power source selector. Select 3.3V, 1.8V or external power VDD_J for OUT Bank 0.
19	VDDO1	J52	Power source selector. Select 3.3V, 1.8V or external power VDD_J for OUT Bank 1
20	VDDO2	J55	Power source selector. Select 3.3V, 1.8V or external power VDD_J for OUT Bank 2.

Item	Name	On-Board Connector Label	Function
21	VDDO3	J60	Power source selector. Select 3.3V, 2.5V, 1.8V or external power VDD_J for OUT Bank 3.
22	VDDO4	J61	Power source selector. Select 3.3V, 2.5V, 1.8V or external power VDD_J for OUT Bank 4.
23	VDDO5	J62	Power source selector. Select 3.3V, 2.5V, 1.8V or external power VDD_J for OUT Bank 5.
24	VDDO6	J63	Power source selector. Select 3.3V, 2.5V, 1.8V or external power VDD_J for OUT Bank 6.
25	VDDA	J47	Power source selector. Select 3.3V, 1.8V or external power VDD_J for analog circuit power
26	VDDX0 (VDDX)	J51	Power source selector. Select 3.3V, 1.8V or external power VDD_J for crystal circuit power
27	VDDX1 (VDDR)	J53	Power source selector. Select 3.3V, 1.8V or external power VDD_J for reference input circuit power
28	VDDD	J57	Power source selector. Select 3.3V, 1.8V or external power VDD_J for digital circuit power

1.2.2 On Board Crystal PAD and Reference Input

The EVB has two crystal pads U1 and U2 that are left uninstalled. Different crystal frequencies between 8MHz and 80MHz can be used to match the specific application where the RC21211/RC21212 is used. For example, it is recommended to use a 39.0625MHz or 62.5MHz crystal for Ethernet applications with output frequencies of 156.25MHz or 312.5MHz. Refer to the datasheet for more information on crystal recommendations. The RC2121xA devices supports a range of C_L from 6pF to 12pF.

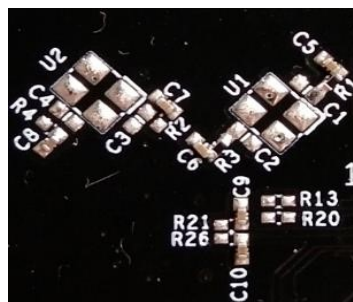

Figure 4. Crystal Footprints

The XIN0/REFIN0 input (J3/J4) can be used to overdrive the XIN pin with an external clock with SMA connectors in single-ended or differential mode. Supported frequency range of the reference input are 1kHz to 650MHz in differential mode, and 8kHz to 250MHz in single-ended mode.

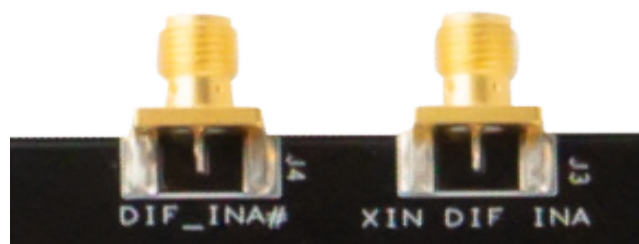

Figure 5. Single-ended Differential Ref Input

1.2.3 Serial Connection

The EVB can be connected to a computer via a USB-C connector. The on-board USB-to-MPSSE Bridge (FTDI FT232HQ) can handle the data communication. The +5V from the USB-C powers the on-board regulators or external +5V via banana connector.

RC2121xA devices only supports I²C. Pins 1 and 2 in J65 are SDA and SCL from the FTDI chip. Pins 3 and 4 pass the SDA and SCL to the I²C level shifter. To use the on-board FTDI chip, install jumpers on pins 1–3 and 2–4. Pin 6 can be used as the ground connection for the I²C connection. By removing this jumpers, pins 3, 4, 5 and 6 are arranged so that an Aardvark connector can be plugged onto these pins (see Figure 6).

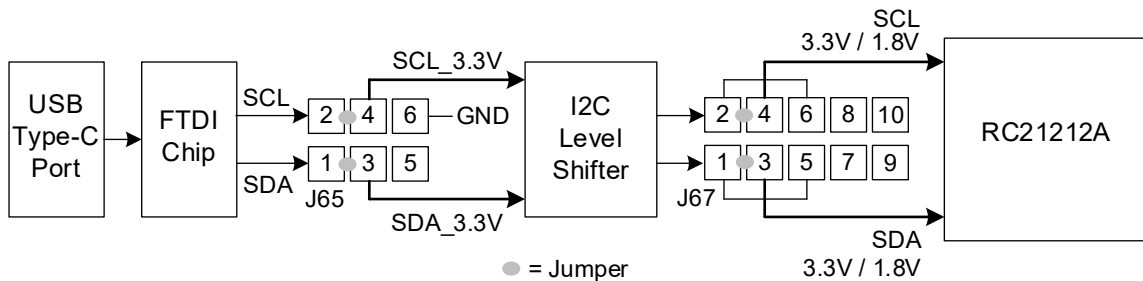

Figure 6. Communication Setup for I²C Mode

In Figure 7, the Aardvark adapter communicates with the RC21211/RC21212.



Figure 7. Aardvark Adapter Connection to J65

1.2.4 GPI/GPIO DIP Switch Selectors

The EVB has two DIP switches (SW1, SW2) to support GPIO and GPI pins on an RC21211/RC21212 device. The middle position leaves the pin open so GPIO0, GPIO1, GPIO2, GPIO3, GPIO4, GPIO5, and GPIO6 could be configured to be 2-level (Hi / Low) as default selection on DIP switches. This is the default setting for each switch on the EVB board. Move to the “+” side to pull the pin high and move to the “-” side to pull the pin low.

Table 4. SW1 Description



Figure 8. DIP Switch SW1

Switch 1 = GPIO0	Connects to Pin13 as general-purpose input/output 0. Set to middle as default on EVB.
Switch 2 = GPIO1	Connects to Pin14 as general-purpose input/output 1. Set to middle as default on EVB.
Switch 3 = GPIO2	Connects to Pin15 as general-purpose input/output 2. Set to middle as default on EVB.
Switch 4 = GPIO3	Connects to Pin16 as general-purpose input/output 3. Set to middle as default on EVB.
Switch 5 = GPIO4	Connects to Pin17 as general-purpose input/output 4. Set to middle as default on EVB.
Switch 6 = NA	Connects to Pin5 as general-purpose Input 0. Set to middle as default on EVB.
Switch 7 = NA	Connects to Pin6 as general-purpose Input 1. Set to middle as default on EVB.
Switch 8 = NA	No connection.

Table 5. SW2 Description

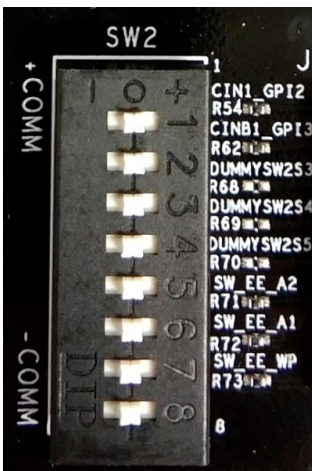

Figure 9. DIP Switch SW2

Switch 1 = GPIO5	Connects to pin 8 as general-purpose input/output 5. Set to middle as default on EVB.
Switch 2 = GPIO6	Connects to pin 9 as general-purpose input/output 6. Set to middle as default on EVB.
Switch 3 = Dummy	No connection.
Switch 4 = Dummy	No connection.
Switch 5 = Dummy	No connection.
Switch 6 = NA	No connection.
Switch 7 = NA	No Connection.
Switch 8 = NA	No Connection.

GPI pins are only available for use in single crystal input variants. In order to use GPIO0 and GPI1 in dual crystal/reference input variants, XTAL1 must not be used. GPIO pins 5 and 6 can also be pulled Hi / Lo by applying voltage on SMA J8 and J9.

1.2.5 Outputs

For RC21211/RC21212, twelve differential output pairs can be programmed (out_mode) to LVDS, LP-HCSL or LVCMOS logic type. LVCMOS is a single-ended logic type, and the output pair will essentially be two CMOS outputs of the same frequency.

LP-HCSL is the most versatile output because it can be customized. The LP-HCSL driver is simply a voltage push-pull driver. The RC21211/RC21212 LP-HCSL can be programmed (out_lpamp) to different amplitudes (800mV, and 900mV). The slew rate can be programmed (out_lpsr) to slow, 2–4 V/ns or fast, > 4V/ns. The output impedance can be programmed (out_lpimp) to 100Ω or 85Ω differential. When AC coupled, the LP-HCSL driver can be compatible with LVDS and LVPECL signal swing requirements. The single-ended outputs support LVCMOS swings of 1.8V or 3.3V as determined by their VDDO voltage.

For LVCMOS output type, output phase can be programmed (out_prog0 or out_prog1) to be out-of-phase or in-phase. Each output can also be tri-stated (out_prog2/out_prog3). The slew rate can also be programmed (out_cmdrv) to 4.2 / 2.7 / 3.4 V/ns for 3.3V, or 1.8 / 1.9 V/ns for 1.8V.

RC2121xA devices are defaulted with LP-HCSL output type on all outputs of the EVB. Figure 10 shows the default output termination for LP-HCSL with SMA connectors (J35, J39).

Note: Some features of this EVB are not available for RC2121xA devices. In Figure 11, **DNI** denotes *Do Not Install*.

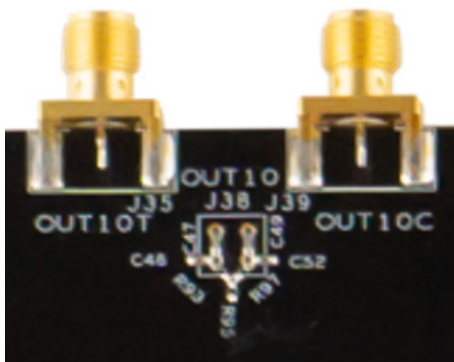

Figure 10. Output Termination with SMA Connector

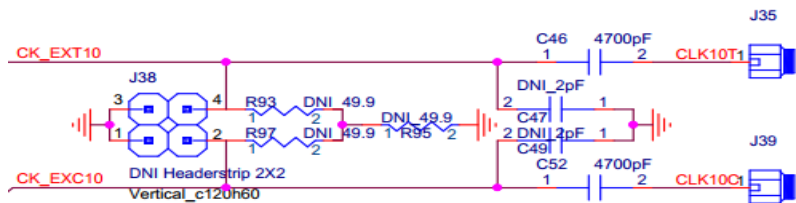

Figure 11. Output Termination with Bias Schematic

1.2.6 Power and USB connection to Computer Host

The EVB is connected to a computer via the USB cable (see section 1.2.3) and is recommended that the cable is connected to a USB 2.0 port. The USB provides +5V as power source to the on-board regulators. The on-board regulators support 3.3V and 1.8V voltages to the entire EVB.

The voltage source can be either from on-board voltage regulators for 3.3V, 1.8V or from VDD_J banana connector. The banana connector can connect to a bench supply and the connection can be used to measure total supply current into pins as reference. When all powers are selected from the VDD_J power jack, the USB connection will still be needed to connect to the computer for programming RC2121xA devices using RICBox.

In Figure 12, the source for pin VDDO1 (J52) is chosen to be VDD_J. To select 3.3V, the jumper can be moved to the top of header J52.

Important: Do not use 2.5V power supply for RC2121xA devices. For more information, refer to the [RC2121xA datasheet](#).

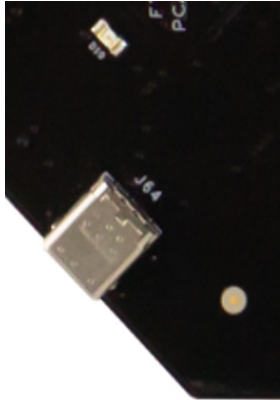

Figure 12. Power Source from USB Connector

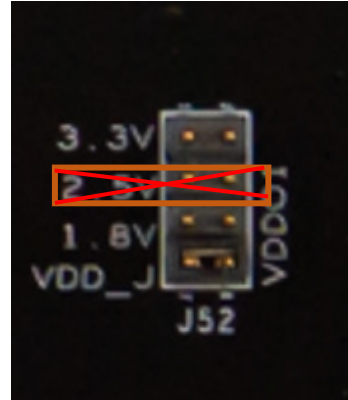

Figure 13. Power Source Selection

1.2.7 Renesas Integrated Circuit Toolbox (RICBox)

The Renesas Integrated Circuit Toolbox (RICBox) software can program RC2121xA devices on the EVB using either the on board FTDI chip or Aardvark tool. RICBox provides a user-friendly interface to support programming configurations into an RC2121xA device on the board. For more information about RICBox, see the [Renesas IC Toolbox User Guide](#).

1.2.8 Programming an RC2121xA Device using RICBox Software

1. Connect J64 on the EVB to the user's computer using a USB cable.
2. Launch RICBox as described in the [Renesas IC Toolbox User Guide](#).
 - a. The software and guide are downloadable from the product page.
3. For a new configuration, click on *Create new project*.

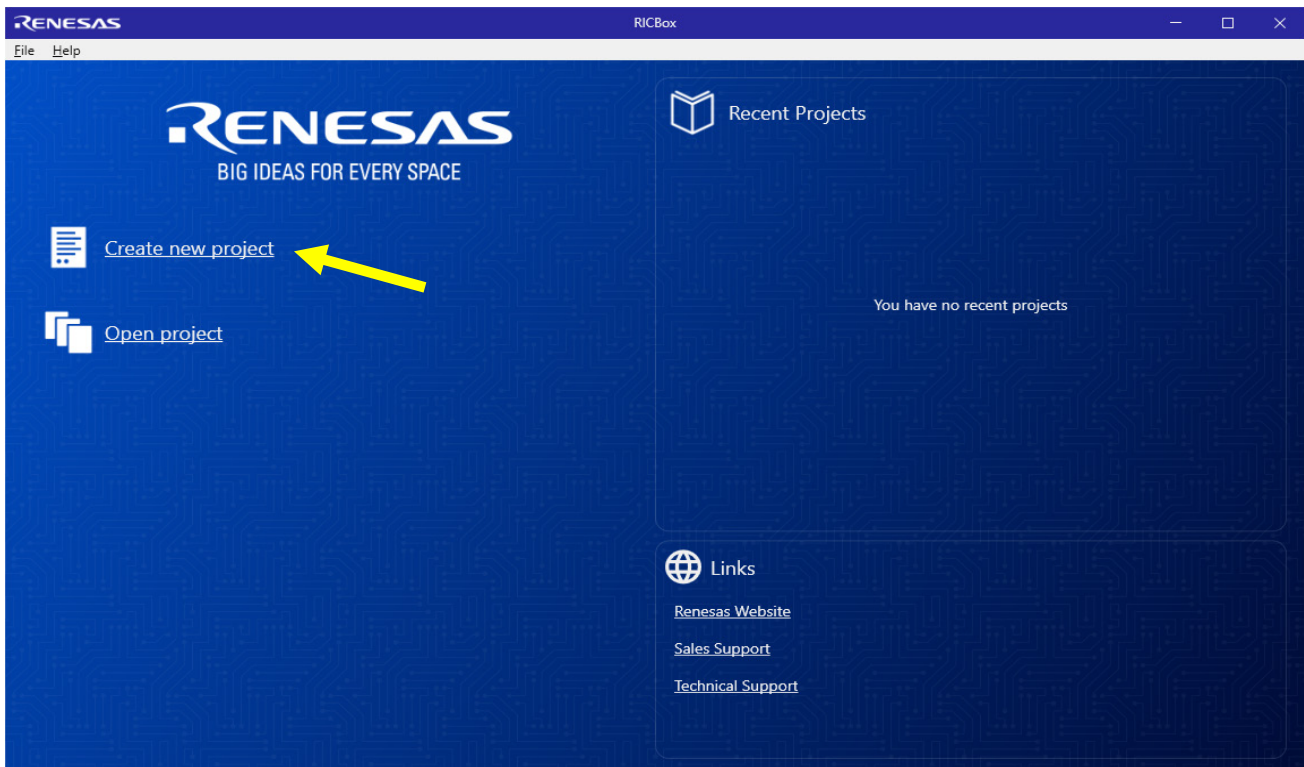

Figure 14. RICBox Start Page

- Select the AutoClock product family, then select a product variant (part number) and click OK.

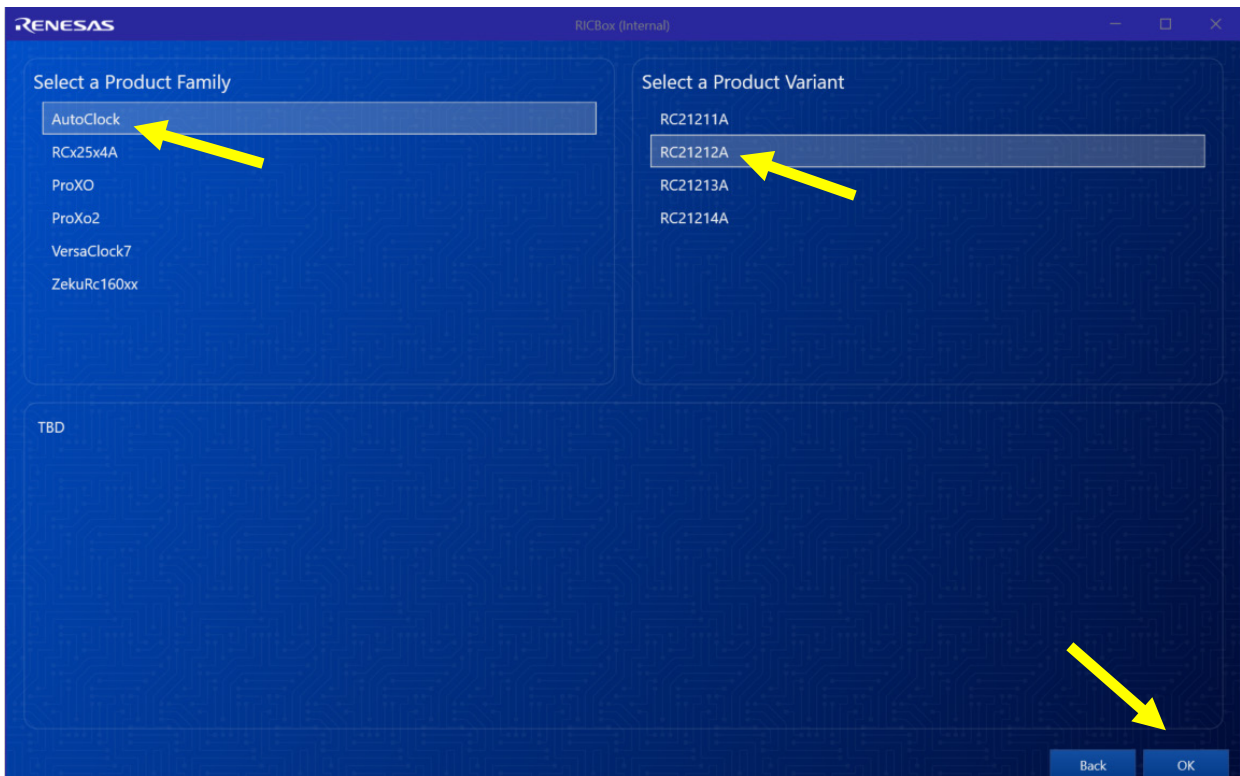

Figure 15. Select Product Family and Variant

- On the Inputs wizard page, mode for XTAL0/1 REFIN0/1 can be set (Xtal, Differential, Single-ended). Expected input frequency needs to be entered. The C_L can also be set internally between 6pF to 12pF.

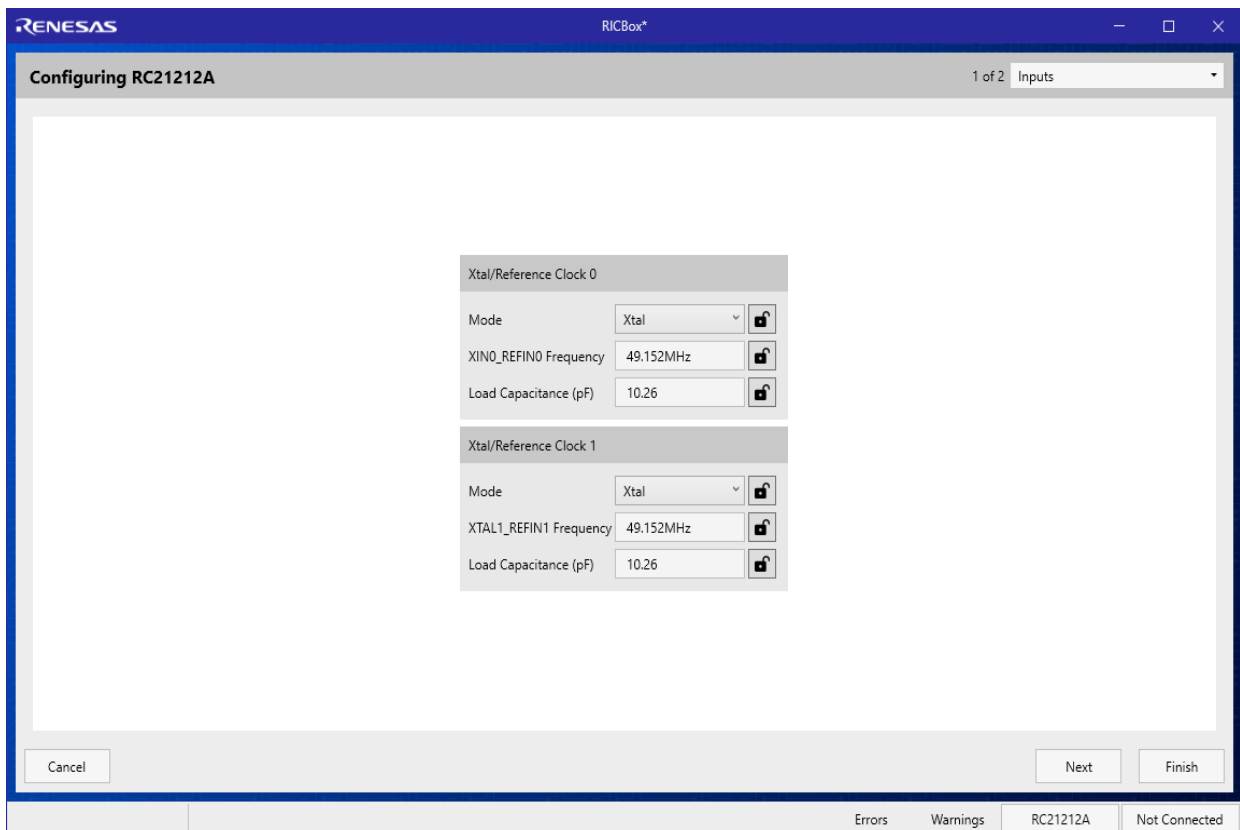



Figure 16. Inputs Wizard Page

- Configure the output bank settings which includes the divider source (LPFOD0/1, IOD0/1, or HPFOD0/1/2), output frequency and output mode (LPHCSL, LVDS, and LVCMOS). If a bank is to be unused, use the “Power Down” check box to turn off the bank. Click on the settings icon  to adjust amplitude, impedance, and slew rate for each output (see Figure 18).

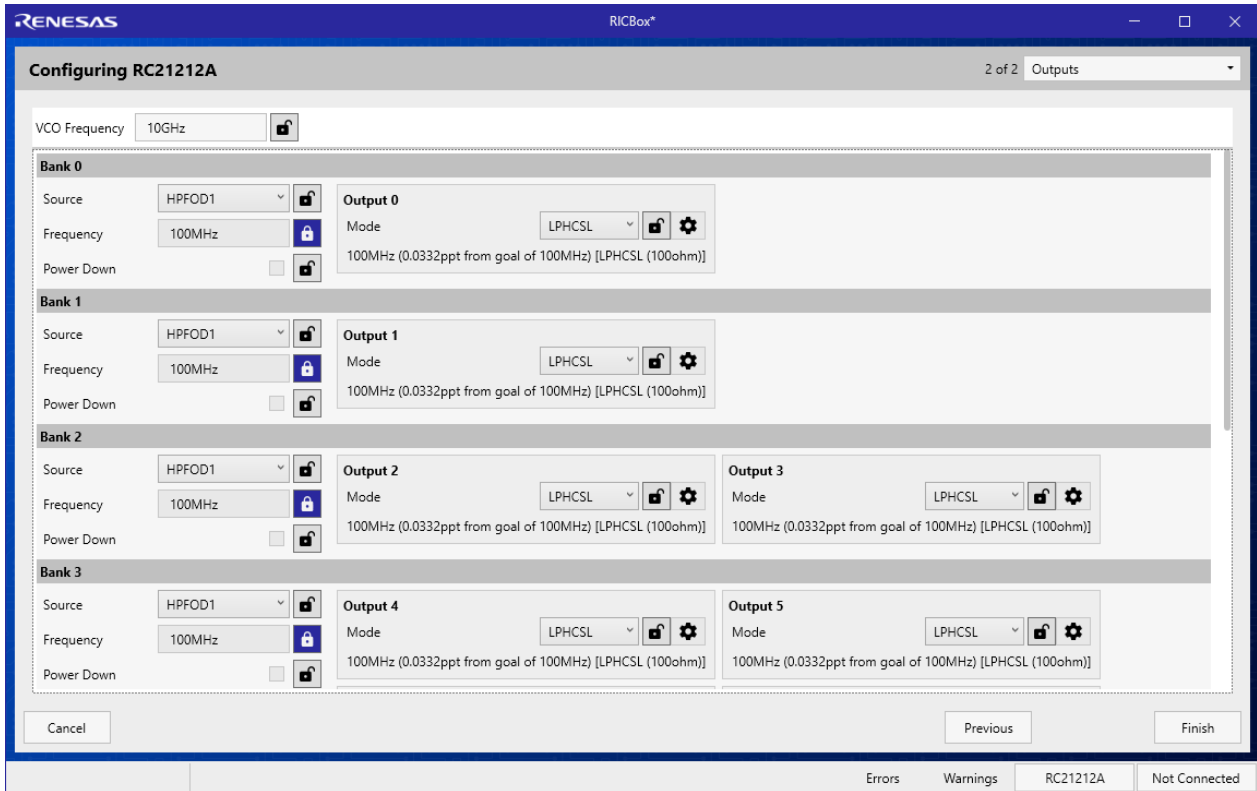

Figure 17. Outputs Wizard Page

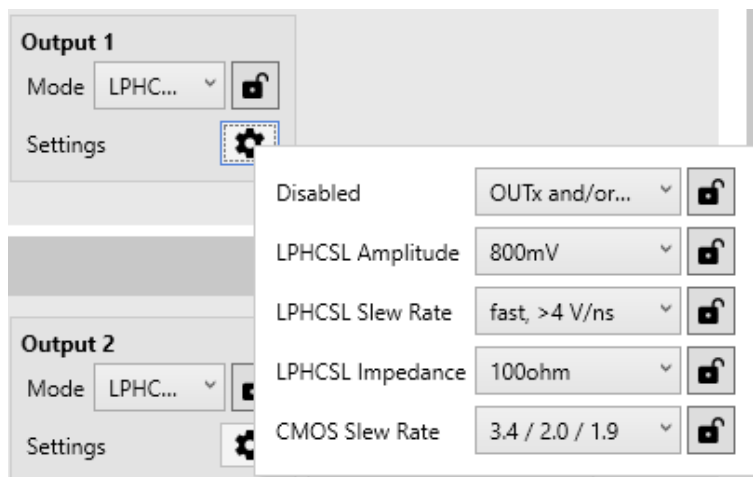

Figure 18. Advanced Output Settings

7. Click the *Finish* button (see Figure 17) to view the summary of the configuration.

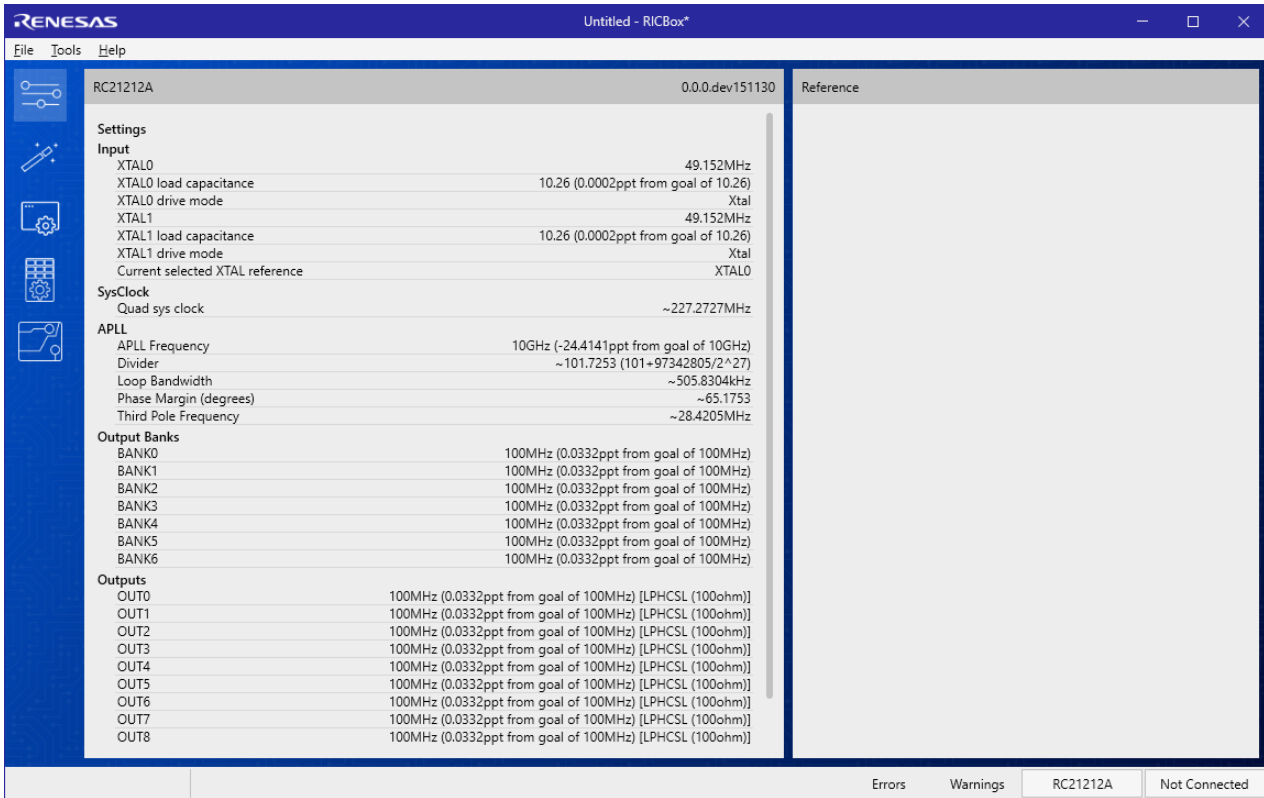

Figure 19. Configuration Summary

- To go back to any of the previous wizard pages, click the wizard icon.
- RICBox is now ready to connect to an RC2121xA device. Click on the *Not Connected* button in the lower right part of RICBox tool. Then click *Connect*.

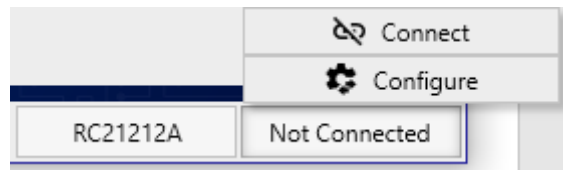

Figure 20. Connect to AutoClock

10. The “Not Connected” button will turn green and changed to “Connected”. Click the *Connected* button again and select “Program” to start programming the part.

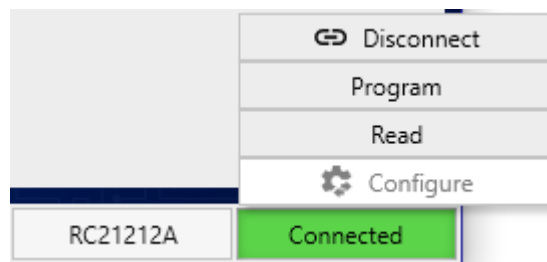



Figure 21. Program AutoClock

11. View the block diagram by pushing the Block Diagram  icon.

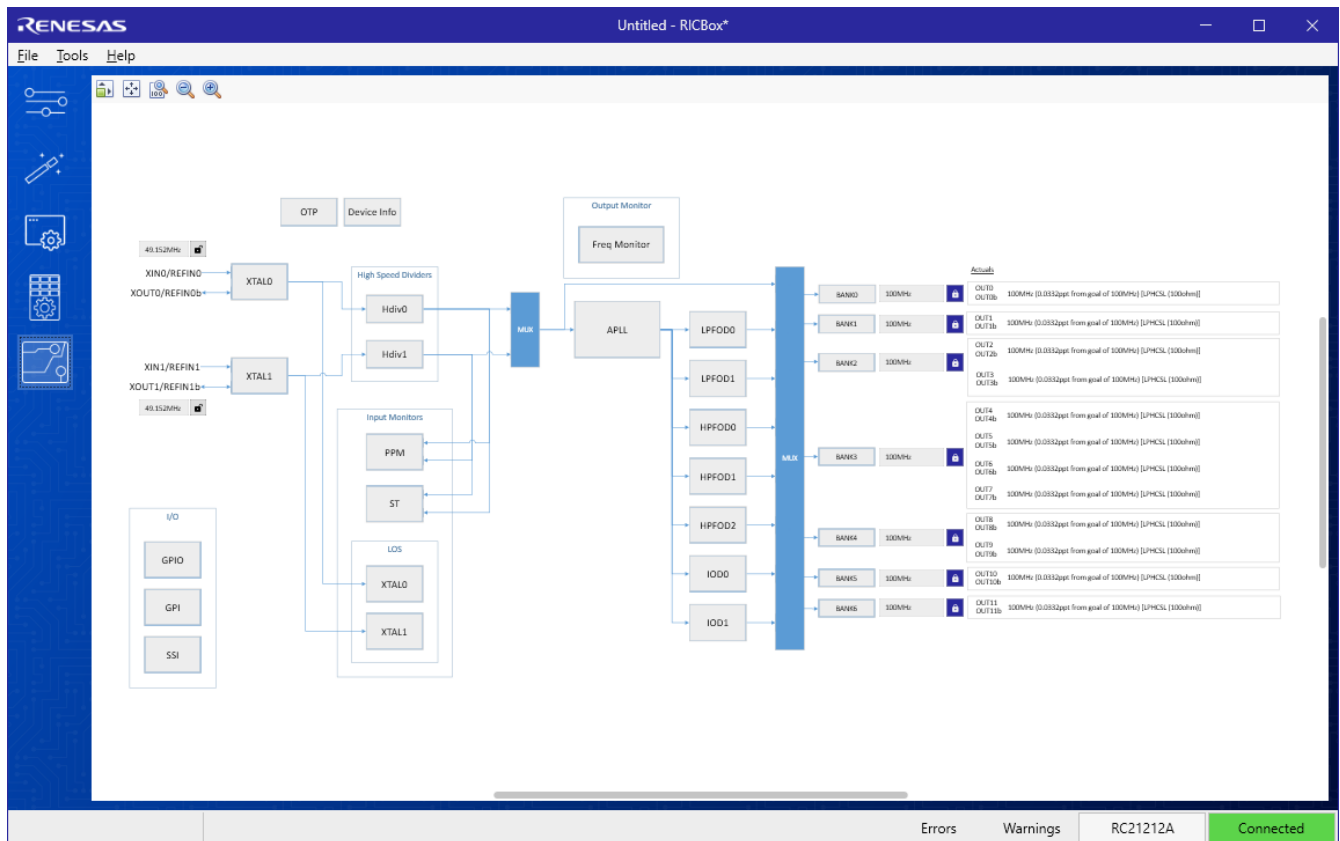

Figure 22. Block Diagram

2. Evaluation Board Components

2.1 Layout Guidelines

Use the following list of items and their guidelines when designing the layout around the RC2121xA devices.

2.1.1 ePAD

For maximizing heat removal, a land pattern must be incorporated on the PCB within the footprint of the package corresponding to the exposed metal pad or exposed heat slug. Design in sufficient clearance on the PCB between the outer edges of the land pattern and the inner edges of pad pattern for the leads to avoid any shorts. Ensure there are enough vias to allow for proper thermal dissipation. These vias act as “heat pipes”. A via diameter around 12 to 13 mils (0.30 to 0.33 mm) with 1oz copper via barrel plating is recommended. Precaution should be taken to eliminate any solder voids between the exposed heat slug and land pattern. The ePAD may be connected to VEE (negative power supply) to allow for split power planes for different input/outputs styles (see Figure 23).

Note: These recommendations are to be used as a guideline only. For additional information, see the Application Note on the Surface Mount Assembly of Amkor’s Thermally/ Electrically Enhance Lead Frame Base Package, Amkor Technology.

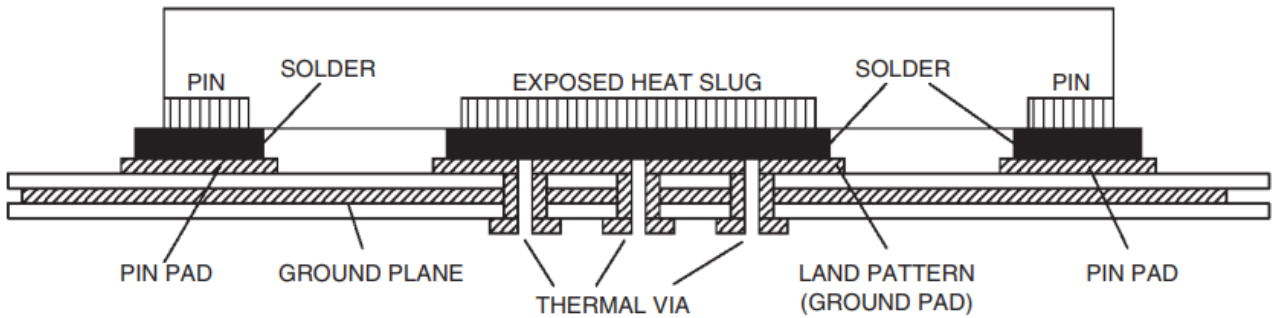

Figure 23. PCB Assembly for Exposed Pad Thermal Release Path – Side View

Table 6. Thermal Characteristics (40-pin)

Symbol	Parameter ^[1]	Value	Unit
θ_{JC}	Junction to Device Case Thermal Coefficient ^[2]	26.9	°C/W
θ_{JB}	Junction to Board Thermal Coefficient ^[2]	1.3	
θ_{JA}	Junction to Ambient Air Thermal Coefficient (still air)	30.5	
	Junction to Ambient Air Thermal Coefficient (1m/s airflow)	26.8	
	Junction to Ambient Air Thermal Coefficient (2m/s airflow)	25.2	
	Junction to Ambient Air Thermal Coefficient (3m/s airflow)	24.3	
-	Moisture Sensitivity Rating (Per J-STD-020)	3	-

1. Multi-Layer PCB with two ground and two voltage planes.
2. Assumes ePAD is connected to a ground plane using a grid of 25 thermal vias

Table 7 Thermal Characteristics (48-pin)

Symbol	Parameter ^[1]	Value	Unit
θ_{JC}	Junction to Device Case Thermal Coefficient ^[2]	20.1	°C/W
θ_{JB}	Junction to Board Thermal Coefficient ^[2]	1.9	
θ_{JA}	Junction to Ambient Air Thermal Coefficient (still air)	25.2	
	Junction to Ambient Air Thermal Coefficient (1m/s airflow)	21.7	
	Junction to Ambient Air Thermal Coefficient (2m/s airflow)	20.2	
	Junction to Ambient Air Thermal Coefficient (3m/s airflow)	19.3	
-	Moisture Sensitivity Rating (Per J-STD-020)	3	-

1. Multi-layer PCB with two ground and two voltage planes.
2. Assumes ePAD is connected to a ground plane using a grid of 25 thermal vias.

2.1.2 Crystal/Reference Input

Place the crystal as close to the AutoClock device as possible. Make XIN/XOUT trace lengths the same. For external tuning caps, connect them from XIN/XOUT to ePAD reference voltage. For single-ended reference input, route only the REFIN trace as single-ended 50Ω. For differential input, route differential 50Ω.

2.1.3 Serial Connection

The serial interface can function from 1.8V to 3.3V for VDDD. If serial communication is needed, the SCL and SDA pull-up resistor needs to connect to VDDD. If needed, use a level translator. Acceptable values for pull-up resistors are 1kΩ to 10kΩ. It is recommended to route the serial signals close to each other.

2.1.4 GPI/GPIO

In order to utilize GPI, XTAL1 input must be disabled as they share the same pins. The logic levels are determined by VDDD relative VEE. The GPI/GPIO can be configured to have internal pull-up/down. Signals should be routed to minimize return loops.

2.1.5 Outputs

For LVCMOS outputs type, route single-ended 50Ω and place an inline 33Ω resistor near the AutoClock device. For differential outputs type, route differential 50Ω. For LPHCSL, an inline 7.5Ω resistor near the AutoClock device is needed if output impedance is set to 85Ω. For LVDS, add 100Ω across P and N if the receiver does not have built-in termination. Inline capacitors may be used to AC couple the outputs as needed.

2.1.6 Power

Please follow the recommended schematic for power filtering. Each 0.1μF needs to be placed as close as possible to the respective RC21212A power pin. For a 1.8V setup, choose feed-through capacitors that minimize voltage drop. For a 3.3V setup, recommended ferrite beads(as described in [AN-805](#)) can be used with a DC resistance of less than 0.4 ohms.

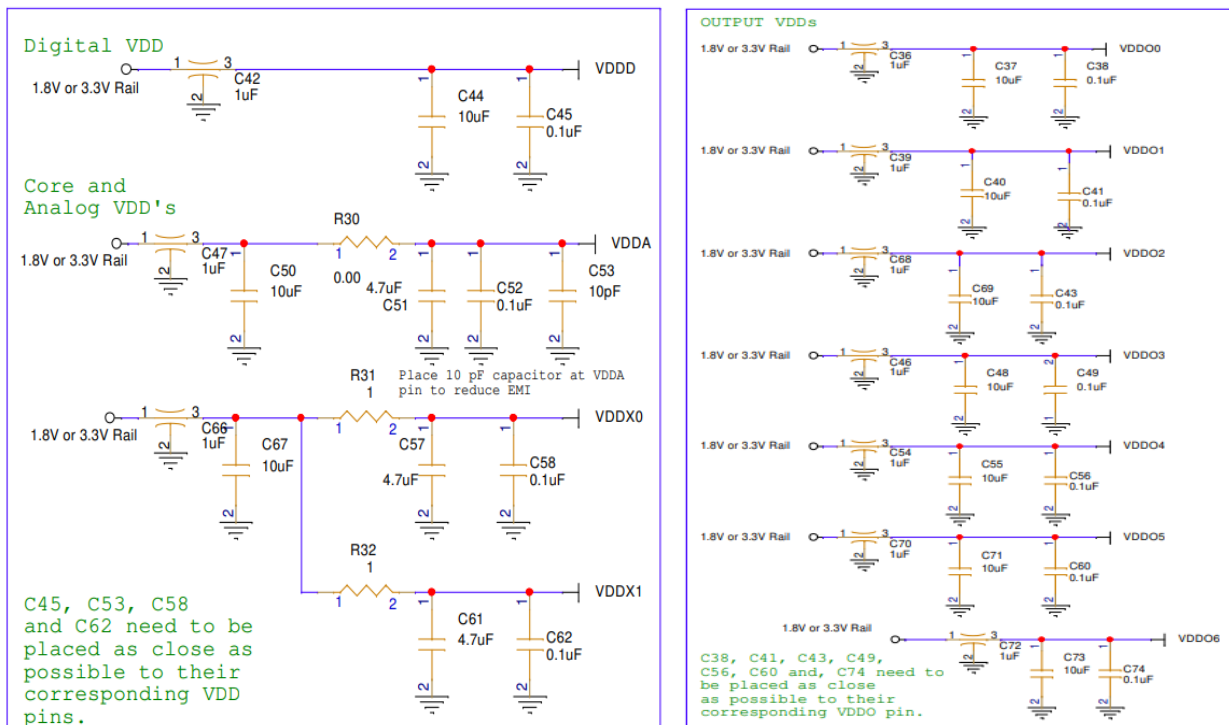

Figure 24. Power Supply Filtering

2.2 Schematic Diagrams

2.2.1 Schematics for 40-Pin VFQFPN

Schematics for the AutoClock 40-pin VFQFPN device are appended at the end of this document.

2.2.2 Schematics for 48-Pin VFQFPN

Schematics for the AutoClock 48-pin VFQFPN device are appended at the end of this document.

2.3 Board Layout

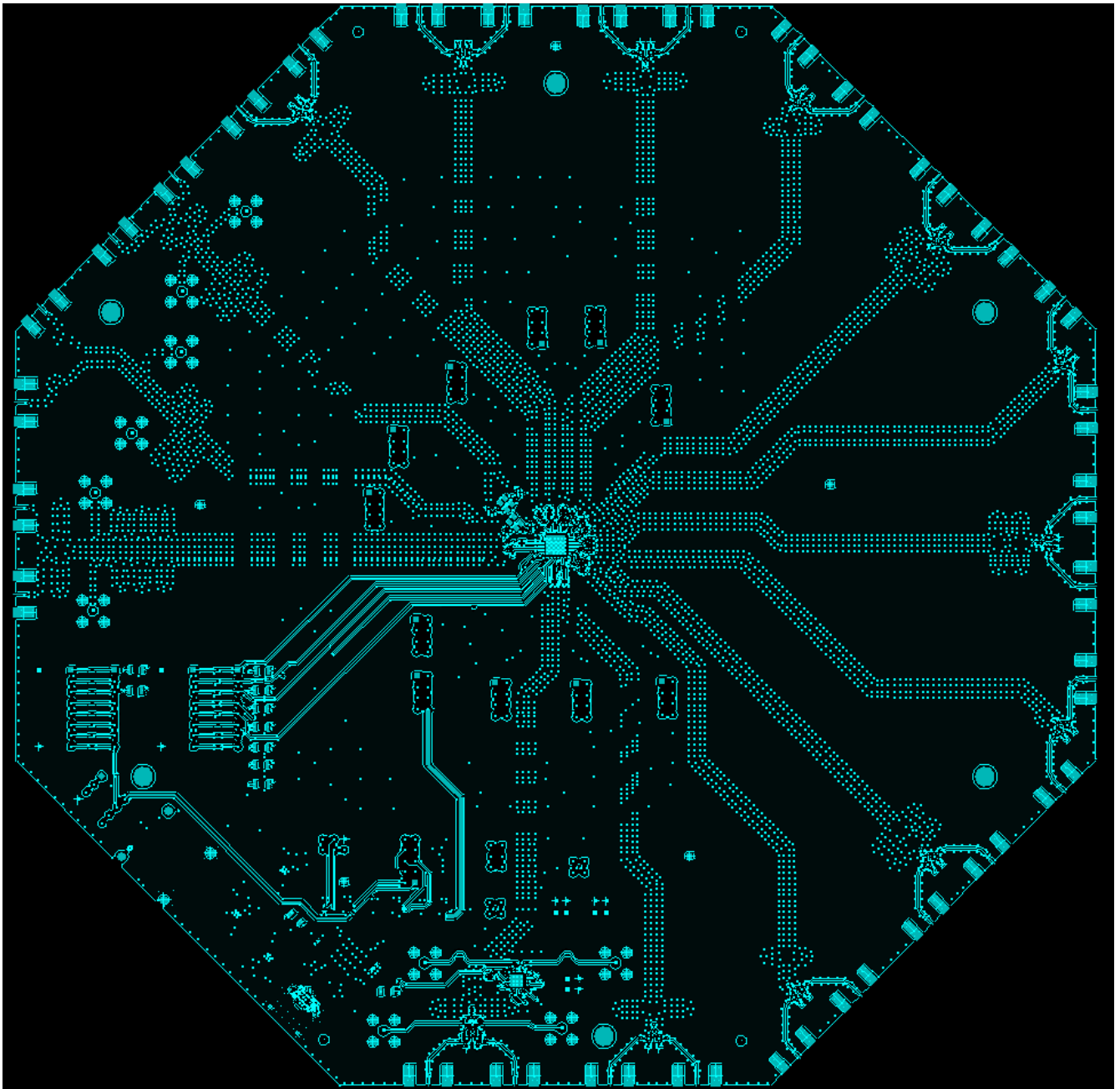

Figure 25. Layer 1 – Top

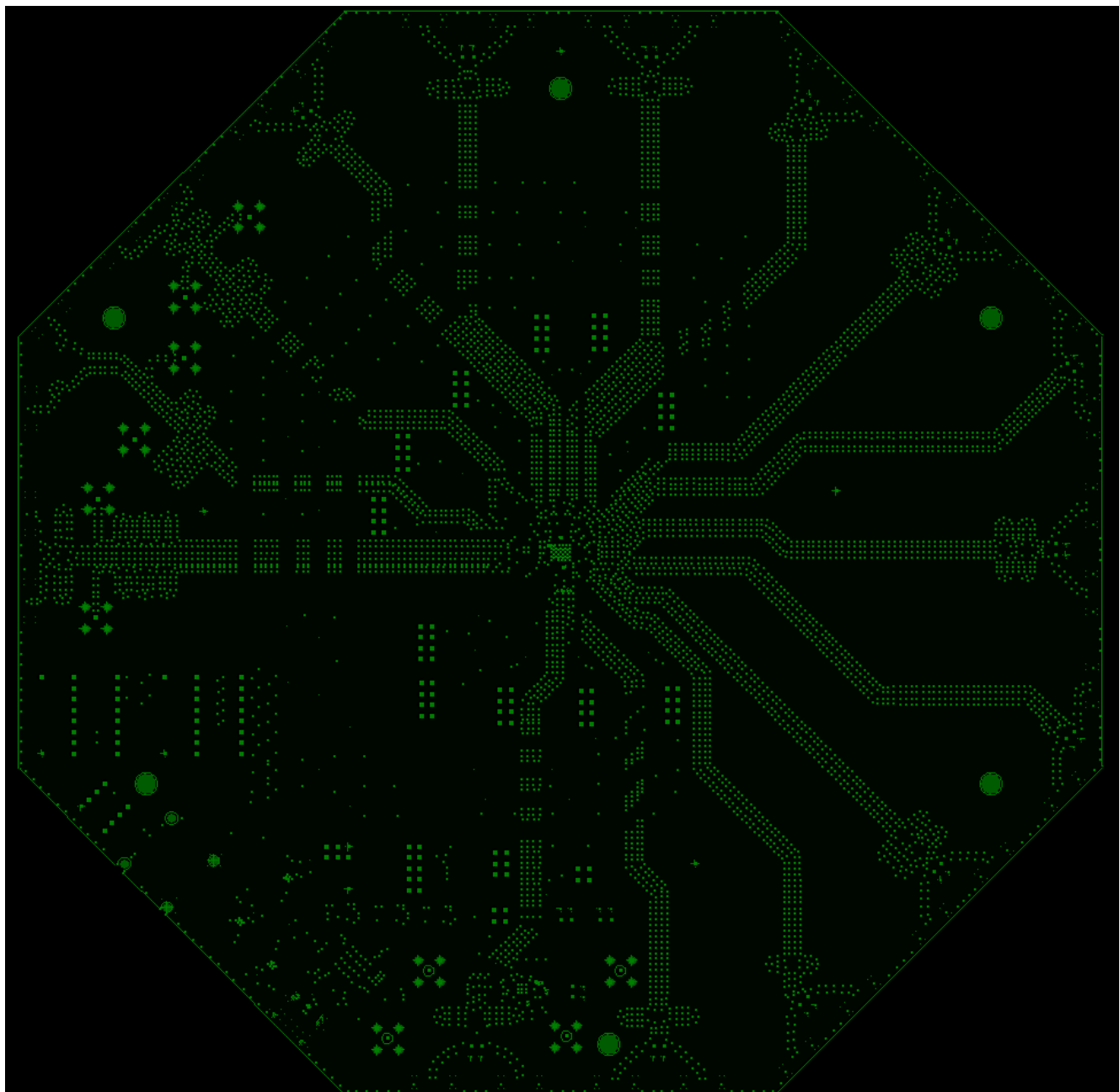

Figure 26. Layer 2 – Signal

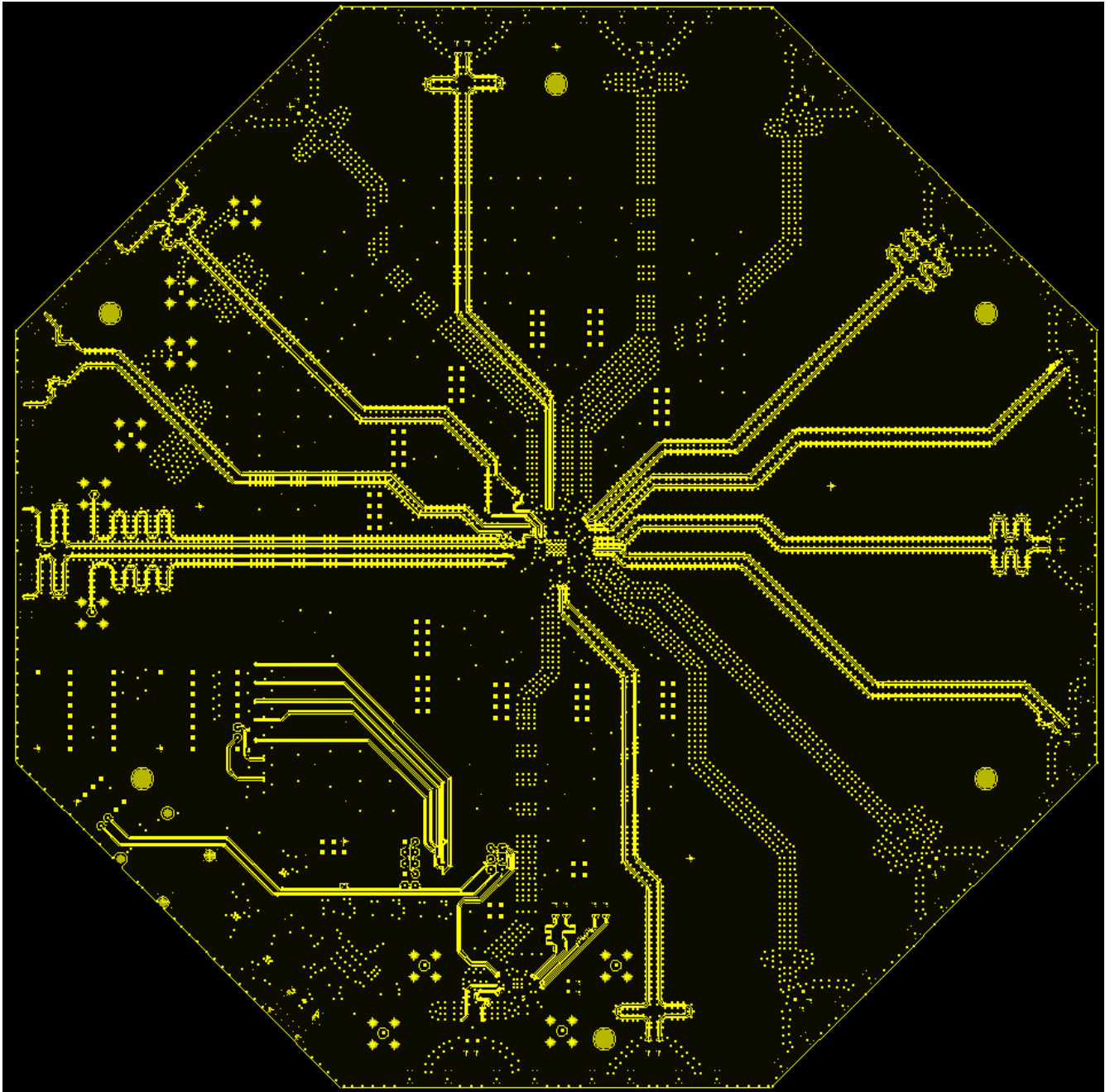

Figure 27. Layer 3 – Clock Signals

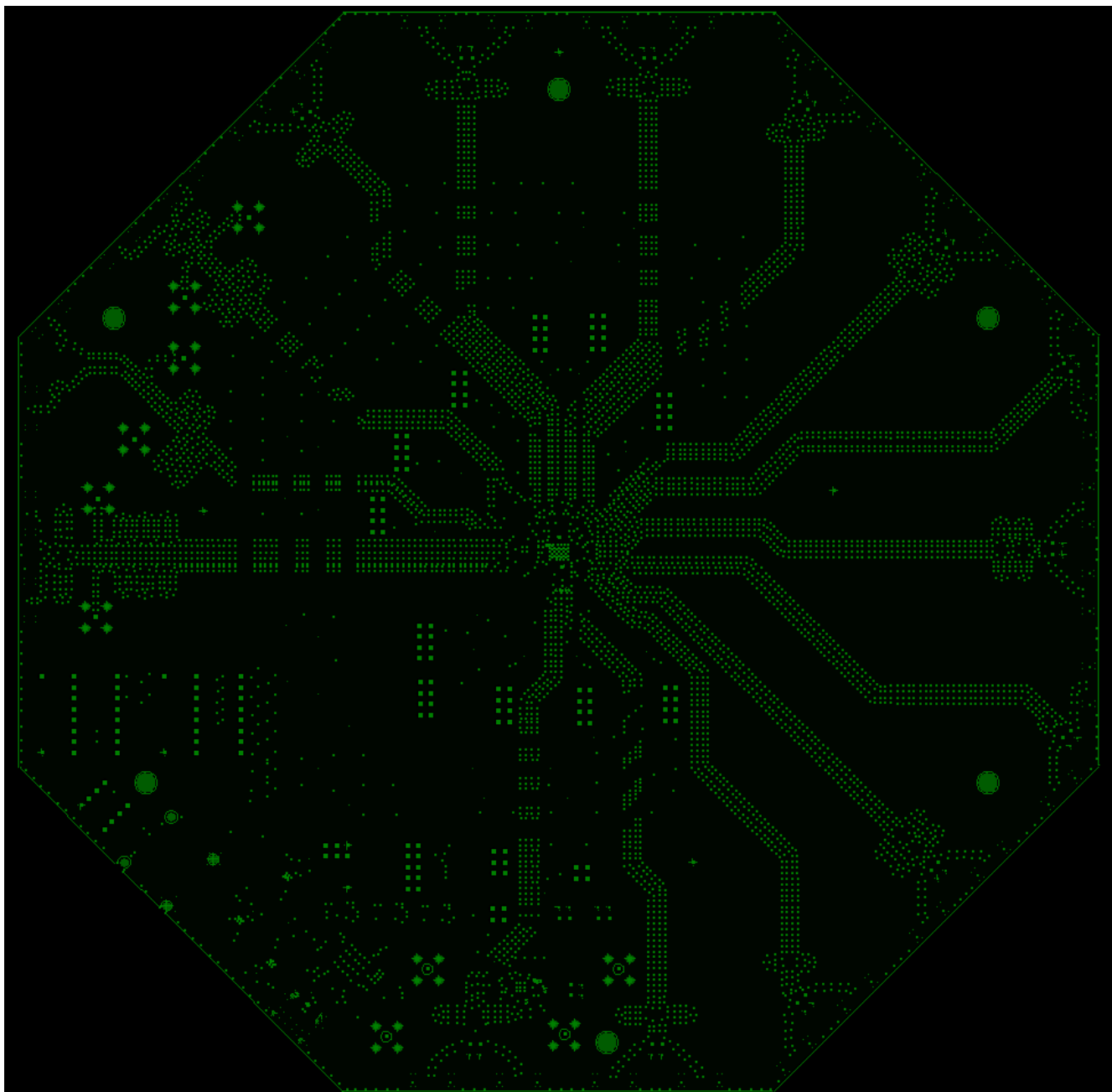

Figure 28. Layer 4 – GND Plane

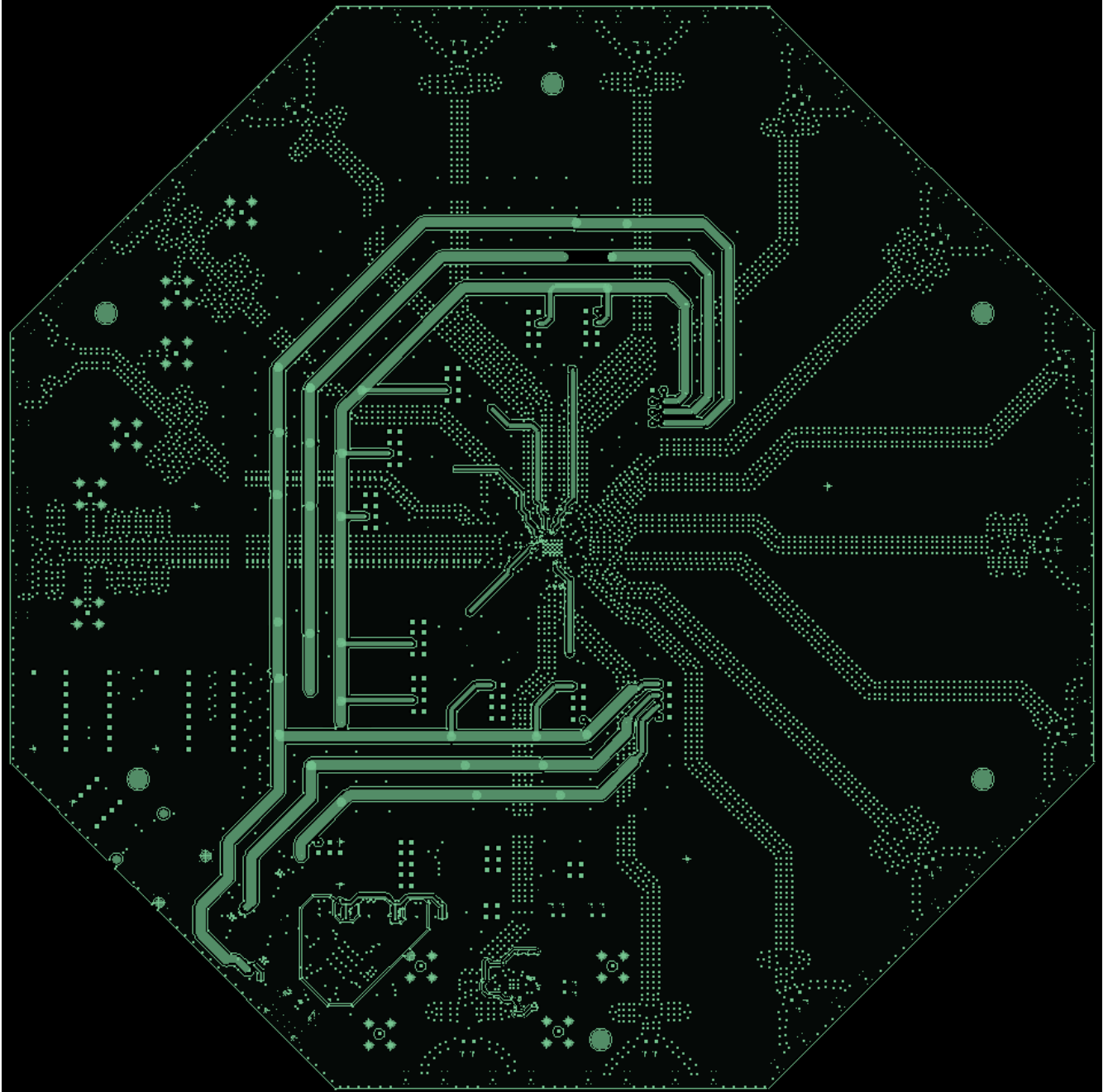

Figure 29. Layer 5 – Power Plane

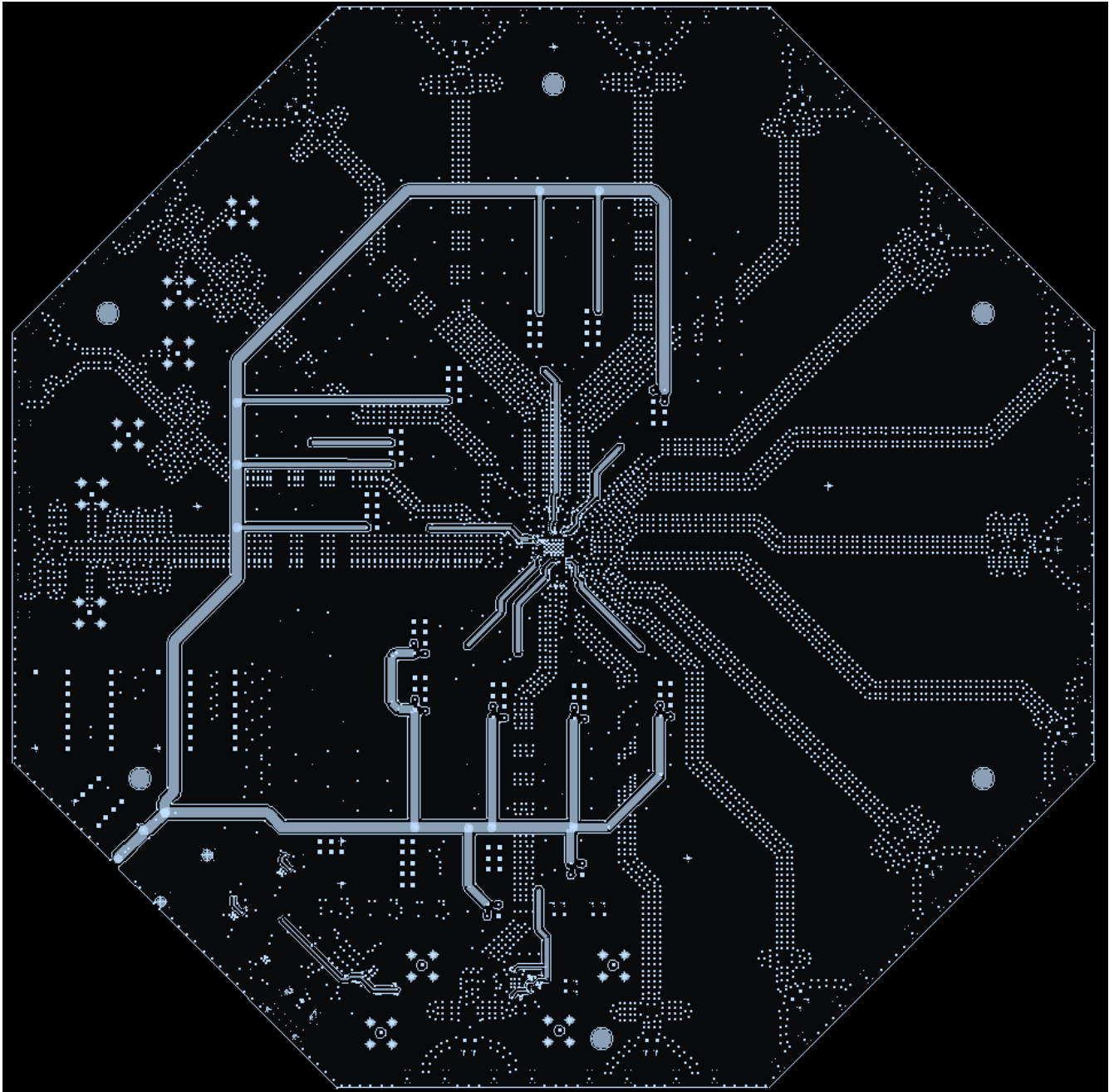

Figure 30. Layer 6 – Power Plane

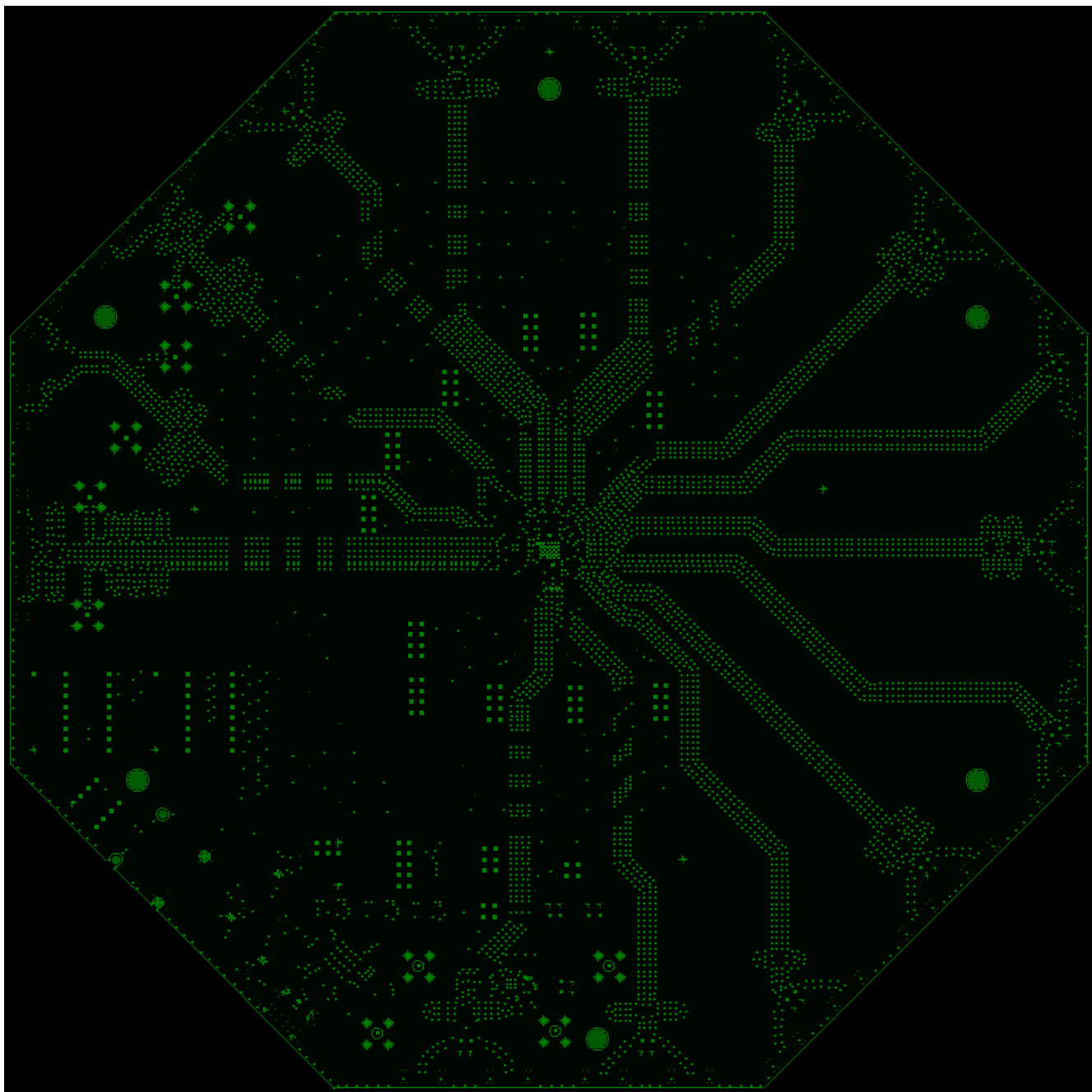

Figure 31. Layer 7 – Ground Plane

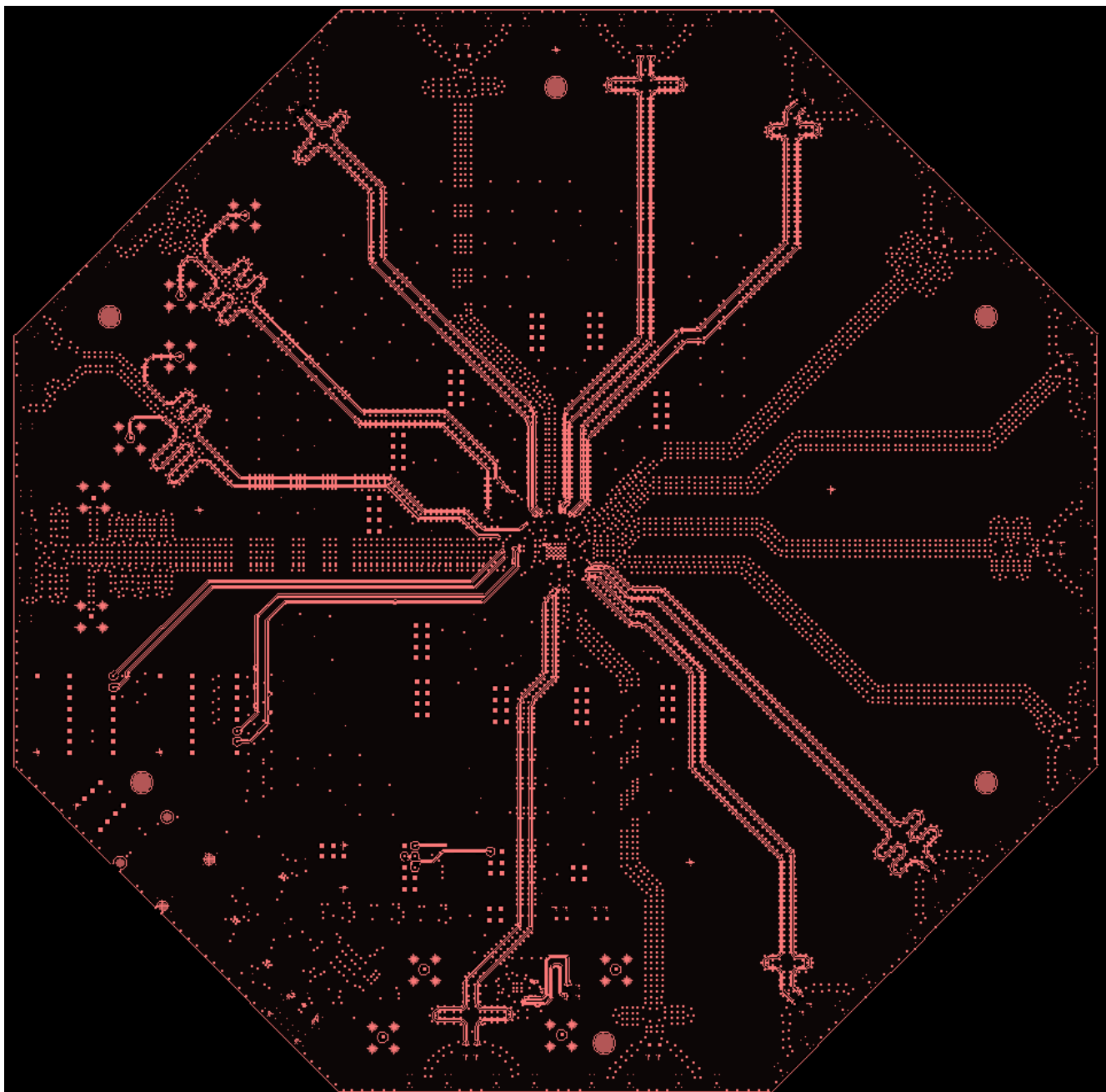

Figure 32. Layer 8 – Signal

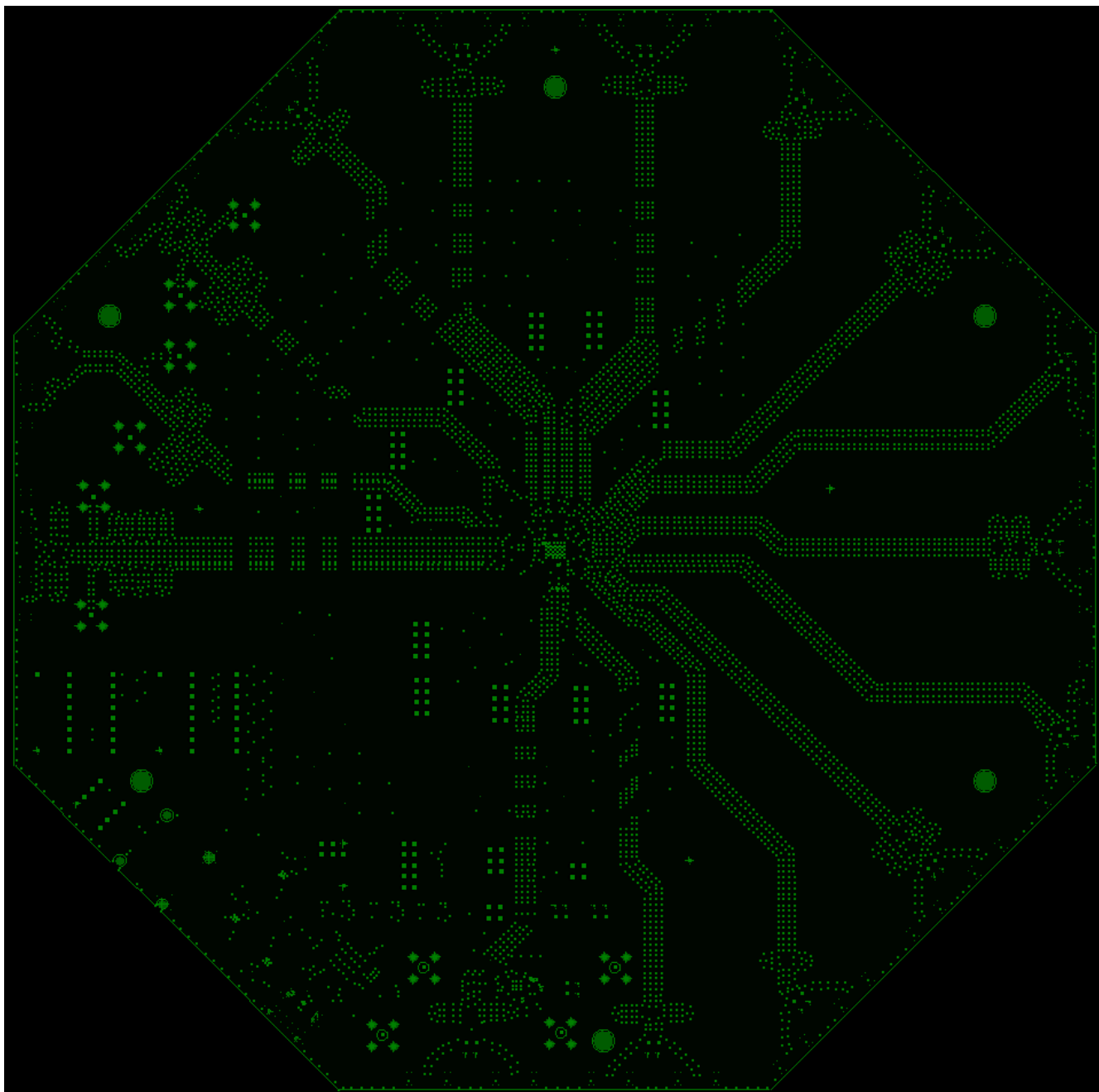

Figure 33. Layer 9 – Ground Plane

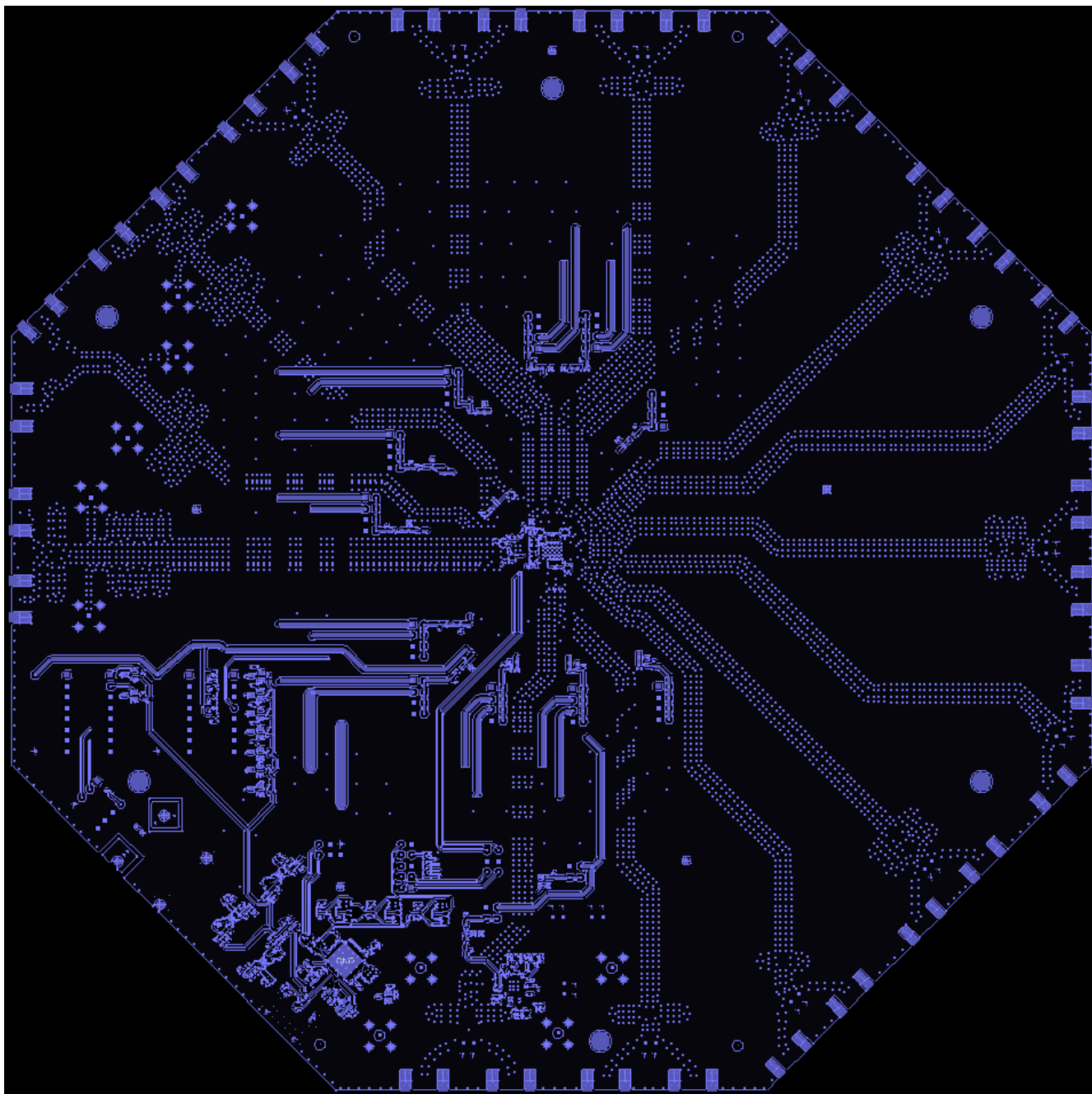

Figure 34. Layer 10 – Bottom

3. Quick Start Guide

1. Initiate the process by connecting the Evaluation Board (EVB) to your computer using a USB-C cable. This connection will also provide power and set up the communication to the board.
2. If you prefer using an external power instead of the USB, flip the power source selector on the EVB to 'VDD_J'.
3. Install the RICBox software. You'll find all the instructions in the [Renesas IC Toolbox Software Manual](#).
4. After installing, configure your board as explained in section 1.2.7.
5. Program the board as per the configuration. This configuration can be saved in ".rbs" format.
6. Conduct your measurements using the Phase Noise Analyzer (PNA), such as the E5052 or FSWP.

4. Ordering Information

Part Number	Description
RC21212-EVB	AutoClock – 12-output Evaluation Board
RC21214-EVB	AutoClock – 8-output Evaluation Board

5. Revision History

Revision	Date	Description
1.00	Apr 25, 2024	Initial release.

FTDI Controls
I2C/SPI

Aardark Connector on pins 3, 4 and 6 for I2C control.

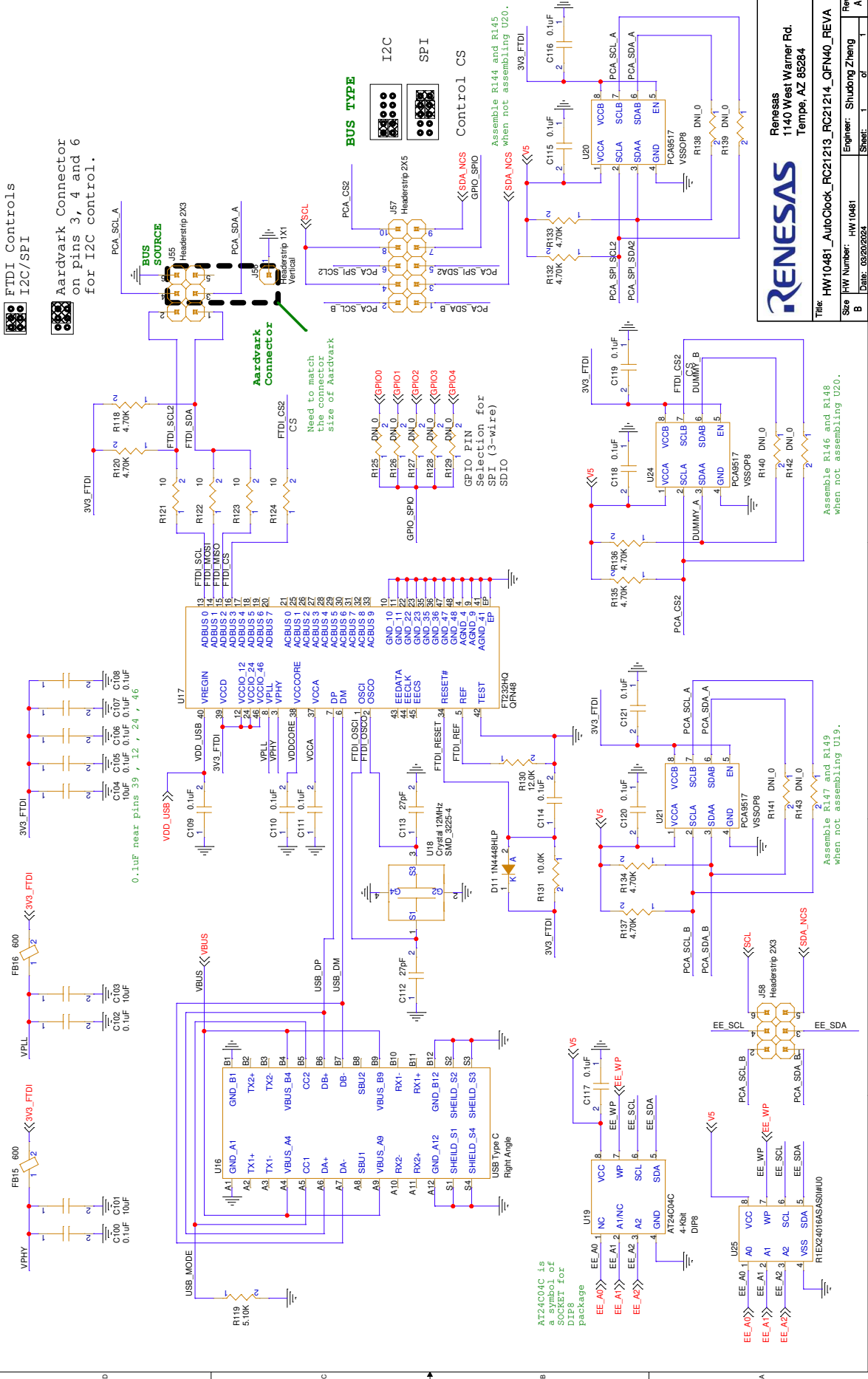

Renesas
1140 West Warner Rd.
Tempe, AZ 85284

Title: HW10481_AutoClock_RC21213_RC21214_QFN40_REVA	
Size: B	HW Number: HW10481
Rev: A	Engineer: Shuang Zheng
Sheet: 1	Date: 08/29/2024

AT24C04C is a symbol of SOCKET for package

Assemble R146 and R148 when not assembling U20.

Assemble R147 and R149 when not assembling U19.

Assemble R144 and R145 when not assembling U20.

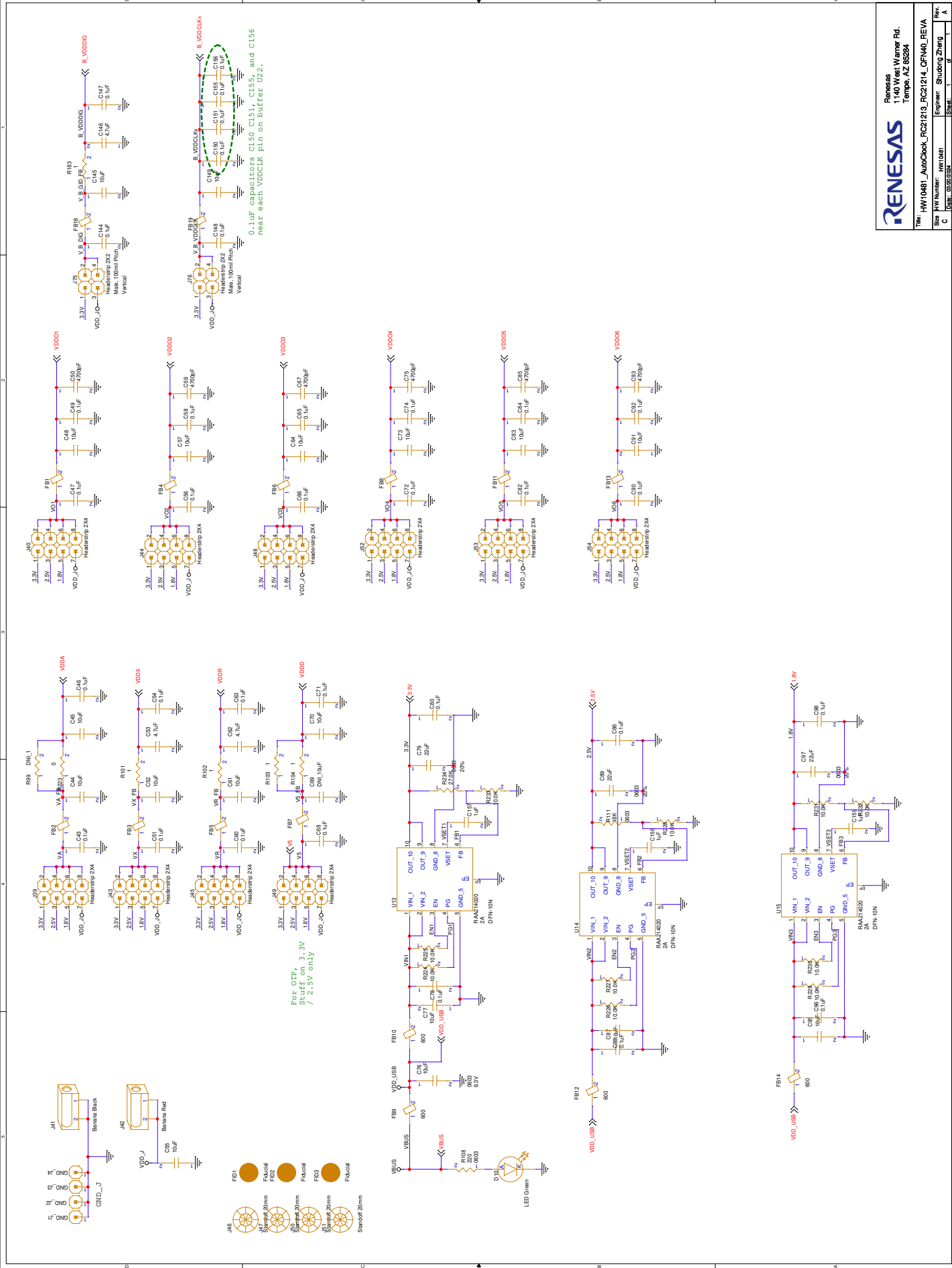

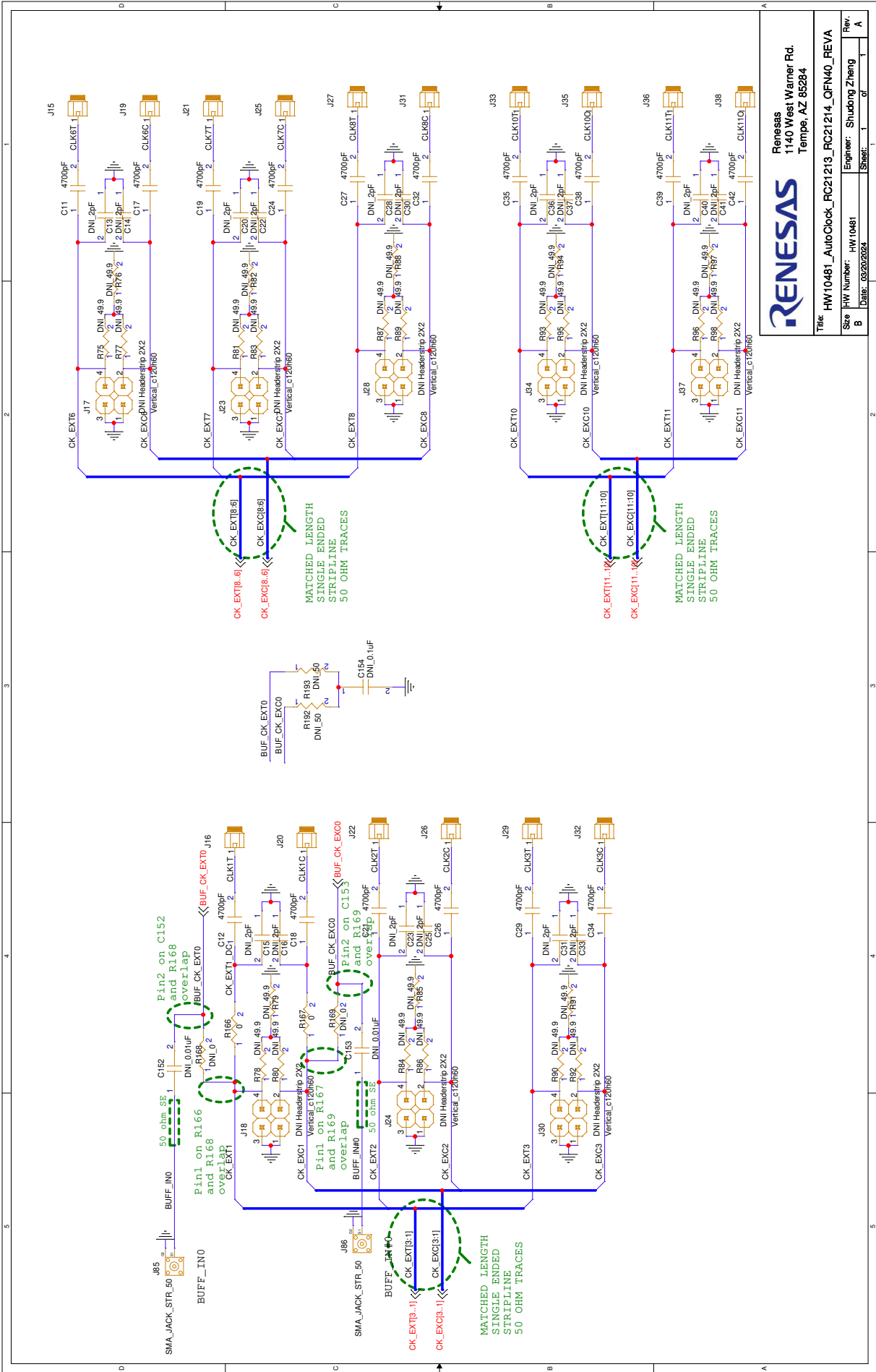

Renesas
1140 West Warner Rd.
Tempe, AZ 85284

Title: HW10481_AutoClock_RC21213_RC21214_QFN40_REVA	
Size: B	HW Number: HW10481
Rev: A	Engineer: Shuang Zheng
Sheet: 1	of 1

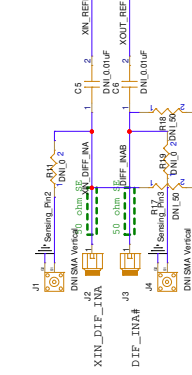
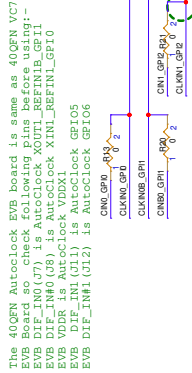
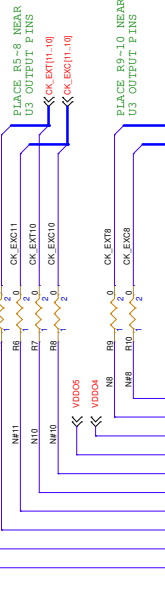
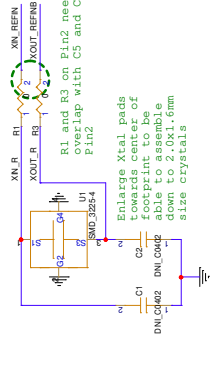

Inputs need to be stripline, and traces need to be 10 inches matched length

The 4QFN Autoclock EVB board is same as 4QFN VC7

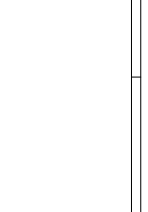
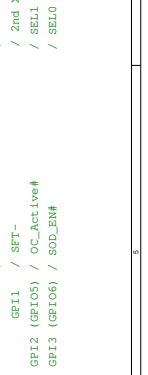
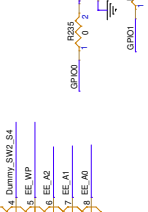
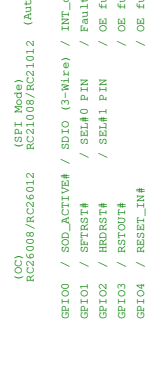
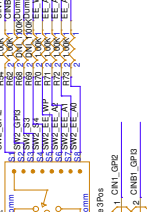
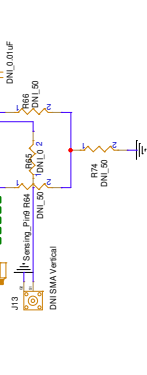
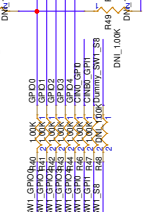
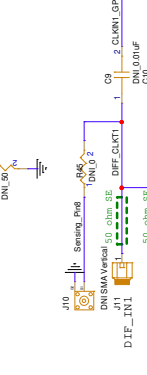
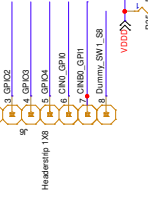
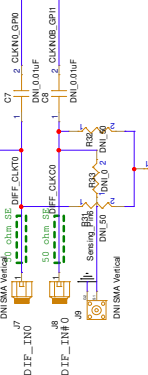

LED I5 is on SOT23-3 pin I5 high.

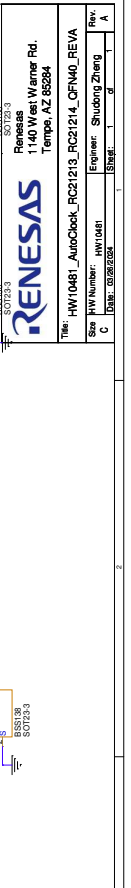

RC21012 (OC) RC21008/RC26012 (SDI Mode) RC21008/RC21012 (Auto-Clock)

- GPIO0 / SOD_ACTIVE# / SDO7 (3-Wire) / INT_output
- GPIO1 / SFT1# / SELF0 PIN / Fault_output
- GPIO2 / HDRST# / SELF1 PIN / OE function
- GPIO3 / RSTOUT# / OE function
- GPIO4 / RESET_IN# / OE function
- GPIO5 / SFT+ / 2nd Xc-1
- GPIO6 / SFT- / 2nd Xc-1
- GPIO7 (GPIO5) / OC_Active# / SEL1 function
- GPIO8 (GPIO6) / SOD_EN# / SEL0 function

RENEASIS
 HW/0481 AutoClock_RC21012_CPC21014_CPN40_REV A
 Rev. A

HW/0481 AutoClock_RC21012_CPC21014_CPN40_REV A
 Rev. A

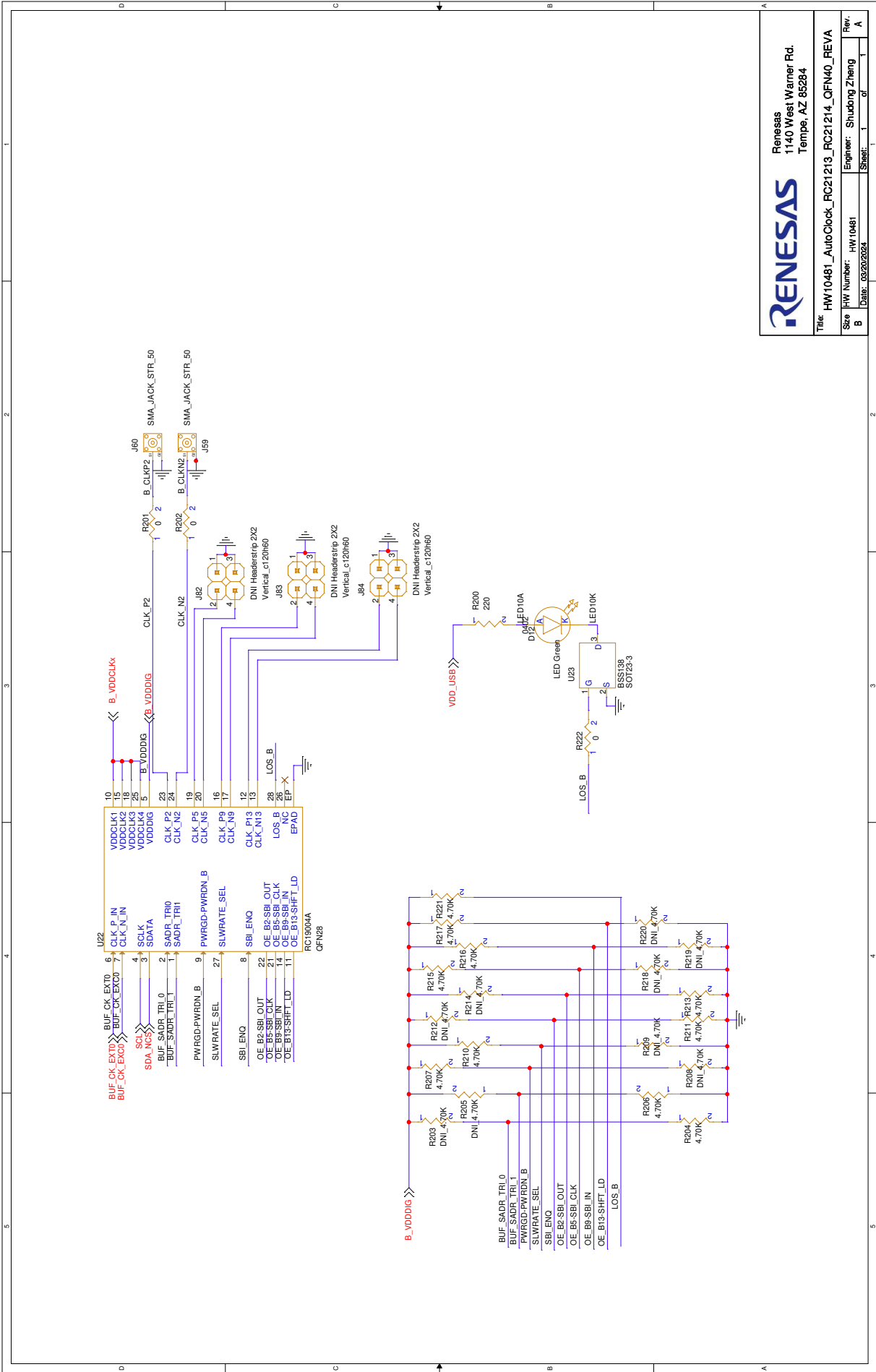

Renesas
1140 West Warner Rd.
Tempe, AZ 85284

Title: HW10481_AutoClock_RC21213_RC21214_QFN40_REVA		Rev.
Size: B	HW Number: HW10481	Engineer: Shudong Zheng
Date: 08/28/2024	Sheet: 1	of 1

FTDI Controls
I2C/SPI

Aardark Connector on pins 3, 4 and 6 for I2C control.

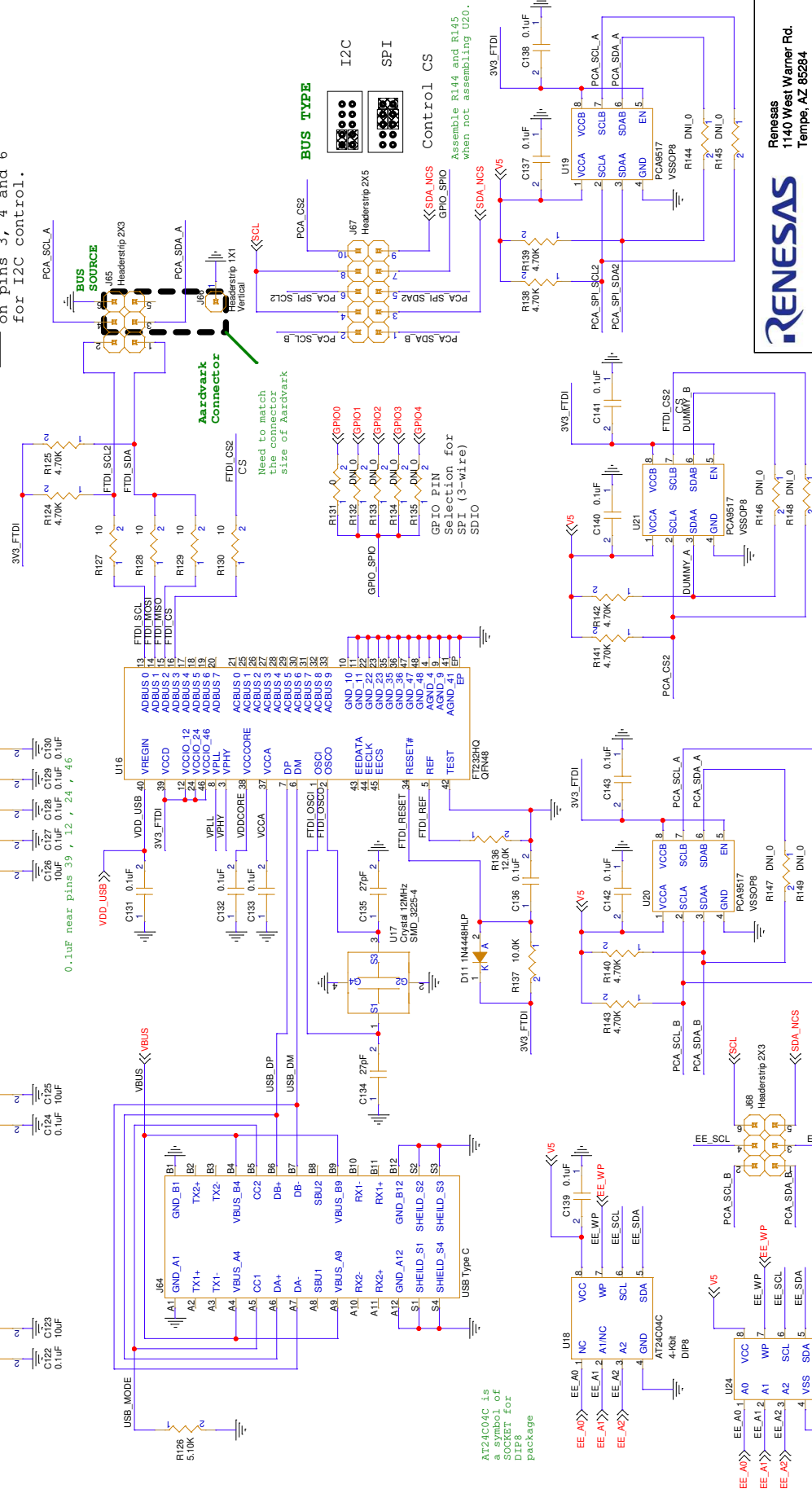

BUS TYPE



Control CS

Assemble R144 and R145 when not assembling U20.

Need to match the connector size of Aardark

GPIO PIN Selection for SPI (3-wire) SDIO

Assemble R146 and R148 when not assembling U20.

Assemble R147 and R149 when not assembling U19.



Renesas
1140 West Warner Rd.
Tempe, AZ 85284

Title: HW10480_AutoClock_RC21211_RC21212_QFN48_REVA	
Size: B	HW Number: HW10480
Sheet: 1	Engineer: Shuang Zheng
Rev: A	Date: 08/29/2024

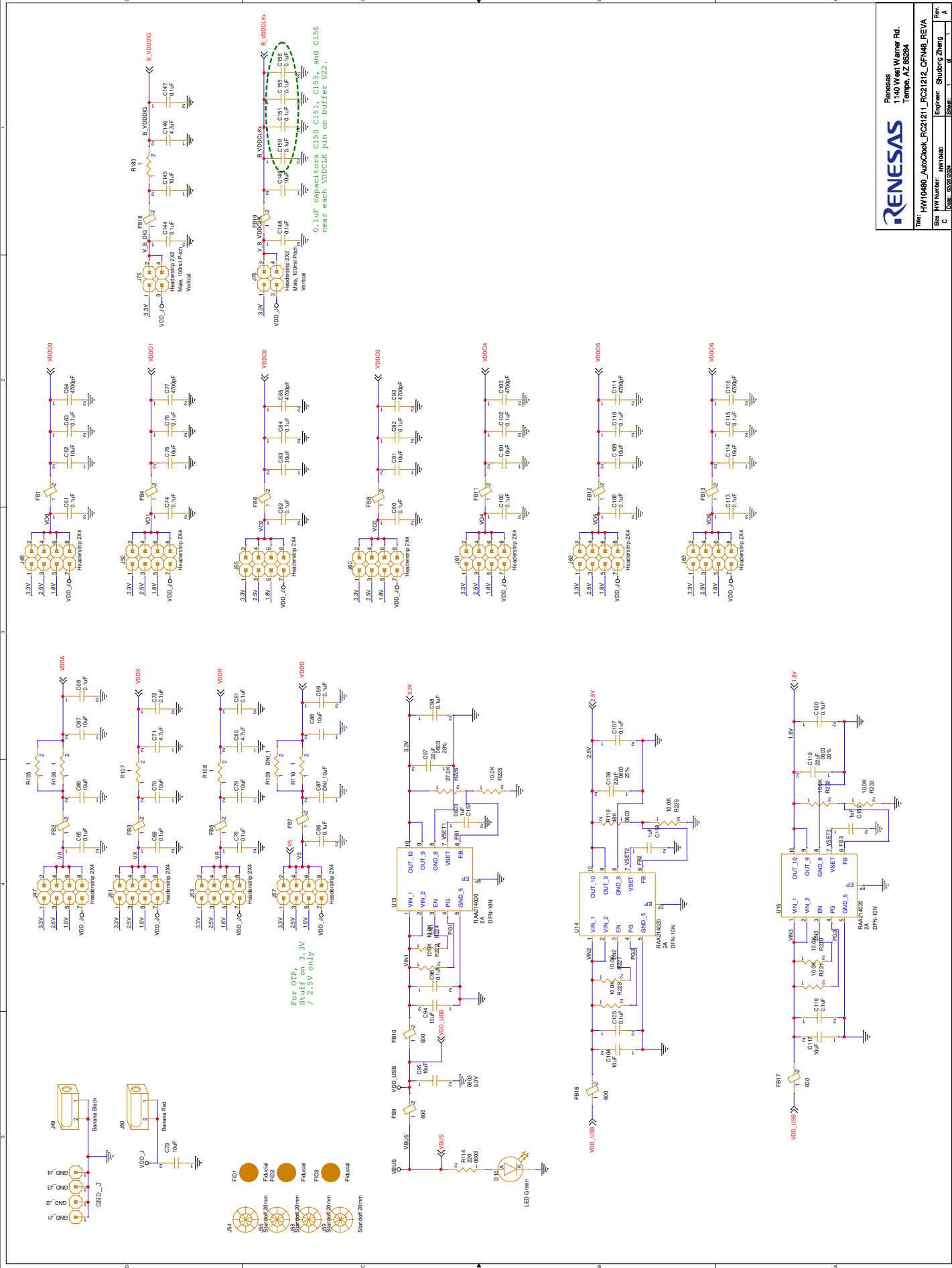

0.1uF capacitor, C150, C151, C155, and C156 near each VDDCLK pin on buffer U22.

For OTP, Stuff on 3.3V / 2.5V only

RENESAS
 Renesas
 1-140 West Warner Rd.
 Tempe, AZ 85284

HW10480_AutoClock_FC21211_OPN48_REV1A

Rev	A
Drawn	Shuang Zheng
Checked	
Approved	

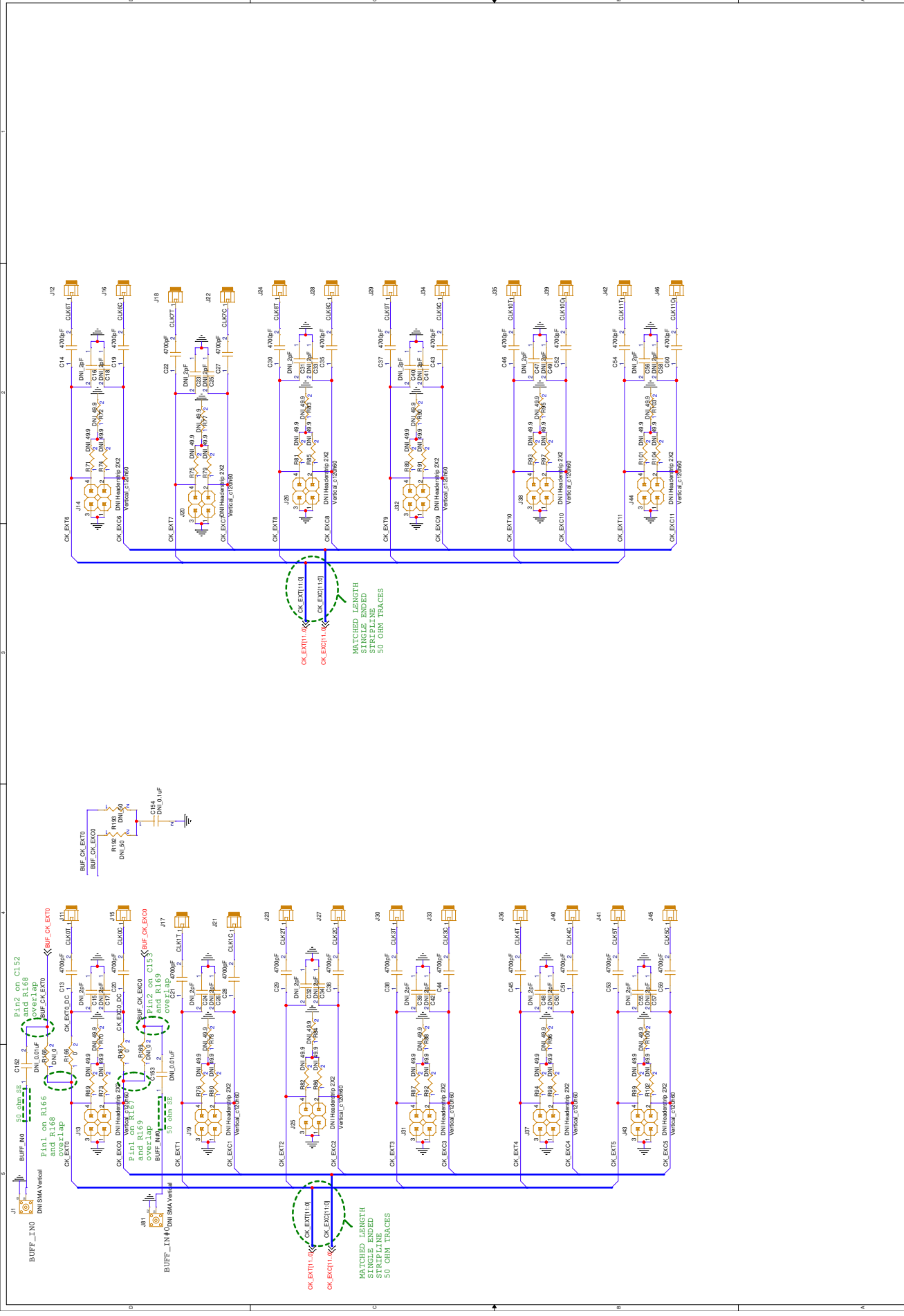

CK_EX110
CK_EX111
CK_EX110
CK_EX111

MATCHED LENGTH
SINGLE ENDED
STRAPLINE
50 OHM FRANCES

MATCHED LENGTH
SINGLE ENDED
STRAPLINE
50 OHM FRANCES

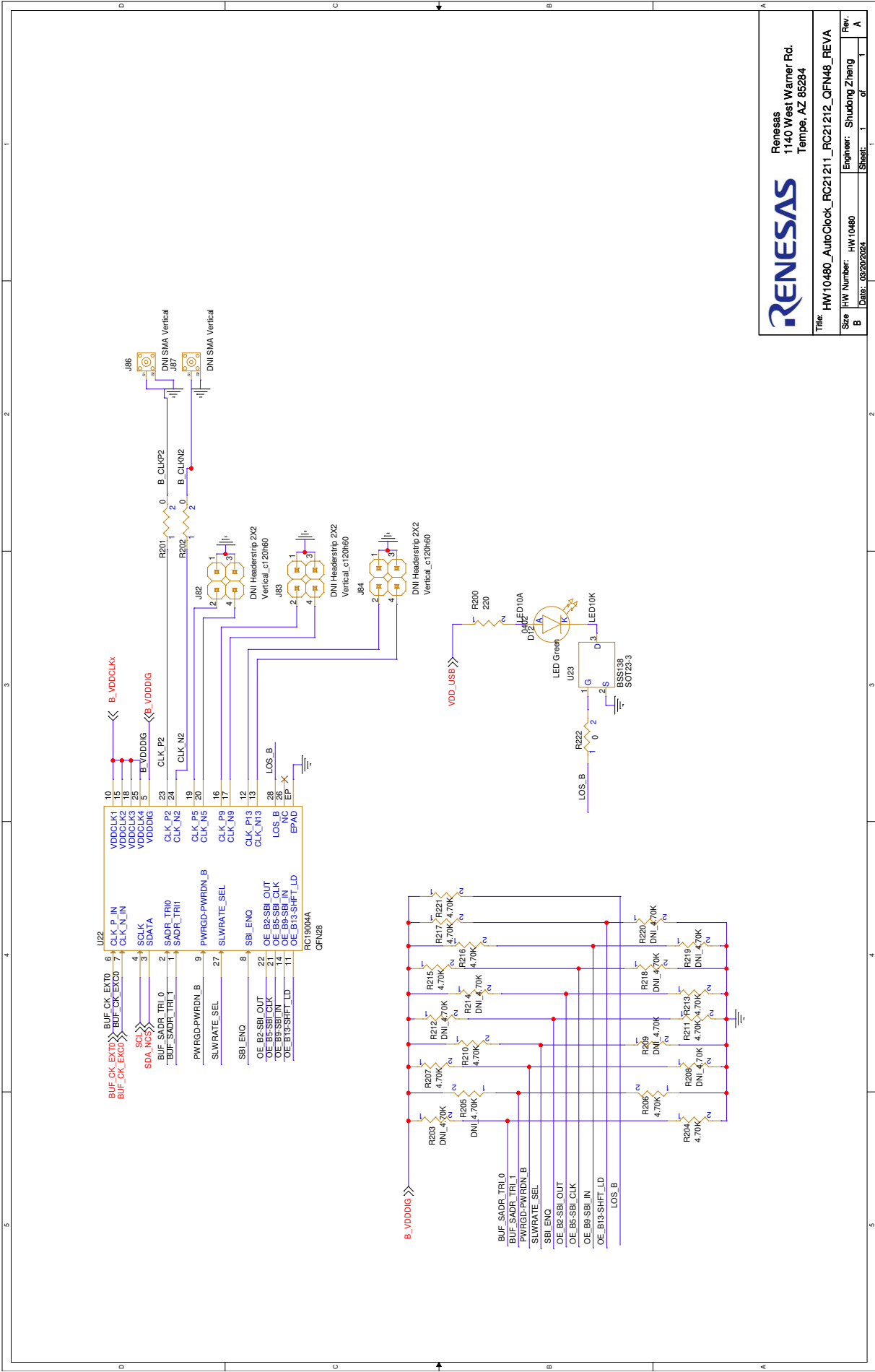

Renesas
1140 West Warner Rd.
Tempe, AZ 85284

Title: HW10480_AutoClock_RC21211_RC21212_OFN48_REVA		Rev. A
Size: B	HW Number: HW10480	Engineer: Shudong Zheng
Date: 08/28/2024	Sheet: 1	of 1

IMPORTANT NOTICE AND DISCLAIMER

RENESAS ELECTRONICS CORPORATION AND ITS SUBSIDIARIES (“RENESAS”) PROVIDES TECHNICAL SPECIFICATIONS AND RELIABILITY DATA (INCLUDING DATASHEETS), DESIGN RESOURCES (INCLUDING REFERENCE DESIGNS), APPLICATION OR OTHER DESIGN ADVICE, WEB TOOLS, SAFETY INFORMATION, AND OTHER RESOURCES “AS IS” AND WITH ALL FAULTS, AND DISCLAIMS ALL WARRANTIES, EXPRESS OR IMPLIED, INCLUDING, WITHOUT LIMITATION, ANY IMPLIED WARRANTIES OF MERCHANTABILITY, FITNESS FOR A PARTICULAR PURPOSE, OR NON-INFRINGEMENT OF THIRD-PARTY INTELLECTUAL PROPERTY RIGHTS.

These resources are intended for developers who are designing with Renesas products. You are solely responsible for (1) selecting the appropriate products for your application, (2) designing, validating, and testing your application, and (3) ensuring your application meets applicable standards, and any other safety, security, or other requirements. These resources are subject to change without notice. Renesas grants you permission to use these resources only to develop an application that uses Renesas products. Other reproduction or use of these resources is strictly prohibited. No license is granted to any other Renesas intellectual property or to any third-party intellectual property. Renesas disclaims responsibility for, and you will fully indemnify Renesas and its representatives against, any claims, damages, costs, losses, or liabilities arising from your use of these resources. Renesas' products are provided only subject to Renesas' Terms and Conditions of Sale or other applicable terms agreed to in writing. No use of any Renesas resources expands or otherwise alters any applicable warranties or warranty disclaimers for these products.

(Disclaimer Rev.1.01 Jan 2024)

Corporate Headquarters

TOYOSU FORESIA, 3-2-24 Toyosu,
Koto-ku, Tokyo 135-0061, Japan
www.renesas.com

Trademarks

Renesas and the Renesas logo are trademarks of Renesas Electronics Corporation. All trademarks and registered trademarks are the property of their respective owners.

Contact Information

For further information on a product, technology, the most up-to-date version of a document, or your nearest sales office, please visit www.renesas.com/contact-us/.