

Introduction

The ISL6268EVAL1Z evaluation board demonstrates the performance of the ISL6268HZ single-phase synchronous-buck PWM controller featuring Intersil's Robust Ripple Regulator (R³) technology. The evaluation DC/DC converter design criteria is located in Table 1. An on-board dynamic-load generator is included for evaluating the transient-load response. The dynamic-load applies a 2.5ms pulse of 250mΩ across VOUT and GND every 30ms. Contents of this document include:

- Recommended Test Equipment
- Interface Connections
- Switch Descriptions
- Jumper Descriptions
- Test Point Descriptions
- Typical Waveforms
 - Start-up
 - Shut-down
 - Diode-emulation
 - Load-transient response
 - Line-transient response
 - Overvoltage protection
 - Undervoltage protection
 - Overcurrent protection
- Evaluation Board Documentation
 - Schematic
 - Bill of materials
 - Silk-screen plots
 - Board layer plots

TABLE 1. DC/DC DESIGN CRITERIA

| PARAMETER | VALUE | UNITS |
|---------------|---------|-------|
| VIN | 7 to 25 | VDC |
| VOUT | 1.20 | VDC |
| FULL-LOAD | 5.0 | ADC |
| PWM FREQUENCY | 300 | kHz |

Recommended Equipment

- (QTY 1) Adjustable 25V, 3A Power Supply
- (QTY 1) Fixed 12V, 100mA Power Supply
- (QTY 1) Fixed 5V, 100mA Power Supply
- (QTY 1) Adjustable 10A Constant Current Electronic Load
- (QTY 1) DVM
- (QTY 1) Four Channel Oscilloscope

Interface Connections

- VIN: Input voltage to the power stage of the converter
 - J1: VIN positive power input
 - TP1: VIN positive voltage sense
 - J2: VIN return power input
 - TP2: VIN return voltage sense
- VOUT: Regulated output voltage from the converter
 - J3: VOUT positive power output
 - TP3: VOUT positive voltage sense
 - J4: VOUT return power output
 - TP4: VOUT return voltage sense
- VCC: +5V input voltage for VCC, PVCC, PGOOD-LED and pull-up voltage rail
 - J5: 5V positive input
 - J6: 5V return input
- +12V: Input voltage for the dynamic-load generator
 - J7: 12V positive input
 - J8: 12V return input

Switch Descriptions

- S1: ENABLE
 - OFF: Shorts the EN pin to GND (disable PWM)
 - ON: Allows the EN pin to pull-up to +5V (enable PWM)
- S2: DYNAMIC LOAD
 - OFF: Load disabled
 - ON: Load enabled

Jumper Descriptions

- JP1: Connects +5V supply to the PGOOD LED circuit. The shunt jumper is normally installed. Remove the shunt jumper when making low power efficiency measurements
- JP2: Isolates the EN pin from switch S1 so that it can be externally driven

Test-point Descriptions

- P1: Scope-probe socket for measuring the PHASE node
- P2: Scope-probe socket for measuring VOUT
- P3: Scope-probe socket for measuring voltage across the dynamic-load resistors (hence load current)
- TP5: Monitor the PGOOD pin
- TP6: Monitor or drive the EN pin
- TP7: Monitor the COMP pin (SENSITIVE!)
- TP8: Monitor the FB pin (SENSITIVE!)
- TP9: Monitor the FSET pin
- TP10: Monitor the PVCC pin
- TP11 to TP16: Signal Ground

Typical Waveforms

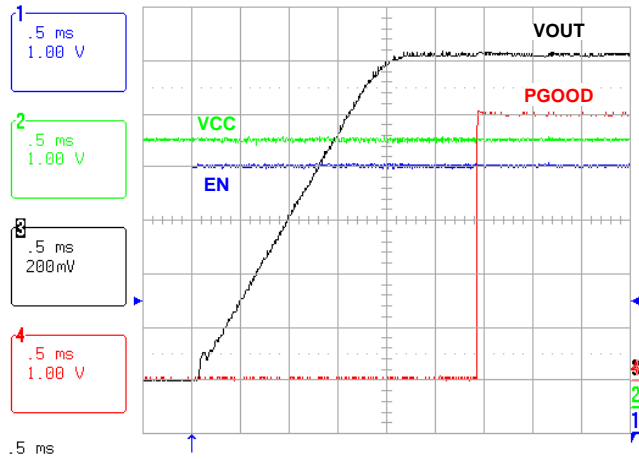

FIGURE 1. SOFT-START: NO LOAD

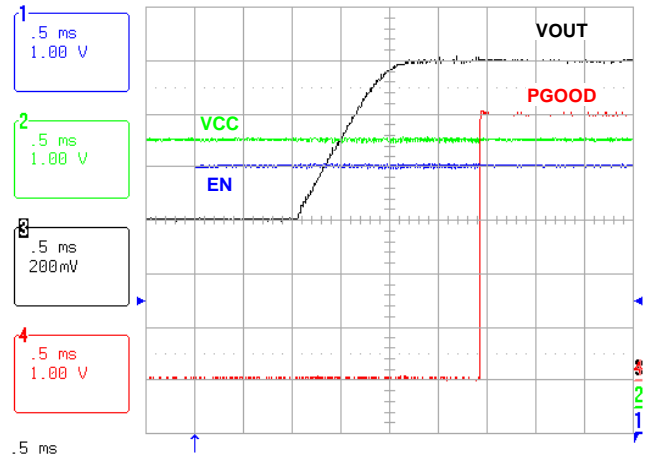

FIGURE 2. SOFT-START: NO LOAD, 50% VOUT-PREBIAS

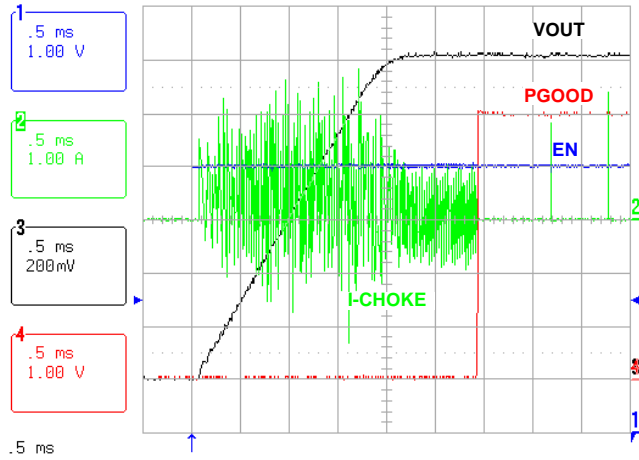

FIGURE 3. IN-RUSH CURRENT: NO LOAD

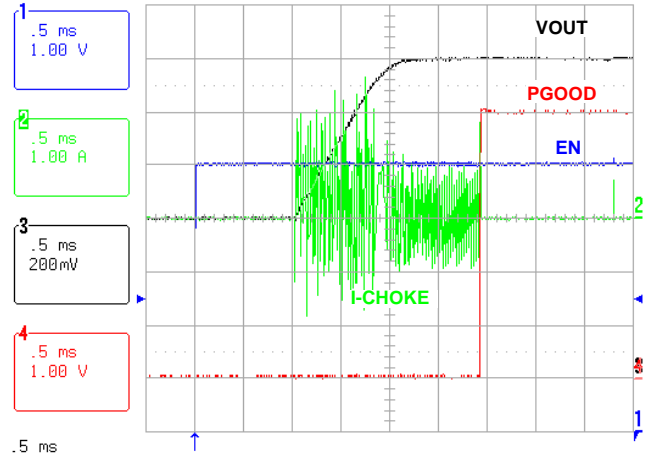

FIGURE 4. IN-RUSH CURRENT: NO LOAD, 50% VOUT-PREBIAS

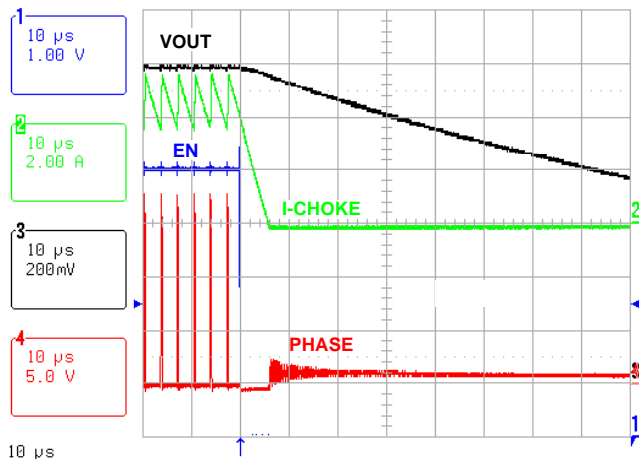

FIGURE 5. SHUTDOWN: EN FALLING, 250mΩ LOAD

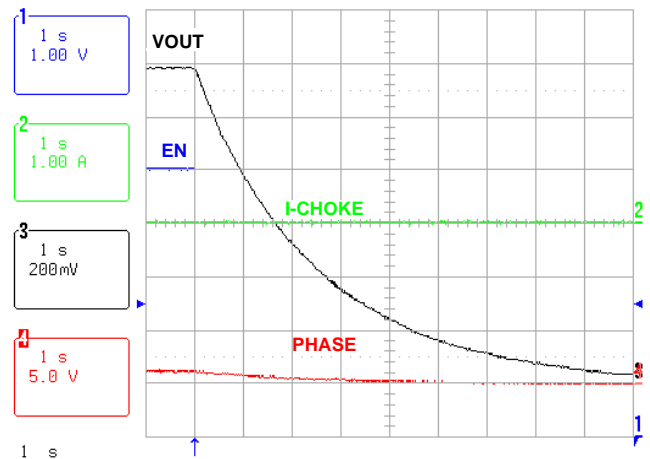

FIGURE 6. SHUTDOWN: EN FALLING, NO LOAD

Typical Waveforms (Continued)

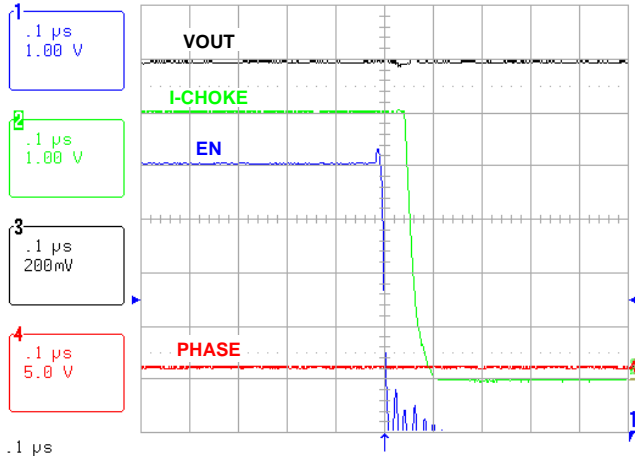

FIGURE 7. SHUTDOWN: EN-FALLING TO PGOOD-FALLING, NO LOAD

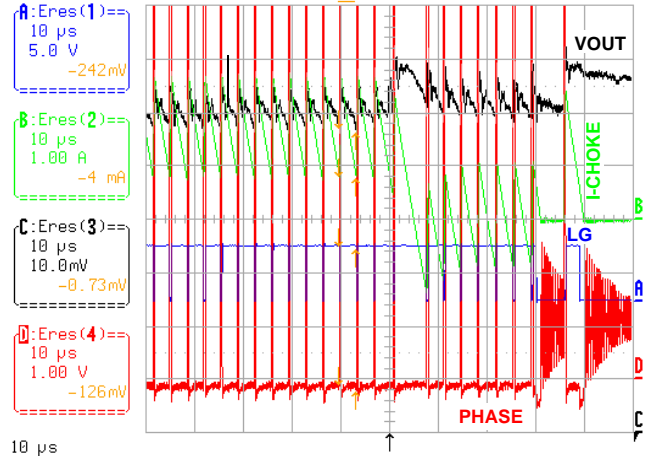

FIGURE 8. ENTERING DEM: 750mΩ LOAD DUMP, 100mA DC STATIC LOAD

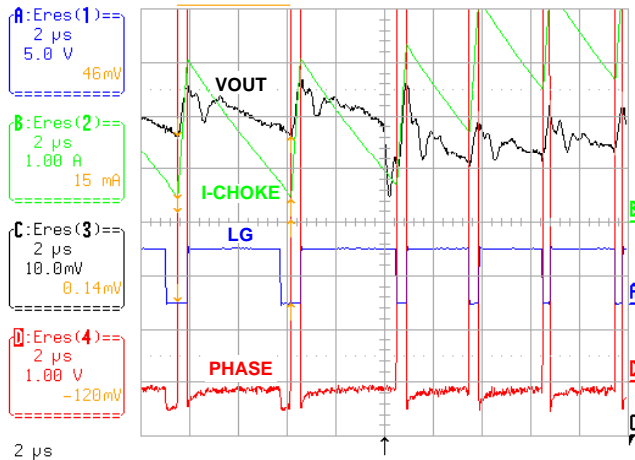

FIGURE 9. EXITING DEM: 750mΩ LOAD STEP, 1.75A DC STATIC LOAD

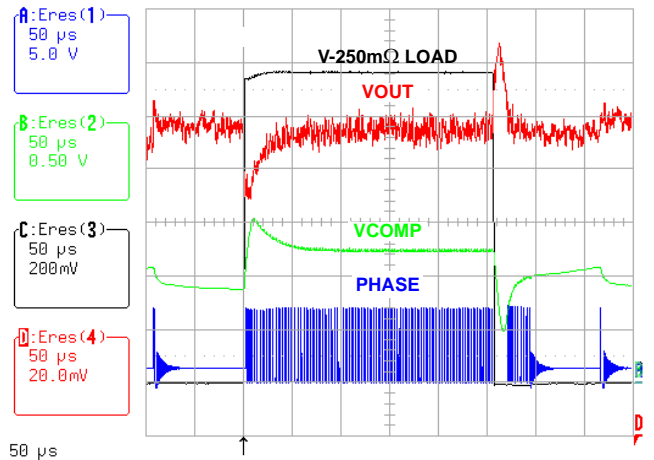

FIGURE 10. LOAD TRANSIENT: 250mΩ LOAD STEP, 10mA DC STATIC LOAD

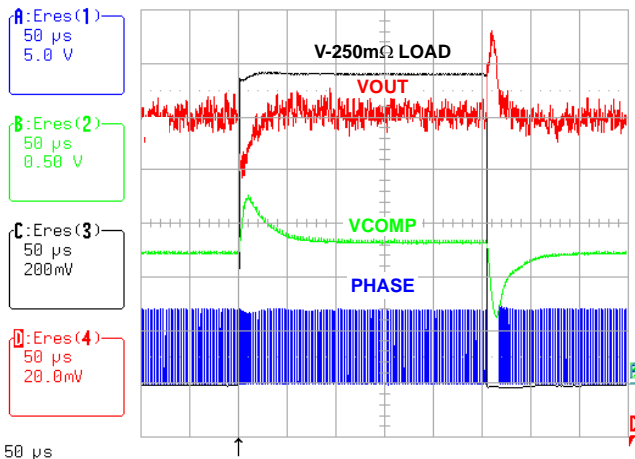

FIGURE 11. LOAD TRANSIENT: 250mΩ LOAD STEP, 5A DC STATIC LOAD

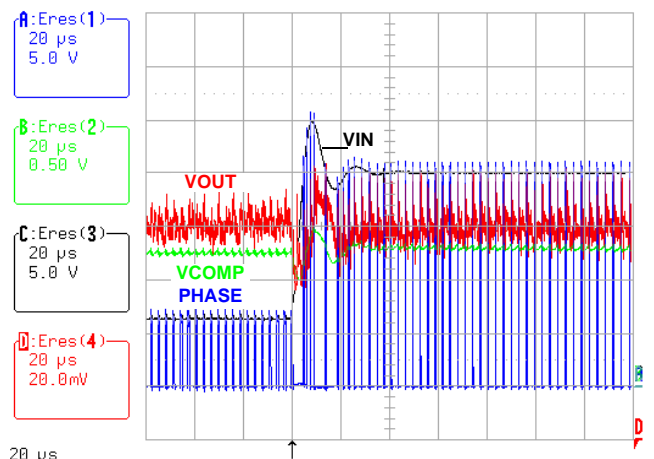
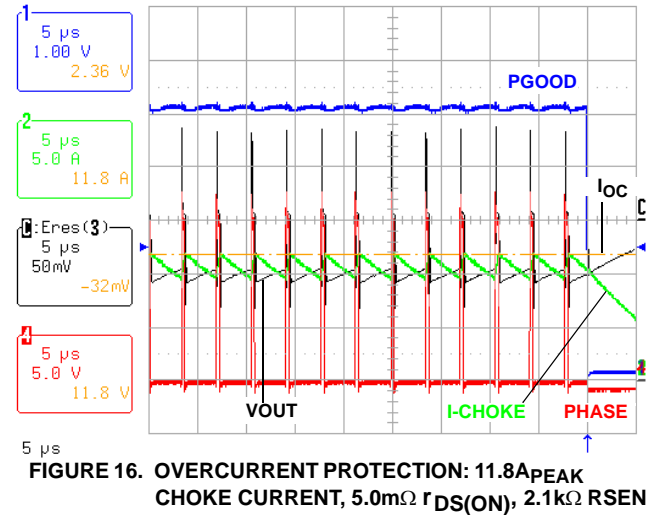
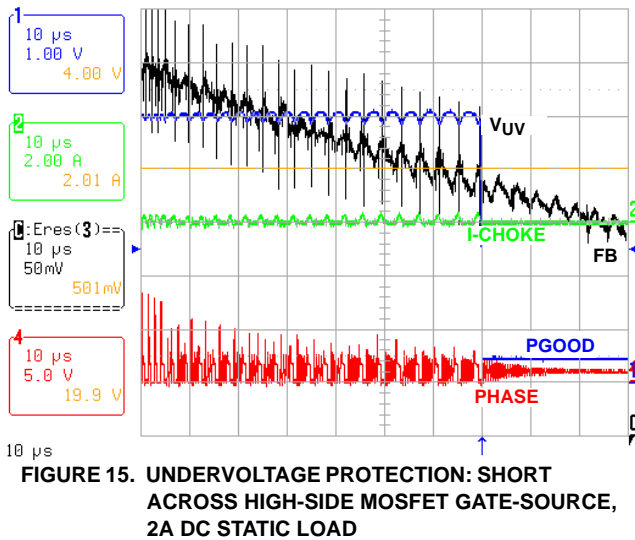
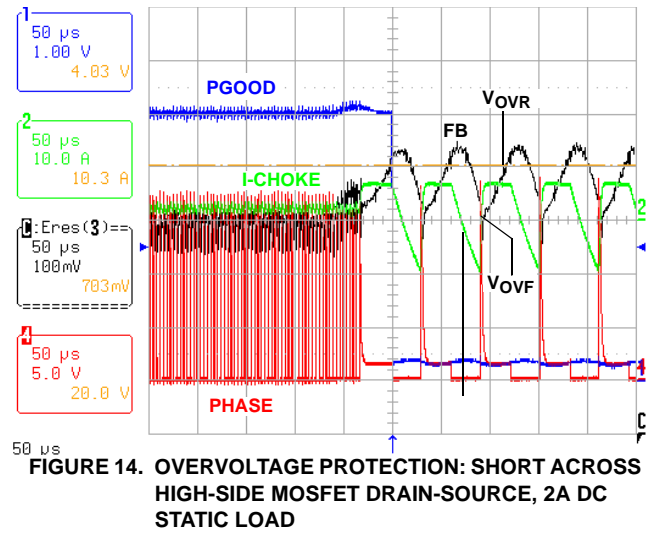
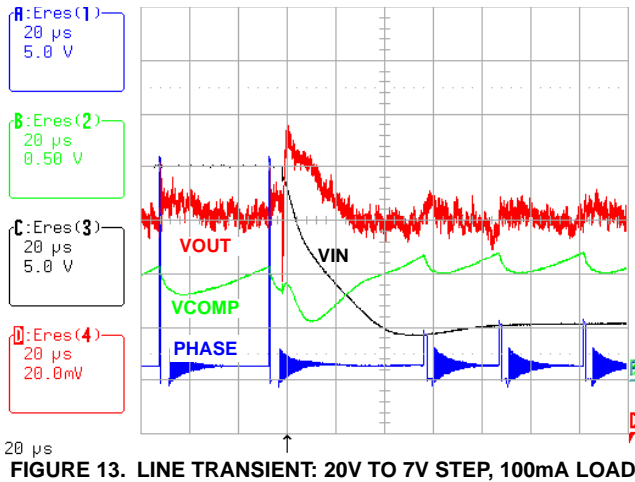

FIGURE 12. LINE TRANSIENT: 7V TO 20V STEP, 5A LOAD

Typical Waveforms (Continued)



The value of the OCP overcurrent programming resistor R_{SEN} is calculated using Equation 1:

$$R_{SEN} = \frac{(I_{FL} + \frac{I_{PP}}{2}) \cdot OC_{SP} \cdot r_{DS(ON)}}{I_{OC}} \quad (EQ. 1)$$

where:

- r_{DS(ON)} is the on-state resistance of the low-side MOSFET
 - I_{OC} is the I_{SEN} threshold current that trips the OCP circuit
 - I_{FL} is the maximum continuous design load current
 - I_{PP} is the inductor peak-to-peak ripple current
 - OC_{SP} is the desired OCP setpoint multiplier relative to I_{FL}
- The ISL6268EVAL1Z delivers 5A I_{FL} with approximately 30% inductor ripple current (1.5A_{p-p}). The low-side MOSFET has 5mΩ r_{DS(ON)}. The OCP setpoint should be chosen to avoid nuisance tripping due to component tolerances and temperature effects. The ISL6268EVAL1Z is programmed to 190% (OC_{SP} = 1.9). Using Equation 1 finds R_{SEN} = 2.1kΩ.

The value of the frequency programming resistor R_{FSET} is calculated using Equation 2:

$$R_{FSET} = \frac{1}{K \cdot f_{SW}} \quad (EQ. 2)$$

where:

- f_{SW} is the PWM switching frequency
- K = 66 × 10⁻¹²

The ISL6268EVAL1Z is programmed for 300kHz. Using Equation 2 finds R_{FSET} = 49.9kΩ.

The regulation voltage setpoint programming resistors R_{TOP} and R_{BOTTOM} are calculated using Equation 3:

$$V_{REF} = V_{OUT} \cdot \frac{R_{BOTTOM}}{R_{TOP} + R_{BOTTOM}} \quad (EQ. 3)$$

where:

- V_{REF} = 600mV

The ISL6268EVAL1Z is programmed for 1.20V, therefore, R_{TOP} = R_{BOTTOM}. The loop compensation is usually responsible for selecting R_{TOP}, which in this case is 2.49kΩ.

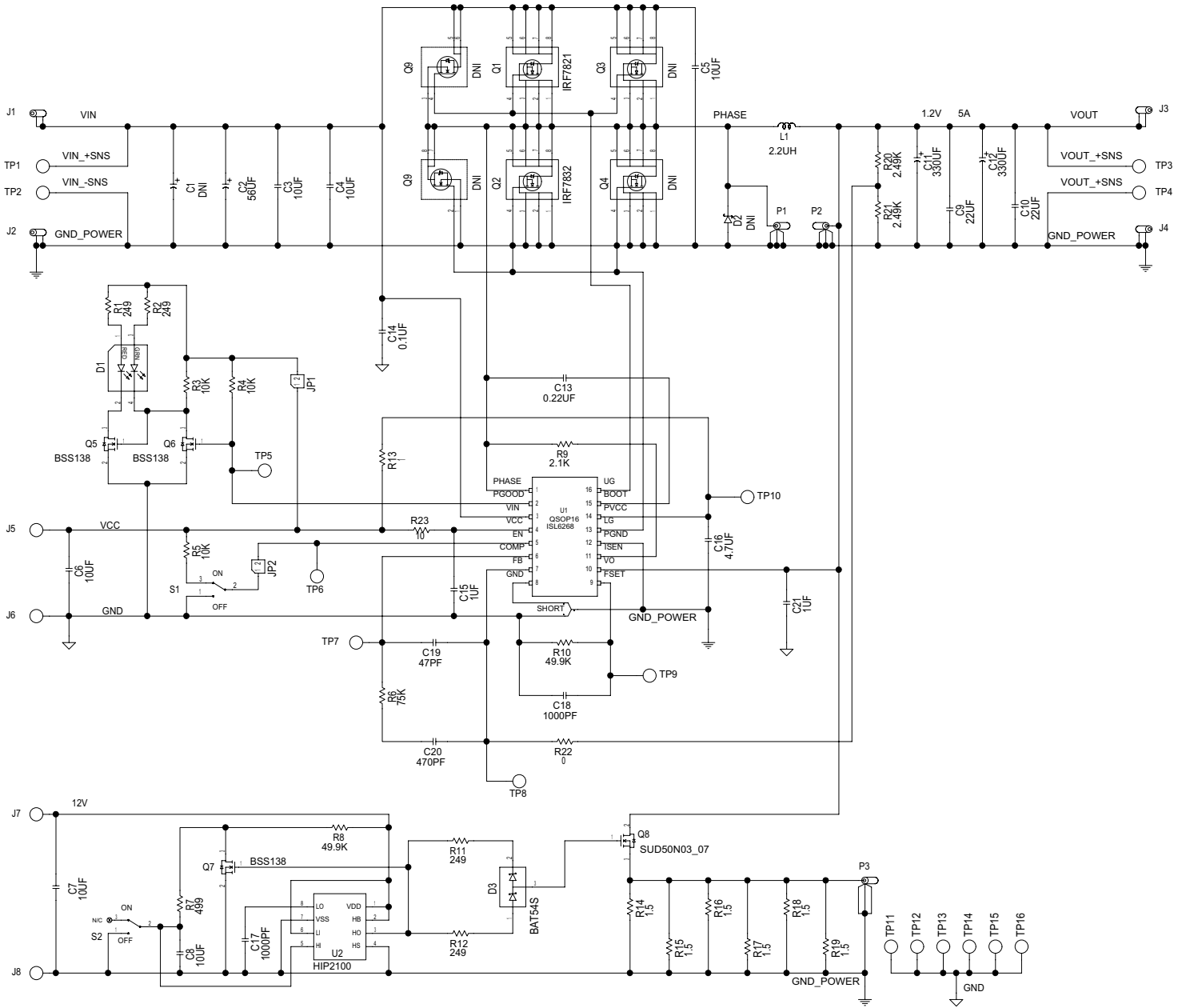

FIGURE 17. ISL6268EVAL1Z REV B CIRCUIT SCHEMATIC

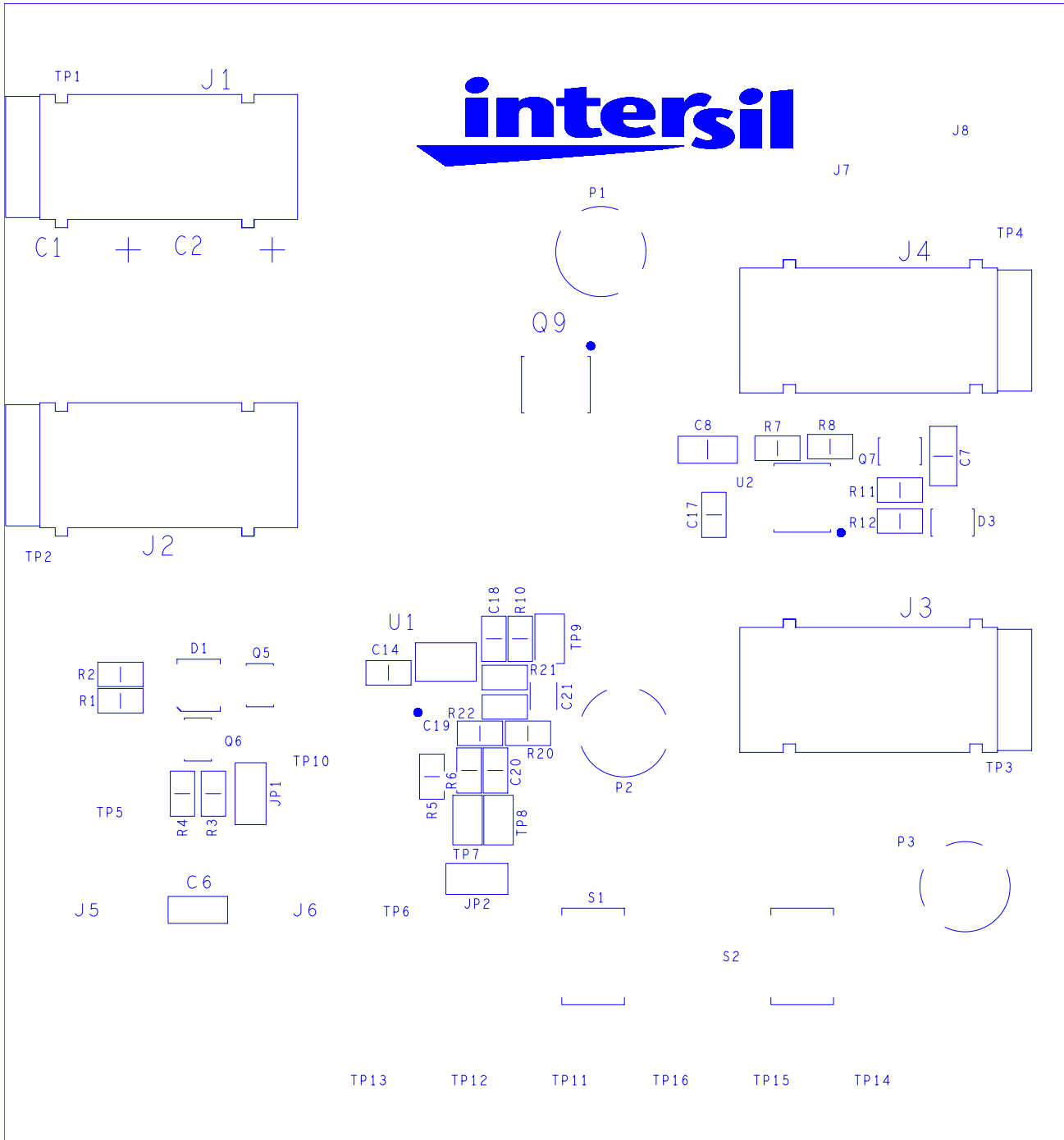

FIGURE 18. PCB TOP SILK SCREEN

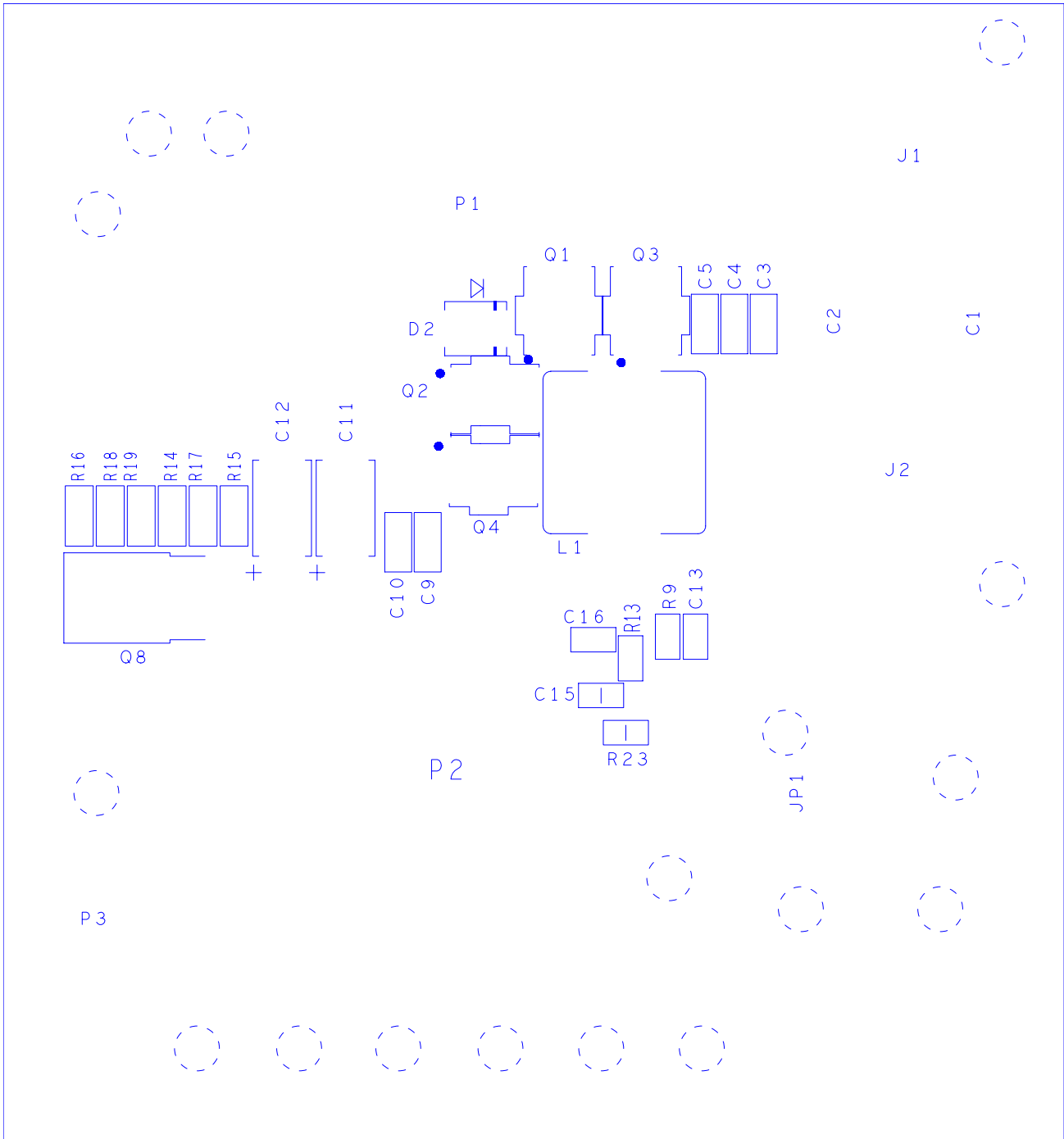

FIGURE 19. PCB BOTTOM SILK SCREEN (MIRRORED)

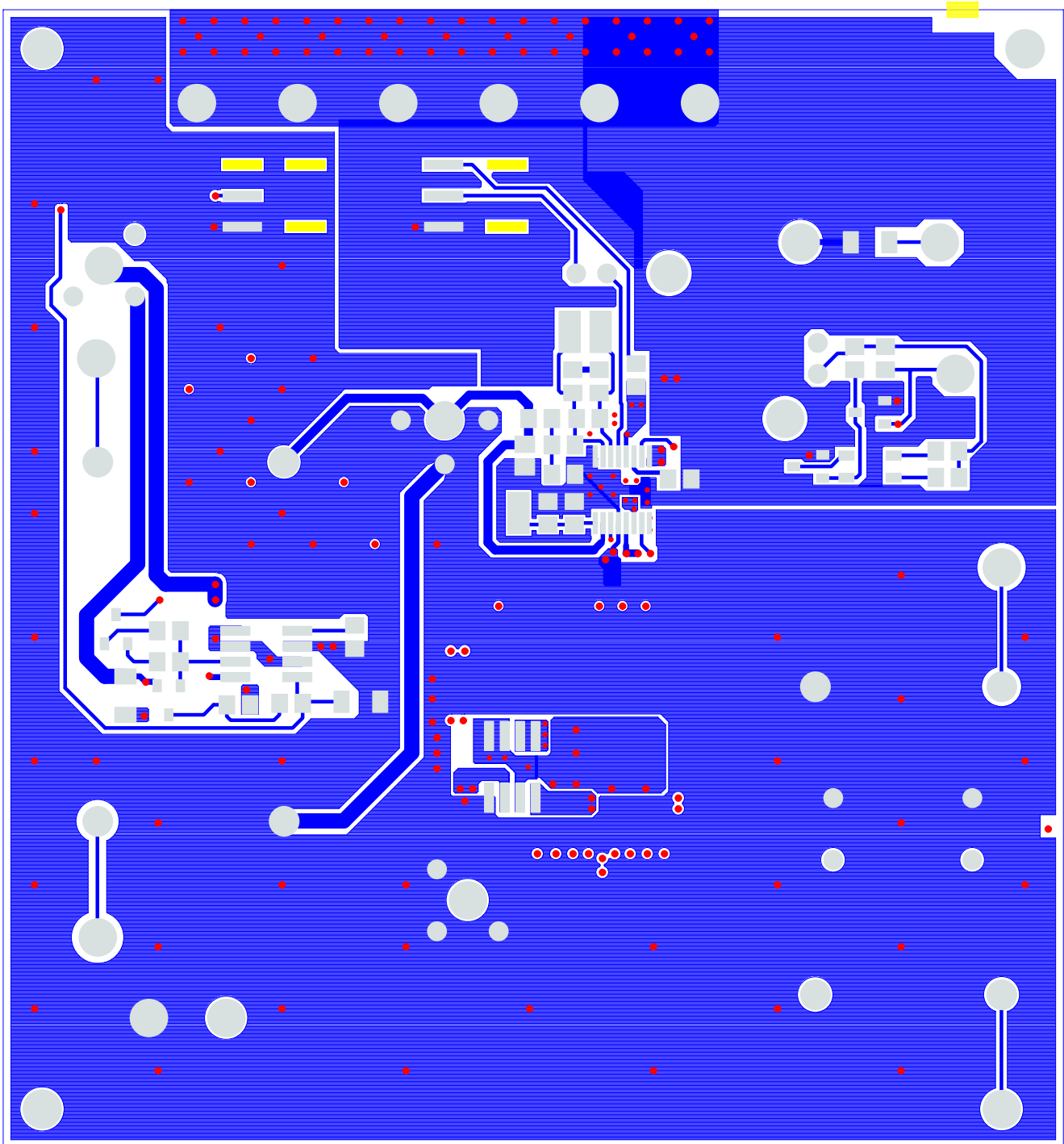

FIGURE 20. PCB TOP LAYER ETCH

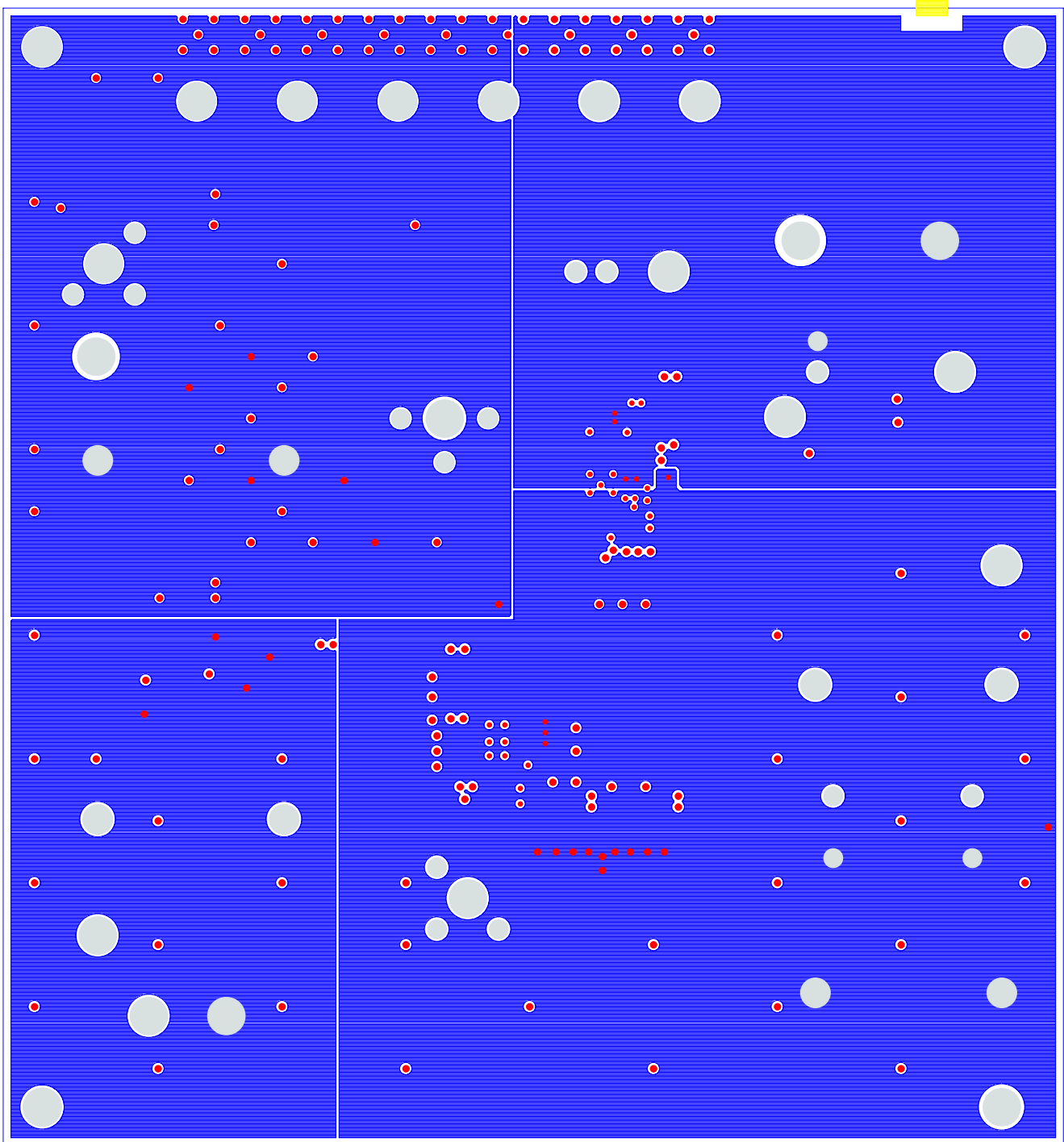

FIGURE 21. PCB LAYER 2 ETCH

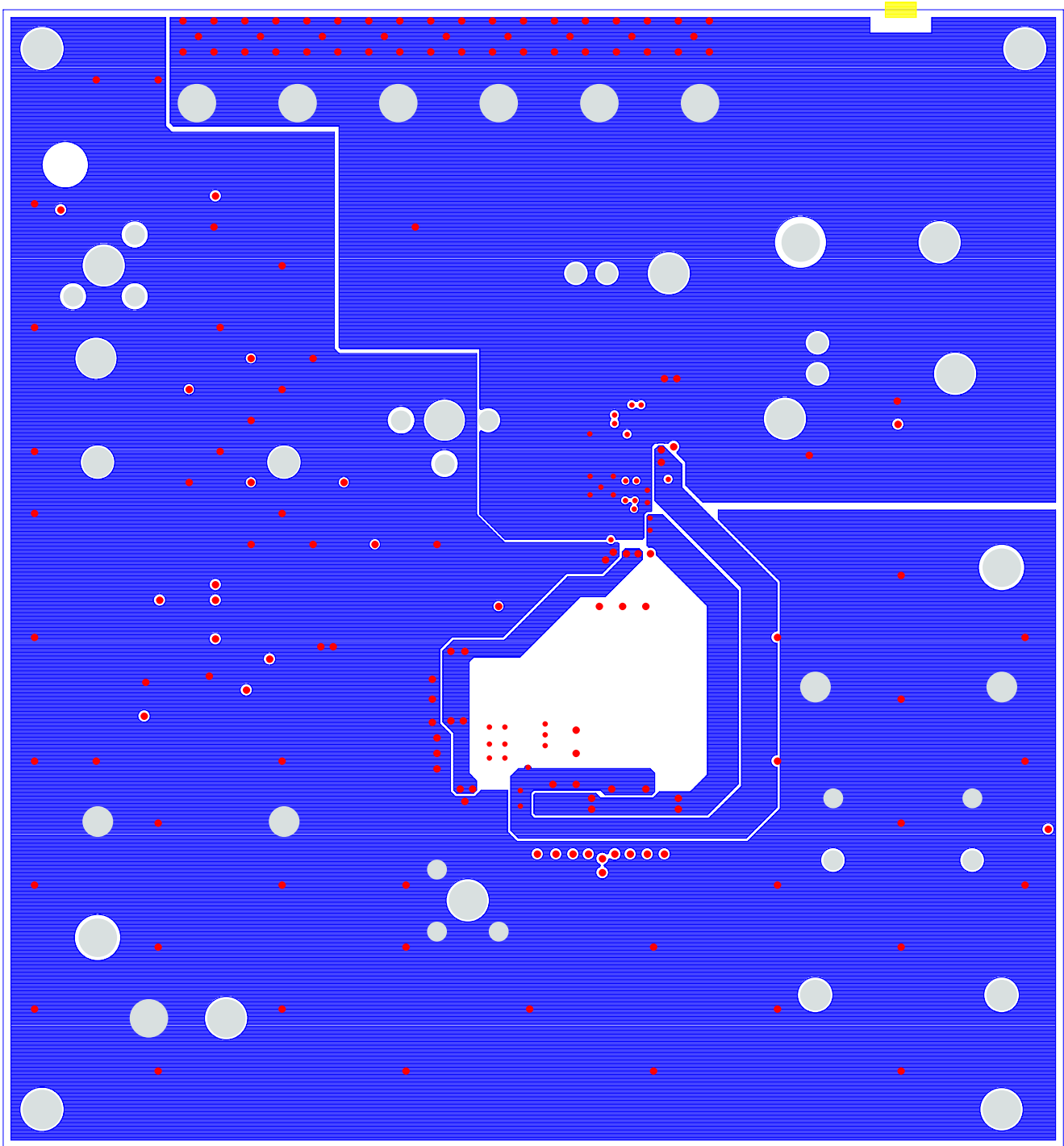

FIGURE 22. PCB LAYER 3 ETCH

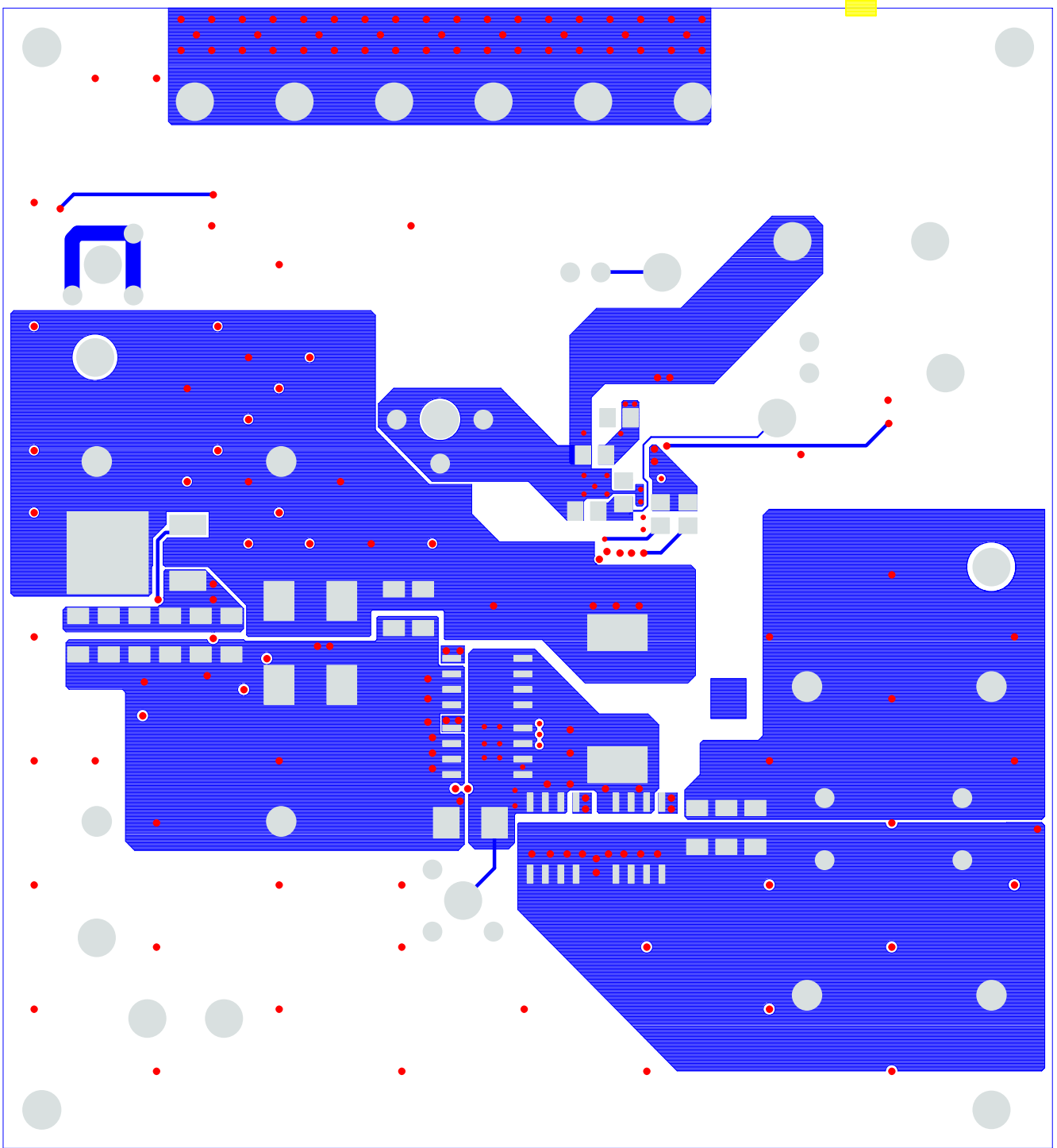

FIGURE 23. PCB BOTTOM LAYER ETCH

Application Note 1274

Bill of Materials

| QTY | REFERENCE | DESCRIPTION/COMMENT | MFG NAME | MFG NUMBER |
|-----|--------------------------------|---|-----------|---------------------|
| 1 | C2 | CAP, RADIAL, 56 μ F, 25V, OSCON | SANYO | 25SP56M |
| 2 | C11, C12 | CAP, SMD, [7.3mmx4.3mm], 330 μ F, 2V, 7m Ω , 20%, SP-CAP | PANASONIC | EEF-SD0D331R |
| 1 | C13 | CAPACITOR, 0805, 0.22 μ F, 16V, 20%, X7R | GENERIC | NA |
| 1 | C14 | CAPACITOR, 0805, 0.1 μ F, 50V, 20%, X7R | GENERIC | NA |
| 2 | C15, C21 | CAPACITOR, 0805, 1 μ F, 6.3V, 20%, X5R | GENERIC | NA |
| 1 | C16 | CAPACITOR, 0805, 4.7 μ F, 6.3V, 20%, X5R | GENERIC | NA |
| 2 | C17, C18 | CAPACITOR, 0805, 1000pF, 50V, 10%, X7R | GENERIC | NA |
| 1 | C19 | CAPACITOR, 0805, 47pF, 50V, 5%, X7R | GENERIC | NA |
| 1 | C20 | CAPACITOR, 0805, 470pF, 50V, 5%, X7R | GENERIC | NA |
| 2 | C9, C10 | CAPACITOR, 1206, 22 μ F, 6.3V, 20%, X5R | GENERIC | NA |
| 6 | C3 to C8 | CAPACITOR, 1206, 10 μ F, 25V, 20%, X5R | GENERIC | NA |
| 1 | D1 | LED, SMD, 3mmx2.5mm, 4P, RED/GREEN, 12/20MCD, 2V | LUMEX | SSL-LXA3025IGC-TR |
| 1 | D3 | DIODE, SCHOTTKY, DUAL, SOT23, 30V, 200mA | ON-SEMI | BAT54S |
| 3 | TP7, TP8, TP9 | TEST-POINT, SMD, 0.070x0.135 PAD | KEYSTONE | MTP5015SM |
| 2 | J1, J3 | PLUG, BANANA, THRU-HOLE, RED, 4.23mm | MOUSER | 164-6219 |
| 2 | J2, J4 | PLUG, BANANA, THRU-HOLE, BLK, 4.23mm | MOUSER | 164-6218 |
| 4 | J5, J7, TP1, TP3 | TEST-POINT, VERTICAL, RED | KEYSTONE | CTP5005 |
| 10 | J6, J8, TP2, TP4, TP11 to TP16 | TEST-POINT, VERTICAL, BLACK | KEYSTONE | CTP5006 |
| 3 | TP5, TP6, TP10 | TEST-POINT, VERTICAL, WHITE | KEYSTONE | CTP5007 |
| 2 | JP1, JP2 | HEADER, 1x2, RETENTIVE, 2.54mm | FCI | 68000-236 |
| 1 | L1 | INDUCTOR, SMD, 13mm, 2.2 μ H, 20%, 29A, SHIELDED | VISHAY | IHLP-5050CE-01-2R2M |
| 1 | Q1 | MOSFET, N-CH, SMD, 8P, SO8, 30V, 9.5m Ω | IR | IRF7821 |
| 1 | Q2 | MOSFET, N-CH, SMD, 8P, SO8, 30V, 4m Ω | IR | IRF7832 |
| 3 | Q5-Q7 | MOSFET, N-CH, SMD, 3P, SOT23, 50V, 200mA | FAIRCHILD | BSS138LT1 |
| 1 | Q8 | MOSFET, N-CH, SMD, TO-252AA, 30V, 7m Ω | SILICONIX | SUD50N03-07 |
| 4 | R1, R2, R11, R12 | RESISTOR, 0805, 249 Ω , 1% | GENERIC | NA |
| 2 | R8, R10 | RESISTOR, 0805, 49.9k Ω , 1% | GENERIC | NA |
| 1 | R13 | RESISTOR, 0805, 1 Ω , 5% | GENERIC | NA |
| 6 | R14 to R19 | RESISTOR, 1206, 1.5 Ω , 1% | GENERIC | NA |
| 1 | R22 | RESISTOR, 0805, 1k Ω , 1% | GENERIC | NA |
| 3 | R3 to R5 | RESISTOR, 0805, 10k Ω , 1% | GENERIC | NA |
| 1 | R6 | RESISTOR, 0805, 75k Ω , 1% | GENERIC | NA |
| 1 | R7 | RESISTOR, 0805, 499 Ω , 1% | GENERIC | NA |
| 1 | R9 | RESISTOR, 0805, 2.1k Ω , 1% | GENERIC | NA |
| 2 | R20, R21 | RESISTOR, 0805, 1.5k Ω , 1% | GENERIC | NA |
| 2 | S1, S2 | TOGGLE-SWITCH, SPDT, On-None-On, SMT | C&K | GT13MSCKE |
| 1 | U1 | IC, PWM-CONTROLLER, 1CH, 16P, SSOP | INTERSIL | ISL6268 |
| 1 | U2 | IC, DRIVER, BRIDGE, 8P, SOIC, 100V | INTERSIL | HIP2100B |
| | C1, D2, P1, P2, P3, Q3, Q4, Q9 | NOT POPULATED | | |

Intersil Corporation reserves the right to make changes in circuit design, software and/or specifications at any time without notice. Accordingly, the reader is cautioned to verify that the Application Note or Technical Brief is current before proceeding.

For information regarding Intersil Corporation and its products, see www.intersil.com