

ISL6420BEVAL1Z

ISL6420B Evaluation Board

AN1504

Rev 0.00

November 23, 2009

Hardware Description

The ISL6420B evaluation boards illustrates the operation of the IC.

The ISL6420B simplifies the implementation of a complete control and protection scheme for a high performance DC/DC buck converter. The IC can be operated with an input voltage range from 4.5V to 5.5V or 5.5V to 28V. It is designed to drive N-channel MOSFETs in a synchronous rectified buck topology. The control, output adjustment, monitoring and protection functions are all located in a single package.

ISL6420B Reference Design

Two versions of the evaluation board, based on the package type, are listed in Table 1. Both are configured for an output voltage of 3.3V and 10A maximum load.

TABLE 1.

BOARD NAME	IC	PACKAGE
ISL6420BEVAL1Z	ISL6420BIRZ	20 Ld QFN
ISL6420BEVAL2Z	ISL6420BIAZ	20 Ld QSSOP

The design criteria is listed in Table 2.

TABLE 2.

PAREMETERS	VALUES
Output voltage (V_{OUT})	3.3V
Output current (I_{OUT})	10A
Switching Frequency	300kHz

Power and Load Connections

If using an input supply ranging from 5.5V to 28V, connect the supply to VIN (P1) and GND (P2) posts as shown in Figure 1. ISL6420B has an internal +5V linear regulator, which can be used to bias the IC.

When using a 5V \pm 10% input supply, connect the negative polarity to GND (P2) post and connect the positive polarity of the power supply to both VIN (P1) post and the VCC5 (TP7) post. This will bypass the internal LDO and the chip will be powered by the input power supply.

CAUTION: Ensure that the voltage at VCC5 terminal does not exceed >6V. This can damage the IC.

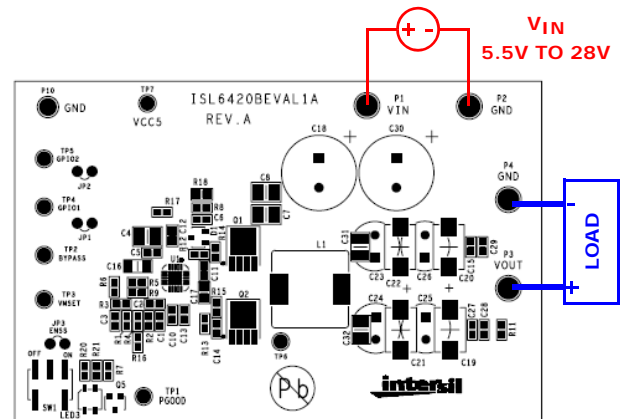

FIGURE 1. POWER AND LOAD CONNECTIONS FOR 5.5V TO 28V INPUT VOLTAGE

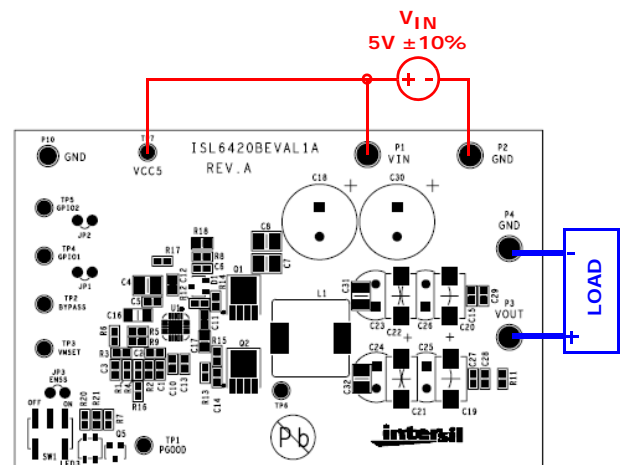

FIGURE 2. POWER AND LOAD CONNECTIONS FOR 5V \pm 10% INPUT VOLTAGE

Start-up

The Power On Reset (POR) function initiates the soft-start sequence. An internal 10 μ A current source charges an external capacitor connected to the ENSS pin from 0V to 3.3V. When the ENSS pin reaches 1V, the IC is enabled; the error amplifier reference voltage ramps from 0V to 0.6V following the slope of the ENSS pin voltage.

There are two distinct start-up methods for the ISL6420B. The first method is invoked through the application of power to the IC. The soft-start feature allows for a controlled turn-on of the output once the POR threshold of the input voltage has been reached.

Figure 3 shows the start-up profile of the regulator in relation to the start-up of the input supply.

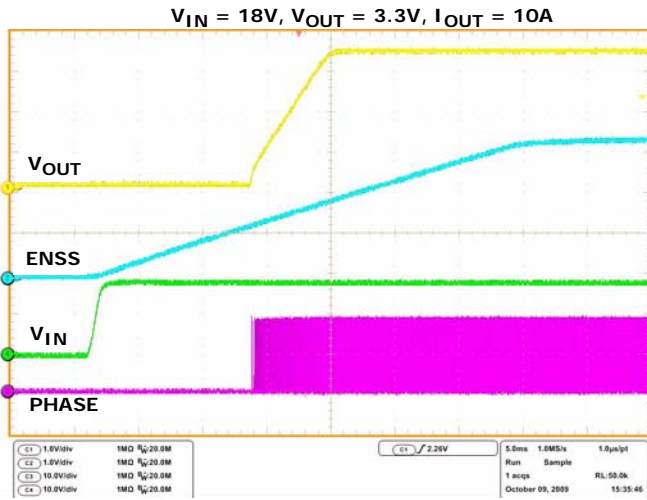

FIGURE 3. POWER-UP OF V_{IN}

The second method of start-up is through the use of the enable feature. Holding the ENSS pin on the ISL6420B below 1V will disable the regulator by forcing both the upper and lower MOSFETs off. Releasing the pin allows the regulator to start-up.

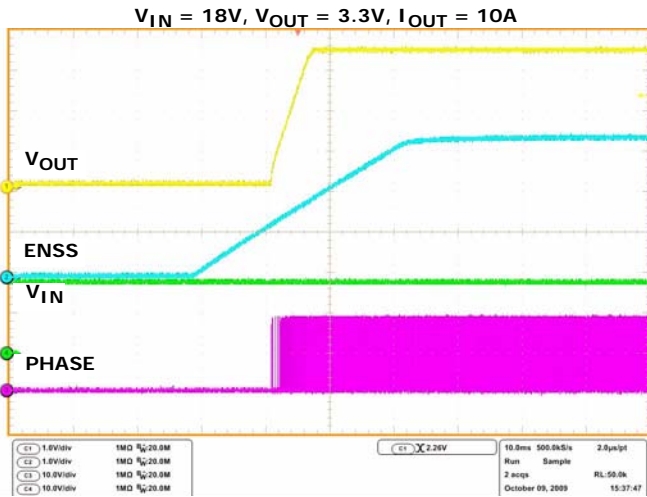

FIGURE 4. ENABLE USING ENSS

Shutdown

If the ENSS pin is pulled down and held below 1V, the regulator will be turned off. Figure 5 shows the shutdown profile of the regulator with the ENSS pin pulled low. Figure 6 shows the shutdown of the regulator when powering down the input supply.

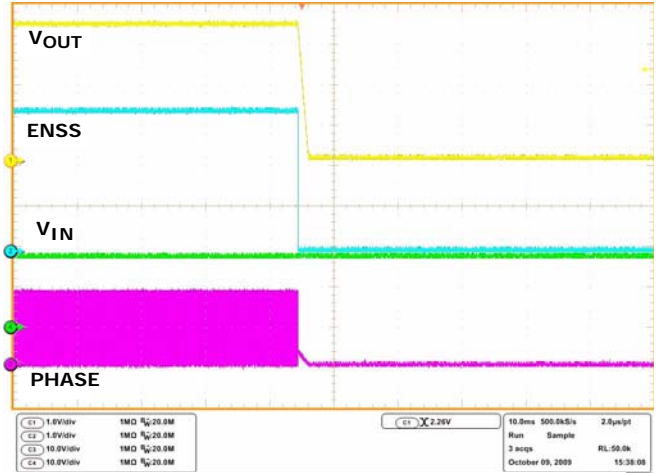

FIGURE 5. SHUTDOWN USING ENSS

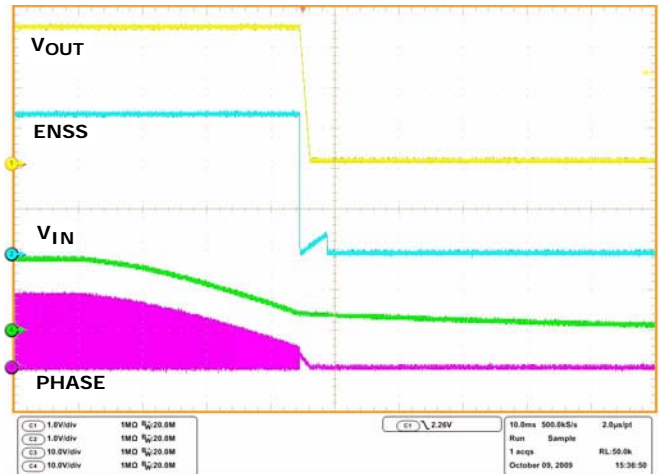

FIGURE 6. POWER-DOWN OF V_{IN}

Output Performance

Switching Frequency

The evaluation board has a 0Ω resistor R9 connecting RT to VCC5 setting the free-running switching frequency to 300kHz. The frequency can be programmed to a different value by removing R9 and populating the R5 location with a resistor value based on the desired frequency.

Output Ripple

Figure 7 shows the ripple voltage on the output of the regulator at the free running 300kHz frequency.

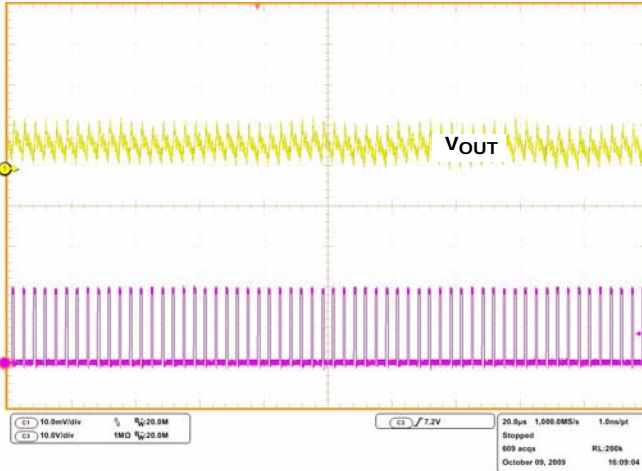

FIGURE 7. OUTPUT RIPPLE

Efficiency

ISL6420B-based regulators enable the design of highly efficient systems. The efficiency of the evaluation board using a 12V, 18V and 24V input supply, as shown in Figure 8.

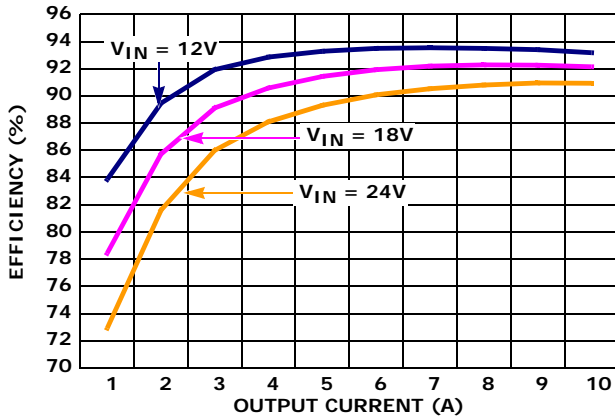

FIGURE 8. EVALUATION BOARD EFFICIENCY ($V_{OUT} = 3.3V$)

The load regulation of the evaluation board using a 12V, 18V and 24V input supply is shown in Figure 9.

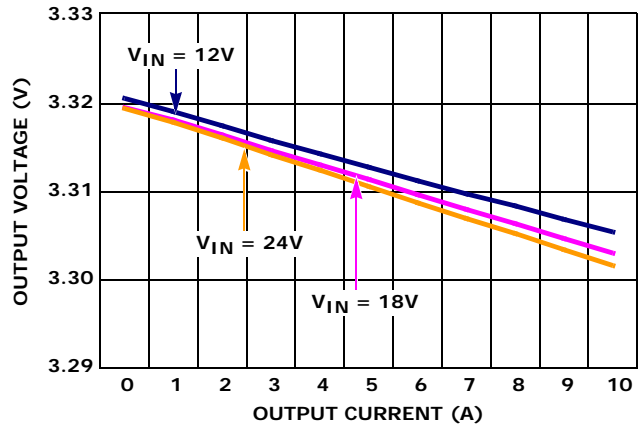

FIGURE 9. EVALUATION BOARD LOAD REGULATION ($V_{OUT} = 3.3V$)

Power Good

PGOOD will be true (open drain) when the FB pin voltage is within $\pm 10\%$ of the reference voltage and the soft-start sequence is complete, i.e., once the soft-start capacitor is finished charging. The assertion of PGOOD signal can be delayed by a time proportional to a CDEL current of $2\mu A$ and the value of the capacitor connected between this pin and ground. The status of PGOOD can be monitored at the PGOOD test point (TP1).

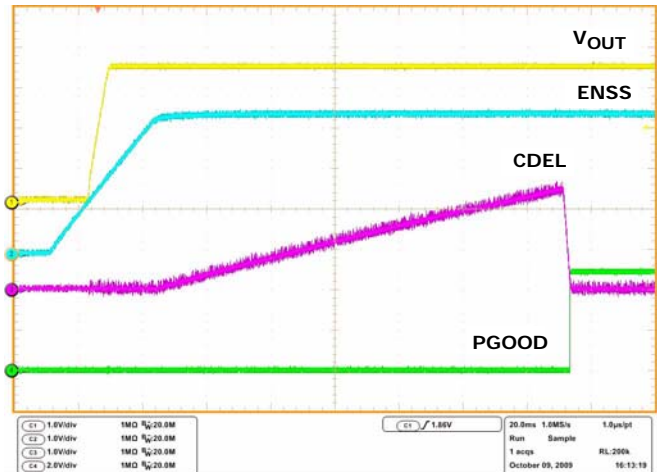

FIGURE 10. PGOOD

Overcurrent Protection

The overcurrent function cycles the soft-start function in a hiccup mode to provide fault protection. Figure 11 shows the overcurrent hiccup mode.

The overcurrent function protects the converter from a shorted output by using the upper MOSFET's $r_{DS(ON)}$ to monitor the current. This method enhances the converter's efficiency and reduces cost by eliminating a current sensing resistor.

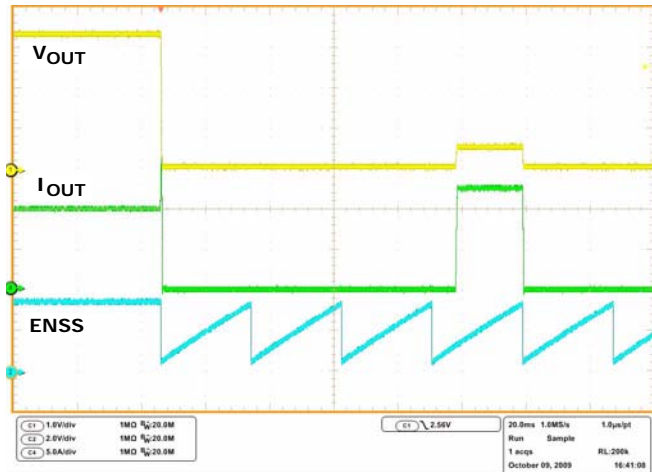

FIGURE 11. OVERCURRENT HICCUP MODE

A resistor, R_{OCSET} (R8), programs the overcurrent trip level. The PHASE node voltage is compared to the voltage on the OCSET pin while the upper FET is on. A current (100µA typically) is pulled from the OCSET pin to establish this voltage across an external resistor. If PHASE is lower than OCSET, while the upper FET is on, then an overcurrent condition is detected for that clock cycle. The pulse is immediately terminated, and a counter is incremented. If an overcurrent condition is detected for 8 consecutive clock cycles, and the circuit is not in soft-start, the ISL6420B enters into hiccup mode. During hiccup, the external capacitor on the ENSS pin is discharged and soft-start is initiated. During soft-start, pulse termination limiting is enabled, but the 8-cycle hiccup counter is held in reset until soft-start is completed.

The overcurrent function will trip at a peak inductor current (I_{PEAK}) determined by Equation 1:

$$I_{PEAK} = \frac{I_{OCSET} \cdot R_{OCSET}}{r_{DS(ON)}} \quad (EQ. 1)$$

where I_{OCSET} is the internal OCSET current source.

The OC trip point varies mainly due to the MOSFET's $r_{DS(ON)}$ variations. To avoid overcurrent tripping in the normal operating load range, calculate the R_{OCSET} resistor from Equation 1 using:

1. The maximum $r_{DS(ON)}$ at the highest junction temperature
2. The minimum I_{OCSET} from the data sheet specification table

Determine ,

$$I_{PEAK} \text{ for } I_{PEAK} > I_{OUT(MAX)} + (\Delta I)/2 \quad (EQ. 2)$$

where ΔI is the output inductor ripple current. A small ceramic capacitor should be placed in parallel with R_{OCSET} to smooth the voltage across R_{OCSET} in the presence of switching noise on the input voltage.

The overcurrent trip point on the evaluation board has been set to 16A.

Transient Performance

Figure 12, 13, and 14 show the response of the output when subjected to transient loading from 0A to 10A at 1A/µs slew rate.

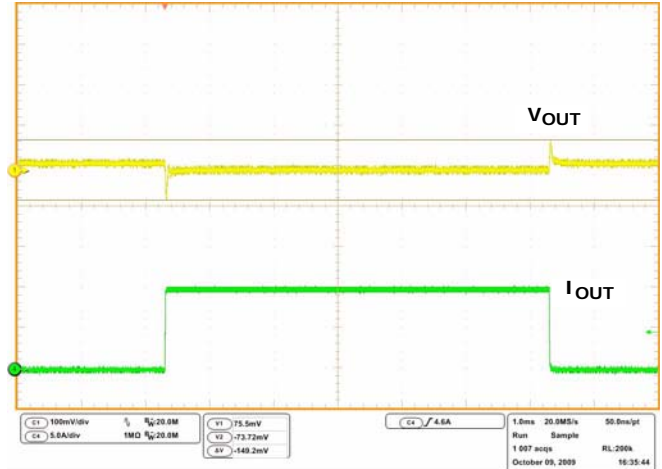

FIGURE 12. TRANSIENT RESPONSE

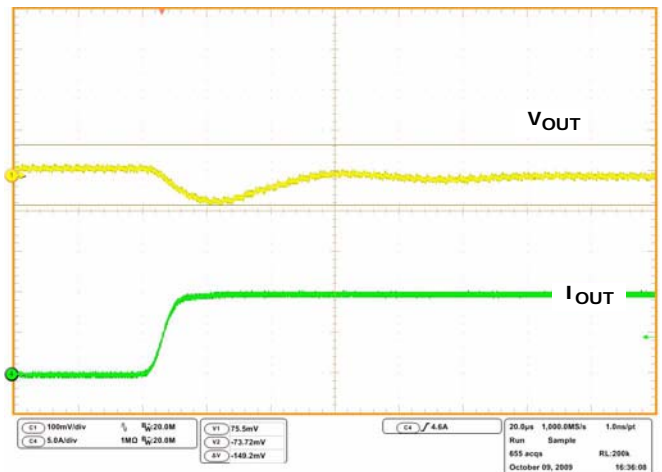

FIGURE 13. TRANSIENT RESPONSE

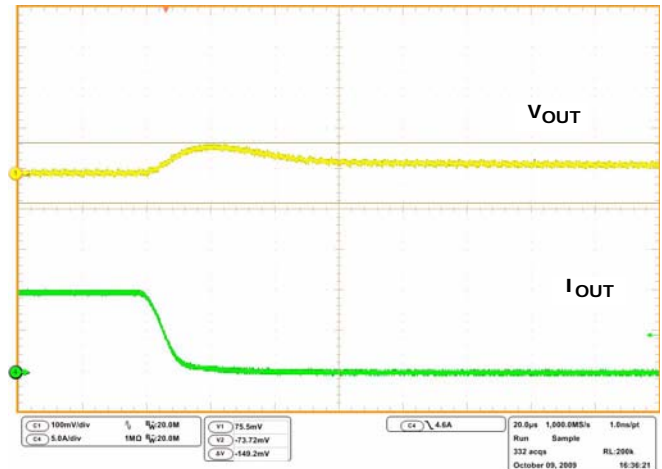

FIGURE 14. TRANSIENT RESPONSE

Voltage Margining

Voltage margining mode is enabled by connecting a margining set resistor (R6) from the VMSET pin to ground. This resistor to ground will set a current, which is switched to the FB pin. The current will be equal to 2.468V divided by the value of the external resistor tied to the VMSET pin. The range of the VMSET resistor is 150kΩ to 400kΩ.

The GPIO1 (TP4) and GPIO2 (TP5) pins control the current switching as per Table 3. The power supply output increases when GPIO2 is HIGH and decreases when GPIO1 is HIGH. Using a jumper to short the pins of JP1 and JP2 will pull GPIO1 and GPIO2 LOW, respectively. Remove one of the jumpers to pull GPIO1 or GPIO2 HIGH for voltage margining. The amount that the output voltage of the power supply changes with voltage margining will be equal to 2.468V times the ratio of the external feedback resistor (R1) and the external resistor tied to VMSET (R6).

TABLE 3.

GPIO1	GPIO2	V _{OUT}
L	L	No Change
L	H	+Δ V _{OUT}
H	L	-Δ V _{OUT}
H	H	Ignored

The evaluation board has a 330kΩ VMSET resistor (R6) setting a current:

$$I_{VM} = 2.468V / 330k\Omega = 7.48\mu A \quad (EQ. 3)$$

and:

$$V(\Delta) = 7.48\mu A \cdot 11.5k\Omega = 0.086V \quad (EQ. 4)$$

The slew time of the current is set by an external capacitor (C13) on the CDEL pin, which is charged and discharged with a 100μA current source. The change in voltage on the capacitor is 2.5V. This same capacitor is also used to set the PGOOD rise delay. When PGOOD is low, the internal PGOOD circuitry uses the capacitor and when PGOOD is high the voltage margining circuit uses the capacitor. The slew time for voltage margining can be in the range of 300μs to 2.5ms. The CDEL capacitor on the evaluation board is 0.1μF leading to a voltage margining slew rate of 2.5ms. Figures 15 and 16 show negative and positive voltage margining with a CDEL capacitor of 0.1μF.

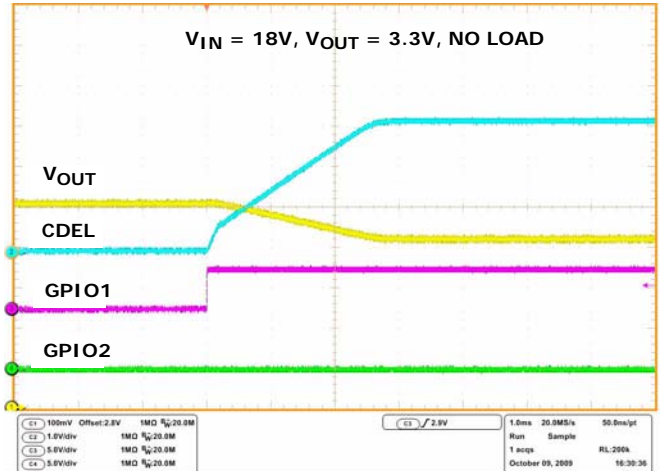

FIGURE 15. NEGATIVE VOLTAGE MARGINING SLEW TIME

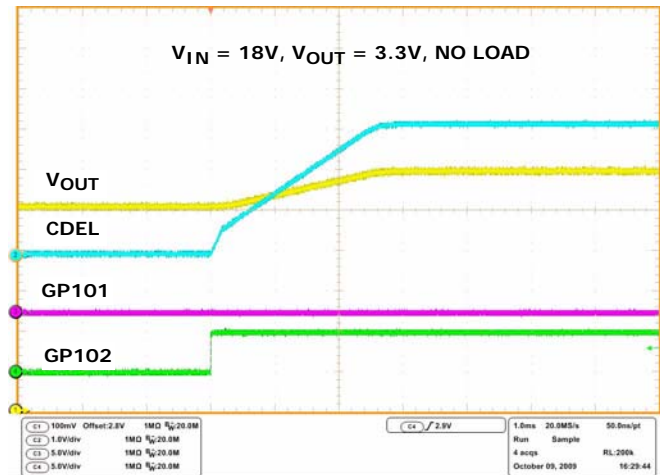

FIGURE 16. POSITIVE VOLTAGE MARGINING SLEW TIME

Layout Guidelines

DC to DC converter layout is extremely important to obtain the desired attenuation to the EMI frequencies. Poor layout practice can cause conducted emissions to actually couple around the filter components directly into the input conductors or cause radiated emissions. The copper traces of power input and output and high current paths must be sized according to the RMS current passing through them. Keep the high current loops small and the path defined. Use single point grounding. Capacitor lead length must be minimized as much as possible to reduce ESL. This includes the traces on the PC board leading up to the capacitor pads. Based on the layout, voltage transients may reduce the level of the acceptable max V_{IN} when operating close to 28V. In this case, one can consider the use of snubbers or reduce the max V_{IN} . Use of a GND plane in a multilayered board is preferred.

References

For Intersil documents available on the web, see <http://www.intersil.com/>

- [1] [ISL6420A Data Sheet, Advanced Single Synchronous Buck Pulse-Width Modulation \(PWM\) Controller, Intersil Corporation, File No. FN9169.](#)
- [2] [ISL6420B Data Sheet, Advanced Single Synchronous Buck Pulse-Width Modulation \(PWM\) Controller, File No. FN6901.](#)

ISL6420BEVAL1Z Schematic

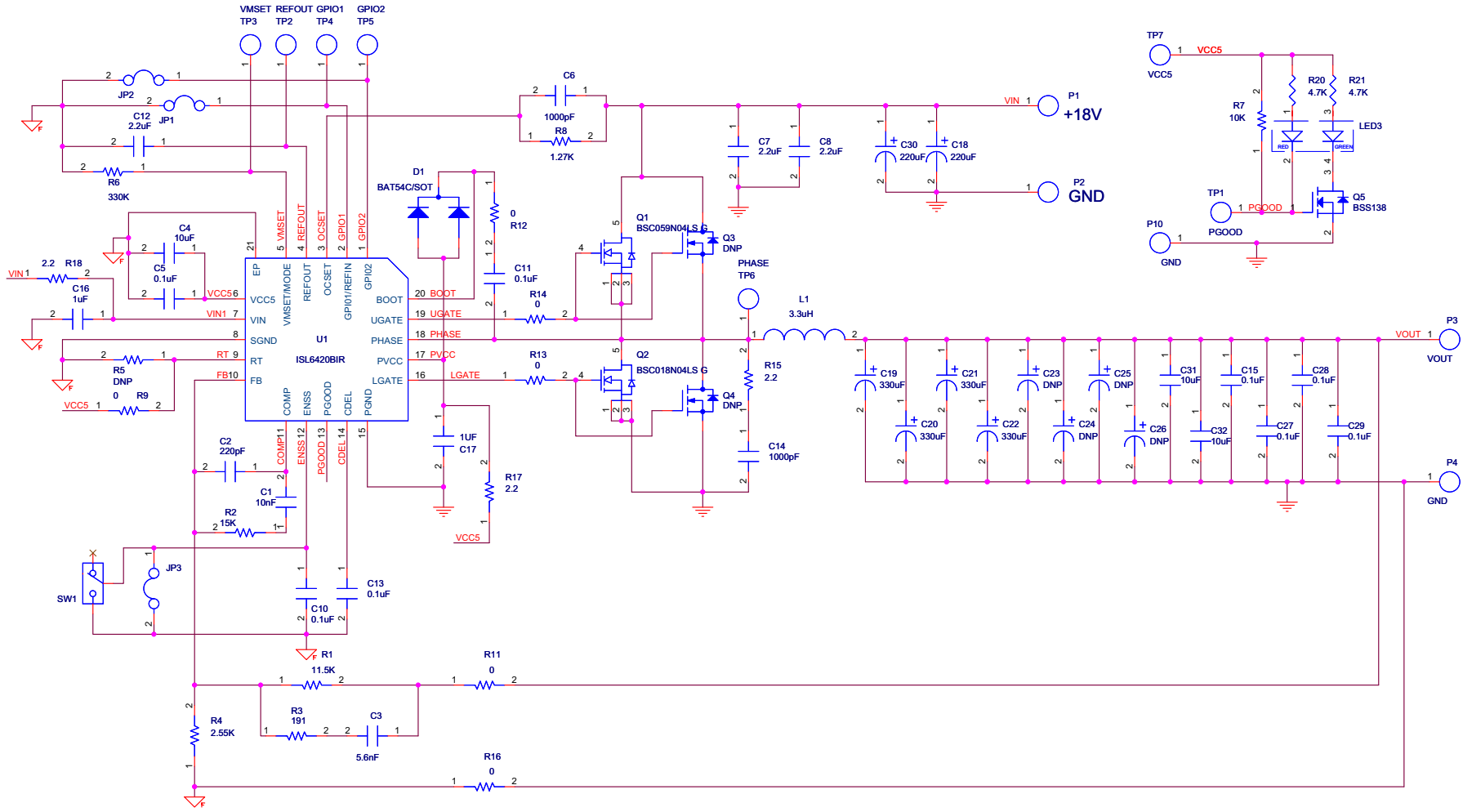

ISL6420BEVAL1Z Rev. A Bill of Materials

ID	REFERENCE	QTY	PART NUMBER	PART TYPE	DESCRIPTION	PACKAGE	VENDOR
1	U1	1	ISL6420BIRZ	PWM Controller IC	IC, Single PWM Controller	20 Ld 4x4 QFN	Intersil
2	Q1	1	BSC059N04LS G	MOSFET, Single	N-channel, 40V	SuperSO8	Infineon
3	Q2	1	BSC018N04LS G	MOSFET, Single	N-channel, 40V	SuperSO8	Infineon
4	Q3, Q4		Do not populate				
5	Q5	1	BSS138LT1G	MOSFET, Single	N-channel, 50V, 200mA	SOT23	On Semi
6	D1	1	BAT54C	Diode, Schottky	30V, 200mA	SOT23	Fairchild
7	L1	1	HC9-3R3-R	Inductor	3.3 μ H, 20%, 14.3A	SMD	Coiltronics
CAPACITORS							
8	C1	1		Capacitor, Ceramic, X7R	0.01 μ F, 10%, 50V	SM_0603	Various
9	C2	1		Capacitor, Ceramic, COG	220pF, 10%, 50V	SM_0603	Various
10	C3	1		Capacitor, Ceramic, X7R	5600pF, 10%, 50V	SM_0603	Various
11	C4, C31, C32	3		Capacitor, Ceramic, X7R	1 μ F, 10%, 25V	SM_1210	Various
12	C5, C10, C11, C13, C15, C27, C28, C29	8		Capacitor, Ceramic, X7R	0.1 μ F, 10%, 50V	SM_0603	Various
13	C6, C14	2		Capacitor, Ceramic, X7R	1000pF, 10%, 50V	SM_0603	Various
14	C7, C8	2		Capacitor, Ceramic, X7R	2.2 μ F, 10%, 50V	SM_1210	Various
15	C12	1		Capacitor, Ceramic, X5R	2.2 μ F, 10%, 16V	SM_1206	Various
16	C16	1		Capacitor, Ceramic, X7R	1 μ F, 10%, 50V	SM_1206	Various
17	C17	1		Capacitor, Ceramic, X7R	1 μ F, 10%, 50V	SM_0805	Various
18	C18, C30	2	EEUFC1H221S	Capacitor, Alum. Elec.	220 μ F, 20%, 50V, 1150mA	12.5 X 15	Panasonic
19	C19, C20, C21, C22	4	6TPB330M9L	Capacitor, POSCAP	330 μ F, 20%, 6.3V, 0.009 Ω	Case D3L	SANYO
20	C23, C24, C25, C26		Do not populate				
RESISTORS							
21	R1	1		Resistor, Film	11.5k Ω , 1%, 1/10W	SM_0603	Various
22	R2	1		Resistor, Film	15k Ω , 1%, 1/10W	SM_0603	Various
23	R3	1		Resistor, Film	191 Ω , 1%, 1/10W	SM_0603	Various
24	R4	1		Resistor, Film	2.55k Ω , 1%, 1/10W	SM_0603	Various
25	R6	1		Resistor, Film	330k Ω , 1%, 1/10W	SM_0603	Various
26	R7	1		Resistor, Film	10k Ω , 1%, 1/10W	SM_0603	Various
27	R8	1		Resistor, Film	1.27k Ω , 1%, 1/10W	SM_0603	Various

ISL6420BEVAL1Z Rev. A Bill of Materials (Continued)

ID	REFERENCE	QTY	PART NUMBER	PART TYPE	DESCRIPTION	PACKAGE	VENDOR
28	R9, R11, R12, R13, R14, R16	6		Resistor, Film	0Ω, 1/10W	SM_0603	Various
29	R15, R17, R18	3		Resistor, Film	2.2Ω, 1%, 1/10W	SM_0603	Various
30	R20, R21	2		Resistor, Film	4.7kΩ, 1%, 1/10W	SM_0603	Various
31	R5		Do not populate				
OTHERS							
32	P1 - P4	4	1514-2	Turret Post	Terminal post, through hole, 1/4 inch	PTH	Keystone
33	TP1 - TP5	3	5002	TEST POINT vertical, white	PC test jack	PTH	Keystone
34	JP1, JP2, JP3	3	69190-202HLF	Header	1X2 Break Strip GOLD		BERG/FCI
35	JP1, JP2	2	SPC02SYAN	Jumper	Connector Jumper		Sullins
36	LED3	1	SSL-LXA3025IGC	LED	LED, Red/Green	SMD3x2.5 mm	Lumex
37	SW1	1	GT11MSCBE-T	Toggle Switch	SPDT Toggle Switch	SMD	ITT
38	P10		Do not populate				
39	TP6		Do not populate				

ISL6420BEVAL1Z Printed Circuit Board Layers

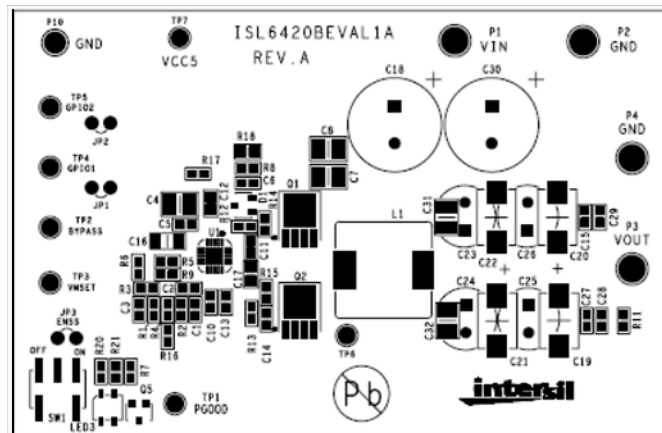

FIGURE 17. ISL6420BEVAL1Z - TOP LAYER (SILKSCREEN)

ISL6420BEVAL1Z Printed Circuit Board Layers (Continued)

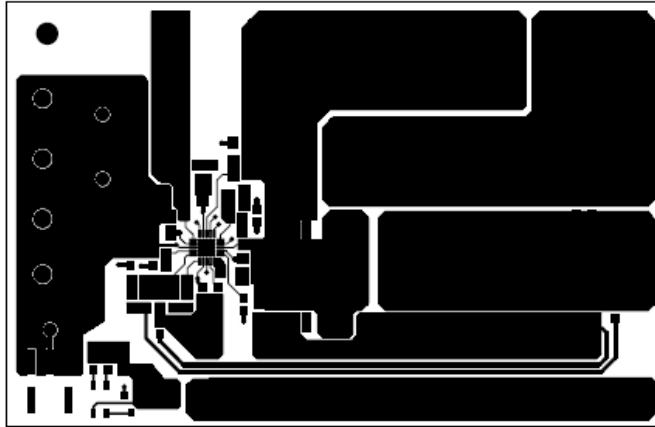

FIGURE 18. ISL6420BEVAL1Z - TOP LAYER (COMPONENT SIDE)

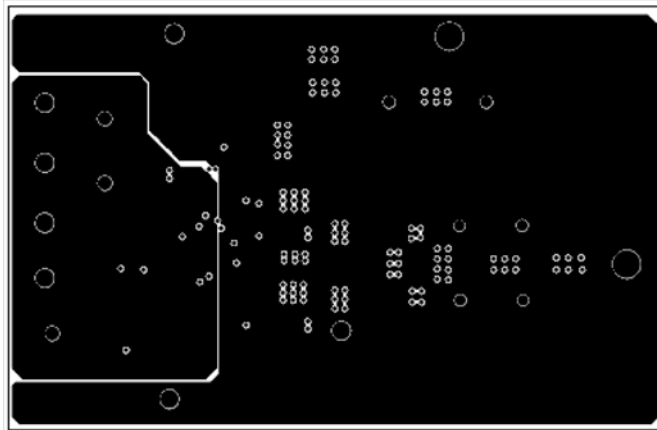

FIGURE 19. ISL6420BEVAL1Z - LAYER 2

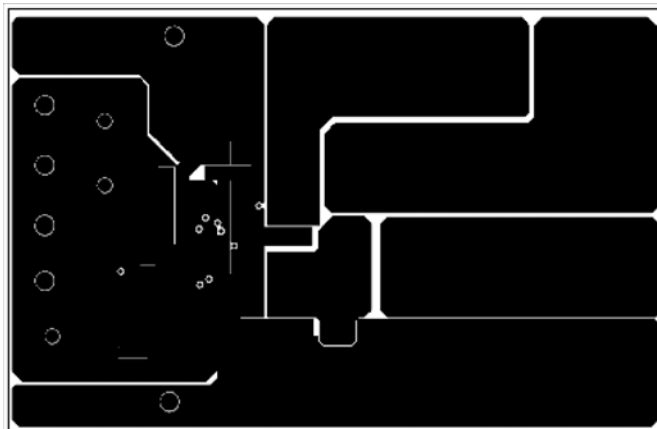

FIGURE 20. ISL6420BEVAL1Z - LAYER 3

ISL6420BEVAL1Z Printed Circuit Board Layers (Continued)

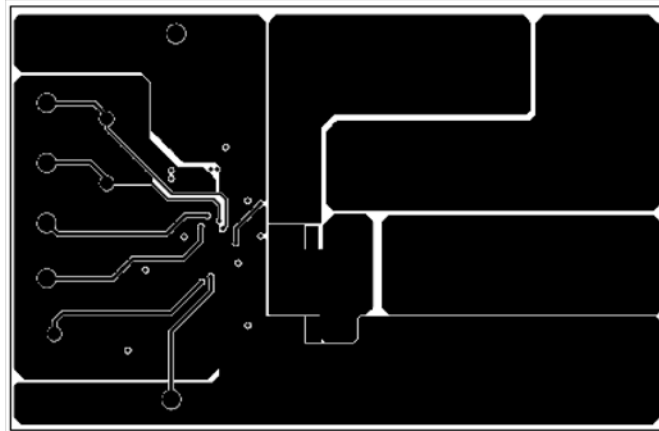

FIGURE 21. ISL6420BEVAL1Z - BOTTOM LAYER (SOLDER SIDE)

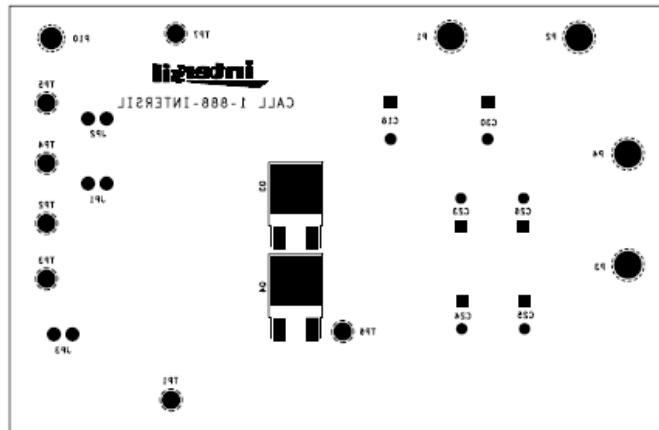
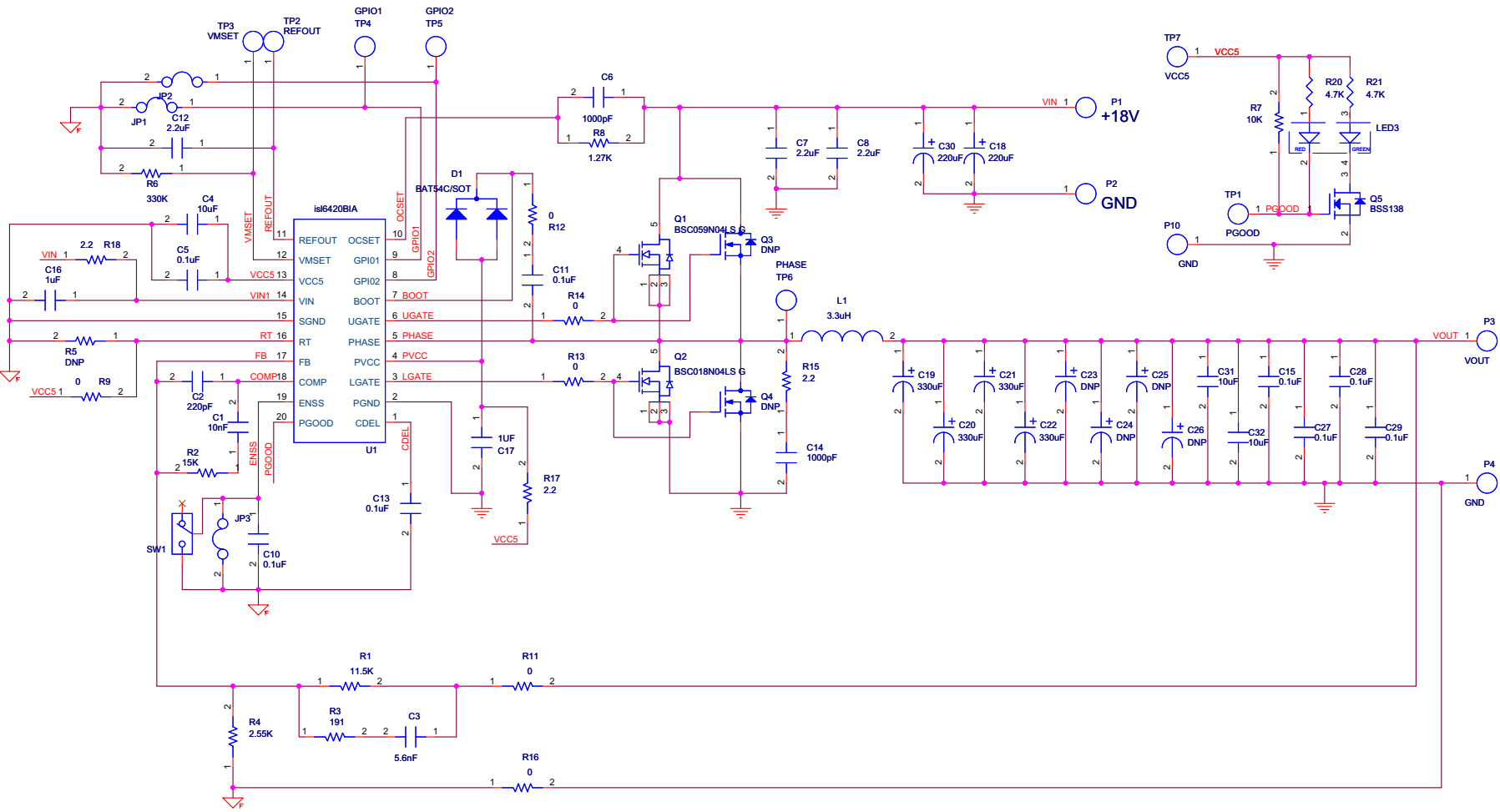

FIGURE 22. ISL6420BEVAL1Z - BOTTOM LAYER (SILKSCREEN)

ISL6420BEVAL2Z Schematic



ISL6420BEVAL2Z Rev. A Bill of Materials

ID	REFERENCE	QTY	PART NUMBER	PART TYPE	DESCRIPTION	PACKAGE	VENDOR
1	U1	1	ISL6420BIAZ	PWM Controller IC	IC, Single PWM Controller	20 Ld QSOP	Intersil
2	Q1	1	BSC059N04LS G	MOSFET, Single	N-channel, 40V	SuperSO8	Infineon
3	Q2	1	BSC018N04LS G	MOSFET, Single	N-channel, 40V	SuperSO8	Infineon
4	Q3, Q4		Do not populate				
5	Q5	1	BSS138LT1G	MOSFET, Single	N-channel, 50V, 200mA	SOT23	On Semi
6	D1	1	BAT54C	Diode, Schottky	30V, 200mA	SOT23	Fairchild
7	L1	1	HC9-3R3-R	Inductor	3.3 μ H, 20%, 14.3A	SMD	Coiltronics
CAPACITORS							
8	C1	1		Capacitor, Ceramic, X7R	0.01 μ F, 10%, 50V	SM_0603	Various
9	C2	1		Capacitor, Ceramic, COG	220pF, 10%, 50V	SM_0603	Various
10	C3	1		Capacitor, Ceramic, X7R	5600pF, 10%, 50V	SM_0603	Various
11	C4, C31, C32	3		Capacitor, Ceramic, X7R	1 μ F, 10%, 25V	SM_1210	Various
12	C5, C10, C11, C13, C15, C27, C28, C29	8		Capacitor, Ceramic, X7R	0.1 μ F, 10%, 50V	SM_0603	Various
13	C6, C14	2		Capacitor, Ceramic, X7R	1000pF, 10%, 50V	SM_0603	Various
14	C7, C8	2		Capacitor, Ceramic, X7R	2.2 μ F, 10%, 50V	SM_1210	Various
15	C12	1		Capacitor, Ceramic, X5R	2.2 μ F, 10%, 16V	SM_1206	Various
16	C16	1		Capacitor, Ceramic, X7R	1 μ F, 10%, 50V	SM_1206	Various
17	C17	1		Capacitor, Ceramic, X7R	1 μ F, 10%, 50V	SM_0805	Various
18	C18, C30	2	EEUFC1H221S	Capacitor, Alum. Elec.	220 μ F, 20%, 50V, 1150mA	12.5 X 15	Panasonic
19	C19, C20, C21, C22	4	6TPB330M9L	Capacitor, POSCAP	330 μ F, 20%, 6.3V, 0.009 Ω	Case D3L	SANYO
20	C23, C24, C25, C26		Do not populate				
RESISTORS							
21	R1	1		Resistor, Film	11.5k Ω , 1%, 1/10W	SM_0603	Various
22	R2	1		Resistor, Film	15k Ω , 1%, 1/10W	SM_0603	Various
23	R3	1		Resistor, Film	191 Ω , 1%, 1/10W	SM_0603	Various
24	R4	1		Resistor, Film	2.55k Ω , 1%, 1/10W	SM_0603	Various
25	R6	1		Resistor, Film	330k Ω , 1%, 1/10W	SM_0603	Various
26	R7	1		Resistor, Film	10k Ω , 1%, 1/10W	SM_0603	Various
27	R8	1		Resistor, Film	1.27k Ω , 1%, 1/10W	SM_0603	Various

ISL6420BEVAL2Z Rev. A Bill of Materials (Continued)

ID	REFERENCE	QTY	PART NUMBER	PART TYPE	DESCRIPTION	PACKAGE	VENDOR
28	R9, R11, R12, R13, R14, R16	6		Resistor, Film	0Ω, 1/10W	SM_0603	Various
29	R15, R17, R18	3		Resistor, Film	2.2Ω, 1%, 1/10W	SM_0603	Various
30	R20, R21	2		Resistor, Film	4.7kΩ, 1%, 1/10W	SM_0603	Various
31	R5		Do not populate				
OTHERS							
32	P1 - P4	4	1514-2	Turrett Post	Terminal post, through hole, 1/4 inch	PTH	Keystone
33	TP1 - TP5	3	5002	TEST POINT vertical, white	PC test jack	PTH	Keystone
34	JP1, JP2, JP3	3	69190-202HLF	Header	1X2 Break Strip GOLD		BERG/FCI
35	JP1, JP2	2	SPC02SYAN	Jumper	Connector Jumper		Sullins
36	LED3	1	SSL-LXA30251GC	LED	LED, Red/Green	SMD3x2.5 mm	Lumex
37	SW1	1	GT11MSCBE-T	Toggle Switch	SPDT Toggle Switch	SMD	ITT
38	P10		Do not populate				
39	TP6		Do not populate				

ISL6420BEVAL2Z Printed Circuit Board Layers

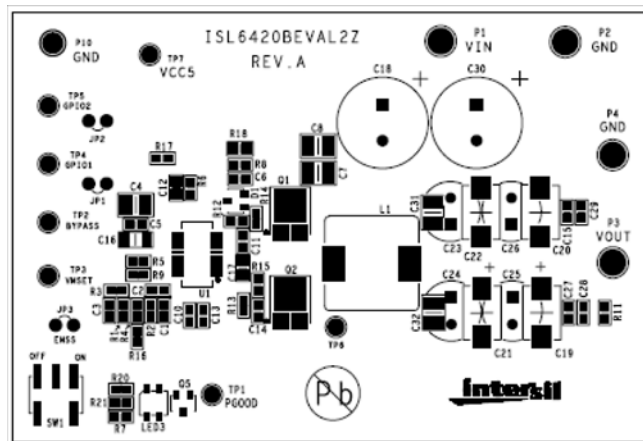

FIGURE 23. ISL6420BEVAL2Z - TOP LAYER (SILKSCREEN)

ISL6420BEVAL2Z Printed Circuit Board Layers (Continued)

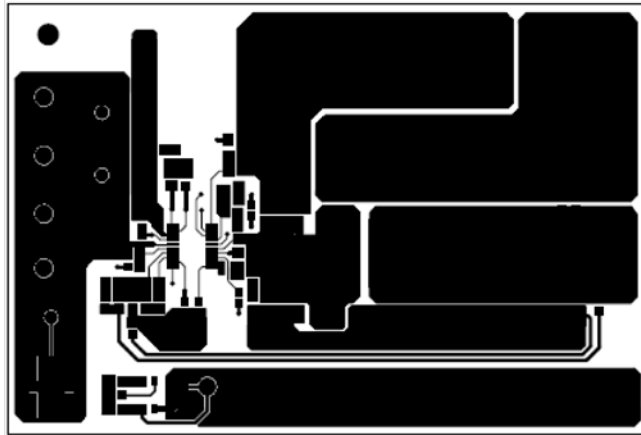

FIGURE 24. ISL6420BEVAL2Z - TOP LAYER (COMPONENT SIDE)

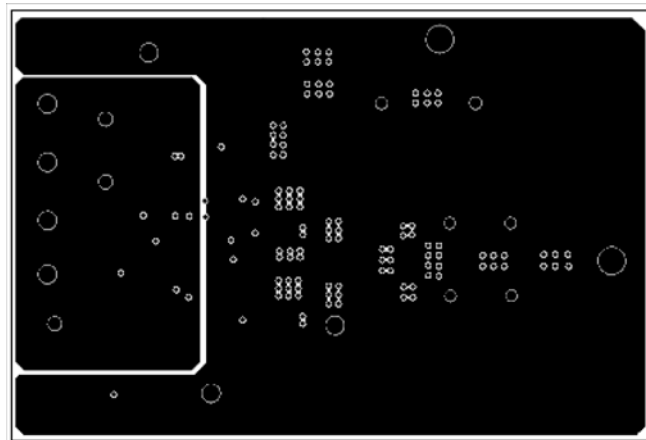

FIGURE 25. ISL6420BEVAL2Z - LAYER 2

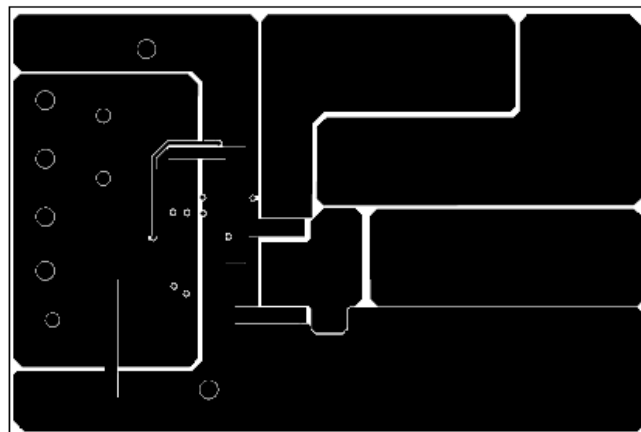

FIGURE 26. ISL6420BEVAL2Z - LAYER 3

ISL6420BEVAL2Z Printed Circuit Board Layers (Continued)

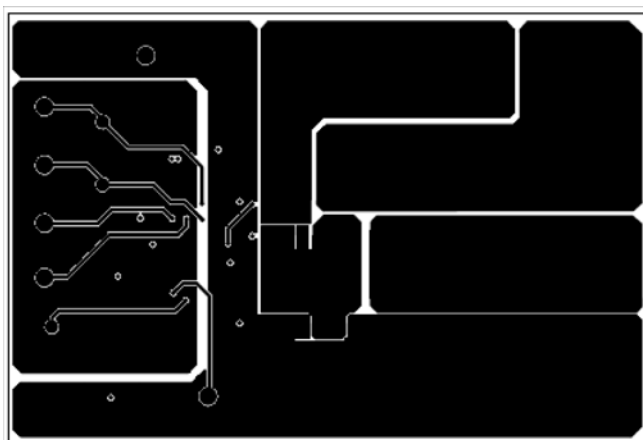

FIGURE 27. ISL6420BEVAL2Z - BOTTOM LAYER (SOLDER SIDE)

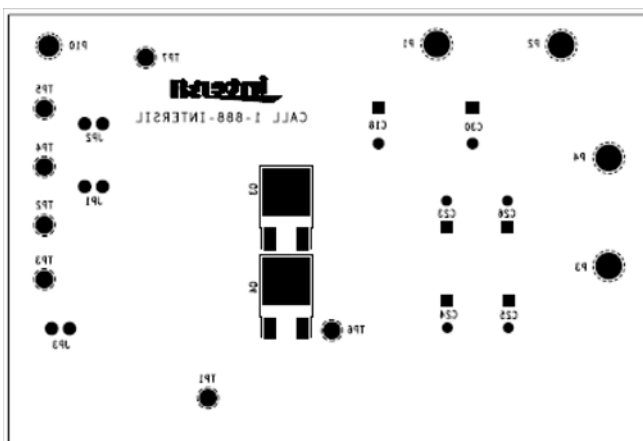

FIGURE 28. ISL6420AEVAL2Z - BOTTOM LAYER (SILKSCREEN)

Notice

1. Descriptions of circuits, software and other related information in this document are provided only to illustrate the operation of semiconductor products and application examples. You are fully responsible for the incorporation or any other use of the circuits, software, and information in the design of your product or system. Renesas Electronics disclaims any and all liability for any losses and damages incurred by you or third parties arising from the use of these circuits, software, or information.
2. Renesas Electronics hereby expressly disclaims any warranties against and liability for infringement or any other claims involving patents, copyrights, or other intellectual property rights of third parties, by or arising from the use of Renesas Electronics products or technical information described in this document, including but not limited to, the product data, drawings, charts, programs, algorithms, and application examples.
3. No license, express, implied or otherwise, is granted hereby under any patents, copyrights or other intellectual property rights of Renesas Electronics or others.
4. You shall not alter, modify, copy, or reverse engineer any Renesas Electronics product, whether in whole or in part. Renesas Electronics disclaims any and all liability for any losses or damages incurred by you or third parties arising from such alteration, modification, copying or reverse engineering.
5. Renesas Electronics products are classified according to the following two quality grades: "Standard" and "High Quality". The intended applications for each Renesas Electronics product depends on the product's quality grade, as indicated below.
"Standard": Computers; office equipment; communications equipment; test and measurement equipment; audio and visual equipment; home electronic appliances; machine tools; personal electronic equipment; industrial robots; etc.
"High Quality": Transportation equipment (automobiles, trains, ships, etc.); traffic control (traffic lights); large-scale communication equipment; key financial terminal systems; safety control equipment; etc.
Unless expressly designated as a high reliability product or a product for harsh environments in a Renesas Electronics data sheet or other Renesas Electronics document, Renesas Electronics products are not intended or authorized for use in products or systems that may pose a direct threat to human life or bodily injury (artificial life support devices or systems; surgical implantations; etc.), or may cause serious property damage (space system; undersea repeaters; nuclear power control systems; aircraft control systems; key plant systems; military equipment; etc.). Renesas Electronics disclaims any and all liability for any damages or losses incurred by you or any third parties arising from the use of any Renesas Electronics product that is inconsistent with any Renesas Electronics data sheet, user's manual or other Renesas Electronics document.
6. When using Renesas Electronics products, refer to the latest product information (data sheets, user's manuals, application notes, "General Notes for Handling and Using Semiconductor Devices" in the reliability handbook, etc.), and ensure that usage conditions are within the ranges specified by Renesas Electronics with respect to maximum ratings, operating power supply voltage range, heat dissipation characteristics, installation, etc. Renesas Electronics disclaims any and all liability for any malfunctions, failure or accident arising out of the use of Renesas Electronics products outside of such specified ranges.
7. Although Renesas Electronics endeavors to improve the quality and reliability of Renesas Electronics products, semiconductor products have specific characteristics, such as the occurrence of failure at a certain rate and malfunctions under certain use conditions. Unless designated as a high reliability product or a product for harsh environments in a Renesas Electronics data sheet or other Renesas Electronics document, Renesas Electronics products are not subject to radiation resistance design. You are responsible for implementing safety measures to guard against the possibility of bodily injury, injury or damage caused by fire, and/or danger to the public in the event of a failure or malfunction of Renesas Electronics products, such as safety design for hardware and software, including but not limited to redundancy, fire control and malfunction prevention, appropriate treatment for aging degradation or any other appropriate measures. Because the evaluation of microcomputer software alone is very difficult and impractical, you are responsible for evaluating the safety of the final products or systems manufactured by you.
8. Please contact a Renesas Electronics sales office for details as to environmental matters such as the environmental compatibility of each Renesas Electronics product. You are responsible for carefully and sufficiently investigating applicable laws and regulations that regulate the inclusion or use of controlled substances, including without limitation, the EU RoHS Directive, and using Renesas Electronics products in compliance with all these applicable laws and regulations. Renesas Electronics disclaims any and all liability for damages or losses occurring as a result of your noncompliance with applicable laws and regulations.
9. Renesas Electronics products and technologies shall not be used for or incorporated into any products or systems whose manufacture, use, or sale is prohibited under any applicable domestic or foreign laws or regulations. You shall comply with any applicable export control laws and regulations promulgated and administered by the governments of any countries asserting jurisdiction over the parties or transactions.
10. It is the responsibility of the buyer or distributor of Renesas Electronics products, or any other party who distributes, disposes of, or otherwise sells or transfers the product to a third party, to notify such third party in advance of the contents and conditions set forth in this document.
11. This document shall not be reprinted, reproduced or duplicated in any form, in whole or in part, without prior written consent of Renesas Electronics.
12. Please contact a Renesas Electronics sales office if you have any questions regarding the information contained in this document or Renesas Electronics products.
(Note 1) "Renesas Electronics" as used in this document means Renesas Electronics Corporation and also includes its directly or indirectly controlled subsidiaries.
(Note 2) "Renesas Electronics product(s)" means any product developed or manufactured by or for Renesas Electronics.

(Rev.4.0-1 November 2017)



SALES OFFICES

Renesas Electronics Corporation

<http://www.renesas.com>

Refer to "<http://www.renesas.com/>" for the latest and detailed information.

Renesas Electronics America Inc.
1001 Murphy Ranch Road, Milpitas, CA 95035, U.S.A.
Tel: +1-408-432-8888, Fax: +1-408-434-5351

Renesas Electronics Canada Limited
9251 Yonge Street, Suite 8309 Richmond Hill, Ontario Canada L4C 9T3
Tel: +1-905-237-2004

Renesas Electronics Europe Limited
Dukes Meadow, Millboard Road, Bourne End, Buckinghamshire, SL8 5FH, U.K.
Tel: +44-1628-651-700, Fax: +44-1628-651-804

Renesas Electronics Europe GmbH
Arcadiastrasse 10, 40472 Düsseldorf, Germany
Tel: +49-211-6503-0, Fax: +49-211-6503-1327

Renesas Electronics (China) Co., Ltd.
Room 1709 Quantum Plaza, No.27 ZhichunLu, Haidian District, Beijing, 100191 P. R. China
Tel: +86-10-8235-1155, Fax: +86-10-8235-7679

Renesas Electronics (Shanghai) Co., Ltd.
Unit 301, Tower A, Central Towers, 555 Langao Road, Putuo District, Shanghai, 200333 P. R. China
Tel: +86-21-2226-0888, Fax: +86-21-2226-0999

Renesas Electronics Hong Kong Limited
Unit 1601-1611, 16/F., Tower 2, Grand Century Place, 193 Prince Edward Road West, Mongkok, Kowloon, Hong Kong
Tel: +852-2265-6688, Fax: +852-2886-9022

Renesas Electronics Taiwan Co., Ltd.
13F, No. 363, Fu Shing North Road, Taipei 10543, Taiwan
Tel: +886-2-8175-9600, Fax: +886-2-8175-9670

Renesas Electronics Singapore Pte. Ltd.
80 Bendemeer Road, Unit #06-02 Hyflux Innovation Centre, Singapore 339949
Tel: +65-6213-0200, Fax: +65-6213-0300

Renesas Electronics Malaysia Sdn.Bhd.
Unit 1207, Block B, Menara Amcorp, Amcorp Trade Centre, No. 18, Jln Persiaran Barat, 46050 Petaling Jaya, Selangor Darul Ehsan, Malaysia
Tel: +60-3-7955-9390, Fax: +60-3-7955-9510

Renesas Electronics India Pvt. Ltd.
No.777C, 100 Feet Road, HAL 2nd Stage, Indiranagar, Bangalore 560 038, India
Tel: +91-80-67208700, Fax: +91-80-67208777

Renesas Electronics Korea Co., Ltd.
17F, KAMCO Yangjae Tower, 262, Gangnam-daero, Gangnam-gu, Seoul, 06265 Korea
Tel: +82-2-558-3737, Fax: +82-2-558-5338