

ISL78171EVAL1Z

Evaluation Board User Guide

UG035  
Rev 1.00  
June 15, 2015

**Description**

This quick start guide pertains to the ISL78171EVAL1Z Evaluation Board. This board is populated with 60 LEDs in 6P10S (six parallel strings, each string consisting of 10 LEDs in series) configuration to simplify evaluation and testing. The device can function with or without an I<sup>2</sup>C controller. If it is required to use I<sup>2</sup>C control for the ISL78171EVAL1Z board, use a generic I<sup>2</sup>C interface adapter (not supplied with the evaluation board kit) for the purpose of communication. Please note that the slave address on the [ISL78171](#) is hexadecimal 58. Please refer to the quick setup guides for jumper settings and power-up instructions.

**Specifications**

This board has been configured and optimized for the following operating conditions:

- Input voltage: 4.5V to 26.5V
- Output voltage: 32V typical and 40V max
- LED string current 20mA typical

**PCB Details**

Board dimension = 5.525x2.550inch

Number of layers = 2

Type = FR4

Copper thickness = 2oz

**Key Features**

- Integrated 40V boost converter
- 6 Precision current sinks, up to 50mA each
- Current matching  $\pm 0.7\%$  typical
- Dimming modes: DC, internal PWM, direct PWM, DC + Int/Dir PWM
- Typical dimming ratio exceeding 60,000:1 for DC + Int/Dir PWM
- Phase shift control for internal PWM dimming
- 600kHz/800kHz/1.2MHz I<sup>2</sup>C selectable switching frequency
- Dynamic headroom control

**References**

[ISL78171](#) Datasheet

**Ordering Information**

PART NUMBER	DESCRIPTION
ISL78171EVAL1Z	ISL78171 Evaluation Board

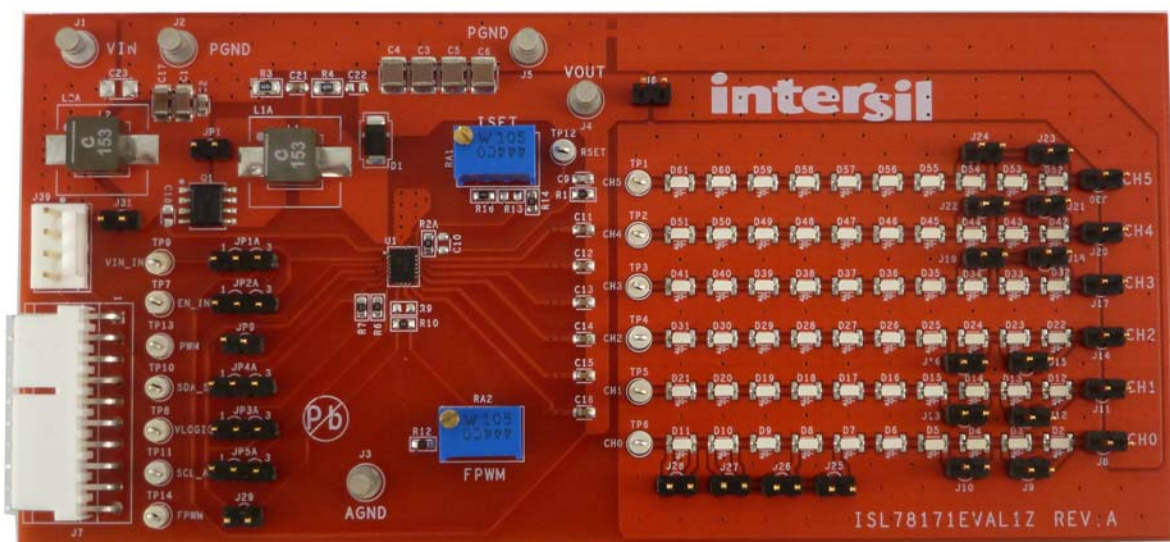

FIGURE 1. ISL78171EVAL1Z FRONT SIDE

## Recommended Equipment

The following equipment is recommended to perform testing:

- 0V to 30V power supply with 5A source current capability
- Digital Multimeters (DMMs)
- 500MHz quad-trace oscilloscope
- Signal generator for PWM pins

## Quick Setup Guide (Non I<sup>2</sup>C)

1. Ensure that the circuit is correctly connected to the supply.
2. Connect the VIN+ supply to both J1 = BOOST-VIN and TP9 = VIN\_IN.
3. OPEN: Jumpers JP1, JP9, J9, J10, J12, J13, J15, J16, J18, J19, J21, J22, J24, J25, J26, J27 and J28.
4. CLOSE: Jumpers JP1A:1-2, JP2A:2-3, JP3A:2-3, JP4A:2-3, JP5A:2-3, J6, J8, J11, J14, J17, J20, J29, J30 and J31.
5. Apply 200Hz, 0-5V, 50% duty, square wave to TP13.
6. Measure the voltage between J4 and J5. IT should read ~32V
7. Note that the 6P10S LED strings are ON.
8. Apply 5V to TP13 and trim RA1 to set the LED current in CH0 to measure 20mA using a DMM in series with J8.
9. Apply a square wave of 200Hz, 5V and vary the duty from 0% to 100% and check that the LED varies from OFF to 100% brightness.
10. Check that the current in J8 in step 9 varies from ~0mA to 20mA. Test complete turn OFF supplies.

## Quick Setup Guide (I<sup>2</sup>C)

1. Ensure that the circuit is correctly connected to the supply.
2. Connect the VIN+ supply to both J1 = BOOST-VIN and TP9 = VIN\_IN.
3. OPEN: Jumpers JP1, JP9, J9, J10, J12, J13, J15, J16, J18, J19, J21, J22, J24, J25, J26, J27, J28 and J29.
4. CLOSE: Jumper JP1A:1-2, JP2A:2-3, JP3A:2-3, JP4A:1-2, JP5A:1-2, J6, J8, J11, J14, J17, J20, J30 and J31.
5. Connect an I<sup>2</sup>C controller bus to either J7 or J39.
6. Set device address to 0x58.
7. IC enable is shorted to VIN by connecting jumper JP2A:2-3, so that the EN is driven by TP9.
8. VLOGIC level for I<sup>2</sup>C can be generated from VDC by connecting jumper JP3A:2-3. VLOGIC can be driven from TP7 (VLOGIC) by shorting jumper JP3A:1-2.
9. The configuration of VIN (JP1A), EN (JP2A) and VLOGIC (JP3A) can be quickly found by referring to the table printed on the bottom of the evaluation board, as shown in [Figure 6 on page 7](#).
10. There are 4 different operation modes for ISL78171. The setting for each mode is shown on the other table printed on the bottom of the evaluation board, as shown in [Figure 6 on page 7](#).
11. For I<sup>2</sup>C/SMBUS and DPST mode, connect the I<sup>2</sup>C interface board to the ISL78171EVAL1Z board.

12. For I<sup>2</sup>C/SMBUS and DPST mode, in order to enable the board, write a hex 58 for slave address and write a hex 05 to register 01.
13. For DPST mode I<sup>2</sup>C dimming, write hex 01 to register 01 (see data sheet for more details).
14. For DPST mode with PWM dimming, write hex 03 to register 01. This will allow PWM dimming in DPST mode.

**TABLE 1. LED STRINGS CONFIGURATIONS WITH DIFFERENT JUMPER SETTINGS**

LED CONFIGURATION	6P10S	6P9S	6P8S
J6	Short		
J8	Short		
J11			
J14			
J17			
JJ20			
J30			
J10			
J13			
J16			
J19			
J22			
J24			
J9	Open	Open	Short
J12			
J15			
J18			
J21			
J23			

15. The LED current can be programmed by varying POT RA1 using [Equation 1](#):

$$I_{LED} = 410.5 / (R_{A1} + R_{16}) = 410.5 / R_{13} \quad (\text{EQ. 1})$$

The measured current divided by six is the LED current per channel. For example, 120mA measured current will correspond to 20mA/channel.

16. The PWM dimming frequency can be adjusted by varying pot RA2 using [Equation 2](#):

$$F_{PWM} = 6.66 \times 10^7 / (R_{A2} + R_{12}) \quad (\text{EQ. 2})$$

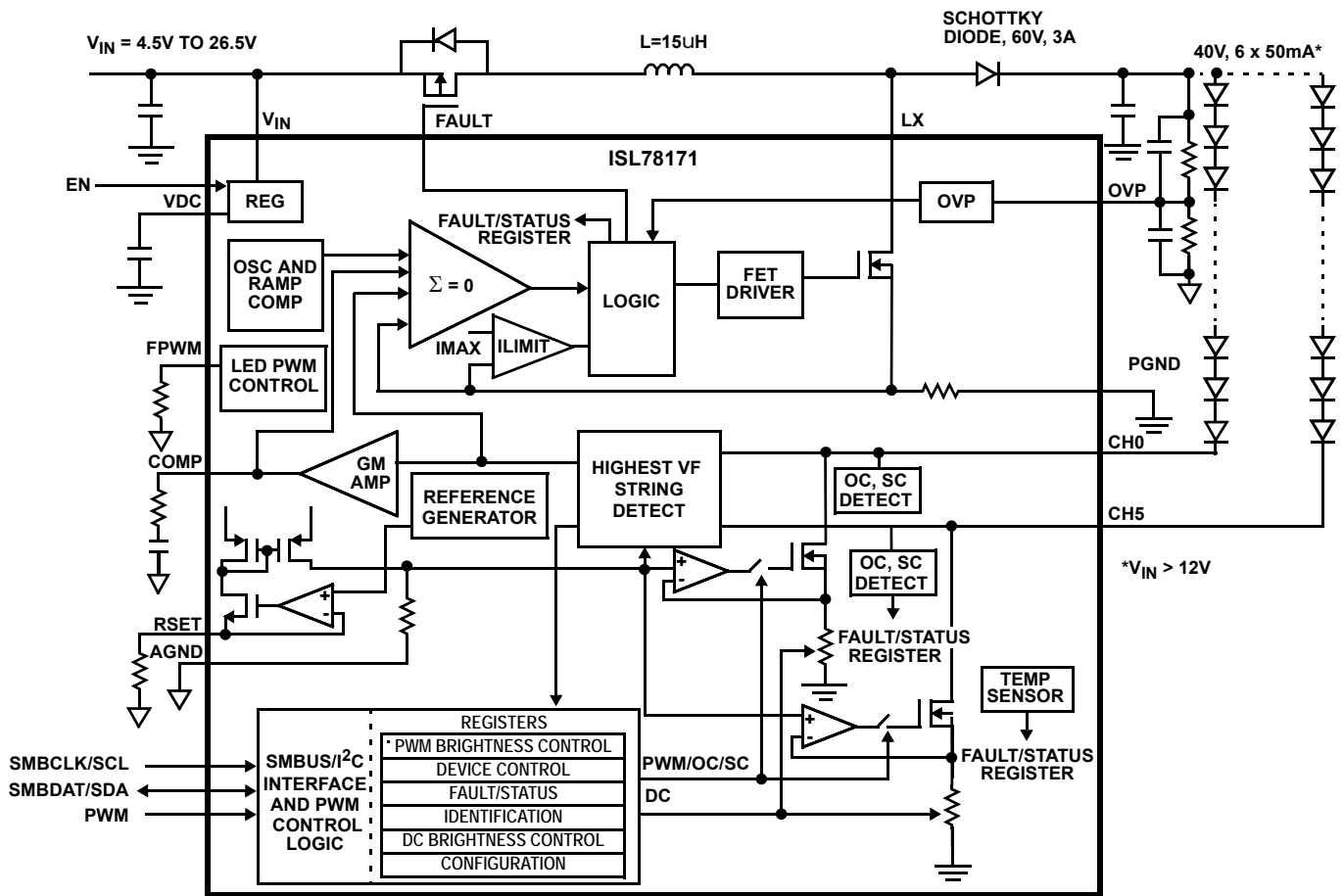

FIGURE 2. ISL78171 BLOCK DIAGRAM

## PCB Layout Recommendation

The PCB layout is very important for normal functioning of the ISL78171, to ensure the system works with low EMI. The main power loop is composed of the input capacitor, boost inductor, the output capacitor, the LX pin and the PGND pin. It is necessary to make the power loop as small as possible and the connecting traces among them should be direct, short and wide. The switching node of the boost converter (LX pins) and the traces connected to the node are noisy, so keep the low level signals away from these noisy traces. The input capacitor should be placed as close as possible to the VIN and GND pins. The ground of input and output capacitors should be connected as close as possible. The heat of the IC is mainly dissipated through the thermal pad. Maximizing the copper area connected to the thermal pad is preferable. In addition, a solid ground plane is helpful for better EMI performance. It is recommended to add at least 6 vias ground connection within the pad for the best thermal conduction. Keep the PGND plane and AGND plane separate and connect them at the thermal pad.

## EMI Considerations

The LX node switches at the VIN potential so its capacitance to GND should be made minimized. This is achieved by keeping the LX copper island as small as possible and by opening the copper GND area directly below it. This prevents injection of the switching frequency noise directly into the GND, and reduces the conducted EMI for the system. The evaluation board also has an input LC filter option on it ie., L2/L2A and C23. These components are not populated on the PCB but can be soldered in for the purpose of EMI evaluation if needed. The snubber R3 and C21 helps to reduce the peak voltage seen on the LX pin.

# ISL78171EVAL1Z Layout

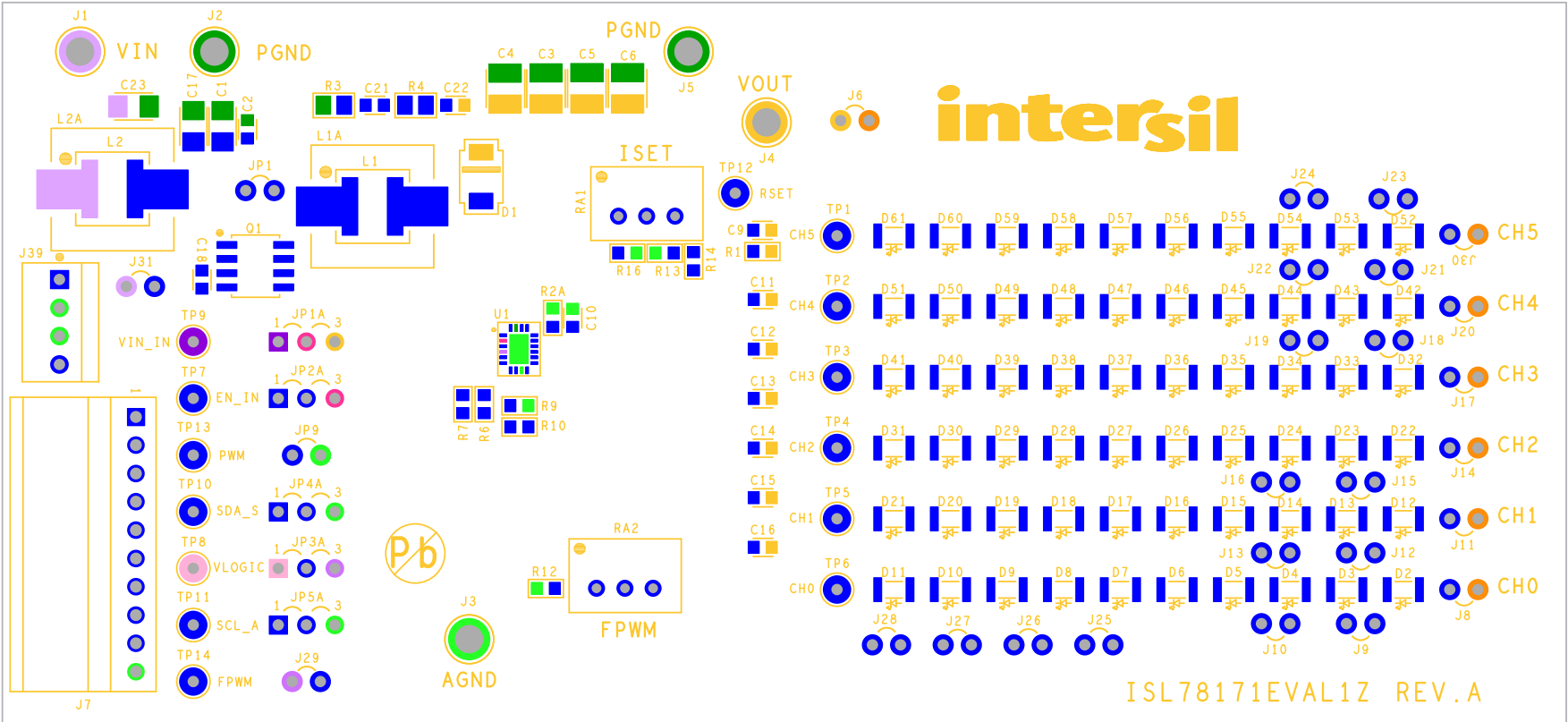

FIGURE 3. SILKSCREEN TOP

# ISL78171EVAL1Z Layout (Continued)

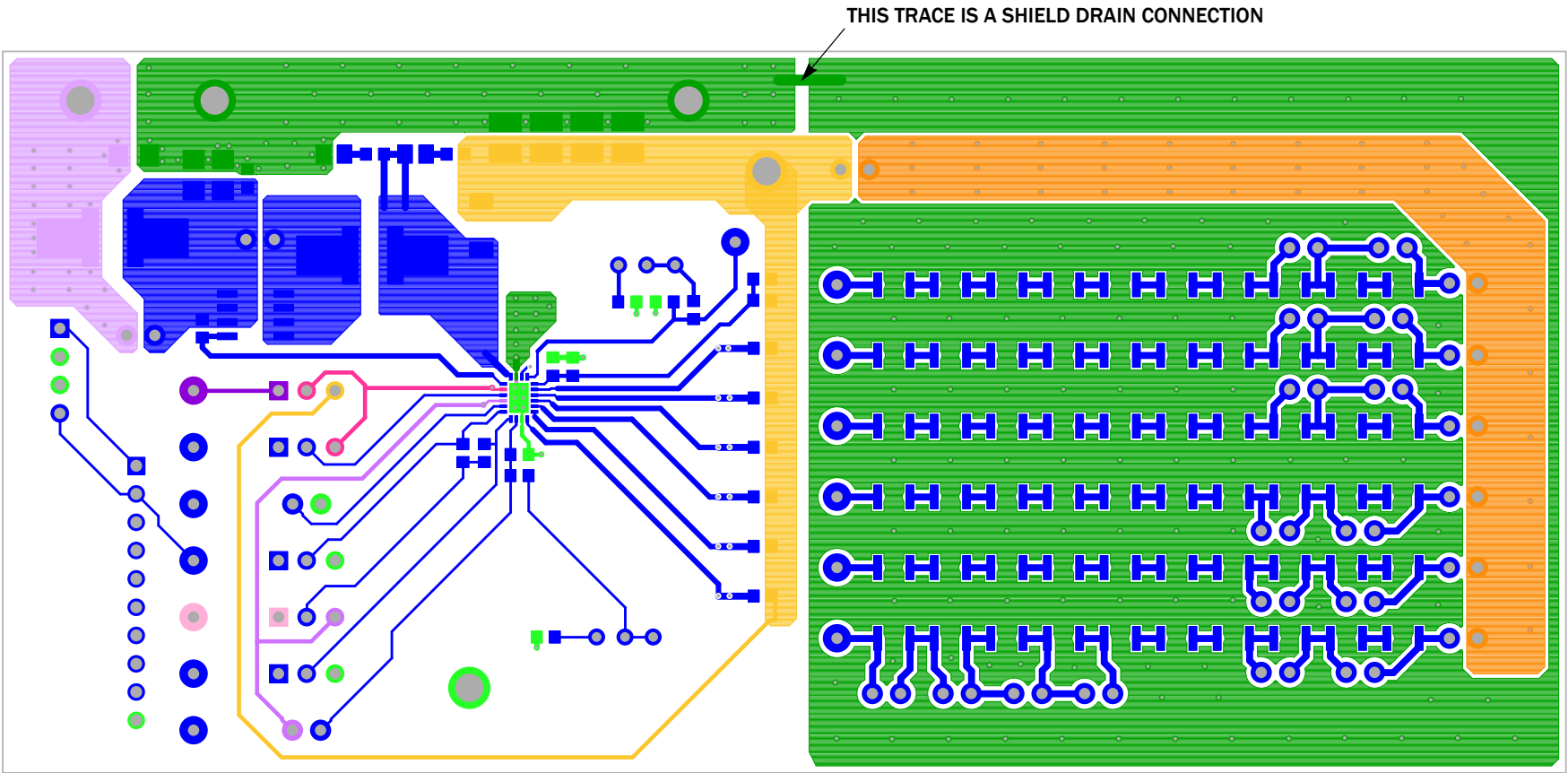

FIGURE 4. TOP LAYER

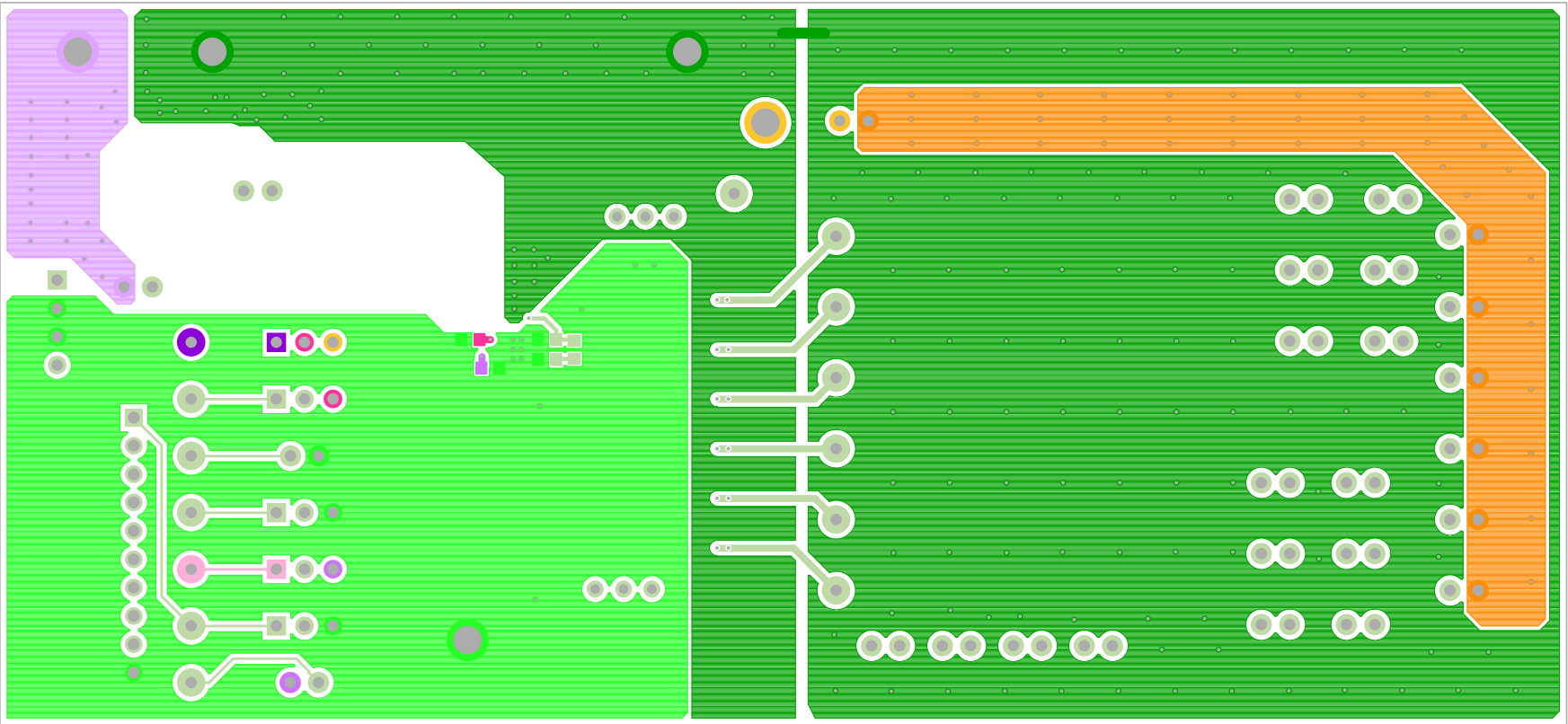

FIGURE 5. BOTTOM LAYER

**ISL78171EVAL1Z Layout** (Continued)

ISL78171EVAL1Z Layout (Continued)

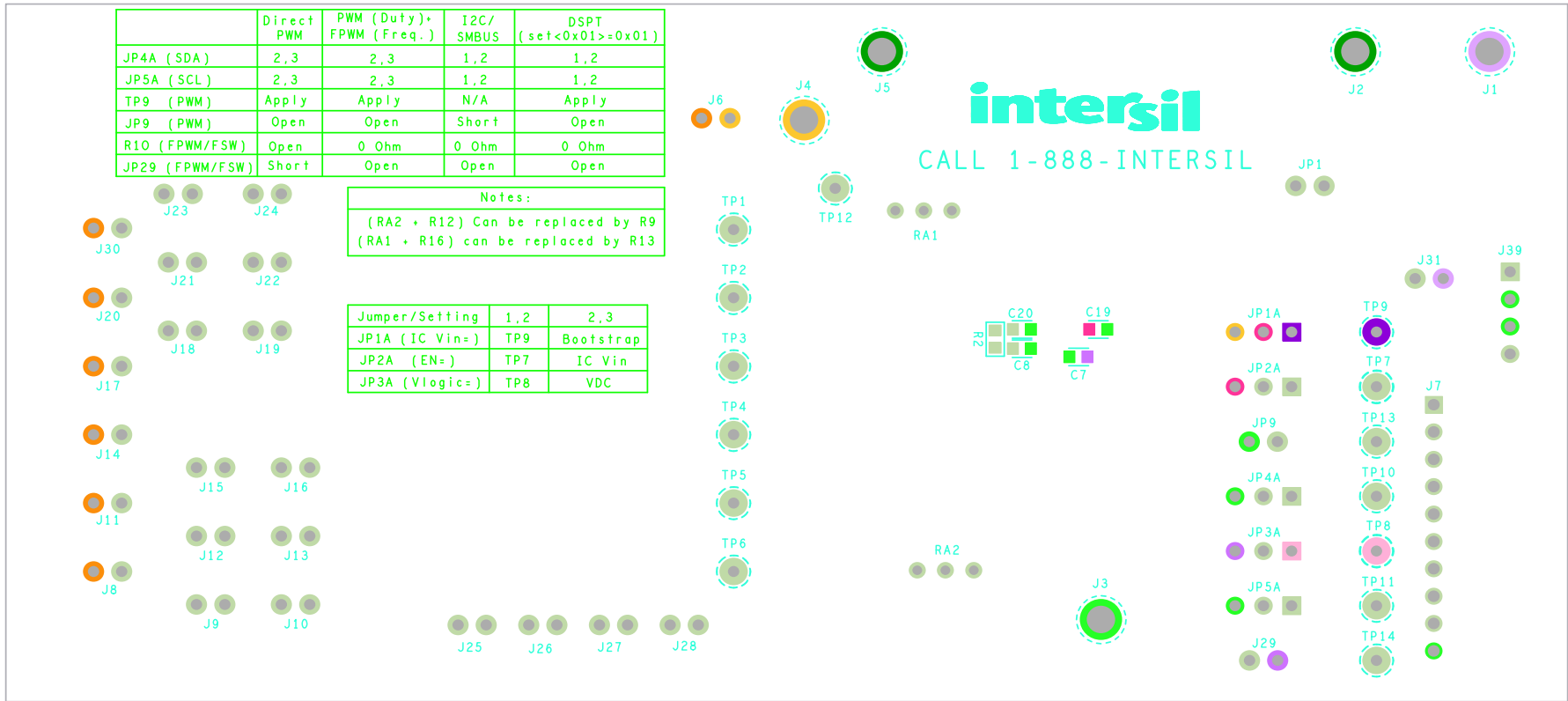

FIGURE 6. SILKSCREEN BOTTOM

# ISL78171EVAL1Z Evaluation Board Schematic

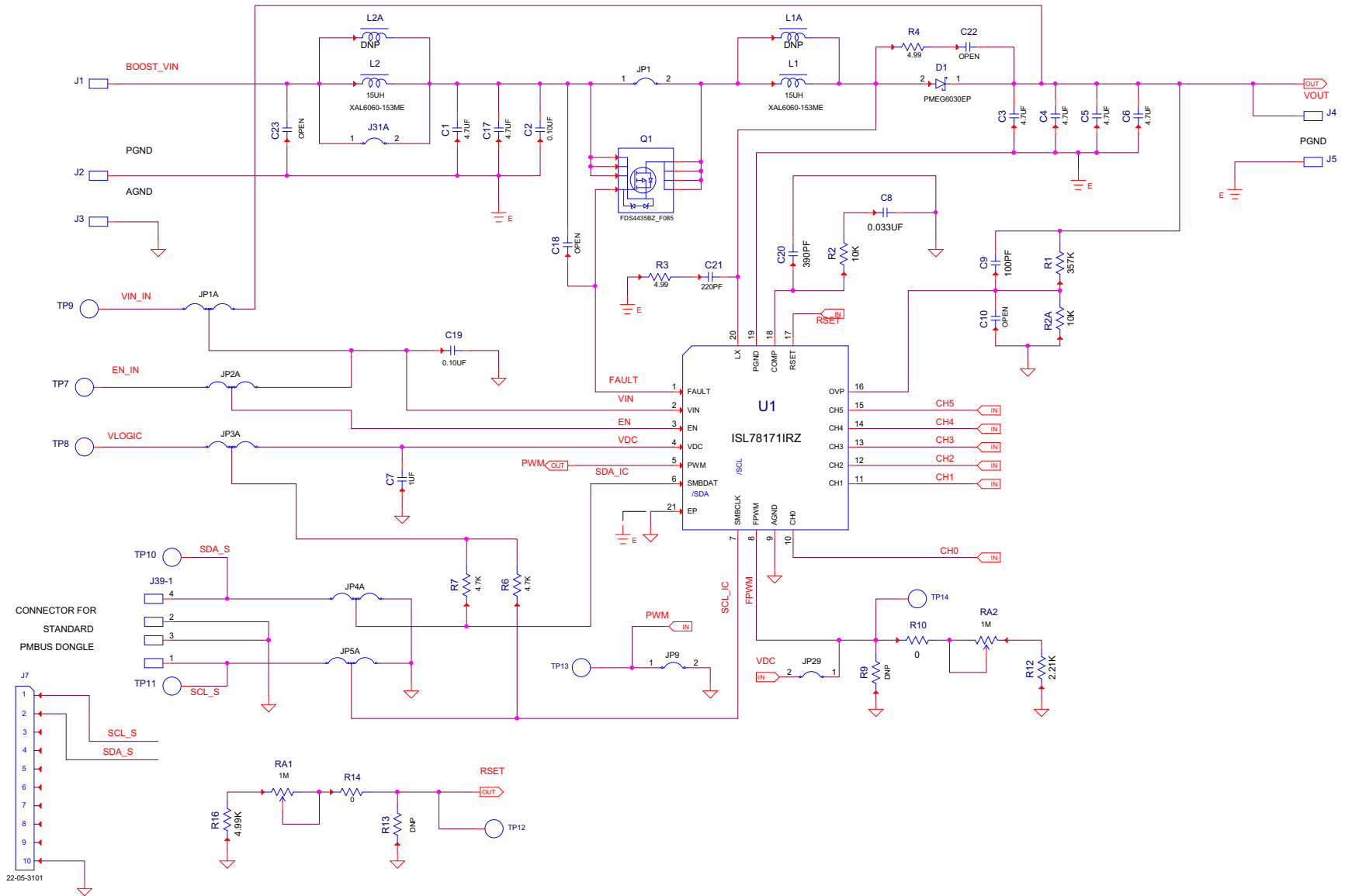

FIGURE 7. SCHEMATIC (PAGE 1)





## Bill of Materials

MANUFACTURER PART	QTY	UNITS	REFERENCE DESIGNATOR	DESCRIPTION	MANUFACTURER
ISL78171EVAL1ZREVAPCB	1	ea		PWB-PCB, ISL78171EVAL1Z, REVA, ROHS	IMAGINEERING INC
06031A101JAT2A	1	ea	C9	CAP, SMD, 0603, 100pF, 100V, 5%, NP0, ROHS	AVX
06033A391FAT2A	1	ea	C20	CAP, SMD, 0603, 390pF, 25V, 1%, COG, ROHS	AVX
C0603C33K3RACAUTO	1	ea	C8	CAP-AEC-Q200, SMD, 0603, 0.033μF, 25V, 10%, X7R, ROHS	KEMET
CGA3E2X7R1H104K080AA	2	ea	C2, C19	CAP-AEC-Q200, SMD, 0603, 0.1μF, 50V, 10%, X7R, ROHS	TDK
CGA5L3X7R1H475K160AE	2	ea	C1, C17	CAP-AEC-Q200, SMD, 1206, 4.7μF, 50V, 10%, X7R, ROHS	TDK
CGA6M3X7S2A475K200AE	4	ea	C3-C6	CAP-AEC-Q200, SMD, 1210, 4.7μF, 100V, 10%, X7S, ROHS	TDK
GCJ188R72A102KA01D	6	ea	C11-C16	CAP-AEC-Q200, SMD, 0603, 0.001μF, 100V, 10%, X7R, ROHS	MURATA
ECJ-1VB2A221K	1	ea	C21	CAP, SMD, 0603, 220pF, 100V, 10%, X7R, ROHS	PANASONIC
	0	ea	C22	CAP, SMD, 0603, DNP-PLACE HOLDER, ROHS	
LMK107B7105KAHT	1	ea	C7	CAP-AEC-Q200, SMD, 0603, 1.0μF, 10V, 10%, X7R, ROHS	TAIYO YUDEN
XAL6060-153MEC	2	ea	L1, L2	COIL-PWR INDUCT, SMD, 15μH, 20%, 39.7mΩ, 11Mhz, 6.5X6.3mm, ROHS	COILCRAFT
1514-2	5	ea	J1-J5	CONN-TURRET, TERMINAL POST, TH, ROHS	KEYSTONE
22-05-3101	1	ea	J7	CONN-HEADER, TH, 10P, 2.54mm, R/A, FRICTIONLOCK, ROHS	MOLEX
22-11-2042	1	ea	J39	CONN-HEADER, 1X4, SOLID, 2.54mm, VERTICAL, FRICTION LOCK, GOLD	MOLEX
5002	14	ea	TP1-TP14	CONN-MINI TEST POINT, VERTICAL, WHITE, ROHS	KEYSTONE
68000-236HLF	5	ea	JP1A-JP5A	CONN-HEADER, 1x3, BREAKAWY 1X36, 2.54mm, ROHS	BERG/FCI
69190-202HLF	27	ea	J6, J8-J31, JP1, JP9	CONN-HEADER, 1X2, RETENTIVE, 2.54mm, 0.230X 0.120, ROHS	BERG/FCI
PMEG6030EP, 115	1	ea	D1	DIODE-SCHOTTKY RECTIFIER, SMD, SOD128, 60V, 3A, ROHS	NXP SEMICONDUCTOR
LWY87C-T1U1-3K8L-Z	60	ea	D2-D61	LED, SMD, 2P, 3X1.2, WHITE/DIFFUSED, 3.2V, 20mA, 420mcd, ROHS	OSRAM
ISL78171ARZ-T	1	ea	U1	IC-6-CHANNEL LED DRIVER, 20P, QFN, ROHS	INTERSIL
FDS4435BZ_F085	1	ea	Q1	TRANSISTOR-MOS, P-CHANNEL, 8P, SOIC, -30V, -8.8A, ROHS	FAIRCHILD
3299W-1-105LF	2	ea	RA1, RA2	POT-TRIM, TH, 1M, 0.5W, 10%, 3P, 3/8SQ, 25TURN, ROHS	BOURNS
CRCW06030000Z0EA	2	ea	R10, R14	RES, SMD, AEC-Q200, 0603, 0Ω, 1/10W, TF, ROHS	VISHAY
CRCW060310K0FKEA	2	ea	R2, R2A	RES-AEC-Q200, SMD, 0603, 10k, 1/10W, 1%, TF, ROHS	VISHAY/DALE
CRCW06032K21FKEA	1	ea	R12	RES-AEC-Q200, SMD, 0603, 2.21k, 1/10W, 1%, TF, ROHS	VISHAY/DALE

**Bill of Materials (Continued)**

MANUFACTURER PART	QTY	UNITS	REFERENCE DESIGNATOR	DESCRIPTION	MANUFACTURER
CRCW0603357KFKEA	1	ea	R1	RES-AEC-Q200, SMD, 0603, 357k, 1/10W, 1%, TF, ROHS	VISHAY/DALE
CRCW06034K70FKEA	2	ea	R6, R7	RES-AEC-Q200, SMD, 0603, 4.7k, 1/10W, 1%, TF, ROHS	VISHAY/DALE
CRCW06034K99FKEA	1	ea	R16	RES-AEC-Q200, SMD, 0603, 4.99k, 1/10W, 1%, TF, ROHS	VISHAY/DALE
RC0805FR-074R99L	2	ea	R3, R4	RES, SMD, 0805, 4.99Ω, 1/8W, 1%, TF, ROHS	YAGEO
SJ-5003SPBL	4	ea	Bottom four corners	BUMPONS, 44inW x 20inH, DOMETOP, BLACK	3M
212403-013	1	ea	Place assy in bag	BAG, STATIC, 5X8, ZIPLOC, ROHS	INTERSIL
	0	ea	C10, C18 (0603 AUTO-AEC-Q200)	DO NOT POPULATE OR PURCHASE	
	0	ea	C23 (CGA5L3X7R1H475 K160AE)	DO NOT POPULATE OR PURCHASE	
	0	ea	L1A, L2A (SRP1038A-150M)	DO NOT POPULATE OR PURCHASE	
	0	ea	R9, R13 (0603 AUTO-AEC-Q200)	DO NOT POPULATE OR PURCHASE	

# Typical Performance Curves

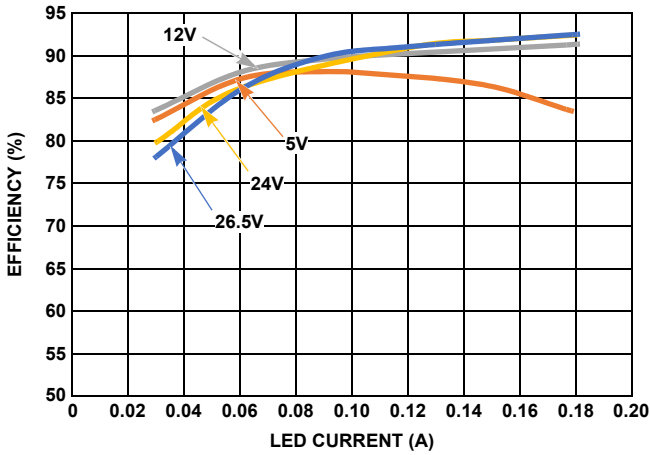

FIGURE 9. EFFICIENCY vs LED CURRENT AT LX  
FREQUENCY = 600kHz AT -40°C vs  $V_{IN}$

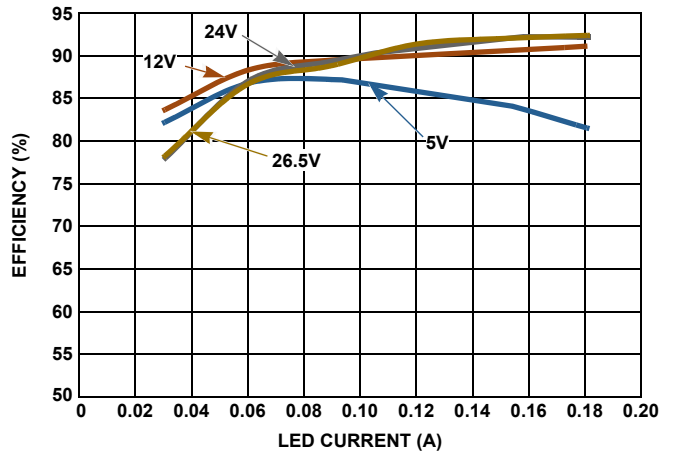

FIGURE 10. EFFICIENCY vs LED CURRENT AT LX  
FREQUENCY = 600kHz AT 25°C vs  $V_{IN}$

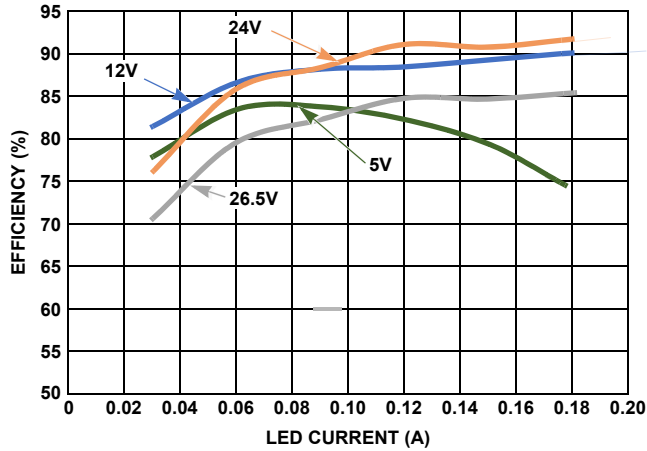

FIGURE 11. EFFICIENCY vs LED CURRENT AT LX  
FREQUENCY = 600kHz AT +105°C vs  $V_{IN}$

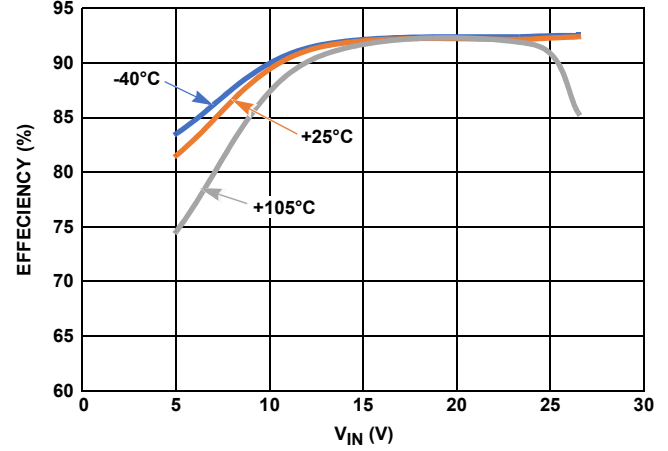

FIGURE 12. EFFICIENCY vs INPUT VOLTAGE AT LX  
FREQUENCY = 600kHz vs  $V_{IN}$

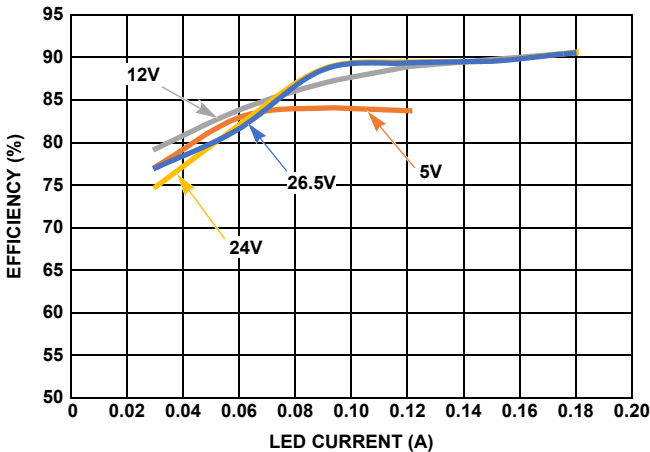

FIGURE 13. EFFICIENCY vs LED CURRENT AT LX  
FREQUENCY = 1.2MHz AT -40°C vs  $V_{IN}$

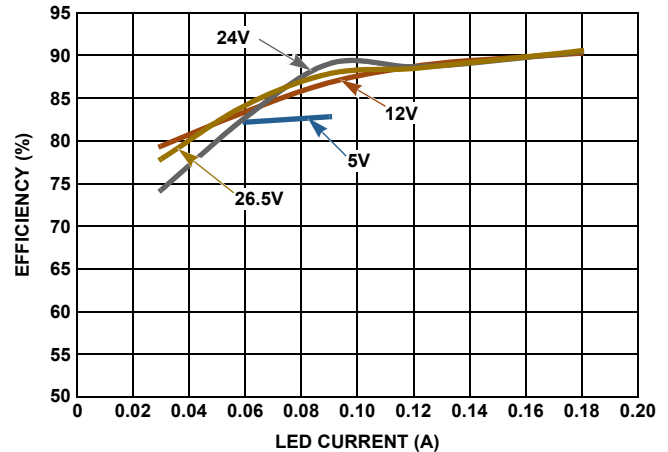
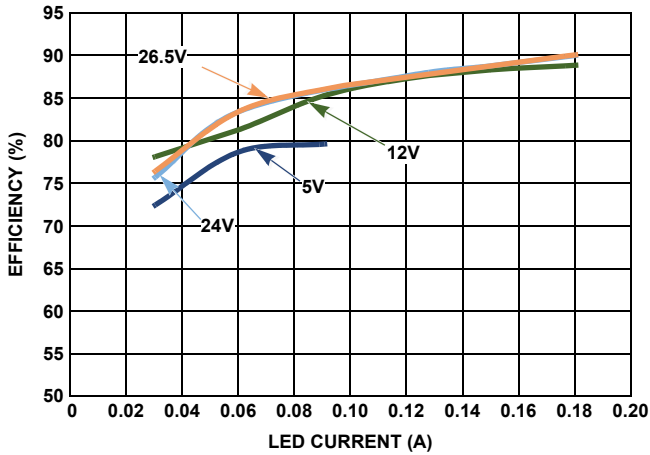
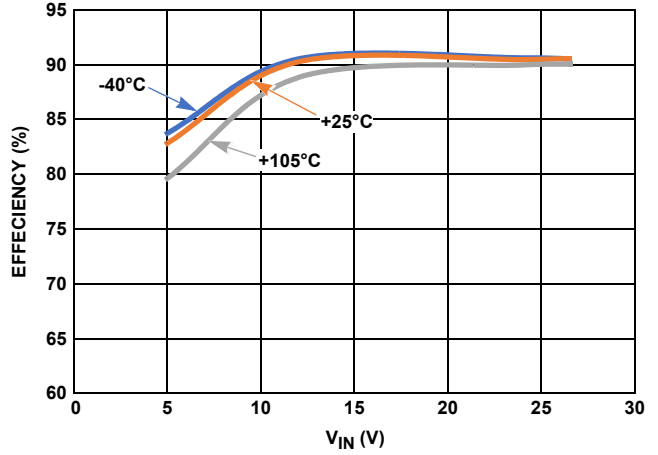

FIGURE 14. EFFICIENCY vs LED CURRENT AT LX  
FREQUENCY = 1.2MHz AT +25°C vs  $V_{IN}$

**Typical Performance Curves** (Continued)



**FIGURE 15. EFFICIENCY vs LED CURRENT AT LX**  
 FREQUENCY = 1.2MHz AT +105°C vs  $V_{IN}$



**FIGURE 16. EFFICIENCY vs INPUT VOLTAGE AT LX**  
 FREQUENCY = 1.2MHz vs  $V_{IN}$

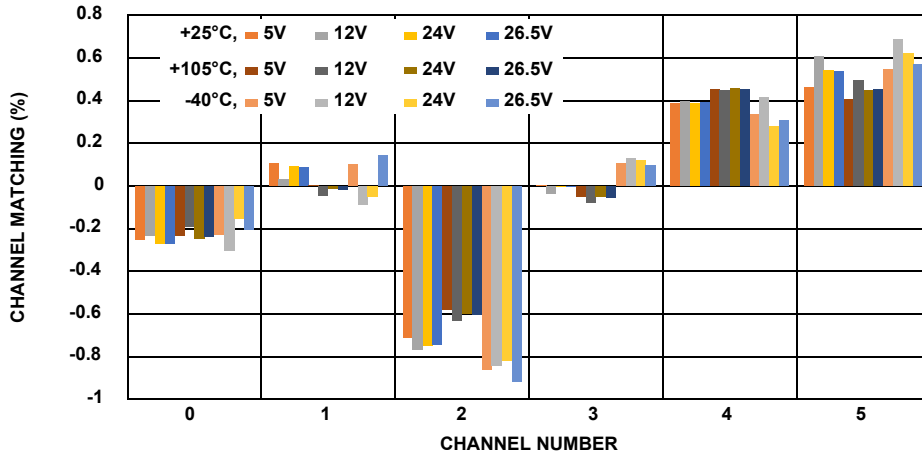

**FIGURE 17. CHANNEL-TO-CHANNEL CURRENT MATCHING, 600kHz vs  $V_{IN}$**

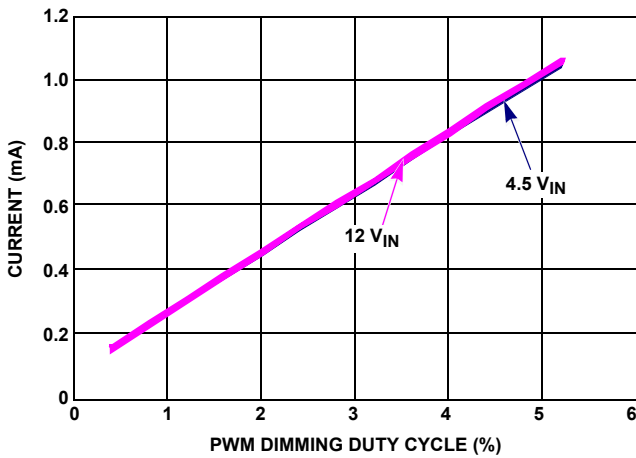

**FIGURE 18. CURRENT LINEARITY vs LOW LEVEL PWM DIMMING**  
 DUTY CYCLE vs  $V_{IN}$

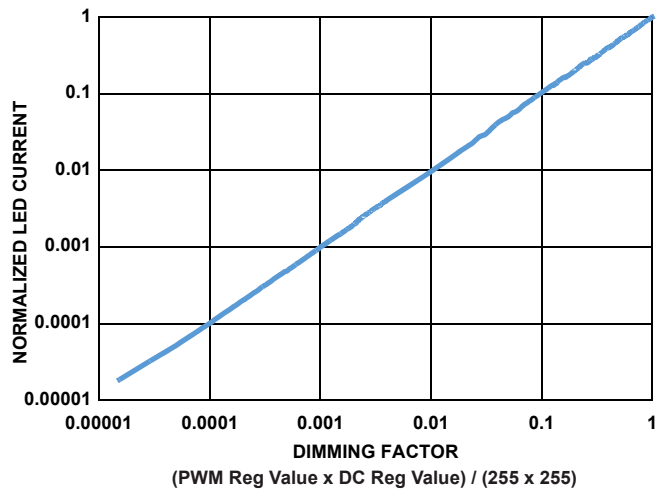

**FIGURE 19. NORMALIZED LED CURRENT vs. DIMMING FACTOR,**  
 (MEASURED AT  $I_{LED} = 20mA$ )

## Notice

1. Descriptions of circuits, software and other related information in this document are provided only to illustrate the operation of semiconductor products and application examples. You are fully responsible for the incorporation or any other use of the circuits, software, and information in the design of your product or system. Renesas Electronics disclaims any and all liability for any losses and damages incurred by you or third parties arising from the use of these circuits, software, or information.
2. Renesas Electronics hereby expressly disclaims any warranties against and liability for infringement or any other claims involving patents, copyrights, or other intellectual property rights of third parties, by or arising from the use of Renesas Electronics products or technical information described in this document, including but not limited to, the product data, drawings, charts, programs, algorithms, and application examples.
3. No license, express, implied or otherwise, is granted hereby under any patents, copyrights or other intellectual property rights of Renesas Electronics or others.
4. You shall not alter, modify, copy, or reverse engineer any Renesas Electronics product, whether in whole or in part. Renesas Electronics disclaims any and all liability for any losses or damages incurred by you or third parties arising from such alteration, modification, copying or reverse engineering.
5. Renesas Electronics products are classified according to the following two quality grades: "Standard" and "High Quality". The intended applications for each Renesas Electronics product depends on the product's quality grade, as indicated below.  
"Standard": Computers; office equipment; communications equipment; test and measurement equipment; audio and visual equipment; home electronic appliances; machine tools; personal electronic equipment; industrial robots; etc.  
"High Quality": Transportation equipment (automobiles, trains, ships, etc.); traffic control (traffic lights); large-scale communication equipment; key financial terminal systems; safety control equipment; etc.  
Unless expressly designated as a high reliability product or a product for harsh environments in a Renesas Electronics data sheet or other Renesas Electronics document, Renesas Electronics products are not intended or authorized for use in products or systems that may pose a direct threat to human life or bodily injury (artificial life support devices or systems; surgical implantations; etc.), or may cause serious property damage (space system; undersea repeaters; nuclear power control systems; aircraft control systems; key plant systems; military equipment; etc.). Renesas Electronics disclaims any and all liability for any damages or losses incurred by you or any third parties arising from the use of any Renesas Electronics product that is inconsistent with any Renesas Electronics data sheet, user's manual or other Renesas Electronics document.
6. When using Renesas Electronics products, refer to the latest product information (data sheets, user's manuals, application notes, "General Notes for Handling and Using Semiconductor Devices" in the reliability handbook, etc.), and ensure that usage conditions are within the ranges specified by Renesas Electronics with respect to maximum ratings, operating power supply voltage range, heat dissipation characteristics, installation, etc. Renesas Electronics disclaims any and all liability for any malfunctions, failure or accident arising out of the use of Renesas Electronics products outside of such specified ranges.
7. Although Renesas Electronics endeavors to improve the quality and reliability of Renesas Electronics products, semiconductor products have specific characteristics, such as the occurrence of failure at a certain rate and malfunctions under certain use conditions. Unless designated as a high reliability product or a product for harsh environments in a Renesas Electronics data sheet or other Renesas Electronics document, Renesas Electronics products are not subject to radiation resistance design. You are responsible for implementing safety measures to guard against the possibility of bodily injury, injury or damage caused by fire, and/or danger to the public in the event of a failure or malfunction of Renesas Electronics products, such as safety design for hardware and software, including but not limited to redundancy, fire control and malfunction prevention, appropriate treatment for aging degradation or any other appropriate measures. Because the evaluation of microcomputer software alone is very difficult and impractical, you are responsible for evaluating the safety of the final products or systems manufactured by you.
8. Please contact a Renesas Electronics sales office for details as to environmental matters such as the environmental compatibility of each Renesas Electronics product. You are responsible for carefully and sufficiently investigating applicable laws and regulations that regulate the inclusion or use of controlled substances, including without limitation, the EU RoHS Directive, and using Renesas Electronics products in compliance with all these applicable laws and regulations. Renesas Electronics disclaims any and all liability for damages or losses occurring as a result of your noncompliance with applicable laws and regulations.
9. Renesas Electronics products and technologies shall not be used for or incorporated into any products or systems whose manufacture, use, or sale is prohibited under any applicable domestic or foreign laws or regulations. You shall comply with any applicable export control laws and regulations promulgated and administered by the governments of any countries asserting jurisdiction over the parties or transactions.
10. It is the responsibility of the buyer or distributor of Renesas Electronics products, or any other party who distributes, disposes of, or otherwise sells or transfers the product to a third party, to notify such third party in advance of the contents and conditions set forth in this document.
11. This document shall not be reprinted, reproduced or duplicated in any form, in whole or in part, without prior written consent of Renesas Electronics.
12. Please contact a Renesas Electronics sales office if you have any questions regarding the information contained in this document or Renesas Electronics products.  
(Note 1) "Renesas Electronics" as used in this document means Renesas Electronics Corporation and also includes its directly or indirectly controlled subsidiaries.  
(Note 2) "Renesas Electronics product(s)" means any product developed or manufactured by or for Renesas Electronics.

(Rev.4.0-1 November 2017)



### SALES OFFICES

Renesas Electronics Corporation

<http://www.renesas.com>

Refer to "<http://www.renesas.com/>" for the latest and detailed information.

**Renesas Electronics America Inc.**  
1001 Murphy Ranch Road, Milpitas, CA 95035, U.S.A.  
Tel: +1-408-432-8888, Fax: +1-408-434-5351

**Renesas Electronics Canada Limited**  
9251 Yonge Street, Suite 8309 Richmond Hill, Ontario Canada L4C 9T3  
Tel: +1-905-237-2004

**Renesas Electronics Europe Limited**  
Dukes Meadow, Millboard Road, Bourne End, Buckinghamshire, SL8 5FH, U.K  
Tel: +44-1628-651-700, Fax: +44-1628-651-804

**Renesas Electronics Europe GmbH**  
Arcadiastrasse 10, 40472 Düsseldorf, Germany  
Tel: +49-211-6503-0, Fax: +49-211-6503-1327

**Renesas Electronics (China) Co., Ltd.**  
Room 1709 Quantum Plaza, No.27 ZhichunLu, Haidian District, Beijing, 100191 P. R. China  
Tel: +86-10-8235-1155, Fax: +86-10-8235-7679

**Renesas Electronics (Shanghai) Co., Ltd.**  
Unit 301, Tower A, Central Towers, 555 Langao Road, Putuo District, Shanghai, 200333 P. R. China  
Tel: +86-21-2226-0888, Fax: +86-21-2226-0999

**Renesas Electronics Hong Kong Limited**  
Unit 1601-1611, 16/F., Tower 2, Grand Century Place, 193 Prince Edward Road West, Mongkok, Kowloon, Hong Kong  
Tel: +852-2265-6688, Fax: +852-2886-9022

**Renesas Electronics Taiwan Co., Ltd.**  
13F, No. 363, Fu Shing North Road, Taipei 10543, Taiwan  
Tel: +886-2-8175-9600, Fax: +886-2-8175-9670

**Renesas Electronics Singapore Pte. Ltd.**  
80 Bendemeer Road, Unit #06-02 Hyflux Innovation Centre, Singapore 339949  
Tel: +65-6213-0200, Fax: +65-6213-0300

**Renesas Electronics Malaysia Sdn.Bhd.**  
Unit 1207, Block B, Menara Amcorp, Amcorp Trade Centre, No. 18, Jln Persiaran Barat, 46050 Petaling Jaya, Selangor Darul Ehsan, Malaysia  
Tel: +60-3-7955-9390, Fax: +60-3-7955-9510

**Renesas Electronics India Pvt. Ltd.**  
No.777C, 100 Feet Road, HAL 2nd Stage, Indiranagar, Bangalore 560 038, India  
Tel: +91-80-67208700, Fax: +91-80-67208777

**Renesas Electronics Korea Co., Ltd.**  
17F, KAMCO Yangjae Tower, 262, Gangnam-daero, Gangnam-gu, Seoul, 06265 Korea  
Tel: +82-2-558-3737, Fax: +82-2-558-5338