

ISL9444EVAL3Z

Evaluation Board

AN1799
Rev 0.00
Dec 5, 2012

Introduction

ISL9444EVAL3Z consists of three PWM step-down synchronous converters, which features the triple PWM controller, ISL9444. The PWM1 delivers 5V output at 5A. PWM2 and PWM3 deliver 5V at 25A and 3.3V at 25A, respectively.

A power failure monitor and three independent enable pins accommodate variable power sequencing requirement. The Extbias option is provided to achieve low standby power.

Strong gate driver and adaptive deadtime control achieve excellent efficiency over 96%.

ISL9444 Key Features

- Wide input voltage range: 4.5V to 28V
- Use lower MOSFET's $r_{DS(ON)}$ for current sensing
- Extbias pin to save operating loss
- Power failure monitor
- Complete protection: overvoltage, overcurrent, thermal shutdown
- Three independent power-good indicators

Evaluation Board Specifications

TABLE 1. EVALUATION BOARD ELECTRICAL SPECIFICATIONS

SPEC	DESCRIPTION	MIN	TYP	MAX	UNIT
VIN	Input for PWM2 and PWM3	5.6	12	16	V
VOUT2	IOUT = 0A	4.75	5.0	5.25	V
VOUT3	IOUT = 0A	3.15	3.3	3.65	V
IOUT_2 IOUT_3	Output Current of PWM2 and PWM3	25			A
VIN2	Input for PWM1	5.6	12	16	V
VOUT1	IOUT = 0A	4.75	5	5.25	V
IOUT_1	Output Current of PWM1	6			A
Fsw			330		kHz
η	VIN = 12V, PWM1, 6A, EN2 = EN3 = GND		96		%
η	VIN = 12V, PWM1 at 6A, PWM 2 and PWM3 at 25A respectively		95.9		%

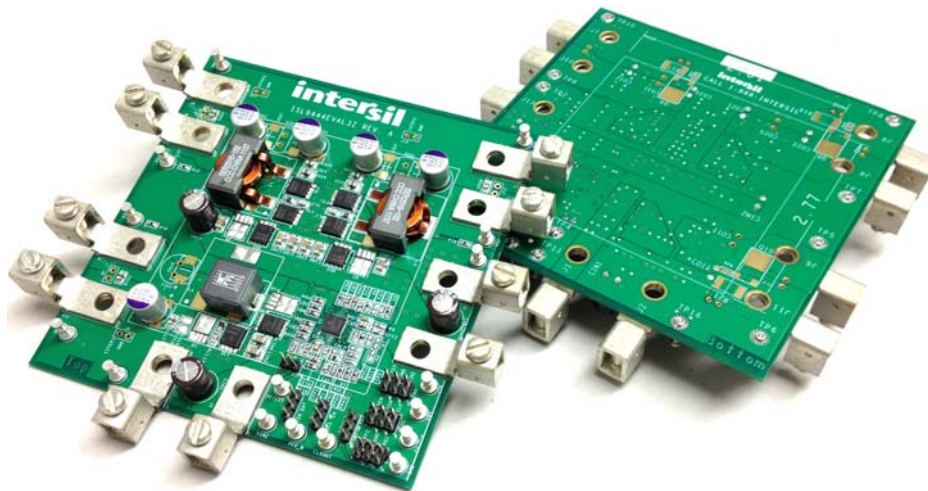

FIGURE 1. ISL9444EVAL3Z TOP AND BOTTOM VIEW

TABLE 2. RECOMMENDED COMPONENT SELECTION FOR QUICK EVALUATION FOR PWM CHANNEL

VOUT (V)	IOUT (A)	VIN (V)	Fsw(kHz) /R _T (kΩ)	MOSFET(s), LOWER, UPPER	RSEN	INDUCTOR (L, ISAT)	COUts	FEEDBACK RES (LOWER, UPPER, kΩ)	CFF
1.2	15	19 to 26.4	250/130	1XBSC059N04, 1XBSC059N04	2.0kΩ	4.7μH, 20A	270μF, OSCON, 16V and 2x1.0μF, ceramic	3.24, 52.3	1nF

NOTES:

1. Please select the output capacitor with a voltage rating higher than the output.
2. Please adjust R_{OCSET} accordingly.
3. Please contact [Intersil Sales](#) for assistance.

Recommended Equipment

The following equipment is recommended for evaluation:

- 0V to 20V power supply with 30A source current capability
- Electronic load capable of sinking 30A @ 20V
- Digital Multimeters (DMMs)
- 100MHz Quad-Trace Oscilloscope

Quick Test Setup

1. Ensure that the evaluation board is correctly connected to the power supply and the electronic load prior to applying any power. Please refer to Figure 2 for proper set-up.
2. Refer to Table 3 for jumper default positions. For set-up different than the default setting, please refer to the datasheet for details (ISL9444, [FN7665](#)).
3. Turn on the power supplies; $V_{IN} < 16V$; $V_{IN2} < 16V$
4. Adjust input voltage V_{IN} and V_{IN2} within the specified range and observe output voltage. The output voltage variation should be within 5%.
5. Adjust load current within specified range. The output voltage variation should be within 5%.

6. Use an oscilloscope to observe the output ripple voltage and phase node ringing. For accurate measurement, please refer to Figure 3 for proper probe set-up.
7. Optimization. Please refer to Table 2 on page 1 for optimization recommendation.

NOTE: All Test points are for voltage measurement or small signal only. Do not allow high current through these test points.

TABLE 3. JUMPER DEFAULT POSITIONS

JUMPER NAME	PFI	EN1	EN2	EN3	MODE
Positions	VIN	EN	PFO	EN2	CCM

Probe Set-up

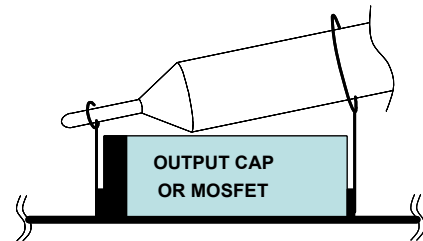

FIGURE 3. OSCILLOSCOPE PROBE SET-UP

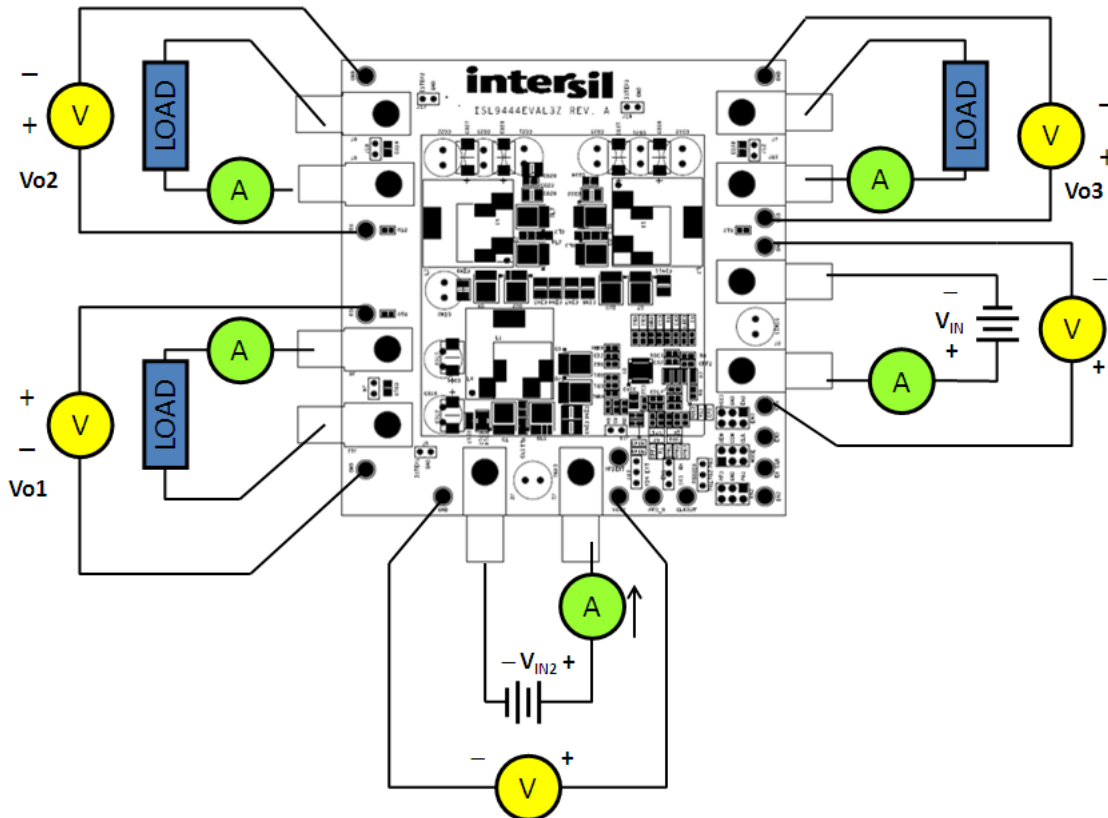

FIGURE 2. ISL9444EVAL3Z TEST SET-UP

Output Setting

The output voltage is set by the feedback resistor divider, R_{low} and R_{up} .

$$V_{OUT} = \frac{R_{low} + R_{up}}{R_{low}} \times 0.7V \quad (EQ. 1)$$

Where R_{low} is the resistor from FBx to GND, R_{up} is the resistor from VOx to FBx. Resistor R10, R12 and R13 are resistor jumpers for loop gain measurement. They are not must-to-have components. It is recommended to use 50Ω for loop gain measurement.

Remote Sensing

By sensing the positive rail from load, significant voltage drop along the PCB trace can be compensated.

For applications with load far from the ISL9444, it is likely that the remote sensing trace picks up noise from the environment. To prevent noise being coupled into the feedback loop, it is recommended to connect the phase boosting capacitors, C_{ff1} , C_{ff2} and C_{ff3} to the local output capacitors.

For applications that C_{ffx} is not used for phase boosting, a pair of C_{ff} and C_p is recommended for remote sensing. Please set C_{ff} and C_p according to Equation 2.

$$R_{low} \cdot C_p = R_{up} \cdot C_{ff} \quad (EQ. 2)$$

In case the remote sensing trace become open-circuit, a default resistor is recommended to connect the resistor R_{up} to the local VOUT.

The ISL9444 does not provide dedicated differential amplifier for remote sensing.

Transient Load Test

The ISL9444EVAL3Z provides optional load transient test footprints for high di/dt load transient response tests. Please refer to Figure 4 for the load transient circuit of PWM1.

1. Select a powerpak or SOIC8 MOSFET with V_{DSS} breakdown greater than V_{OUT} . Select a current sensing resistor. For accurate current sensing, please use tighter than 5% tolerance resistors. To alleviate thermal stress, use 0.1Ω or smaller resistance. For 25A application, a 10mΩ precision resistor is recommended. Use an oscilloscope to monitor voltage across R21 and the output voltage.
2. Install the load transient circuit as indicated in the "Schematic (Optional Circuits and Optional Footprints)" on page 8. R18, R20 and R22 are 10kΩ resistors for MOSFET gate discharging.
3. Apply pulse square waveform to the gate of the load transient test MOSFET, Q10. The duty cycle of the pulse waveform should be small (<5%) to limit thermal stress on current sensing resistor and the MOSFETs. Set the amplitude of the square waveform below 0.5V at the beginning.
4. The amplitude of the square waveform set the current step amplitude. Slowly increase the amplitude of the square waveform and monitor the current amplitude. Adjust the square waveform rising and falling time to set the current step slew rate.
5. Monitor overshoot and undershoot at the corresponding output.

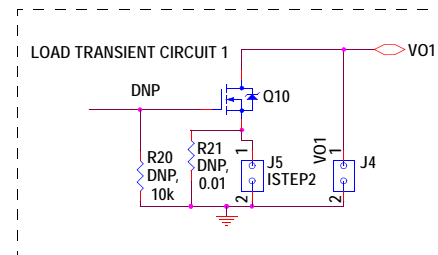

FIGURE 4. LOAD TRANSIENT SET-UP

Typical Performance Curves

Oscilloscope Plots were taken at $V_{IN} = 12V$, $V_{IN2} = 12V$ and jumpers in default positions, unless otherwise noted.

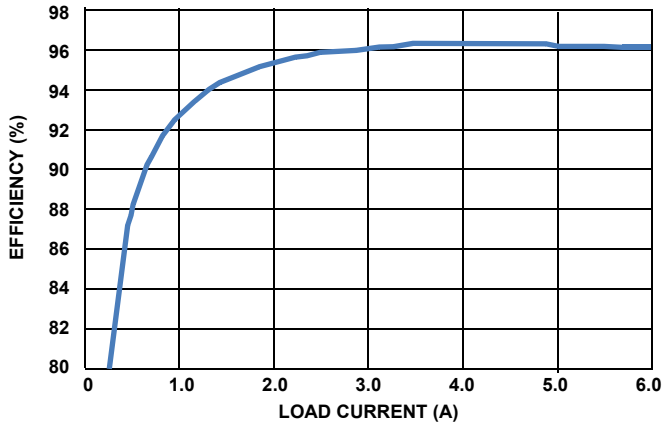

FIGURE 5. EFFICIENCY vs LOAD CURRENT FOR PWM1 (EN2 = EN3 = GND)

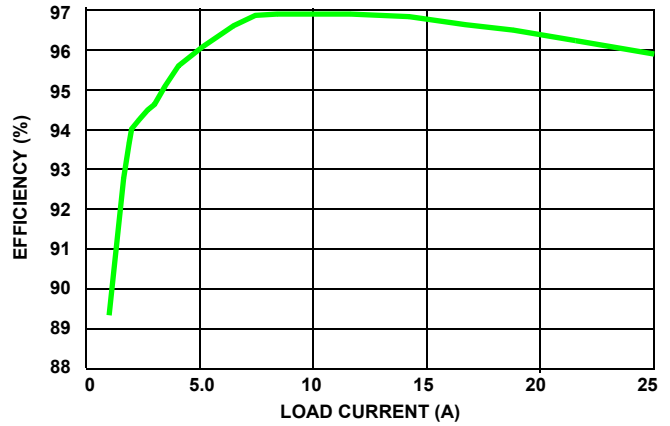

FIGURE 6. TOTAL EFFICIENCY vs LOAD PWM2 AND PWM3 (EN/SS1 IS GROUNDED)

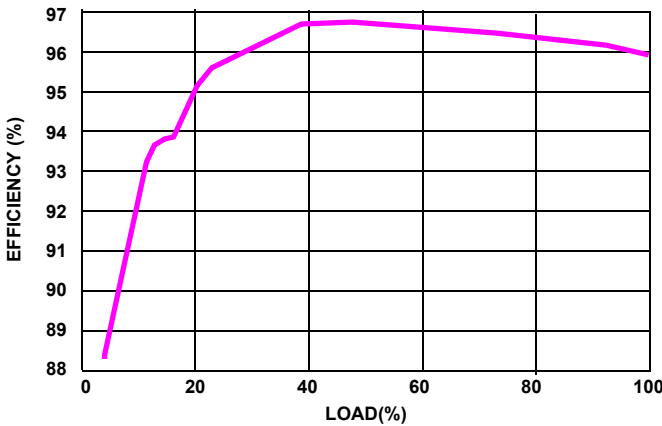

FIGURE 7. EFFICIENCY vs LOAD(%) FOR ALL PWMs (6A, 25A, 25A)

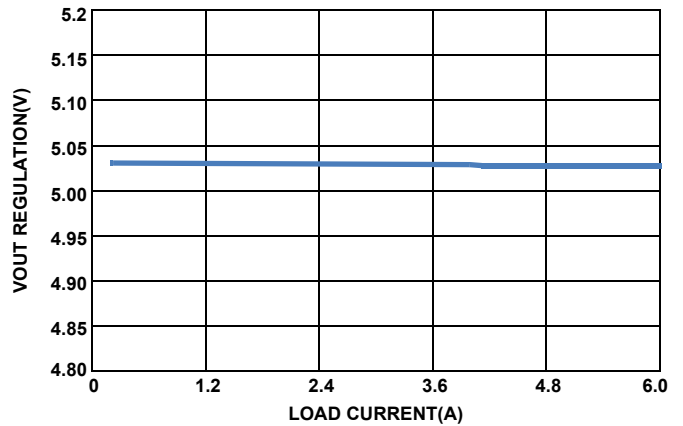

FIGURE 8. LOAD REGULATION OF PWM1 ($V_{IN2} = 12V$)

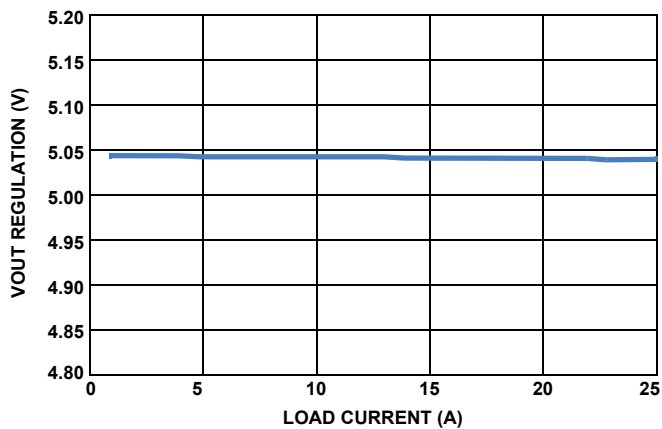

FIGURE 9. LOAD REGULATION of PWM2 ($V_{IN} = 12V$)

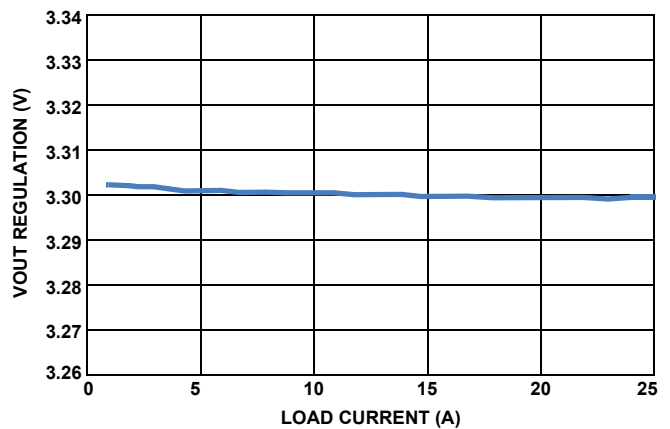

FIGURE 10. LOAD REGULATION of PWM3 ($V_{IN} = 12V$)

Typical Performance Curves

Oscilloscope Plots were taken at $V_{IN} = 12V$, $V_{IN2} = 12V$ and jumpers in default positions, unless otherwise noted. (Continued)

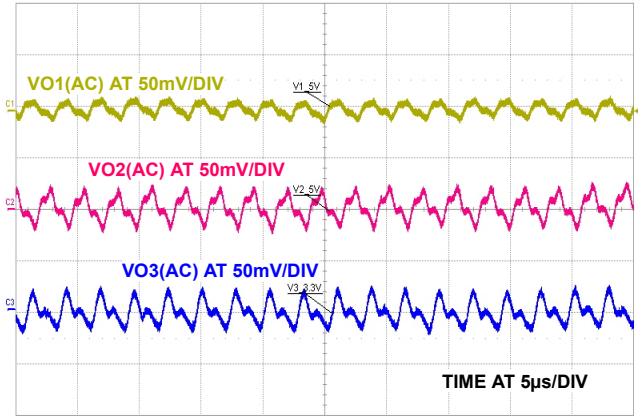

FIGURE 11. OUTPUT RIPPLE ($V_{IN} = 12V$, FULL LOAD, 20MHz BW)

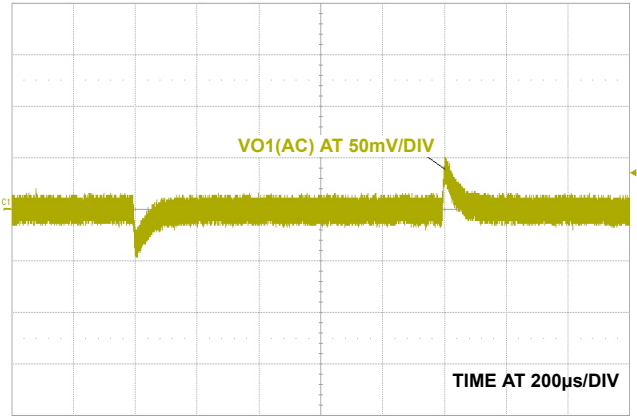

FIGURE 12. LOAD TRANSIENT RESPONSE of PWM1 (1.25A TO 3.75A AT 2A/µs)

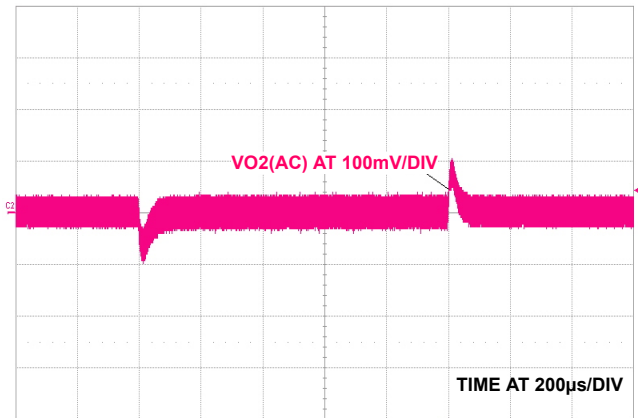

FIGURE 13. LOAD TRANSIENT RESPONSE of PWM2 (6.25A TO 18.75A AT 2A/µs)

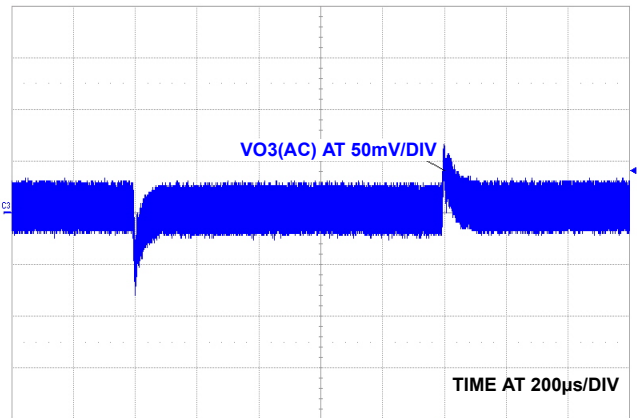

FIGURE 14. LOAD TRANSIENT RESPONSE OF PWM1 (6.25A TO 18.75A AT 2A/µs)

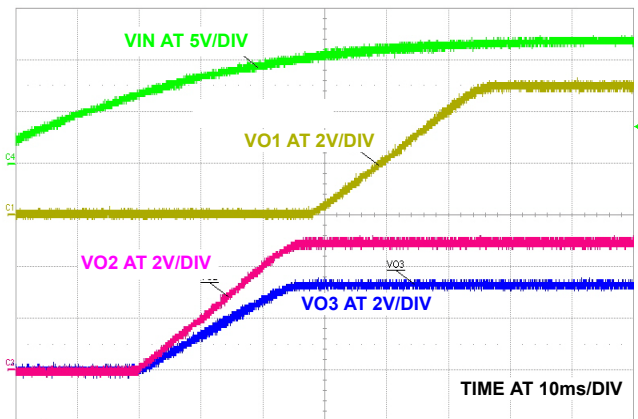

FIGURE 15. POWER-UP SEQUENCING (DEFAULT CONFIGURATION)

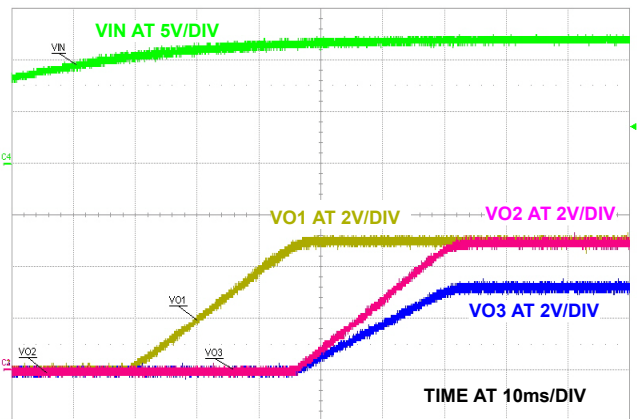

FIGURE 16. POWER-UP SEQUENCING (EN2 = PG00D1)

Typical Performance Curves

Oscilloscope Plots were taken at $V_{IN} = 12V$, $V_{IN2} = 12V$ and jumpers in default positions, unless otherwise noted. (Continued)

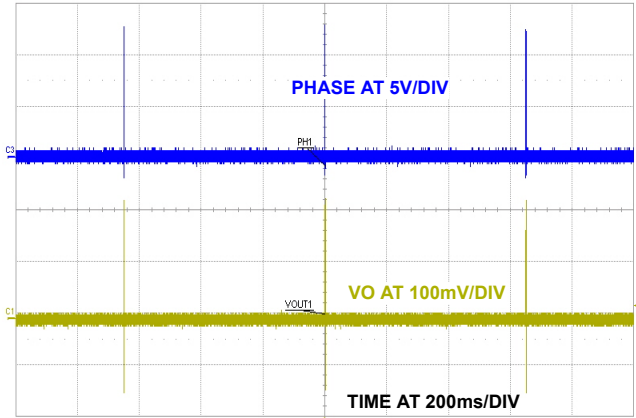

FIGURE 17. OVERCURRENT PROTECTION RESPONSE OF PWM1

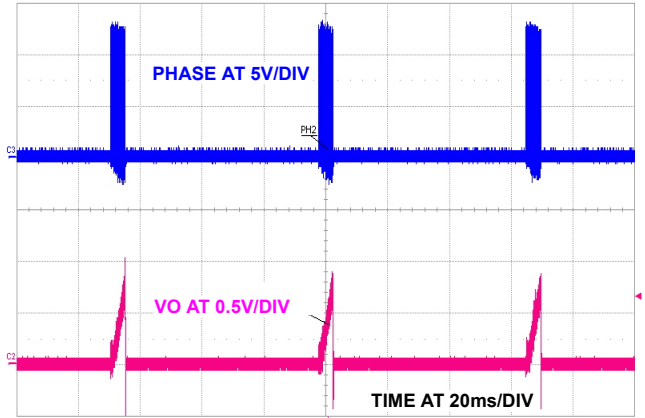
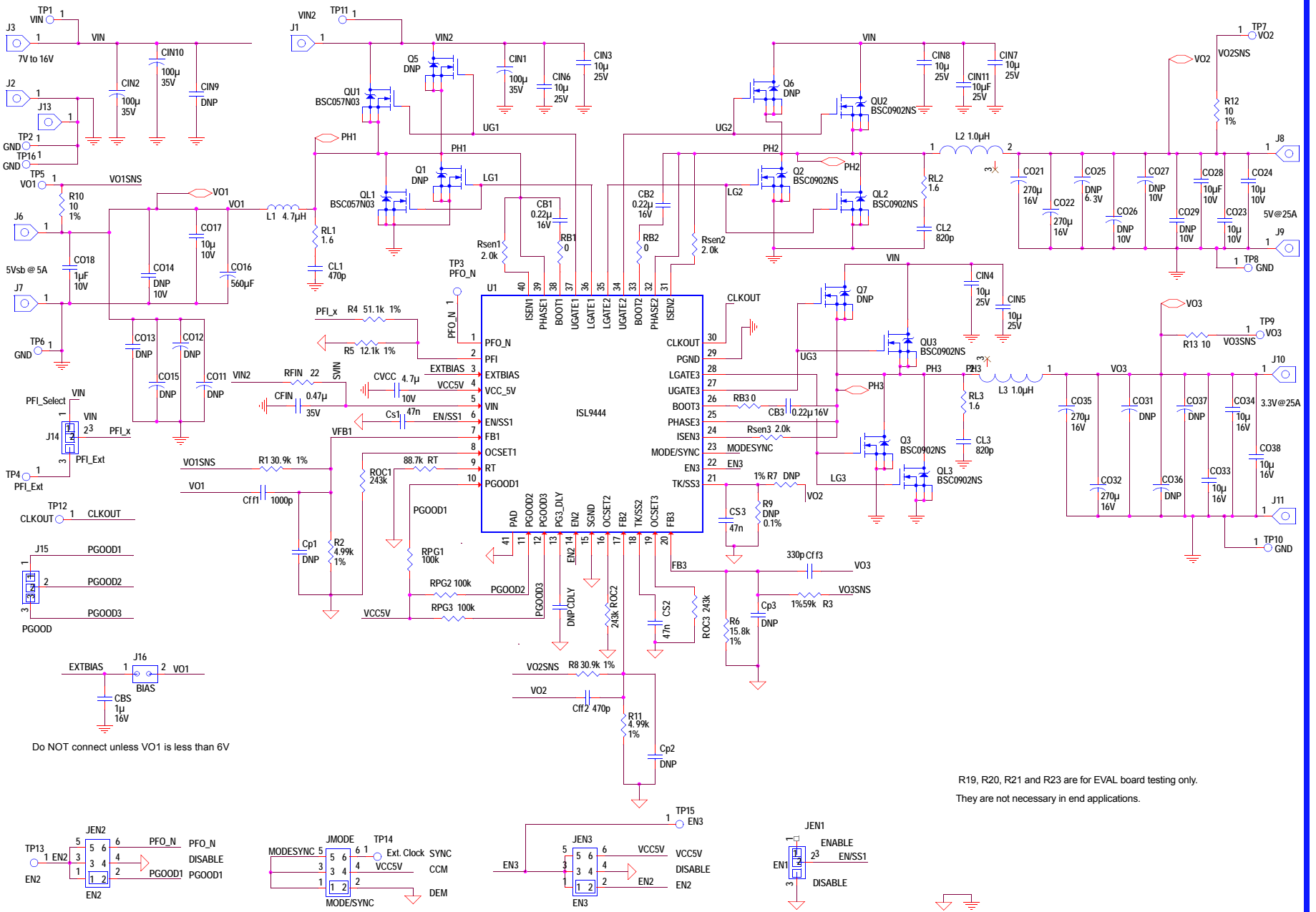

FIGURE 18. OVERCURRENT PROTECTION OF PWM2

Schematic, Main



Do NOT connect unless VO1 is less than 6V

R19, R20, R21 and R23 are for EVAL board testing only. They are not necessary in end applications.

PWM3 is configured to track the VO2 by default.

Schematic (Optional Circuits and Optional Footprints)

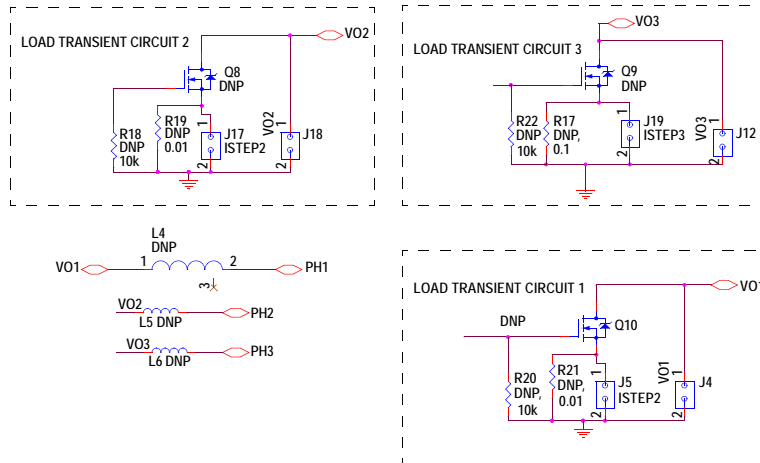

Bill of Materials

ITEM	QTY	REFERENCE	VALUE	DESCRIPTION	PART #	VENDOR
ESSENTIAL COMPONENTS						
1	1	CBS	1 μ	Ceramic CAP, X5R, 16V, SM0603	Generic	Generic
2	3	CB1, CB2, CB3	0.22 μ	Ceramic CAP, X5R, 16V, SM0603	Generic	Generic
3	1	CFIN	0.47 μ	Ceramic CAP, X5R, 35V, SM0603	Generic	Generic
4	3	CIN1, CIN2, CIN10	100 μ	Alum. CAP, 25V	UTT1E101MPD	Nichicon
5	7	CIN3, CIN4, CIN5, CIN6, CIN7, CIN8, CIN11	10 μ	Ceramic CAP, X5R, 25V, SM1206	Generic	Generic
6	1	CL1	470p	Ceramic CAP, NPO or COG, SM0805	Generic	Generic
7	2	CL2, CL3	820p	Ceramic CAP, NPO or COG, SM0805	Generic	Generic
8	8	C017, C018, C023, C024, C028, C033, C034, C038	10 μ	Ceramic CAP, X5R, 10V, SM0805	Generic	Generic
9	5	C016, C021, C022, C032, C035	270 μ F	OSCON, 16V, RADIAL 8x8	16SEPC270MX	SANYO
10	3	CS1, CS2, CS3	47n	Ceramic CAP, NPO or COG, SM0603	Generic	Generic
11	1	CVCC	4.7 μ	Ceramic CAP, X5R 10V, SM0805	Generic	Generic
12	2	Cff1	1000p	Ceramic CAP, NPO or COG, SM0603	Generic	Generic
13	1	Cff2	470p	Ceramic CAP, NPO or COG, SM0603	Generic	Generic
14	1	Cff3	330p	Ceramic CAP, NPO or COG, SM0604	Generic	Generic
15	1	L1	4.7 μ H	INDUCTOR, ISAT > 10A	7443320470	Wurth Electronics
16	2	L2, L3	1.0 μ H	INDUCTOR, ISAT > 35A	SER2010-102ML	Coilcraft
17	2	QU1, QL1		Single Channel NFET, 30V	BSC057N03	Infineon
18	6	QU2, QL2, Q2, QU3, QL3, Q3		Single Channel NFET, 30V	BSC0902NS	Infineon
19	3	RB1, RB2, RB3	0	RESISTOR, SM0603	Generic	Generic
20	1	RFIN	22	RESISTOR, SM0603, 10%	Generic	Generic
21	3	RL1, RL2, RL3	1.6	RESISTOR, SM0805, 10%	Generic	Generic
22	3	ROC1, ROC2, ROC3	243k	RESISTOR, SM0603, 1%	Generic	Generic
23	3	RPG1, RPG2, RPG3	100k	RESISTOR, SM0603, 10%	Generic	Generic

Bill of Materials (Continued)

ITEM	QTY	REFERENCE	VALUE	DESCRIPTION	PART #	VENDOR
24	1	RT	88.7k	RESISTOR, SM0603, 1%	Generic	Generic
25	3	Rsen1, Rsen2, Rsen3	2.0k	RESISTOR, SM0603, 1%	Generic	Generic
26	2	R1, R8	30.9k	RESISTOR, SM0603,1%	Generic	Generic
27	2	R2, R11	4.99k	RESISTOR, SM0603,1%	Generic	Generic
28	1	R3	59k	RESISTOR, SM0603,1%	Generic	Generic
29	1	R4	51.1k	RESISTOR, SM0603, 1%	Generic	Generic
30	1	R5	12.1k	RESISTOR, SM0603,1%	Generic	Generic
31	1	R6	15.8k	RESISTOR, SM0603, 1%	Generic	Generic
32	3	R10, R12, R13	10	RESISTOR, SM0603, 10%	Generic	Generic
33	1	U1		Triple PWM Controller, 40L- 5x5 QFN	ISL9444IRZ	Intersil
EVAL BOARD HARDWARE AND RESISTOR JUMPERS						
34	3	JEN1, J14, J15		1x3 Header	Generic	Generic
35	3	JEN2, JEN3, JMODE		2x3 Header	Generic	Generic
36	10	J1, J2, J3, J6, J7, J8, J9, J10, J11, J13		CONN- Big Lug, TERMINAL POST	KPA8CTP	
37	1	J16	BIAS	1x2 Header	Generic	Generic
38	16	TP1, TP2, TP3, TP4, TP5, TP6, TP7, TP8, TP9, TP10, TP11, TP12, TP13, TP14, TP15, TP16		CONN-TURRET, TERMINAL POST, TH	1514-2	KEYSTONE
39	5	JEN1, J14, JEN2, JEN3, JMODE		Connector Jumper	SPC02SYAN	Sullins
OPTIONAL FOOTPRINTS						
40	4	Cp1, Cp2, Cp3, CDLY	DNP	Ceramic CAP, NP0 or COG, SM0603		
41	2	C025, C011, C031	DNP	ELEC. CAP, RADIAL 8x8		
42	2	C013, C029, C014	DNP	CAP, SM1210		
43	4	C012, C015, C026, C027, C036, C037	DNP	ELEC. CAP, SM7343		
44	6	J4, J5, J12, J17, J18, J19	DNP			
45	3	L4, L5, L6	DNP	INDUCTOR		
46	2	Q1, Q5, Q6, Q7	DNP	Single Channel NFET		
47	2	R7, R9	DNP	RESISTOR, SM0603		
COMPONENTS FOR LOAD TRANSIENT TEST CIRCUITS						
48	3	Q8, Q9, Q10	DNP	N-Channel MOSFET, TO252		
49	1	R17, R19, R21	DNP, 0.01	RESISTOR, SM2512		
50	3	R18, R20, R22	DNP, 10k	RESISTOR, SM0603		

ISL9444EVAL3Z PCB Layout

FIGURE 19. TOP SILKSCREEN

ISL9444EVAL3Z PCB Layout (Continued)

FIGURE 20. TOP LAYER

ISL9444EVAL3Z PCB Layout (Continued)

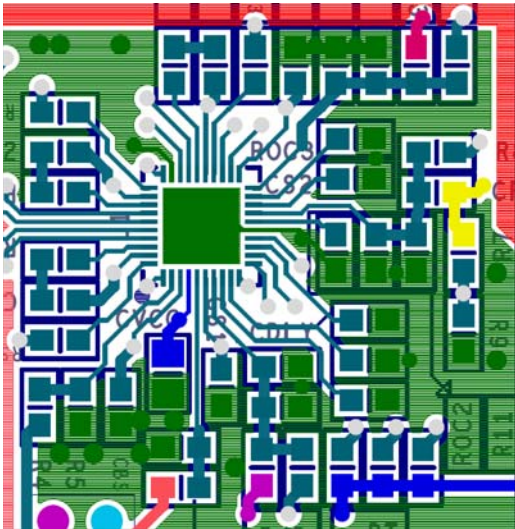
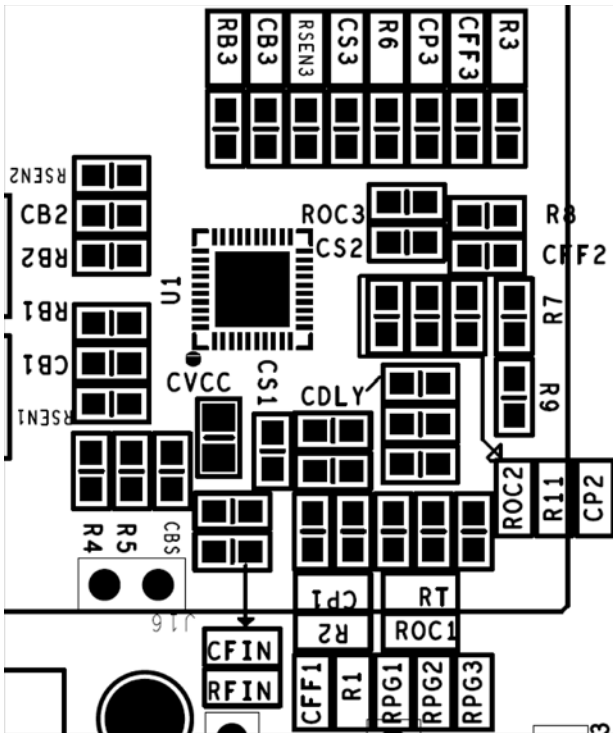

FIGURE 21. TOP LAYER ZOOM IN

ISL9444EVAL3Z PCB Layout (Continued)

FIGURE 22. SECOND LAYER

ISL9444EVAL3Z PCB Layout (Continued)

FIGURE 23. BOTTOM SILKSCREEN

ISL9444EVAL3Z PCB Layout (Continued)

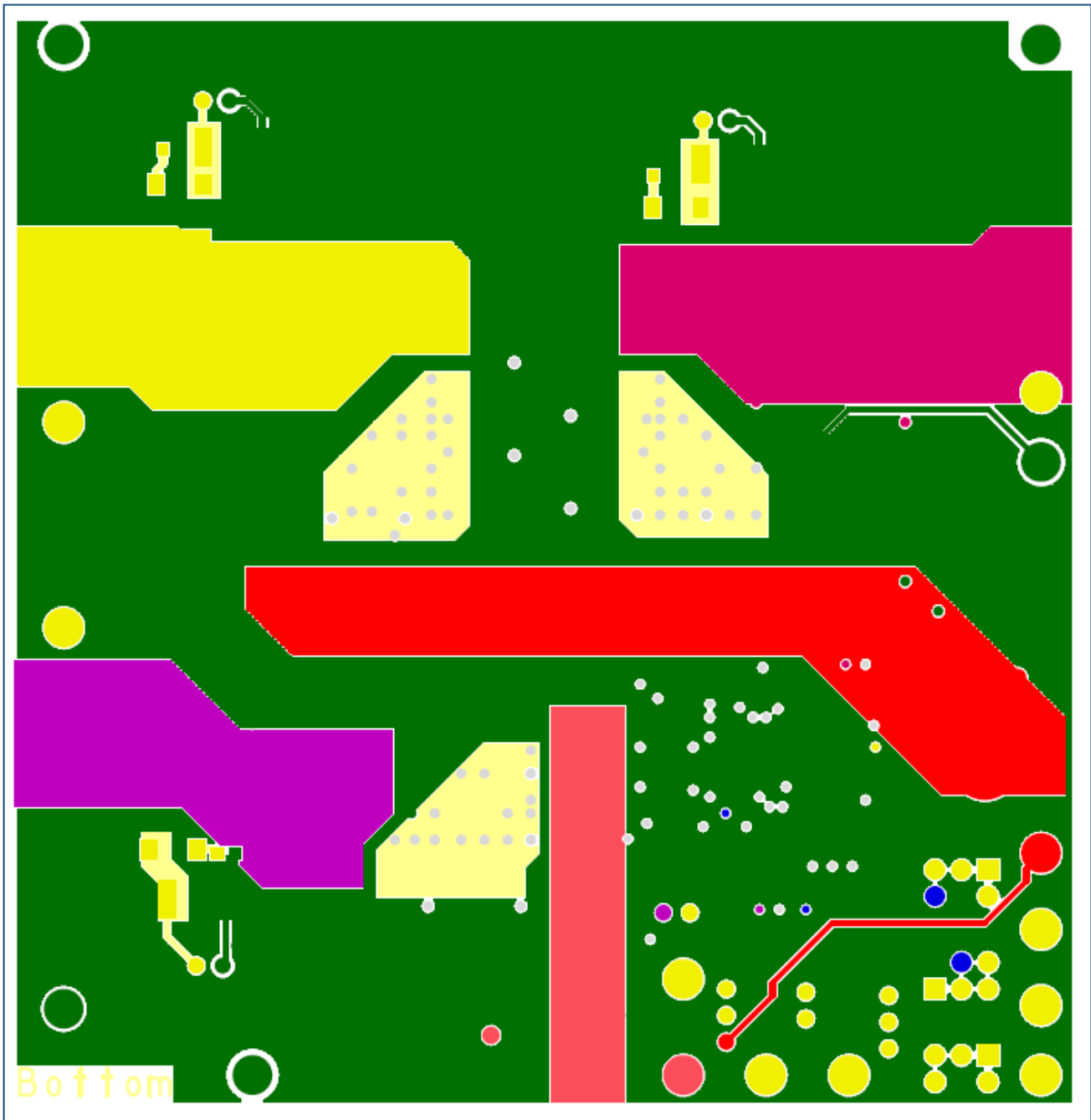

FIGURE 24.

ISL9444EVAL3Z PCB Layout (Continued)

FIGURE 25. BOTTOM SILKSCREEN

Notice

1. Descriptions of circuits, software and other related information in this document are provided only to illustrate the operation of semiconductor products and application examples. You are fully responsible for the incorporation or any other use of the circuits, software, and information in the design of your product or system. Renesas Electronics disclaims any and all liability for any losses and damages incurred by you or third parties arising from the use of these circuits, software, or information.
2. Renesas Electronics hereby expressly disclaims any warranties against and liability for infringement or any other claims involving patents, copyrights, or other intellectual property rights of third parties, by or arising from the use of Renesas Electronics products or technical information described in this document, including but not limited to, the product data, drawings, charts, programs, algorithms, and application examples.
3. No license, express, implied or otherwise, is granted hereby under any patents, copyrights or other intellectual property rights of Renesas Electronics or others.
4. You shall not alter, modify, copy, or reverse engineer any Renesas Electronics product, whether in whole or in part. Renesas Electronics disclaims any and all liability for any losses or damages incurred by you or third parties arising from such alteration, modification, copying or reverse engineering.
5. Renesas Electronics products are classified according to the following two quality grades: "Standard" and "High Quality". The intended applications for each Renesas Electronics product depends on the product's quality grade, as indicated below.
"Standard": Computers; office equipment; communications equipment; test and measurement equipment; audio and visual equipment; home electronic appliances; machine tools; personal electronic equipment; industrial robots; etc.
"High Quality": Transportation equipment (automobiles, trains, ships, etc.); traffic control (traffic lights); large-scale communication equipment; key financial terminal systems; safety control equipment; etc.
Unless expressly designated as a high reliability product or a product for harsh environments in a Renesas Electronics data sheet or other Renesas Electronics document, Renesas Electronics products are not intended or authorized for use in products or systems that may pose a direct threat to human life or bodily injury (artificial life support devices or systems; surgical implantations; etc.), or may cause serious property damage (space system; undersea repeaters; nuclear power control systems; aircraft control systems; key plant systems; military equipment; etc.). Renesas Electronics disclaims any and all liability for any damages or losses incurred by you or any third parties arising from the use of any Renesas Electronics product that is inconsistent with any Renesas Electronics data sheet, user's manual or other Renesas Electronics document.
6. When using Renesas Electronics products, refer to the latest product information (data sheets, user's manuals, application notes, "General Notes for Handling and Using Semiconductor Devices" in the reliability handbook, etc.), and ensure that usage conditions are within the ranges specified by Renesas Electronics with respect to maximum ratings, operating power supply voltage range, heat dissipation characteristics, installation, etc. Renesas Electronics disclaims any and all liability for any malfunctions, failure or accident arising out of the use of Renesas Electronics products outside of such specified ranges.
7. Although Renesas Electronics endeavors to improve the quality and reliability of Renesas Electronics products, semiconductor products have specific characteristics, such as the occurrence of failure at a certain rate and malfunctions under certain use conditions. Unless designated as a high reliability product or a product for harsh environments in a Renesas Electronics data sheet or other Renesas Electronics document, Renesas Electronics products are not subject to radiation resistance design. You are responsible for implementing safety measures to guard against the possibility of bodily injury, injury or damage caused by fire, and/or danger to the public in the event of a failure or malfunction of Renesas Electronics products, such as safety design for hardware and software, including but not limited to redundancy, fire control and malfunction prevention, appropriate treatment for aging degradation or any other appropriate measures. Because the evaluation of microcomputer software alone is very difficult and impractical, you are responsible for evaluating the safety of the final products or systems manufactured by you.
8. Please contact a Renesas Electronics sales office for details as to environmental matters such as the environmental compatibility of each Renesas Electronics product. You are responsible for carefully and sufficiently investigating applicable laws and regulations that regulate the inclusion or use of controlled substances, including without limitation, the EU RoHS Directive, and using Renesas Electronics products in compliance with all these applicable laws and regulations. Renesas Electronics disclaims any and all liability for damages or losses occurring as a result of your noncompliance with applicable laws and regulations.
9. Renesas Electronics products and technologies shall not be used for or incorporated into any products or systems whose manufacture, use, or sale is prohibited under any applicable domestic or foreign laws or regulations. You shall comply with any applicable export control laws and regulations promulgated and administered by the governments of any countries asserting jurisdiction over the parties or transactions.
10. It is the responsibility of the buyer or distributor of Renesas Electronics products, or any other party who distributes, disposes of, or otherwise sells or transfers the product to a third party, to notify such third party in advance of the contents and conditions set forth in this document.
11. This document shall not be reprinted, reproduced or duplicated in any form, in whole or in part, without prior written consent of Renesas Electronics.
12. Please contact a Renesas Electronics sales office if you have any questions regarding the information contained in this document or Renesas Electronics products.
(Note 1) "Renesas Electronics" as used in this document means Renesas Electronics Corporation and also includes its directly or indirectly controlled subsidiaries.
(Note 2) "Renesas Electronics product(s)" means any product developed or manufactured by or for Renesas Electronics.

(Rev.4.0-1 November 2017)



SALES OFFICES

Renesas Electronics Corporation

<http://www.renesas.com>

Refer to "<http://www.renesas.com/>" for the latest and detailed information.

Renesas Electronics America Inc.
1001 Murphy Ranch Road, Milpitas, CA 95035, U.S.A.
Tel: +1-408-432-8888, Fax: +1-408-434-5351

Renesas Electronics Canada Limited
9251 Yonge Street, Suite 8309 Richmond Hill, Ontario Canada L4C 9T3
Tel: +1-905-237-2004

Renesas Electronics Europe Limited
Dukes Meadow, Millboard Road, Bourne End, Buckinghamshire, SL8 5FH, U.K.
Tel: +44-1628-651-700, Fax: +44-1628-651-804

Renesas Electronics Europe GmbH
Arcadiastrasse 10, 40472 Düsseldorf, Germany
Tel: +49-211-6503-0, Fax: +49-211-6503-1327

Renesas Electronics (China) Co., Ltd.
Room 1709 Quantum Plaza, No.27 ZhichunLu, Haidian District, Beijing, 100191 P. R. China
Tel: +86-10-8235-1155, Fax: +86-10-8235-7679

Renesas Electronics (Shanghai) Co., Ltd.
Unit 301, Tower A, Central Towers, 555 Langao Road, Putuo District, Shanghai, 200333 P. R. China
Tel: +86-21-2226-0888, Fax: +86-21-2226-0999

Renesas Electronics Hong Kong Limited
Unit 1601-1611, 16/F., Tower 2, Grand Century Place, 193 Prince Edward Road West, Mongkok, Kowloon, Hong Kong
Tel: +852-2265-6688, Fax: +852-2886-9022

Renesas Electronics Taiwan Co., Ltd.
13F, No. 363, Fu Shing North Road, Taipei 10543, Taiwan
Tel: +886-2-8175-9600, Fax: +886-2-8175-9670

Renesas Electronics Singapore Pte. Ltd.
80 Bendemeer Road, Unit #06-02 Hyflux Innovation Centre, Singapore 339949
Tel: +65-6213-0200, Fax: +65-6213-0300

Renesas Electronics Malaysia Sdn.Bhd.
Unit 1207, Block B, Menara Amcorp, Amcorp Trade Centre, No. 18, Jln Persiaran Barat, 46050 Petaling Jaya, Selangor Darul Ehsan, Malaysia
Tel: +60-3-7955-9390, Fax: +60-3-7955-9510

Renesas Electronics India Pvt. Ltd.
No.777C, 100 Feet Road, HAL 2nd Stage, Indiranagar, Bangalore 560 038, India
Tel: +91-80-67208700, Fax: +91-80-67208777

Renesas Electronics Korea Co., Ltd.
17F, KAMCO Yangjae Tower, 262, Gangnam-daero, Gangnam-gu, Seoul, 06265 Korea
Tel: +82-2-558-3737, Fax: +82-2-558-5338