

RTKA489800DE0000BU

User's Manual: Evaluation Board

Battery and Optical

All information contained in these materials, including products and product specifications, represents information on the product at the time of publication and is subject to change by Renesas Electronics Corp. without notice. Please review the latest information published by Renesas Electronics Corp. through various means, including the Renesas Electronics Corp. website (<http://www.renesas.com>).

RTKA489800DE0000BU

Evaluation Board

The [RAA489800](#) is a bidirectional, buck-boost voltage regulator that provides buck-boost voltage regulation and protection features. The advanced Renesas R3™ Technology provides high light-load efficiency, fast transient response, and seamless DCM/CCM transitions.

The RTKA489800DE0000BU takes input power from a wide range of DC power sources up to 23V (such as conventional AC/DC adapters (ADP), USB PD ports, travel ADP) and safely converts it to a regulated voltage up to 21V. The RAA489800 can also convert a wide range DC power source connected at its output (system side) to a regulated voltage to its input (ADP side). This bidirectional buck-boost regulation feature makes the RAA489800 application versatile. In addition to 4-switch buck-boost configuration, it can also support the 2-switch Buck mode operation.

The RTKA489800DE0000BU includes various system operation functions such as the Forward mode enable pin, Reverse mode enable pin, programmable soft-start time, and adjustable forward and reverse VOUT. It also has forward and reverse power-good indicators. The protection functionalities include OCP, OVP, UVP, and OTP.

The RTKA489800DE0000BU has serial communication through SMBus/I²C that allows programming of many critical parameters to deliver a customized solution. These programming parameters include but are not limited to output current limit, input current limit, and output voltage setting.

Key Features

- Bidirectional buck, boost, and buck-boost operation
- Configurable for 4-switch buck-boost or 2-switch buck operation
- Input voltage range: 3.8V to 23V (no dead zone)
- Output voltage: up to 21V
- Up to 1MHz switching frequency
- Pin programmable soft-start time
- LDO output for VDD and VDDP
- System FAULT status ALERT function
- Input/output internal discharge function
- Active switching for negative voltage transitions
- Pass-Through mode in both directions
- Forward and Reverse mode enable pins
- OCP, OVP, UVP, and OTP protection
- Absolute overvoltage protection
- SMBus and auto-increment I²C compatible

Specifications

The RTKA489800DE0000BU is configured and optimized for the following operating conditions:

- V_{IN} = 3.8V to 24V (no dead zone)
- V_{OUT} = 2.4V to 20V
- f_{SW} = 1MHz maximum

Ordering Information

Part Number	Description
RTKA489800DE0000BU	RAA489800 evaluation board

Related Literature

For a full list of related documents, visit our website:

- [RAA489800](#) device page

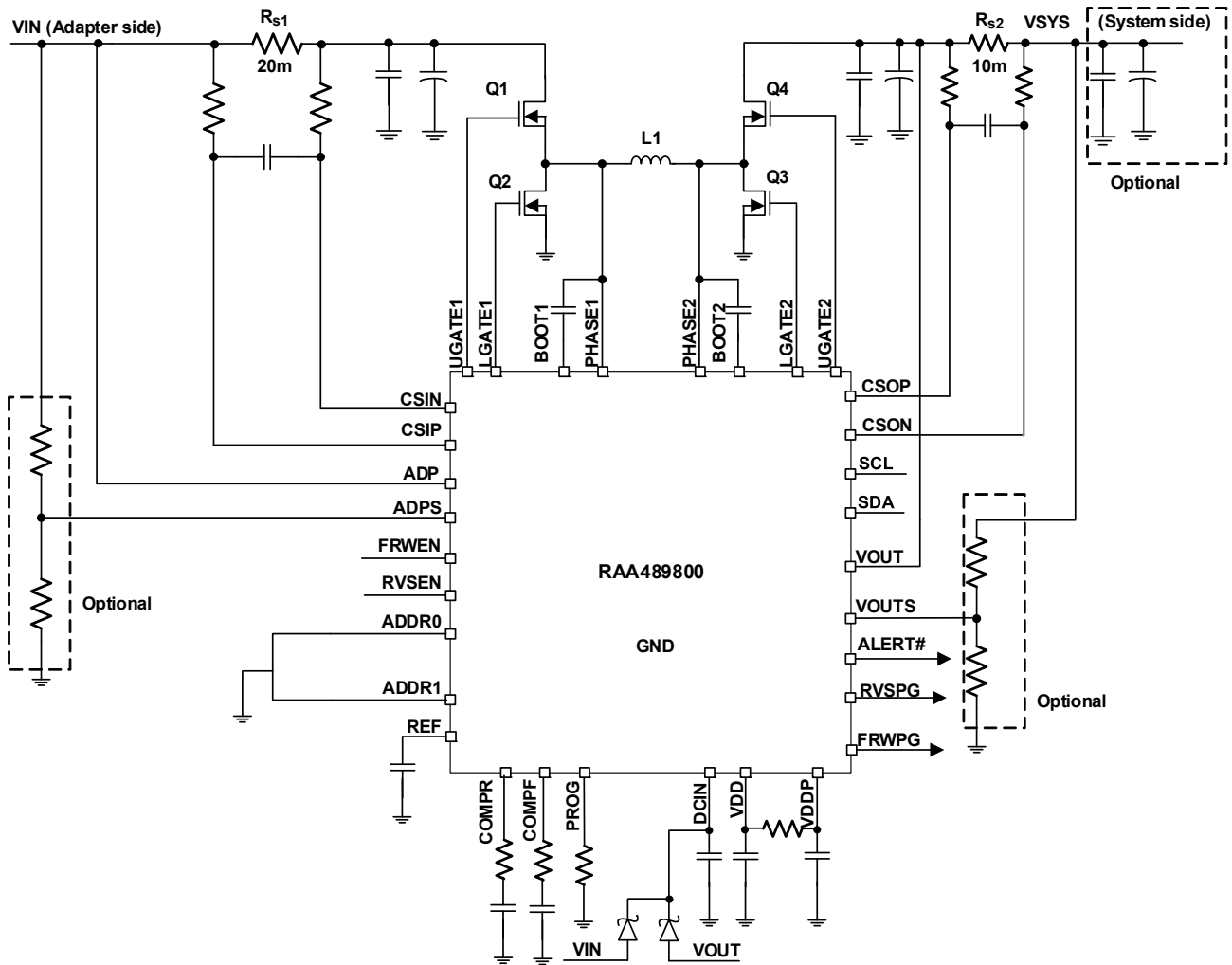

Figure 1. Block Diagram

1. Functional Description

The RTKA489800DE0000BU provides all circuits required to evaluate the RAA489800 features. A majority of the features are available on this evaluation board, including: adjustable output voltage in Forward mode and Reverse mode; programmable REF voltage; fast VDAC changing at no load condition; and Buck, Boost, and Buck-Boost modes.

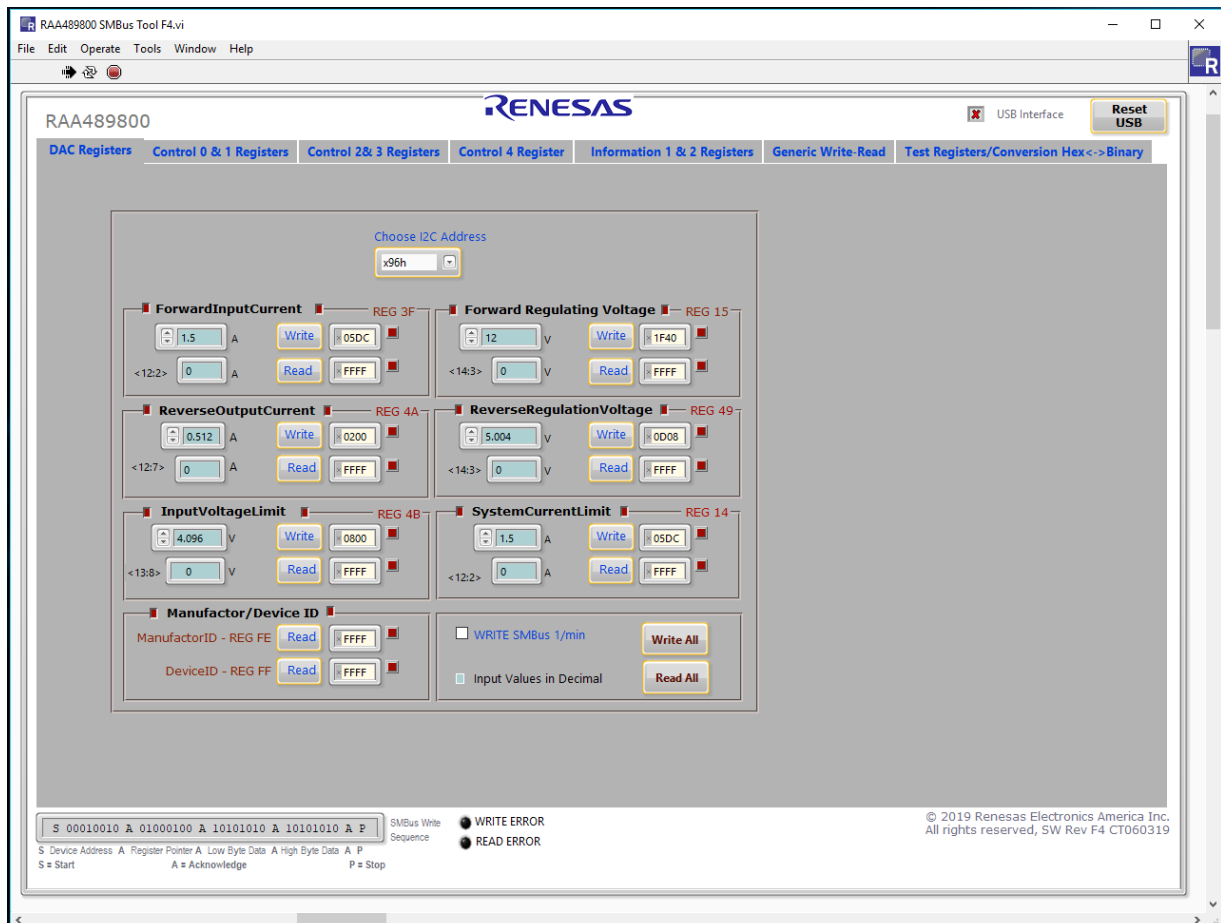

Figure 2. GUI Snapshot

1.1 Quick Start Guide

The RTKA489800DE0000BU can provide bidirectional output voltage up to 21V. The forward output voltage default values and forward input current limit values can be configured with a standard 1% 0603 resistor (R23) from the PROG pin to GND. The PROG Pin Programming Options table in the [RAA489800](#) datasheet shows the programming options. After the default forward output voltage is set, this value can also be changed through the SMBus control register, ForwardRegulatingVoltage (0X15H). The reverse output voltage value can be set through the SMBus control register, ReverseRegulatingVoltage (0X49H). The protection values, including forward input current limit, reverse output current limit, forward input voltage limit, and system side current limit can be programmed through the SMBus control registers, 0X3FH, 0X4AH, 0X4BH, and 0X14H, respectively.

The RAA489800 also provides a programmable SMBus address to support multiple SMBus chips sharing common SMBus, through ADDR0 and ADDR1 pins. Details for programmable addresses are shown in the Address Table in the [RAA489800](#) datasheet.

Forward Power-Good (FWRPG), Reverse Power-Good (RVSPG), and ALERT# each have an ADP side and system side status indicated by LEDs. See [Figure 3 on page 5](#) for the three LED positions. [Figure 3](#) shows the top view of the evaluation board and highlights the key testing points and connection terminals.

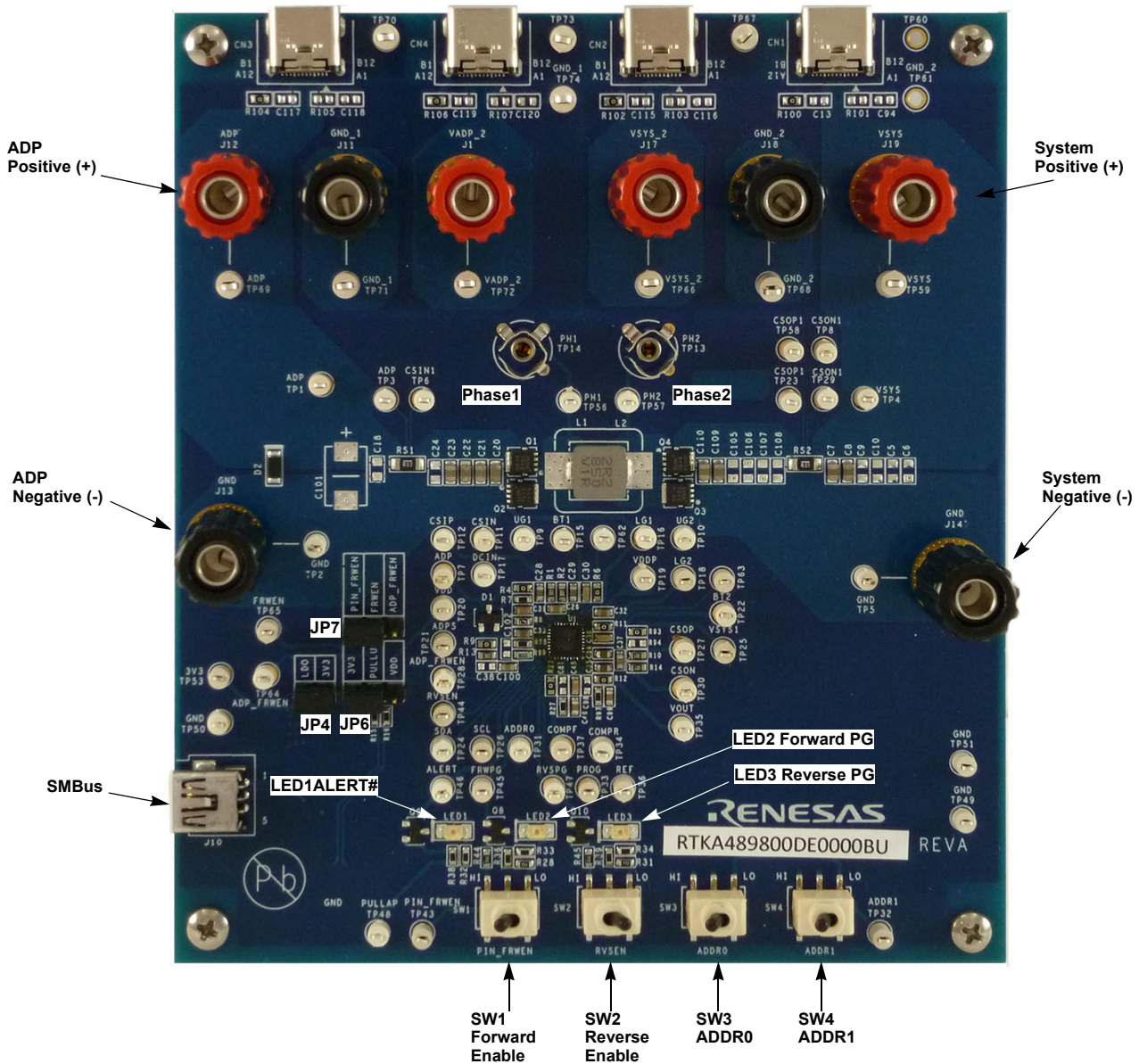

Figure 3. Evaluation Board Connection Guideline

1.2 Required Equipment

The following equipment is needed to operate the board:

- 0V to 25V power supply with at least 6A source current capability
- Electronic load capable of sinking current up to 6A
- Digital Multimeters (DMMs)
- 100MHz quad-trace oscilloscope

Use the following steps to evaluate some key functions including Enable Forward mode and Enable Reverse mode. For other features, or more information about the RAA489800 device, see [RAA489800](#) datasheet.

1.2.1 Enabling Forward Mode in Buck Mode

1. Set the 20V supply to 12V and, with SW1 in the low position, connect the (+) source to the ADP positive terminal and the (-) source to the ADP negative terminal.
2. Ensure that jumpers JP4, JP6, and JP7 are shorted. SW1 and SW2 should be in the low position.
3. Connect the USB cable to the USB port for SMBus. LED1, LED2, and LED3 light up.
4. Open the RAA489800 GUI. Ensure that SW3 and SW4 are in the high position, and that the RAA489800 address is 0x96H.
5. Turn on the power supply. LED2 and LED3 extinguish. **Note:** A green check mark indicates that the GUI is ready to communicate with the evaluation board. A red X indicates that the GUI is not ready to communicate with the evaluation board. Click the USB reset button until the green check mark shows in the USB interface. If not, check the USB connection, VDD, and SMBus address settings.
6. Input 5V to forward regulating voltage register (0x15H), turn SW1 (FRWEN pin) to high to enable the forward output, monitor VOUT and the REF pin waveform. When VREF reaches 5V, LED2 (FWRPG) lights up.
7. Measure VOUT using the DMM across the system positive (+) and system negative (-). VOUT should read 5V. The current meter on the supply should read <100mA. Monitor PH1 to observe Buck mode operation.

Note: If a load is added on the system side, ensure that the current limit values in the system current limit and forward input current limit registers are not affected. The soft-start time can be set by changing the capacitor values connected to the REF pin, see the [RAA489800](#) datasheet.

1.2.2 Enabling Reverse Mode in Buck Mode

1. Set the 20V supply to 12V and, with SW1 in the low position, connect the (+) source to the system positive terminal and the (-) source to the system negative terminal.
2. Ensure that jumpers JP4, JP6, and JP7 are shorted. SW1 and SW2 should be in the low position.
3. Connect the USB cable to the USB port for SMBus. LED1, LED2, and LED3 light up.
4. Open RAA489800 GUI. Ensure that SW3 and SW4 are in the high position, and that the RAA489800 address is 0x96H.
5. Turn on the power supply. **Note:** A green check mark indicates that the GUI is ready to communicate with the evaluation board. A red X indicates that the GUI is not ready to communicate with the evaluation board. Click the USB reset button until the green check mark shows in the USB interface. If not, check the USB connection, VDD, and SMBus address settings.
6. Input 5V to reverse regulating voltage register (0x49H), turn SW2 (RVSEN pin) to high to enable reverse output, monitor VOUT and the REF pin waveform. When VREF reaches 5V, LED3 (RVSPG) lights up.
7. Measure VOUT using the DMM across the ADP positive (+) and ADP negative (-). VOUT should read 5V. The current meter on the supply should read <100mA. Monitor PH2 to observe Buck mode operation.

Note: If a load is added on the ADP side, ensure that the current limit value in the reverse output current register is not affected. The soft-start time can be set by changing capacitor values connected to the REF pin. See the [RAA489800](#) datasheet.

2. PCB Layout Guidelines

2.1 RTKA489800DE0000BU Evaluation Board

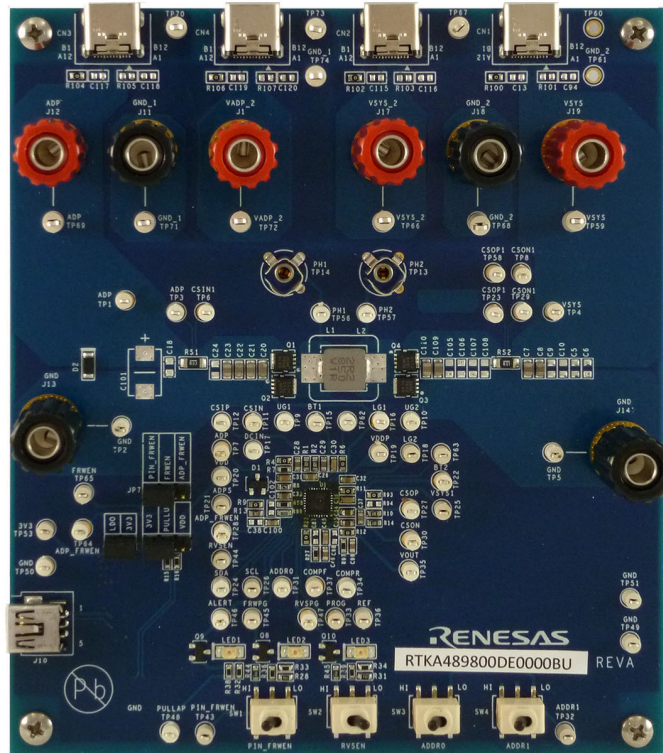

Figure 4. Figure 4. Evaluation Board Top

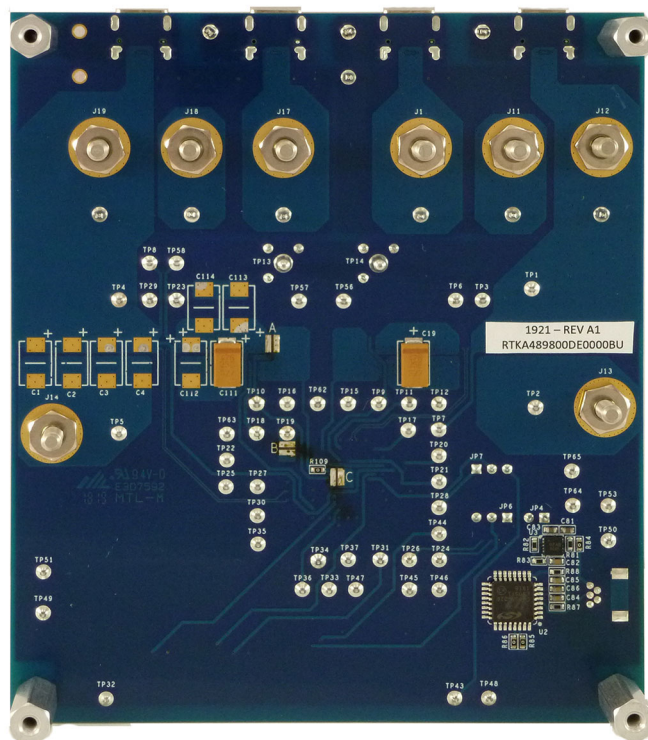
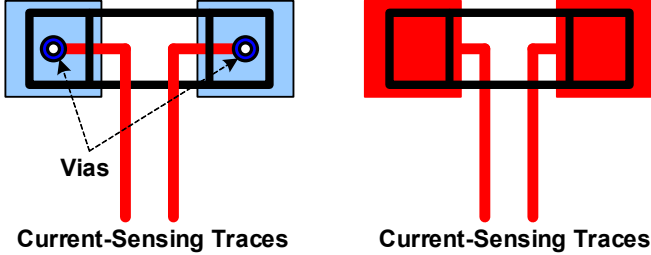
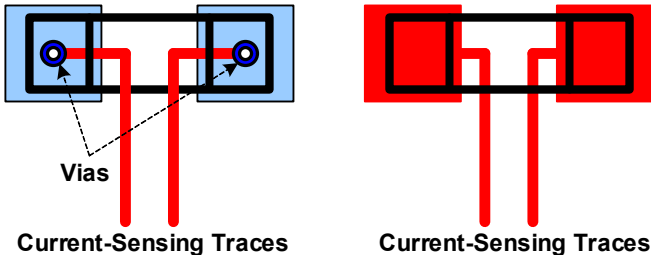

Figure 5. Figure 5. Evaluation Board Bottom

2.2 Layout Guidelines

Pin Number	Pin Name	Layout Guidelines
Bottom PAD	GND	Connect this ground pad to the ground plane through a low impedance path. Renesas recommends using at least five vias to connect to the ground planes in the PCB to ensure sufficient thermal dissipation directly under the IC.
1	CSOP	<p>Run two dedicated traces with sufficient width in parallel (close to each other to minimize the loop area) from the two terminals of the battery current-sensing resistor to the IC. Place the differential mode and common-mode RC filter components in the general proximity to the controller.</p> <p>Route the current-sensing traces through vias to connect the center of the pads or route the traces into the pads from the inside of the current-sensing resistor. The following drawings show the two preferred ways of routing current-sensing traces.</p> <div style="text-align: center;">  </div>
2	CSOP	
3	VOUTS	Signal pin that provides feedback for the forward system bus voltage. Run a dedicated trace from system bus to the pin and do not route near the switching traces. Do not share the same trace with the signal routing to the DCIN pin OR diodes.
4	BOOT2	Switching pin. Place the bootstrap capacitor in the general proximity to the controller. Use decent wide trace. Avoid any sensitive analog signal trace from crossing over or getting too close.
5	UGATE2	<p>Run these two traces in parallel fashion with sufficient width. Avoid any sensitive analog signal trace from crossing over or getting too close. Recommend routing the PHASE2 trace to high-side MOSFET source pin instead of general copper.</p> <p>Place the IC close to the switching MOSFETs gate terminals and keep the gate drive signal traces short for a clean MOSFET drive. The IC can be placed on the opposite side of the switching MOSFETs.</p> <p>Place the output capacitors as close as possible to the switching high-side MOSFET drain and the low-side MOSFET source; use shortest PCB trace connection. Place these capacitors on the same PCB layer with the MOSFETs instead of on different layers and using vias to make the connection.</p> <p>Place the inductor terminal to the switching high-side MOSFET drain and low-side MOSFET source terminal as close as possible. Minimize this phase node area to lower the electrical and magnetic field radiation, but make this phase node area sufficient to carry the current. Place the inductor and the switching MOSFETs on the same layer of the PCB.</p>
6	PHASE2	
7	LGATE2	Switching pin. Run the LGATE2 trace in parallel with the UGATE2 and PHASE2 traces on the same PCB layer. Use sufficient width. Avoid any sensitive analog signal trace from crossing over or getting too close.
8	VDDP	Place the decoupling capacitor in general proximity to the controller. Run the trace connecting to VDD pin with sufficient width.
9	LGATE1	Switching pin. Run the LGATE1 trace in parallel with the UGATE1 and PHASE1 traces on the same PCB layer. Use sufficient width. Avoid any sensitive analog signal trace from crossing over or getting too close.
10	PHASE1	<p>Run these two traces in parallel fashion with sufficient width. Avoid any sensitive analog signal trace from crossing over or getting too close. Renesas recommends routing the PHASE1 trace to high-side MOSFET source pin instead of general copper.</p> <p>Place the IC close to the switching MOSFETs gate terminals and keep the gate drive signal traces short for a clean MOSFET drive. The IC can be placed on the opposite side of the switching MOSFETs.</p> <p>Place the input capacitors as close as possible to the switching high-side MOSFET drain and the low-side MOSFET source; use shortest PCB trace connection. Place these capacitors on the same PCB layer with the MOSFETs instead of on different layers and using vias to make the connection.</p> <p>Place the inductor terminal to the switching high-side MOSFET drain and low-side MOSFET source terminal as close as possible. Minimize this phase node area to lower the electrical and magnetic field radiation but make this phase node area large enough to carry the current. Place the inductor and the switching MOSFETs on the same layer of the PCB.</p>
11	UGATE1	
12	BOOT1	Switching pin. Place the bootstrap capacitor in the general proximity to the controller. Use decent wide trace. Avoid any sensitive analog signal trace from crossing over or getting too close.

Pin Number	Pin Name	Layout Guidelines
13	ADPS	Run this trace with sufficient width parallel to the ADP pin trace.
14	CSIN	Run two dedicated traces with sufficient width in parallel (close to each other to minimize the loop area) from the two terminals of the adapter current-sensing resistor to the IC. Place the Differential mode and common-mode RC filter components in the general proximity to the controller.
15	CSIP	<p>Route the current-sensing traces through vias to connect the center of the pads or route the traces into the pads from the inside of the current-sensing resistor. The following drawings show the two preferred ways of routing current-sensing traces.</p> 
16	ADP	Run this trace with sufficient width parallel to the ADPS pin trace.
17	DCIN	Place the OR diodes and the RC filter in the general proximity to the controller. Run the VADP trace and VSYS trace to the OR diodes with sufficient width.
18	VDD	Place the RC filter connecting with VDDP pin in the general proximity to the controller. Run the trace connecting to VDDP pin with sufficient width.
19	FRWEN	No special consideration.
20	RVSEN	
21	SDA	Digital pins. No special consideration. Run the SDA and SCL traces in parallel.
22	SCL	
23	ALERT#	Digital pin, open-drain output. No special consideration.
24	FRWPG	
25	ADDR0	No special consideration.
26	RVSPG	Digital pin, open-drain output. No special consideration.
27	PROG	Signal pin. Place the PROG programming resistor in the general proximity to the controller
28	COMPF	Place the compensation components in the general proximity to the controller. Avoid any switching signal from crossing over or getting too close.
29	REF	Place the reference capacitor in the general proximity to the controller.
30	COMPR	Place the compensation components in the general proximity to the controller. Avoid any switching signal from crossing over or getting too close.
31	VOUT	Run a dedicated trace from system bus to the pin and do not route near the switching traces.
32	ADDR1	No special consideration.

2.3 RTKA489800DE0000BU Circuit Schematic

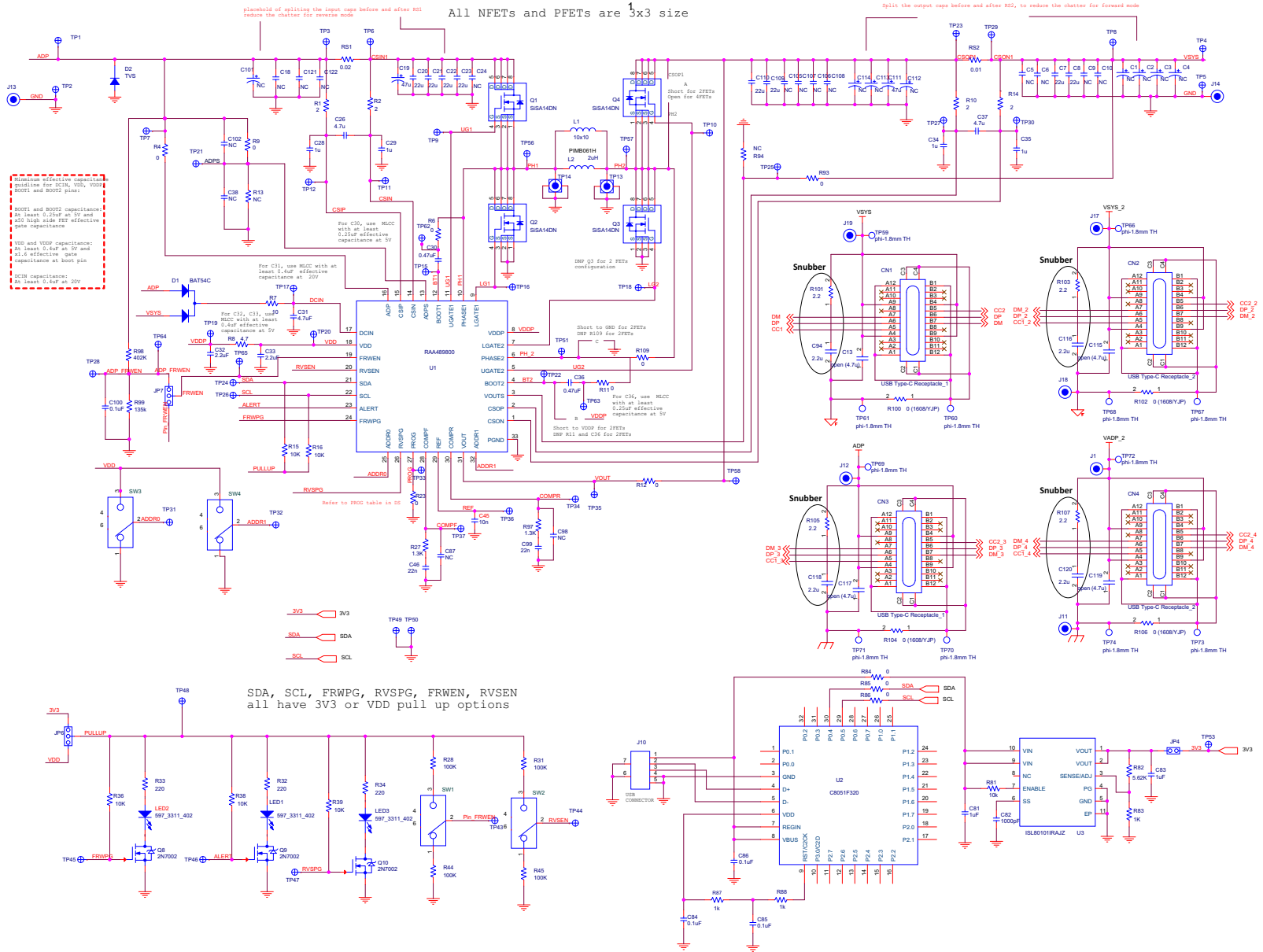

Figure 6. Evaluation Board Schematic

2.4 Bill of Materials

Qty	Reference Designator	Description	Manufacturer	Manufacturer Part Number
1	See Label Rename Board	PWB-PCB, RTKA489800DE0000BU, REVA, ROHS	Imagineering Inc	RTKA489800DE0000BURAPCB
1	C82	CAP, SMD, 0603, 1000pF, 16V, 10%, X7R, ROHS	AVX	0603YC102KAT2A
1	C45	CAP, SMD, 0603, 10000pF, 16V, 10%, X7R, ROHS	AVX	0603YC103KAT2A
4	C84, C85, C86, C100	CAP, SMD, 0603, 0.1μF, 25V, 10%, X7R, ROHS	MURATA	GCJ188R71E104KA12D
1	C31	CAP, SMD, 0603, 4.7μF, 35V, 10%, X5R, ROHS	MURATA	GRM188R6YA475KE15D
2	C32, C33	CAP, SMD, 0603, 2.2μF, 10V, 10%, X5R, ROHS	MURATA	GRM188R71A225KE15D
6	C28, C29, C34, C35, C81, C83	CAP, SMD, 0603, 1μF, 25V, 10%, X5R, ROHS	MURATA	GRM188R61E105KAADD
2	C46, C99	CAP, SMD, 0603, 0.022μF, 25V, 10%, X7R, ROHS	MURATA	GRM188R71E223KA01J
2	C30, C36	CAP, SMD, 0603, 0.47μF, 25V, 10%, X7R, ROHS	MURATA	GRM188R71E474KA12D
2	C26, C37	CAP, SMD, 0603, 4.7μF, 10V, 10%, X5R, ROHS	MURATA	GRM185R61A475KE11D
0	C87, C98	CAP, SMD, 0603, DNP-PLACE HOLDER, ROHS		
8	C20-C23, C109-C110, C7-C8	CAP, SMD, 0805, 22μF, 25V, 20%, X5R, ROHS	MURATA	GRM21BR61E226ME44L
2	C19, C111	CAP-TANT, SMD, 7.3x4.3x3, 47μF, 25V, 20%, 700mΩ, ROHS	KEMET	T491D476M025AT
4	CN1, CN2, CN3, CN4	USB Type-C Receptacle	JAE Electronics	DX07S024JJ2
1	L1	PWR CHOKE COIL, SMD, 6.95x6.6, 2.2μH, 10A, 20%, ROHS	CYNTEC CO., LTD.	PIMB063T-2R2MS-01
4	J1, J12, J17, J19	CONN-GEN, BIND.POST, INSUL-RED, THMBNUT-GND	JOHNSON COMPONENTS	111-0702-001
4	J11, J13, J14, J18	CONN-GEN, BIND.POST, INSUL-BLK, THMBNUT-GND	JOHNSON COMPONENTS	111-0703-001
2	TP13, TP14	CONN-SCOPE PROBE TEST PT, COMPACT, PCB MNT, ROHS	TEKTRONIX	131-4353-00
61	TP1-TP12, TP15-TP37, TP43-TP51, TP53, TP57-TP58, TP59, TP62-TP65. TP66-TP74	CONN-MINI TEST POINT, VERTICAL, WHITE, ROHS	KEYSTONE	5002
0		TH_1.8mm_phi		
1	J10	CONN-USB MINI-B RECEPTACLE, TH, 5CIRCUIT, R/A, ROHS	MOLEX	548190519
2	JP6, JP7	CONN-HEADER, 1x3, BREAKAWY 1x36, 2.54mm, ROHS	BERG/FCI	68000-236HLF
1	JP4	CONN-HEADER, 1x2, RETENTIVE, 2.54mm, 0.230x0.120, ROHS	BERG/FCI	69190-202HLF
3	JP4-Pins 1-2, JP6-Pins 1-2, JP7-Pins 2-3	CONN-JUMPER, SHORTING, 2PIN, BLACK, GOLD, ROHS	SULLINS	SPC02SYAN
1	D1	DIODE-RECTIFIER, SMD, SOT23, 30V, 200mA, DUAL DIODE, ROHS	VISHAY	BAT54C-7-F
1	D2	225W SURFACE MOUNT TRANSIENT VOLTAGE SUPPRESSOR	DIODES, INC.	DFLT30A-7

Qty	Reference Designator	Description	Manufacturer	Manufacturer Part Number
3	LED1, LED2, LED3	LED, SMD, 1206, GREEN, 75mW, 3mcd, 567nm, ROHS	DIALIGHT	5973311407NF
1	U2	IC-USB MICROCONTROLLER, 32P, LQFP, PROGRAMMED, ROHS	SILICON LABS	C8051F320-GQ
1	U3	IC-ADJ.V, 1A LDO REGULATOR, 10P, DFN, 3x3, ROHS	Renesas	ISL80101IRAJZ
1	U1	C-NOTEBOOK BATTERY CHARGER, 32P, QFN, 4x4, ROHS	RENESAS	RAA489800ARGNP#AA0
3	Q8, Q9, Q10	TRANSISTOR, N-CHANNEL, 3LD, SOT-23, 60V, 115mA, ROHS	DIODES, INC.	2N7002-7-F
4	Q1, Q2, Q3, Q4	TRANSISTOR-MOS, N-CHANNEL, 8P, PWRPAK, 30V, 20A, ROHS	VISHAY	SISA14DN-T1-GE3
1	R99	RES, SMD, 0603, 135k, 1/10W, 0.1%, ROHS	YAGEO	RT0603BRD07135KL
1	R7	RES, SMD, 0603, 10Ω, 1/10W, 1%, TF, ROHS	PANASONIC	ERJ-3EKF10R0V
4	R1, R2, R10, R14	RES, SMD, 0603, 2Ω, 1/10W, 1%, TF, ROHS	YAGEO	RC0603FR-072RL
1	R8	RES, SMD, 0603, 4.7Ω, 1/10W, 1%, TF, ROHS	PANASONIC	ERJ-3RQF4R7V
15	R4, R6, R9, R11, R12, R23, R84, R85, R86, R93, R100, R102, R104, R106, R109	RES, SMD, 0603, 0Ω, 1/10W, TF, ROHS	PANASONIC	ERJ-3GEY0R00V
3	R83, R87, R88	RES, SMD, 0603, 1k, 1/10W, 1%, TF, ROHS	PANASONIC	ERJ-3EKF1001V
6	R15, R16, R36, R38, R39, R81	RES, SMD, 0603, 10k, 1/10W, 1%, TF, ROHS	PANASONIC	ERJ-3EKF1002V
4	R28, R31, R44, R45	RES, SMD, 0603, 100k, 1/10W, 1%, TF, ROHS	PANASONIC	ERJ-3EKF1003V
1	R13	RES, SMD, 0603, 1M, 1/10W, 1%, TF, ROHS	PANASONIC	ERJ-3EKF1004V
3	R32, R33, R34	RES, SMD, 0603, 220Ω, 1/10W, 1%, TF, ROHS	PANASONIC	ERJ-3EKF2200V
1	R98	RES, SMD, 0603, 402k, 1/16W, 1%, TF, ROHS	PANASONIC	ERJ-3EKF4023V
1	R82	RES, SMD, 0603, 5.62k, 1/10W, 1%, TF, ROHS	PANASONIC	ERJ-3EKF5621V
2	R27, R97	RES, SMD, 0603, 1.3k, 1/10W, 1%, TF, ROHS	PANASONIC	ERJ-3EKF1301V
1	RS2	RES-CURR.SENSE, SMD, 1206, 0.01Ω, 1W, 1%, 75ppm, ROHS	VISHAY/DALE	WSLP1206R0100FEA
1	RS1	RES-CURR.SENSE, SMD, 1206, 0.02Ω, 1W, 1%, 75ppm, ROHS	VISHAY/DALE	WSLP1206R0200FEA
4	SW1, SW2, SW3, SW4	SWITCH-TOGGLE, SMD, 6PIN, SPDT, 2POS, ON-NONE-ON, ROHS	ITT INDUSTRIES/C&K DIVISION	GT11MSCBE
4	Four corners	SCREW, 4-40x1/4in, PHILLIPS, PANHEAD, STAINLESS, ROHS	BUILDING FASTENERS	PMSSS 440 0025 PH
4	Four corners	STANDOFF, 4-40x3/4in, F/F, HEX, ALUMINUM, 0.25 OD, ROHS	KEYSTONE	2204
0	C1-C2, C5, C6, C10, C106-C108, C18, C38, C39, C101-C102, C121, C122	DO NOT POPULATE OR PURCHASE		
0	C27	DO NOT POPULATE OR PURCHASE		
0	C13, C115, C117, C119	DO NOT POPULATE OR PURCHASE		

Qty	Reference Designator	Description	Manufacturer	Manufacturer Part Number
0	C94, C116, C118, C120	DO NOT POPULATE OR PURCHASE		
0	L2	DO NOT POPULATE OR PURCHASE		
0	R94, R101, R103, R105, R107	DO NOT POPULATE OR PURCHASE		
0	C114, C113	DO NOT POPULATE OR PURCHASE		
0	C23, C9, C105, C112, C3, C4	DO NOT POPULATE OR PURCHASE		
0	TP38-TP42	DO NOT POPULATE OR PURCHASE		
0	A, B, C	Leave them open		

2.5 Board Layout

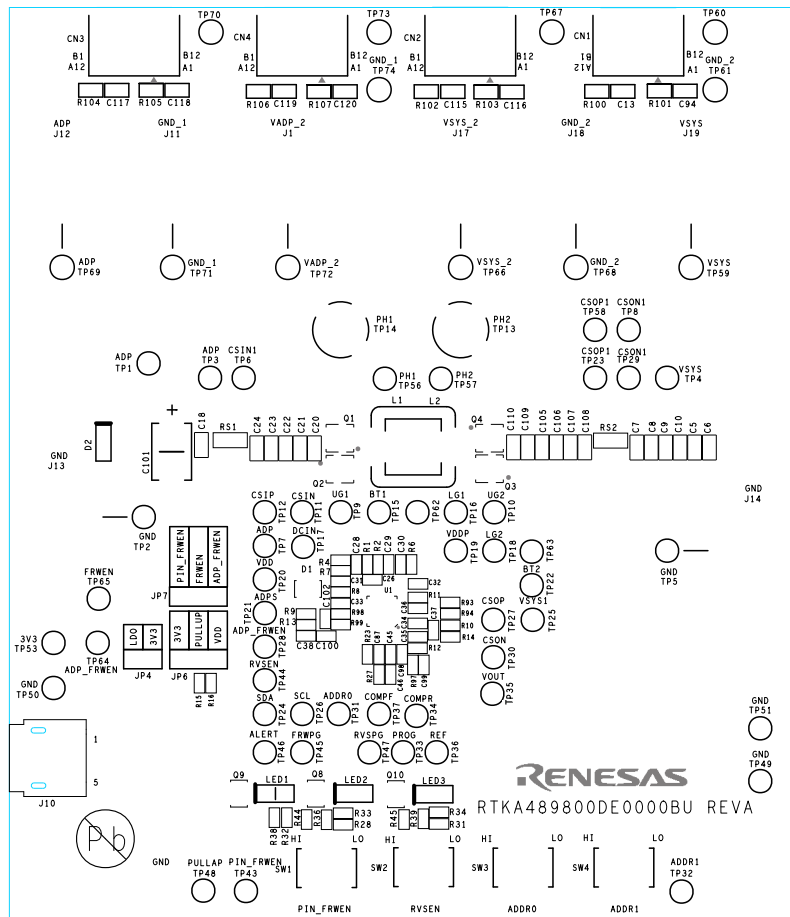

Figure 7. Top Silkscreen Layer

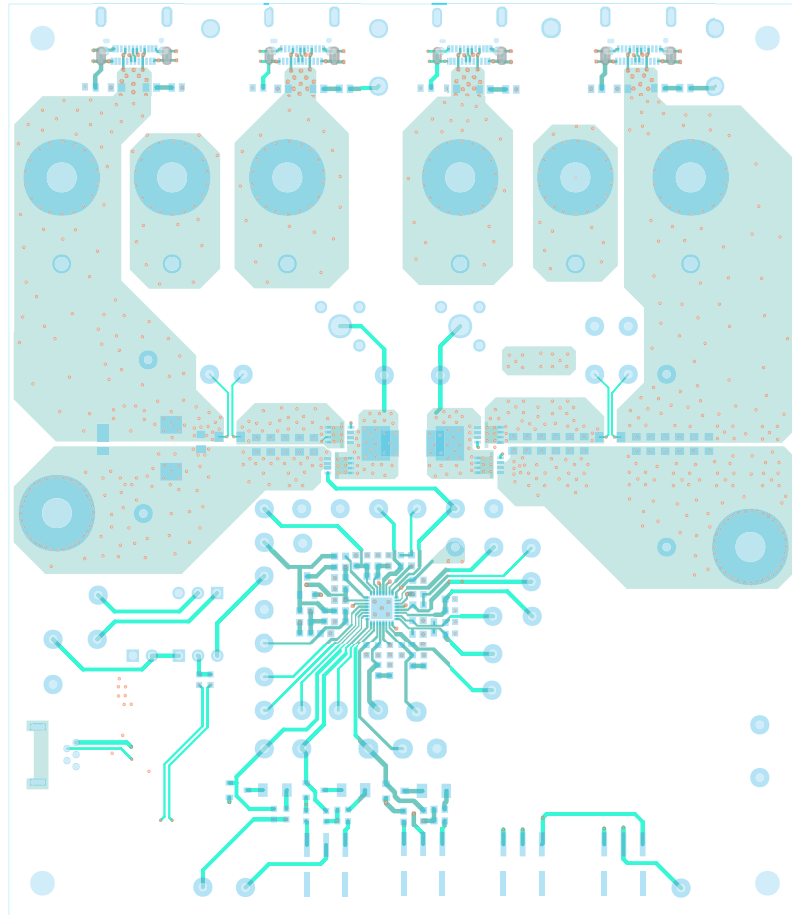

Figure 8. Top Layer

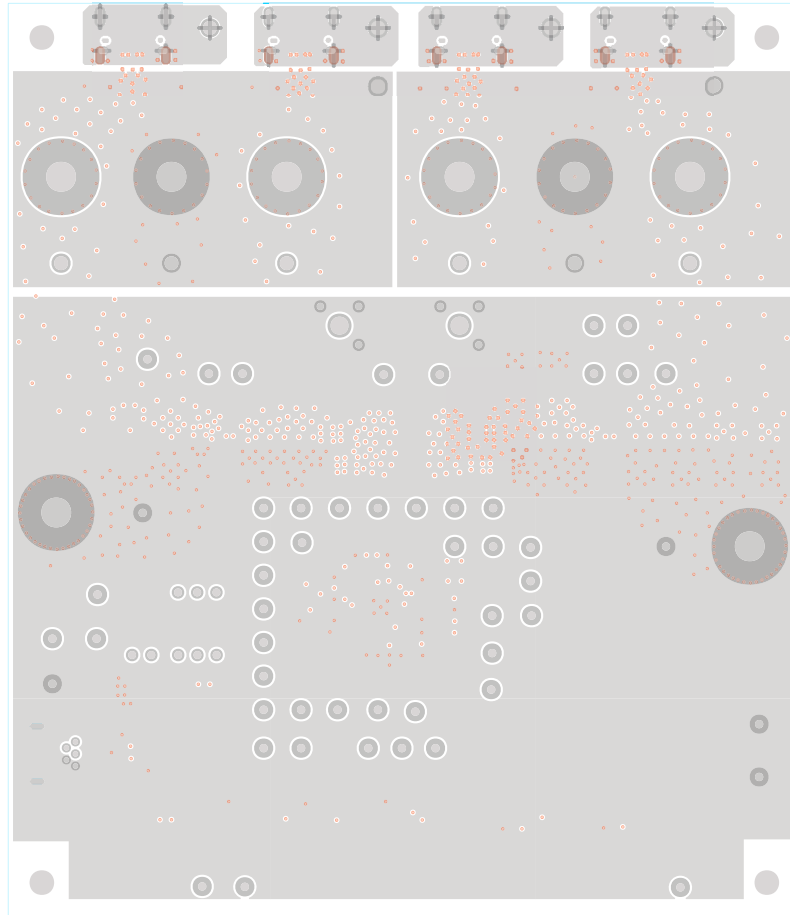

Figure 9. Inner Layer 1

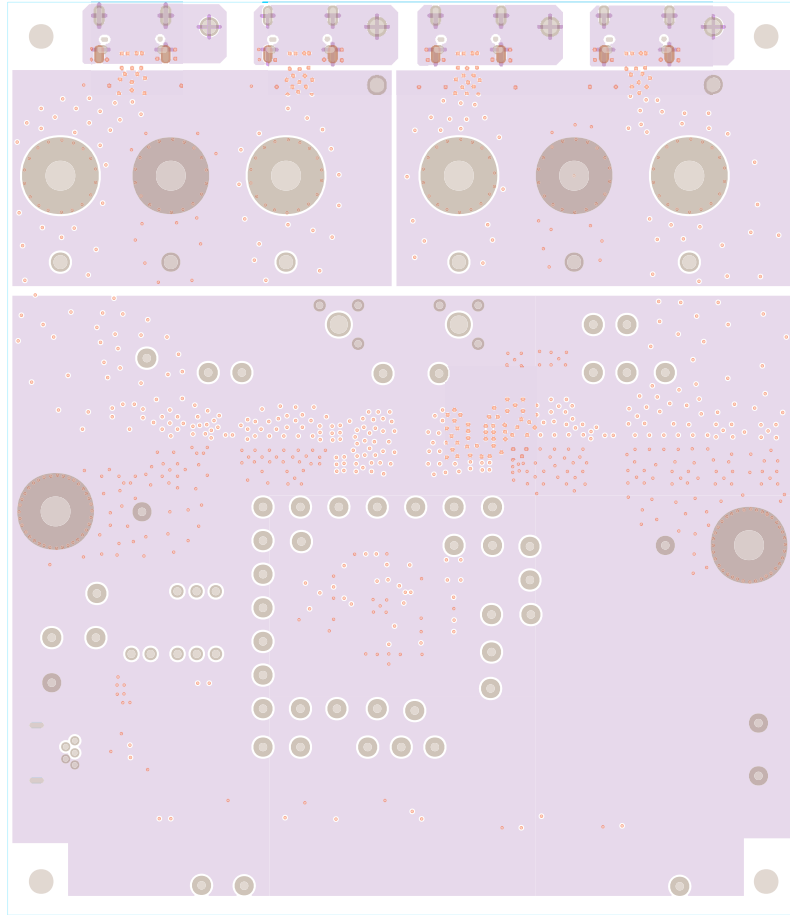

Figure 10. Inner Layer 2

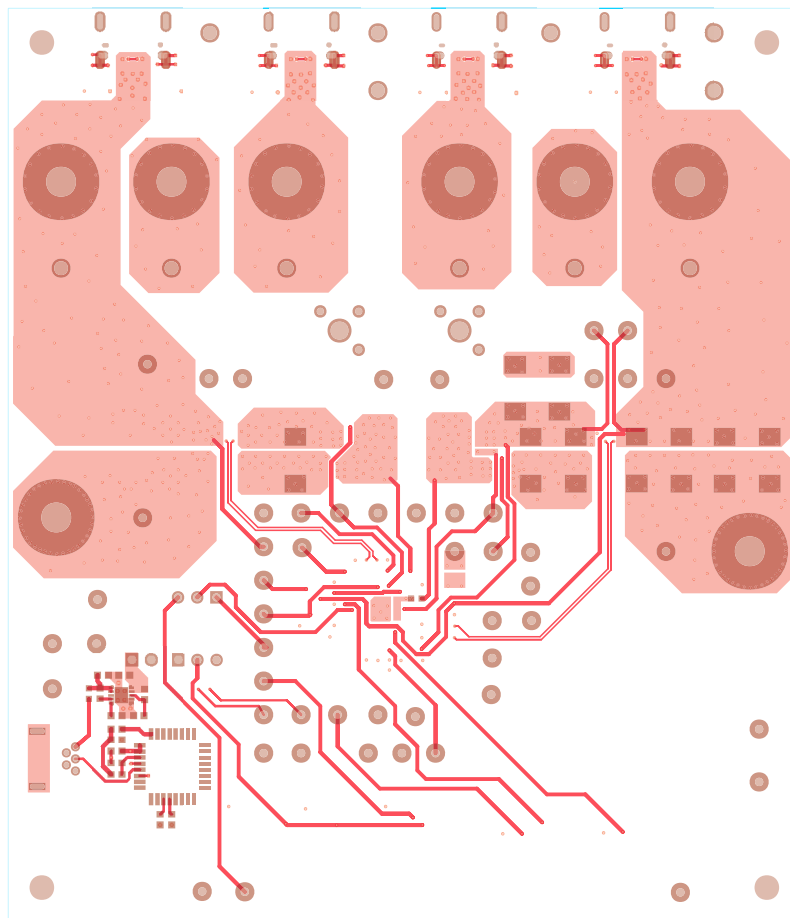

Figure 11. Bottom Layer

3. Typical Performance Curves

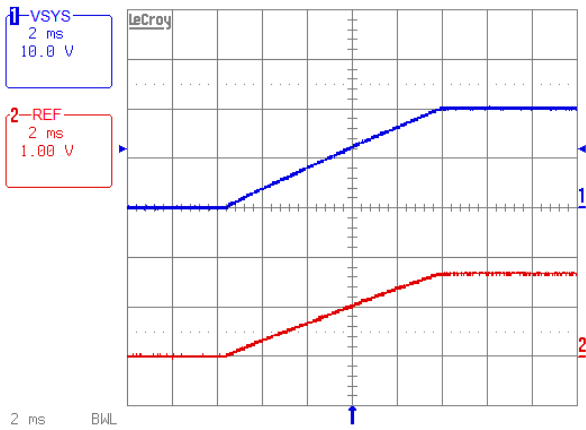

Figure 12. Forward Mode Soft-Start, 12VADP, 20VSYS

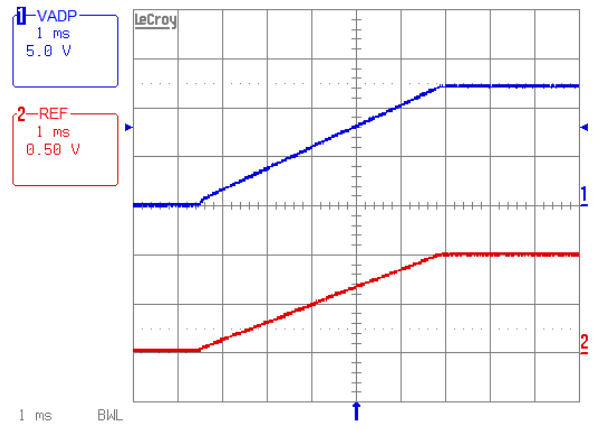

Figure 13. Reverse Mode, Soft-Start, 12VADP, 5VSYS

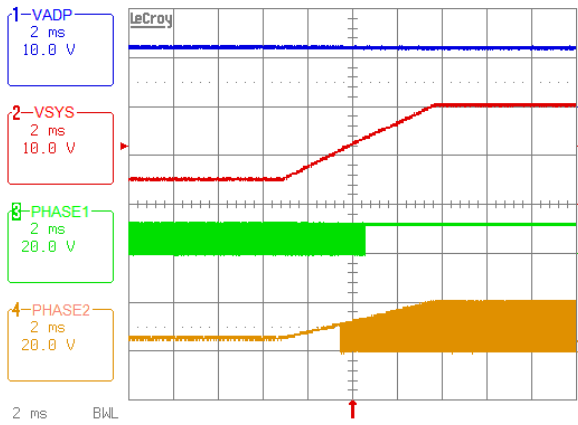

Figure 14. VSYS Voltage Ramps Up in Forward Mode, Buck -> Buck-Boost -> Boost Operation Mode Transition

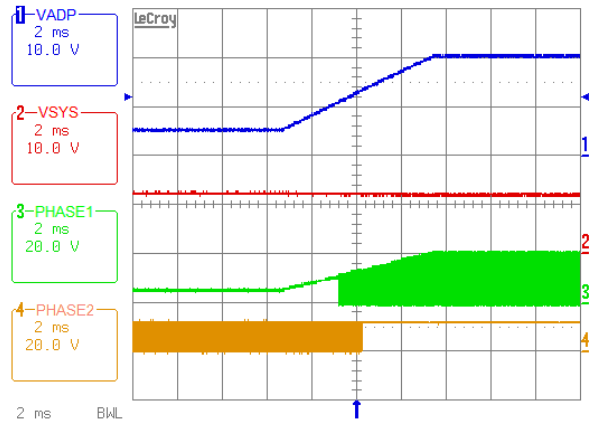

Figure 15. ADP Voltage Ramps Up in Reverse Mode, Buck -> Buck-Boost -> Boost Operation Mode Transition

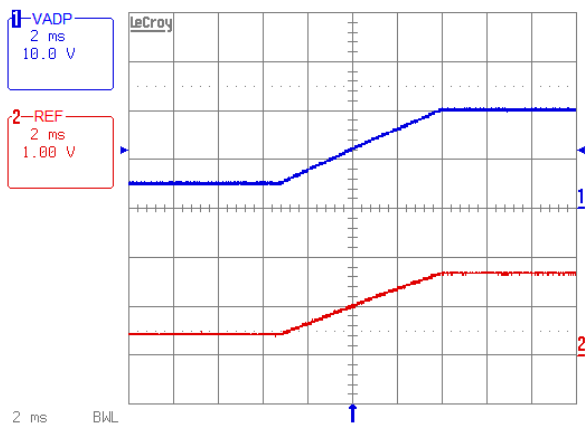

Figure 16. Reverse Mode, 5VADP to 20VADP

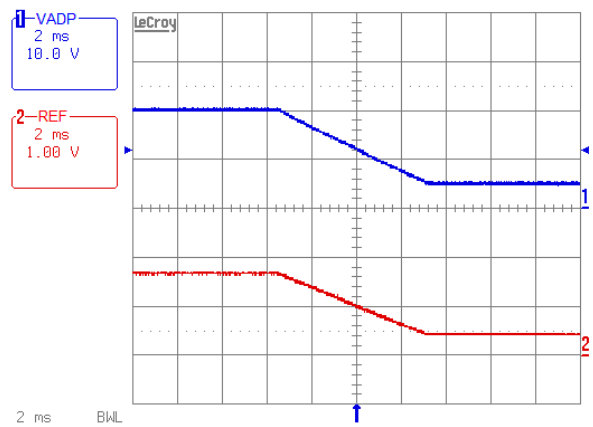

Figure 17. Reverse Mode, 20VADP to 5VADP

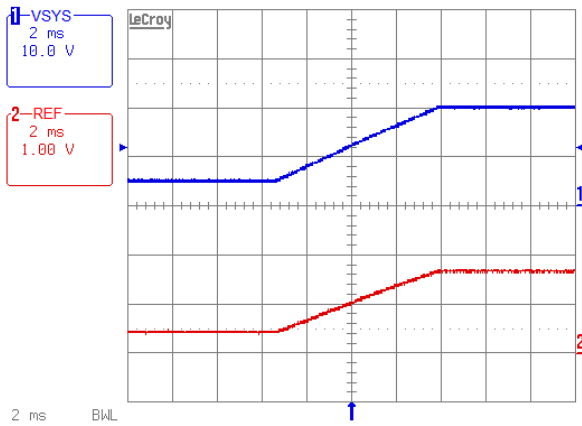

Figure 18. Forward Mode, 5VSYS to 20VSYS

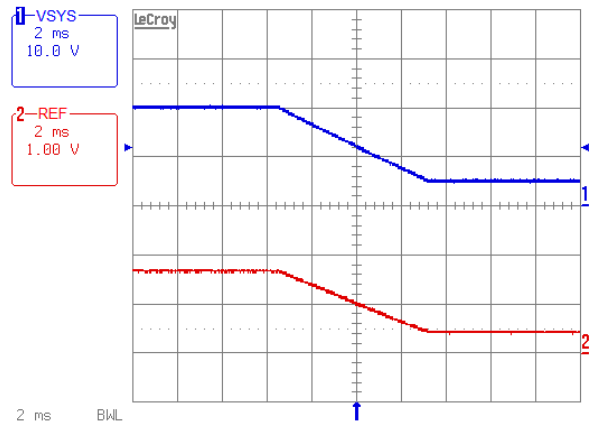

Figure 19. Forward Mode, 20VSYS to 5VSYS

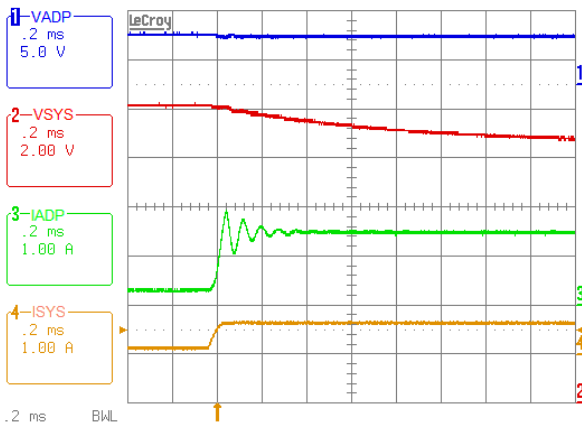

Figure 20. Forward Mode, Output Voltage Loop to ADP Current Loop Transition. 5VADP, 12VSYS, System Load 0A to 0.65A Step, ADP Current Limit = 1.5A

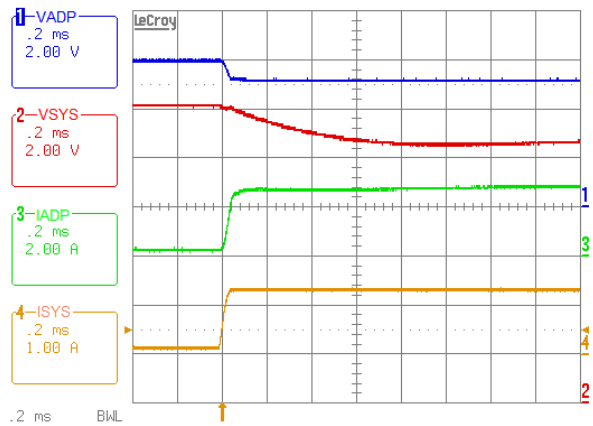

Figure 21. Forward Mode, Output Voltage Loop to Adapter Voltage Loop Transition. 6VADP, Input Voltage Limit = 5.12V, 12VSYS, System Load 0A to 1.3A Step, System Current Limit = 5A, Input Current Limit = 5A

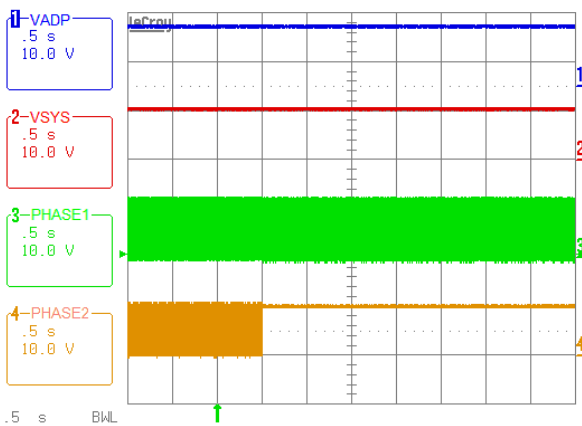

Figure 22. Forward Mode, Force Buck-Boost Mode to Buck Mode. 12VADP, 10.1VSYS

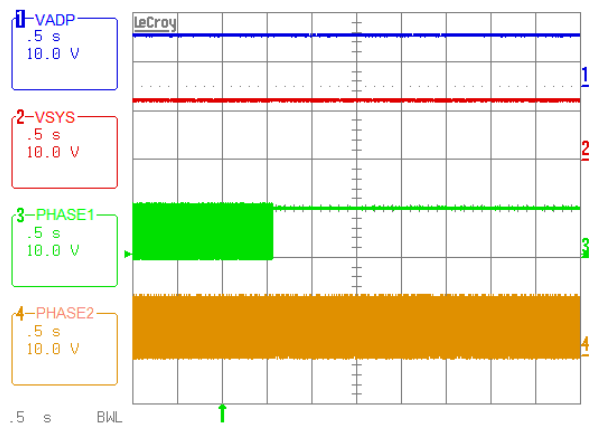

Figure 23. Reverse Mode, Force Buck-Boost Mode to Buck Mode. 10.1VADP, 12VSYS

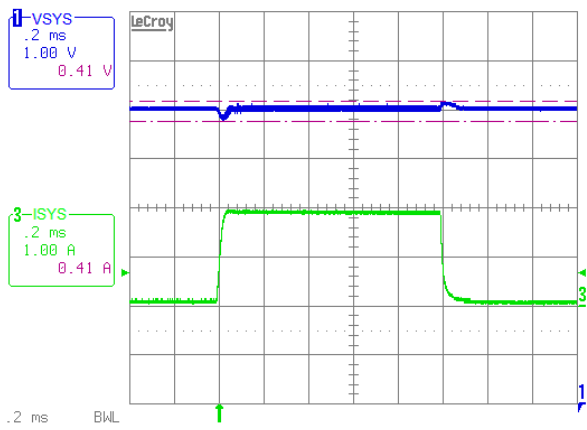

Figure 24. Forward Mode, 5VADP, 12VSY, 0-2A Transient Load

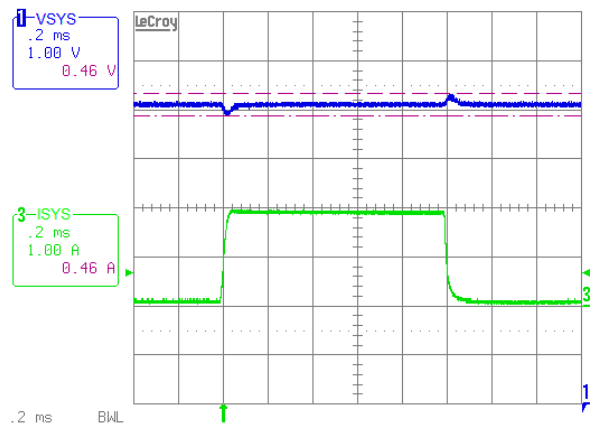

Figure 25. Reverse Mode, 20VADP, 12VSY, 0-2A Transient Load

4. Revision History

Rev.	Date	Description
1.00	Oct.31.19	Initial release

IMPORTANT NOTICE AND DISCLAIMER

RENESAS ELECTRONICS CORPORATION AND ITS SUBSIDIARIES (“RENESAS”) PROVIDES TECHNICAL SPECIFICATIONS AND RELIABILITY DATA (INCLUDING DATASHEETS), DESIGN RESOURCES (INCLUDING REFERENCE DESIGNS), APPLICATION OR OTHER DESIGN ADVICE, WEB TOOLS, SAFETY INFORMATION, AND OTHER RESOURCES “AS IS” AND WITH ALL FAULTS, AND DISCLAIMS ALL WARRANTIES, EXPRESS OR IMPLIED, INCLUDING, WITHOUT LIMITATION, ANY IMPLIED WARRANTIES OF MERCHANTABILITY, FITNESS FOR A PARTICULAR PURPOSE, OR NON-INFRINGEMENT OF THIRD PARTY INTELLECTUAL PROPERTY RIGHTS.

These resources are intended for developers skilled in the art designing with Renesas products. You are solely responsible for (1) selecting the appropriate products for your application, (2) designing, validating, and testing your application, and (3) ensuring your application meets applicable standards, and any other safety, security, or other requirements. These resources are subject to change without notice. Renesas grants you permission to use these resources only for development of an application that uses Renesas products. Other reproduction or use of these resources is strictly prohibited. No license is granted to any other Renesas intellectual property or to any third party intellectual property. Renesas disclaims responsibility for, and you will fully indemnify Renesas and its representatives against, any claims, damages, costs, losses, or liabilities arising out of your use of these resources. Renesas' products are provided only subject to Renesas' Terms and Conditions of Sale or other applicable terms agreed to in writing. No use of any Renesas resources expands or otherwise alters any applicable warranties or warranty disclaimers for these products.

(Rev.1.0 Mar 2020)

Corporate Headquarters

TOYOSU FORESIA, 3-2-24 Toyosu,
Koto-ku, Tokyo 135-0061, Japan
www.renesas.com

Contact Information

For further information on a product, technology, the most up-to-date version of a document, or your nearest sales office, please visit:
www.renesas.com/contact/

Trademarks

Renesas and the Renesas logo are trademarks of Renesas Electronics Corporation. All trademarks and registered trademarks are the property of their respective owners.

RTKA489800DE0000BU