



Emulation Adapter for the RH850/U2A

RTE7702200EAB00000J

User's Manual

All information contained in these materials, including products and product specifications, represents information on the product at the time of publication and is subject to change by Renesas Electronics Corp. without notice. Please review the latest information published by Renesas Electronics Corp. through various means, including the Renesas Electronics Corp. website (<http://www.renesas.com>).

Notice

1. Descriptions of circuits, software and other related information in this document are provided only to illustrate the operation of semiconductor products and application examples. You are fully responsible for the incorporation or any other use of the circuits, software, and information in the design of your product or system. Renesas Electronics disclaims any and all liability for any losses and damages incurred by you or third parties arising from the use of these circuits, software, or information.
2. Renesas Electronics hereby expressly disclaims any warranties against and liability for infringement or any other claims involving patents, copyrights, or other intellectual property rights of third parties, by or arising from the use of Renesas Electronics products or technical information described in this document, including but not limited to, the product data, drawings, charts, programs, algorithms, and application examples.
3. No license, express, implied or otherwise, is granted hereby under any patents, copyrights or other intellectual property rights of Renesas Electronics or others.
4. You shall be responsible for determining what licenses are required from any third parties, and obtaining such licenses for the lawful import, export, manufacture, sales, utilization, distribution or other disposal of any products incorporating Renesas Electronics products, if required.
5. You shall not alter, modify, copy, or reverse engineer any Renesas Electronics product, whether in whole or in part. Renesas Electronics disclaims any and all liability for any losses or damages incurred by you or third parties arising from such alteration, modification, copying or reverse engineering.
6. Renesas Electronics products are classified according to the following two quality grades: "Standard" and "High Quality". The intended applications for each Renesas Electronics product depends on the product's quality grade, as indicated below.

"Standard": Computers; office equipment; communications equipment; test and measurement equipment; audio and visual equipment; home electronic appliances; machine tools; personal electronic equipment; industrial robots; etc.

"High Quality": Transportation equipment (automobiles, trains, ships, etc.); traffic control (traffic lights); large-scale communication equipment; key financial terminal systems; safety control equipment; etc.

Unless expressly designated as a high reliability product or a product for harsh environments in a Renesas Electronics data sheet or other Renesas Electronics document, Renesas Electronics products are not intended or authorized for use in products or systems that may pose a direct threat to human life or bodily injury (artificial life support devices or systems; surgical implantations; etc.), or may cause serious property damage (space system; undersea repeaters; nuclear power control systems; aircraft control systems; key plant systems; military equipment; etc.). Renesas Electronics disclaims any and all liability for any damages or losses incurred by you or any third parties arising from the use of any Renesas Electronics product that is inconsistent with any Renesas Electronics data sheet, user's manual or other Renesas Electronics document.

7. No semiconductor product is absolutely secure. Notwithstanding any security measures or features that may be implemented in Renesas Electronics hardware or software products, Renesas Electronics shall have absolutely no liability arising out of any vulnerability or security breach, including but not limited to any unauthorized access to or use of a Renesas Electronics product or a system that uses a Renesas Electronics product. RENESAS ELECTRONICS DOES NOT WARRANT OR GUARANTEE THAT RENESAS ELECTRONICS PRODUCTS, OR ANY SYSTEMS CREATED USING RENESAS ELECTRONICS PRODUCTS WILL BE INVULNERABLE OR FREE FROM CORRUPTION, ATTACK, VIRUSES, INTERFERENCE, HACKING, DATA LOSS OR THEFT, OR OTHER SECURITY INTRUSION ("Vulnerability Issues"). RENESAS ELECTRONICS DISCLAIMS ANY AND ALL RESPONSIBILITY OR LIABILITY ARISING FROM OR RELATED TO ANY VULNERABILITY ISSUES. FURTHERMORE, TO THE EXTENT PERMITTED BY APPLICABLE LAW, RENESAS ELECTRONICS DISCLAIMS ANY AND ALL WARRANTIES, EXPRESS OR IMPLIED, WITH RESPECT TO THIS DOCUMENT AND ANY RELATED OR ACCOMPANYING SOFTWARE OR HARDWARE, INCLUDING BUT NOT LIMITED TO THE IMPLIED WARRANTIES OF MERCHANTABILITY, OR FITNESS FOR A PARTICULAR PURPOSE.
8. When using Renesas Electronics products, refer to the latest product information (data sheets, user's manuals, application notes, "General Notes for Handling and Using Semiconductor Devices" in the reliability handbook, etc.), and ensure that usage conditions are within the ranges specified by Renesas Electronics with respect to maximum ratings, operating power supply voltage range, heat dissipation characteristics, installation, etc. Renesas Electronics disclaims any and all liability for any malfunctions, failure or accident arising out of the use of Renesas Electronics products outside of such specified ranges.
9. Although Renesas Electronics endeavors to improve the quality and reliability of Renesas Electronics products, semiconductor products have specific characteristics, such as the occurrence of failure at a certain rate and malfunctions under certain use conditions. Unless designated as a high reliability product or a product for harsh environments in a Renesas Electronics data sheet or other Renesas Electronics document, Renesas Electronics products are not subject to radiation resistance design. You are responsible for implementing safety measures to guard against the possibility of bodily injury, injury or damage caused by fire, and/or danger to the public in the event of a failure or malfunction of Renesas Electronics products, such as safety design for hardware and software, including but not limited to redundancy, fire control and malfunction prevention, appropriate treatment for aging degradation or any other appropriate measures. Because the evaluation of microcomputer software alone is very difficult and impractical, you are responsible for evaluating the safety of the final products or systems manufactured by you.
10. Please contact a Renesas Electronics sales office for details as to environmental matters such as the environmental compatibility of each Renesas Electronics product. You are responsible for carefully and sufficiently investigating applicable laws and regulations that regulate the inclusion or use of controlled substances, including without limitation, the EU RoHS Directive, and using Renesas Electronics products in compliance with all these applicable laws and regulations. Renesas Electronics disclaims any and all liability for damages or losses occurring as a result of your noncompliance with applicable laws and regulations.
11. Renesas Electronics products and technologies shall not be used for or incorporated into any products or systems whose manufacture, use, or sale is prohibited under any applicable domestic or foreign laws or regulations. You shall comply with any applicable export control laws and regulations promulgated and administered by the governments of any countries asserting jurisdiction over the parties or transactions.
12. It is the responsibility of the buyer or distributor of Renesas Electronics products, or any other party who distributes, disposes of, or otherwise sells or transfers the product to a third party, to notify such third party in advance of the contents and conditions set forth in this document.
13. This document shall not be reprinted, reproduced or duplicated in any form, in whole or in part, without prior written consent of Renesas Electronics.
14. Please contact a Renesas Electronics sales office if you have any questions regarding the information contained in this document or Renesas Electronics products.

(Note1) "Renesas Electronics" as used in this document means Renesas Electronics Corporation and also includes its directly or indirectly controlled subsidiaries.

(Note2) "Renesas Electronics product(s)" means any product developed or manufactured by or for Renesas Electronics.

(Rev.5.0-1 October 2020)

Corporate Headquarters

TOYOSU FORESIA, 3-2-24 Toyosu,
Koto-ku, Tokyo 135-0061, Japan

www.renesas.com

Trademarks

Renesas and the Renesas logo are trademarks of Renesas Electronics Corporation. All trademarks and registered trademarks are the property of their respective owners.

Contact information

For further information on a product, technology, the most up-to-date version of a document, or your nearest sales office, please visit:
www.renesas.com/contact/.

Preface

The emulation adapter is an emulation board which is designed for use with RH850 family MCUs from Renesas Electronics Corporation.

All components that come with the emulation adapter are listed under “1.1 Package Components”. If you have any questions about the emulation adapter, contact your local distributor.

This user’s manual is mainly to describe the specifications of the emulation adapter. For the specifications of the exchange adapters, refer to appendix A, Specifications of the Exchange Adapters, in this document.

For information on emulator debuggers and related products, please see the user’s manuals, additional documents for user’s manuals, and application notes provided for the individual products. When you use an emulator from another company for debugging, be sure to read the user’s manual for the given emulator.

Related Documents

Name of Document	Document No.
IE850A Emulator RTE0T0850AKCT00000J User’s Manual	R20UT4461E
E2 Emulator RTE0T00020KCE00000R User’s Manual	R20UT3538E
E2 Emulator, IE850A Emulator Additional Document for User’s Manual (Notes on Connection of RH850/U2A)	R20UT4381E

Note: The contents of the related documents listed above may be changed without prior notice. Be sure to use the latest versions of the documents, which can be downloaded from “Software and Tools” on the Renesas Web page.

<https://www.renesas.com/>

Important

Before using this product, be sure to read this user's manual carefully.

Keep this user's manual, and refer to it when you have questions about this product.

Purpose of use of this product:

This product is for the support of the development of systems that use RH850-family MCUs from Renesas. It provides support for system development in both software and hardware.

Be sure to use this product correctly according to said purpose of use. Please avoid using this product other than for its intended purpose of use.

For those who use this product:

This product can only be used by those who have carefully read the user's manual and know how to use it.

Use of this product requires basic knowledge of electric circuits, logical circuits, and MCUs.

When using the product:

- (1) This product is a development-support unit for use in your program development and evaluation stages. When a program you have finished developing is to be incorporated in a mass-produced product, the judgment as to whether it can be put to practical use is entirely your own responsibility, and should be based on evaluation of the device on which it is installed and other experiments.
- (2) In no event shall Renesas Electronics Corp. be liable for any consequence arising from the use of this product.
- (3) Renesas Electronics Corp. strives to provide workarounds for and correct trouble with products malfunctions, with some free and some incurring charges. However, this does not necessarily mean that Renesas Electronics Corp. guarantees the provision of a workaround or correction under any circumstances.
- (4) The product covered by this document has been developed on the assumption that it will be used for program development and evaluation in laboratories. Therefore, it does not fall within the scope of applicability of the Electrical Appliance and Material Safety Law and protection against electromagnetic interference when used in Japan.
- (5) Renesas Electronics Corp. cannot predict all possible situations and possible cases of misuse that carry a potential for danger. Therefore, the warnings in this user's manual and the warning labels attached to the product do not necessarily cover all such possible situations and cases. The customer is responsible for correctly and safely using this product.
- (6) The product covered by this document has been through the process of checking conformance with the standards indicated in section 1.3, Regulatory Compliance Notices. This fact must be taken into account when the product is taken from Japan to another country.
- (7) Renesas Electronics Corp. will not assume responsibility for direct or indirect damage caused by an accidental failure or malfunction of this product.

When disposing of the product:

Penalties may be applicable for incorrect disposal of this waste, in accordance with your national legislation.

Usage restrictions:

The product has been developed as a means of supporting system development by users. Therefore, do not use it as an embedded device in other equipment. Also, do not use it to develop systems or equipment for use in the following fields.

- (1) Transportation and vehicular
- (2) Medical (equipment that has an involvement in human life)
- (3) Aerospace
- (4) Nuclear power control
- (5) Undersea repeaters

If you are considering the use of the product for one of the above purposes, please be sure to consult your local distributor.

About product changes:

We are constantly making efforts to improve the design and performance of this product. Therefore, the specification or design of this product, or this user's manual, may be changed without prior notice.

About rights:

- (1) We assume no responsibility for any damage or infringement on patent rights or any other rights arising from the use of any information, products or circuits presented in this user's manual.
- (2) The information or data in this user's manual does not implicitly or otherwise grant a license to patent rights or any other rights belonging to Renesas or to a third party.
- (3) This user's manual and this product are copyrighted, with all rights reserved by Renesas. This user's manual may not be copied, duplicated or reproduced, in whole or part, without prior written consent from Renesas.

About diagrams:

Some diagrams in this user's manual may differ from the objects they represent.

Precautions for Safety

This chapter describes the precautions which should be taken in order to use this product safely and properly. Be sure to read and understand this chapter before using this product. Contact your local distributor if you have any questions about the precautions described here.



WARNING indicates a potentially dangerous situation that will cause death or heavy wound unless it is avoided.



CAUTION indicates a potentially dangerous situation that will cause a slight injury or a medium-degree injury unless it is avoided.

To avoid a possible danger, the following diagrammatic symbols are used to call your attention.

△ means WARNING or CAUTION.

Example:



CAUTION AGAINST AN ELECTRIC SHOCK

⊘ means PROHIBITION.

Example:



DISASSEMBLY PROHIBITED

● means A FORCIBLE ACTION.

Example:



UNPLUG THE POWER CABLE FROM THE RECEPTACLE.

WARNING

Warnings for AC Power Supply:



Do not repair or remodel the emulator product by yourself in order to prevent danger such as an electric shock or fire and for the sake of quality assurance. For after-sale services in case of a mechanical or electrical fault, please contact your local distributor.

Always switch off the user system before connecting or disconnecting any connectors or cables. Neglecting to take this precaution may result in an electric shock or in this product emitting smoke or catching fire. Also, a user program being debugged may be destroyed.

Make sure that the connectors and cables are connected in the correct directions.

Neglect of this precaution will result in getting an electric shock or will result in this product emitting smoke or catching fire.

Warning for Modification:



Do not modify this product. Personal injury due to electric shock may occur if the product is modified. Modifying the product will void your warranty.

Warning for Installation:



Do not set this product in water or areas of high humidity. Make sure that the product does not get wet. Spilling water or some other liquid into the product may cause un-repairable damage.

Warning for Use Temperature:



This product is to be used in an environment with a maximum ambient temperature of 40°C.

Care should be taken that this temperature is not exceeded.

CAUTION

Cautions to Be Taken for Handling This Product:



Use caution when handling this product. Be careful not to apply a mechanical shock.

Do not operate switches before removing static electricity from the operator's body. Doing so may lead to the discharge of static electricity and so damage the internal circuits. Also, do not directly touch connector pins.

When attaching and removing the cable, hold a fixture (such as a connector) to avoid pulling the cable.

Caution to Be Taken for System Malfunctions:



If this product malfunctions because of interference like external noise, do the following to remedy the trouble.

- (1) Exit the emulator debugger, and turn off the emulator and the target system.
- (2) After a lapse of 10 seconds, turn on the power of this product again, then launch the emulator debugger.

Caution to Be Taken for Disposal:



Penalties may be applicable for incorrect disposal of this waste, in accordance with your national legislation.

European Union Regulatory Notices:



The WEEE (Waste Electrical and Electronic Equipment) regulations put responsibilities on producers for the collection and recycling or disposal of electrical and electronic waste. Return of WEEE under these regulations is applicable in the European Union only. This equipment (including all accessories) is not intended for household use. After use the equipment cannot be disposed of as household waste, and the WEEE must be treated, recycled and disposed of in an environmentally sound manner.

Renesas Electronics Europe GmbH can take back end of life equipment, register for this service at "<http://www.renesas.eu/weee>".

Contents

Preface	3
Important	4
Precautions for Safety	6
Contents	9
Terminology.....	10
1. Outline	1
1.1 Package Components.....	1
1.2 Product Specifications	2
1.3 Regulatory Compliance Notices	3
2. Names and Functions of Hardware	5
2.1 Emulation Adapter (RTE7702200EAB00000J)	5
2.2 Base Board (RTE7702200EABBB000J).....	11
2.3 34-Pin to 14-Pin Conversion Adapter (RTE0T00020KCA30000J).....	16
2.4 Power-Supply Cable	17
2.5 Demounting Lever.....	18
3. System Configuration and Setup	19
3.1 System Configuration as a Simple Evaluation Board	19
3.2 System Configuration as an Emulation Board.....	24
4. Notes	30
4.1 Setting Option Bytes	30
4.2 Notes on Differences between the Actual Device and the Emulation Adapter.....	31
4.3 Note on Debugging	32
5. Characteristics of Target Interface.....	33
6. Maintenance and Warranty.....	34
6.1 Maintenance	34
6.2 Warranty.....	34
6.3 Repair Provisions	34
6.4 How to Request Repairs	35
Appendix A Specifications of the Exchange Adapters	36
Revision History.....	46

Terminology

Some specific words used in this user's manual are defined below.

Target device

This means the device to be emulated or debugged.

Debug chip

This means the device that emulates the operation of the target device and implements debugging facilities such as tracing.

Aurora tracing

Aurora is a high-speed communications protocol from Xilinx Inc. The debug chip is capable of using Aurora as a trace interface.

Target system

This means the user-created system which is to be debugged. This includes both hardware and software created by the user.

Emulation adapter

This is a board which emulates the device to be debugged. A debug chip is mounted on the board.

Base board

This board is for operating the emulation adapter as a stand-alone unit.

Exchange adapter

This is a board that exchanges the connections of the emulation adapter to suit the package of the target device.

1. Outline

This product is an emulation adapter for the RH850/U2A of MCUs from Renesas Electronics Corporation. Using this product with the separately sold exchange adapter enables emulation of the target device.

Features:

- This product includes a debug chip (R7F702Z19AEDBG) for the RH850/U2A.
- The combination of the emulation adapter connected to the base board included in the package is usable as a simple evaluation board.
- Using the emulation adapter with the exchange adapter allows connection to the target system and enables emulation of the target device.
- Connecting an emulator which supports Aurora tracing, such as the IE850A emulator (type name: RTE0T0850AKCT00000J) from Renesas, enables debugging.
- Using the attached 34-pin to 14-pin conversion connector enables connecting the emulation adapter to on-chip debugging emulators and flash programmers, such as the E2 emulator (type name: RTE0T00020KCE00000R) from Renesas.
- The emulation adapter can operate as a stand-alone unit, i.e. without connection to an emulator.

1.1 Package Components

The package of this product consists of the following items. After you have unpacked the box, check if your emulation adapter contains all of these items.

Table 1-1 Package Components for the Emulation Adapter

Item	Quantity
Emulation adapter: RTE7702200EAB00000J	1
Base board: RTE7702200EABBB000J	1
34-pin to 14-pin conversion adapter: RTE0T00020KCA30000J	1
Power-supply cable	1
Demounting lever	1
Jumper blocks for pin headers (for JP18 of the base board)	1

1.2 Product Specifications

Table 1-2 lists the specifications of this product.

Table 1-2 Product Specifications

Item	Specification
Device to be emulated	516-pin BGA: RH850/U2A16 292-pin BGA: RH850/U2A16, U2A8
Power supply for the emulation adapter	4.5 V min., 5.0 V typ., 5.5 V max.
External dimension	Emulation adapter: 47 mm x 47 mm Base board: 100 mm x 120 mm
Weight	Emulation adapter: 20 g Base board: 72 g
Operating temperature	0 to 40°C (no condensation)
Storage temperature	-15 to 60°C (no condensation)
EMC	EU: EN55032 Class A, EN55024 USA: FCC part 15 Class A

1.3 Regulatory Compliance Notices

- European Union regulatory notices

This product complies with the following EU Directives. (These directives are only valid in the European Union.)

CE Certifications:

This product complies with the following European EMC standards.

- EMC Directive (2014/30/EU)

EN 55032 Class A

WARNING: This is a Class A product. This equipment can cause radio frequency noise when used in the residential area. In such cases, the user/operator of the equipment may be required to take appropriate countermeasures under his responsibility.

EN 55024

Information for traceability:

- Authorised representative & Manufacturer

Name: Renesas Electronics Corporation

Address: TOYOSU FORESIA, 3-2-24, Toyosu, Koto-ku, Tokyo, 135-0061, Japan

- Person responsible for placing on the market

Name: Renesas Electronics Europe GmbH

Address: Arcadiastrasse 10, 40472 Dusseldorf, Germany

- Trademark and Type name

Trademark: Renesas

Product name: RH850/U2A Emulation adapter + Base board

Type name: RTE7702200EAB00000J

Environmental Compliance and Certifications:

- Waste Electrical and Electronic Equipment (WEEE) Directive 2012/19/EU

- United States Regulatory notices on Electromagnetic compatibility

This product complies with the following EMC regulation. (This is only valid in the United States.)

FCC Certifications:

This equipment has been tested and found to comply with the limits for a Class A digital device, pursuant to Part 15 of the FCC Rules. These limits are designed to provide reasonable protection against harmful interference when the equipment is operated in a commercial environment. This equipment generates, uses, and can radiate radio frequency energy and, if not installed and used in accordance with the instruction manual, may cause harmful interference to radio communications. Operation of this equipment in a residential area is likely to cause harmful interference in which case the user will be required to correct the interference at his own expense.

This device complies with Part 15 of the FCC Rules. Operation is subject to the following two conditions: (1) this device may not cause harmful interference, and (2) this device must accept any interference received, including interference that may cause undesired operation.

CAUTION: Changes or modifications not expressly approved by the party responsible for compliance could void the user's authority to operate the equipment.

2. Names and Functions of Hardware

This chapter describes the names and functions of each part of the emulation adapter and of the other items included with it. You can avoid damaging the product and affecting the system by reading this chapter with reference to the actual hardware.

Chapter 3 shows a list of the settings of hardware according to the system configuration (type of usage).

2.1 Emulation Adapter (RTE7702200EAB0000J)

An emulation adapter is an emulation board on which the debug chip is mounted. Using the emulation adapter with the exchange adapter allows connection to the target system. The emulation adapter can also be used as a simple evaluation board in combination with the attached base board.

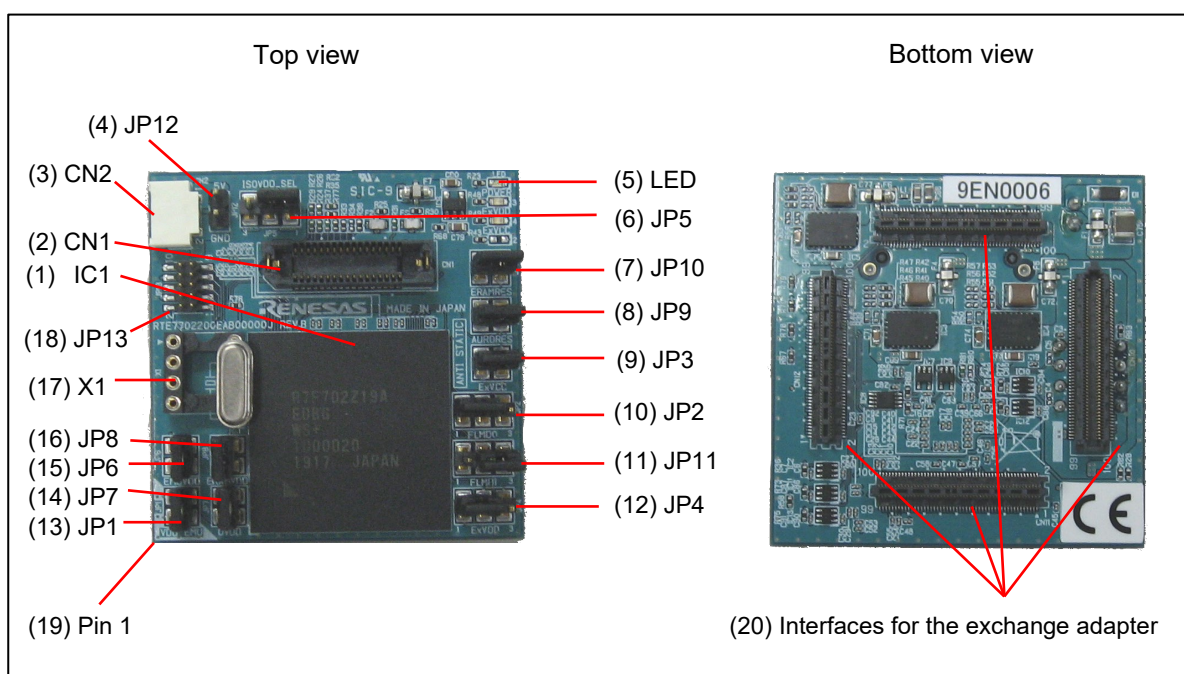

Figure 2-1 Names of the Parts of the Emulation Adapter (RTE7702200EAB0000J)

(1) Debug chip: IC1

IC1 is the debug chip (R7F702Z19AEDBG), which can emulate target devices of the RH850/U2A.

(2) Connector for external tracing: CN1

CN1 is a connector for connection to emulators which support Aurora tracing, such as the IE850A emulator (type name: RTE0T0850AKCT00000J) from Renesas.

CN1 is a 34-pin connector from SAMTEC, the type name of which is ASP-137973-01. The table below lists the pin assignments.

Read the user's manual for the emulator you will be using and connect the emulator with this connector.



Table 2-1 Pin Assignments of the Connector for External Tracing

Signal Name	Pin No.	Pin No.	Signal Name
GND	Latch		
TODP0	1	2	TVCC (E0VCC)
TODN0	3	4	TCK/LPDCLK
GND	5	6	TMS
TODP1	7	8	TDI/LPDI
TODN1	9	10	TDO/LPDO
GND	11	12	TRST/LPDRST
TODP2	13	14	FPMD0 (FLMD0)
TODN2	15	16	EVTI
GND	17	18	EVTO
TODP3	19	20	FPMD1 (FLMD1)
TODN3	21	22	RESET
GND	23	24	GND
MSYNZ	25	26	CICREFP
N.C.	27	28	CICREFN
GND	29	30	GND
N.C.	31	32	DRDY/LPDCLK0
N.C.	33	34	RESOUT (P6_10)
GND	Latch		GND

(3) Power-supply connector: CN2

CN2 is connected to the power-supply cable that comes with this product or that comes with the IE850A. When a base board is connected and emulation RAM (ERAM) or external tracing (Aurora tracing) is used, be sure to connect the power-supply cable to CN2 and supply +5 V.

When disconnecting the power-supply cable from the emulation adapter, press the tabs on both sides of the CN1 connector of the power-supply cable to unlock the connector.

 CAUTION	
Applied voltage:	
	Make sure that the voltage applied to CN2 is within the specified range (4.5 V to 5.5 V). An applied voltage out of the range may cause the emulation adapter to emit smoke or catch fire or otherwise be damaged.

CAUTION

Unlocking the connector:



Do not press the tabs for unlocking the connector too hard as this may lead to them being stuck in this position. Take care on this point.

(4) Power-supply pin header: JP12

JP12 is a pin header which allows the monitoring of +5 V and GND that are supplied from CN2.

(5) Status LEDs

Name of LED	Specification
POWER	Illuminated: CN2 is supplying power. Not illuminated: CN2 is not supplying power.
ExVDD	Illuminated: VDD for debugging (EMUVDD, DVDD, or ERAMVDD) = ON Not illuminated: VDD for debugging (EMUVDD, DVDD, or ERAMVDD) = OFF This specification depends on the settings of JP1 or JP4; it does not depend on those of JP6, JP7, or JP8.
ExVCC	Illuminated: VCC for debugging (EMUVCC, DVCC, or ERAMVCC) = ON Not illuminated: VCC for debugging (EMUVCC, DVCC, or ERAMVCC) = OFF This specification depends on the settings of JP3.

(6) Jumper block: JP5 (ISOVDD_SEL)

JP5 (ISOVDD_SEL)	Specification
Open-circuit	Setting prohibited.
1-2 short-circuit (default)	The power generated from the emulation adapter is used as VDD for the debug chip.
2-3 short-circuit	VDD on the target system is used as VDD for the debug chip.

(7) Jumper block: JP10 (ERAMRES)

JP10 (ERAMRES)	Specification
Open-circuit	This setting is made when ERAM is not to be used. ERAMRESPD and ERAMRES2 pins = low
Short-circuit (default)	This setting is made when ERAM is to be used. The ERAMRESPD and ERAMRES2 pins are controlled in combination with the operation of the TRST and RESET pins. Control specifications: <ul style="list-style-type: none"> On release from a reset by the signal on the TRST or RESET pin (change from low to high), the reset by the signals on the ERAMRESPD and ERAMRES2 pins is released (change from low to high). On the application of a reset by the signal on the TRST or RESET pin (change from high to low), a reset is applied by the signals on the ERAMRESPD and ERAMRES2 pins (change from high to low).

(8) Jumper block: JP9 (AUORES)

JP9 (AUORES)	Specification
Open-circuit	This setting is made when external tracing (Aurora tracing) is not to be used. AUORESPD, AUORES2, and AUORES1 pins = low
Short-circuit (default)	This setting is made when external tracing (Aurora tracing) is to be used. The AUORESPD, AUORES2, and AUORES1 pins are controlled in combination with the operation of the TRST and RESET pins. Control specifications: <ul style="list-style-type: none"> On release from a reset by the signal on the TRST or RESET pin (change from low to high), the reset by the signals on the AUORESPD, AUORES2, and AUORES1 pins is released (change from low to high). On the application of a reset by the signal on the TRST or RESET pin (change from high to low), a reset is applied by the signals on the AUORESPD, AUORES2, and AUORES1 pins (change from high to low).

(9) Jumper block: JP3 (ExVCC)

JP3 (ExVCC)	Specification
Open-circuit	This setting is made when neither ERAM nor external tracing (Aurora tracing) is to be used. VCC for debugging (EMUVCC, DVCC, or ERAMVCC) is not supplied.
Short-circuit (default)	This setting is made when ERAM or external tracing (Aurora tracing) is to be used. VCC for debugging (EMUVCC, DVCC, or ERAMVCC) is supplied.

(10) Jumper block: JP2 (FLMD0)

JP2 (FLMD0)	Specification
Open-circuit	Setting prohibited.
1-2 short-circuit (default)	The FLMD0 pin for the debug chip is controlled by the emulator (CN1 connector for external tracing).
2-3 short-circuit	The FLMD0 pin for the debug chip is controlled by the target system.

(11) Jumper block: JP11 (FLMD1)

JP11 (FLMD1)	Specification
Open-circuit	Setting prohibited.
1-2 short-circuit	The FLMD1 pin for the debug chip is controlled by the emulator (CN1 connector for external tracing).
2-3 short-circuit (default)	The FLMD1 pin for the debug chip is controlled by the target system.

(12) Jumper block: JP4 (ExVDD)**(13) Jumper block: JP1 (VDD_EMU)**

JP1 (VDD_EMU)	JP4 (ExVDD)	Specification
Open-circuit	Open-circuit	Setting prohibited.
	1-2 short-circuit (default)	Neither VDD nor VDD for debugging (EMUVDD, DVDD, or ERAMVDD) is generated from the emulation adapter.
	2-3 short-circuit	Setting prohibited. VDD for debugging (EMUVDD, DVDD, or ERAMVDD) is always generated.
Short-circuit (default)	Open-circuit	Setting prohibited.
	1-2 short-circuit (default)	VDD or VDD for debugging (EMUVDD, DVDD, or ERAMVDD) is generated from the emulation adapter according to the level on the PWRCTL pin of the debug chip.
	2-3 short-circuit	Setting prohibited. VDD for debugging (EMUVDD, DVDD, or ERAMVDD) is always generated.

(14) Jumper block: JP7 (DVDD)

JP7 (DVDD)	Specification
Open-circuit	This setting is made when external tracing (Aurora tracing) is not to be used. Power is not supplied to DVDD.
Short-circuit (default)	This setting is made when external tracing (Aurora tracing) is to be used. Power is supplied to DVDD.

(15) Jumper block: JP6 (EMUVDD)

JP6 (EMUVDD)	Specification
Open-circuit	This setting is made when external tracing (Aurora tracing) is not to be used. Power is not supplied to EMUVDD.
Short-circuit (default)	This setting is made when external tracing (Aurora tracing) is to be used. Power is supplied to EMUVDD.

(16) Jumper block: JP8 (ERAMVDD)

JP8 (ERAMVDD)	Specification
Open-circuit	This setting is made when ERAM is not to be used. Power is not supplied to ERAMVDD.
Short-circuit (default)	This setting is made when ERAM is to be used. Power is supplied to ERAMVDD.

(17) Clock socket: X1

X1 is the socket for the main oscillator. A 40-MHz resonator is mounted upon the board as shipped.

Taking the oscillation characteristics into consideration, an oscillator on the target system is not used; the oscillator in this socket of the emulation adapter is used instead. Change the crystal resonator (Xtal) in the socket if this is required. Mounting a crystal oscillator (EXtal) is also possible. Figure 2-2 shows the clock socket and peripheral circuits.

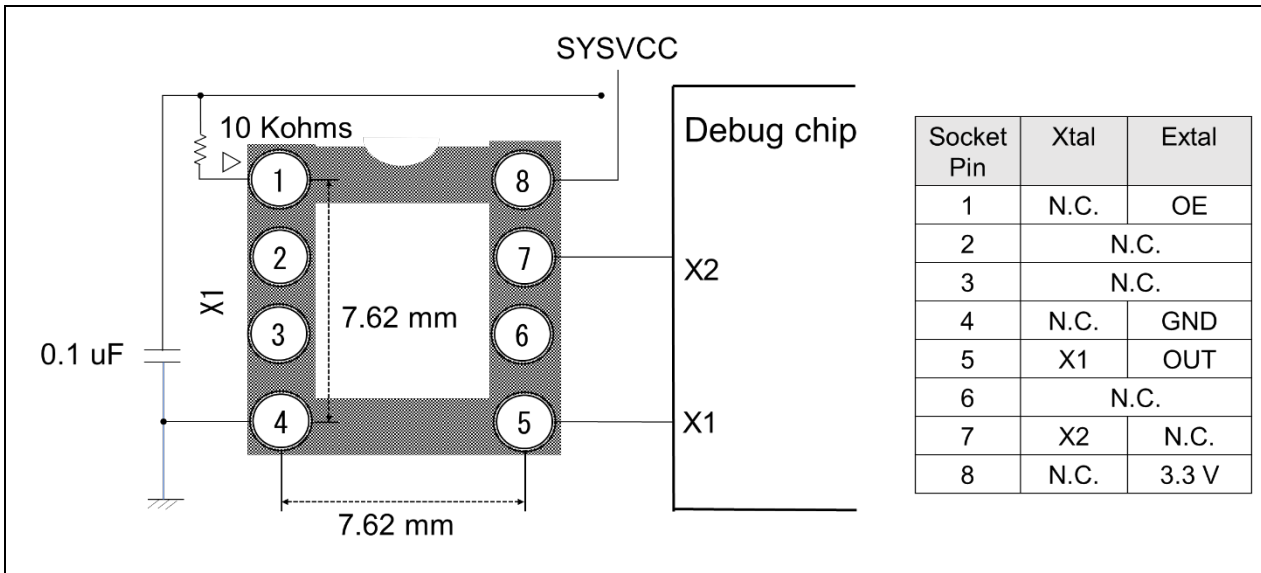

Figure 2-2 Clock Socket and Peripheral Circuits

When mounting a crystal resonator upon the clock socket, insert an insulating sheet between the crystal resonator and clock socket, i.e. mount it in the same way as the 40-MHz resonator is mounted on the product as shipped.

⚠ CAUTION

Insulating sheet:

Make sure that an insulating sheet is inserted between a crystal resonator and clock socket. If this is not the case, the crystal resonator may be short-circuited to pin 8 of the clock socket. This may cause the emulation adapter to emit smoke or catch fire or otherwise damage it.

(18) Pin header: JP13

JP13 is a pin header for the AUD-R pin.

(19) Silk-screened mark for aligning the position of pin 1

This mark indicates the position of pin 1 in the pad pattern for the device to be emulated on the target system.

(20) Interfaces for the exchange adapter: CN10, CN11, CN12, and CN13

These connectors are used to connect an exchange adapter or the base board. CN10 has a different shape from the others to prevent erroneous insertion.

2.2 Base Board (RTE7702200EABBB000J)

The base board allows use as a simple target system in combination with the emulation adapter.

The signals to or from each pin of the debug chip are brought out on CN1 to CN8 on the board, which enables simple checking.

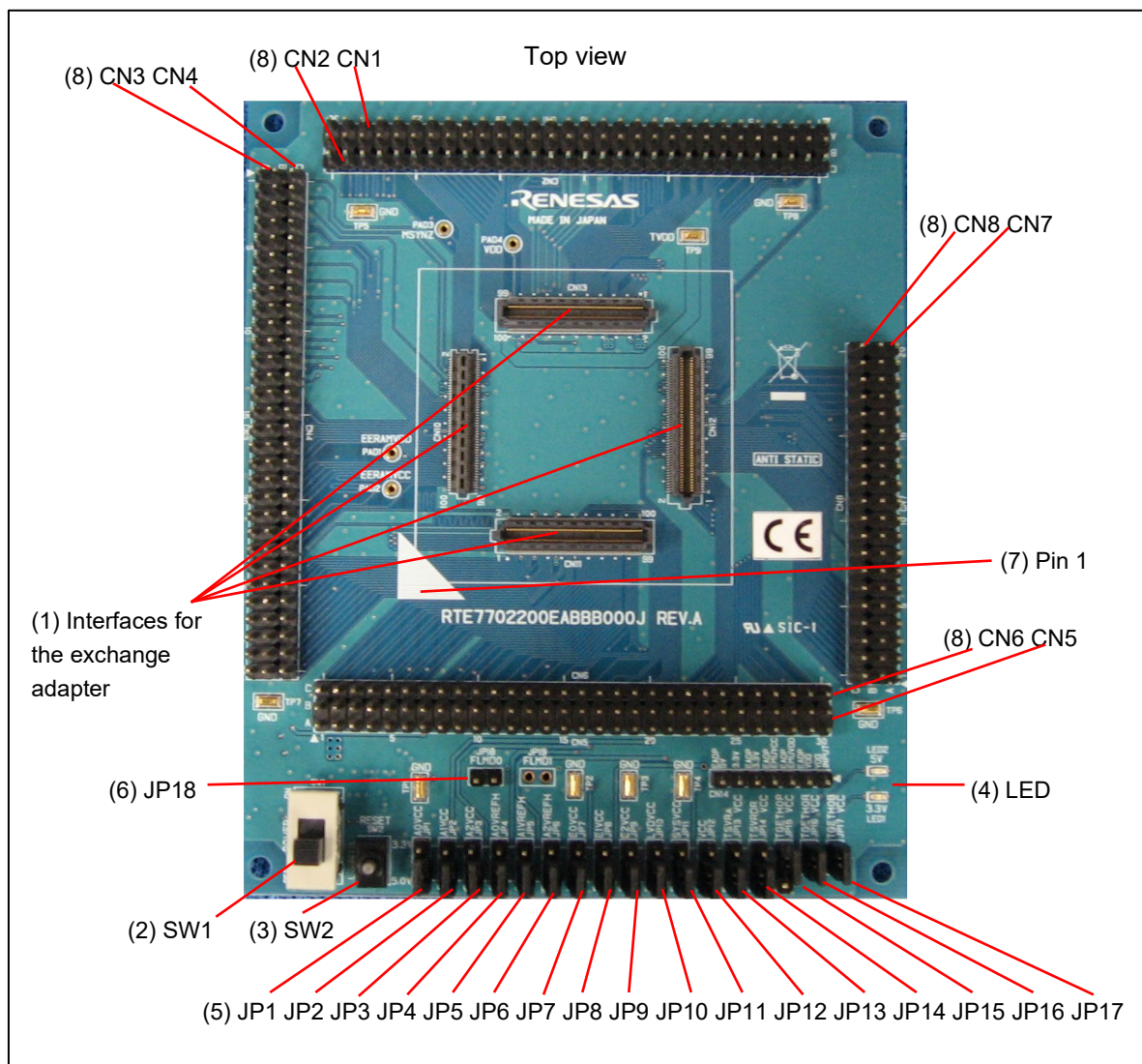
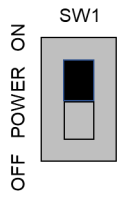
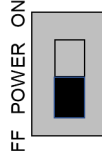



Figure 2-3 Names of the Parts of the Base Board (RTE7702200EABBB000J)

(1) Interfaces for the exchange adapter: CN10, CN11, CN12, and CN13

These connectors are used for connection to the emulation adapter. CN10 has a different shape from the others to prevent erroneous insertion. These connectors are connected to CN10, CN11, CN12, and CN13 of the emulation adapter.

(2) Switch: SW1 (POWER SW)

SW1 (POWER SW)	Specification
<p>ON</p> 	<p>This switch turns on the power supply of the base board.</p> <p>Turn this switch on after connecting the emulation adapter and starting the supply of power from CN2 of the emulation adapter.</p>
<p>OFF</p>  <p>(default)</p>	<p>This switch turns off the power supply of the base board.</p>



CAUTION



Operating the switch:

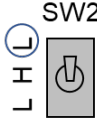
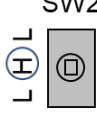
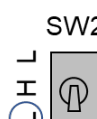

Do not operate a switch before removing static electricity from the operator's body. Doing so may lead to the discharge of static electricity and so damage the internal circuits.

(3) Switch: SW2 (RESET SW)

SW2 (RESET SW)	Specification
<p>(L)</p> 	<p>This position starts release from the reset state after the debug chip has been reset.</p> <p>The switch returns to the "H" position a moment after it stops being pressed.</p> <p>The state of the reset pin of the debug chip changes from "L" to "H" (pulled up).</p>
<p>H</p>  <p>(default)</p>	<p>Reset released state.</p> <p>The reset pin of the debug chip is in the "H" (pulled up) state.</p>
<p>L</p> 	<p>Reset state.</p> <p>The reset pin of the debug chip is in the "L" state.</p>

 CAUTION	
Operating the switch:	
	Do not operate a switch before removing static electricity from the operator's body. Doing so may lead to the discharge of static electricity and so damage the internal circuits.

(4) Status LEDs: LED1 (3.3 V) and LED2 (5 V)





Name of LED	Specification
LED1 (3.3 V)	Illuminated: The 3.3-V power supply on the base board is on. Not illuminated: The 3.3-V power supply on the base board is off.
LED2 (5 V)	Illuminated: The 5-V power supply on the base board is on. Not illuminated: The 5-V power supply on the base board is off.

(5) Jumper blocks: JP1 to JP17 (selecting each of the power-supply voltages)

The target power-supply voltages for each of these jumper blocks are listed below.

JP	Target Power-Supply Voltage
JP1	A0VCC
JP2	A1VCC
JP3	A2VCC
JP4	A0VREFH
JP5	A1VREFH
JP6	A2VREFH
JP7	E0VCC
JP8	E1VCC
JP9	E2VCC
JP10	LVDVCC
JP11	SYSVCC
JP12	VCC
JP13	TSVRAVCC
JP14	TSVRDRVCC
JP15	TGETH0PVCC
JP16	TGETH0RVCC
JP17	TGETH0BVCC

Each jumper block has common specifications as shown in the following table.

JP1 to JP14	Specification
Open-circuit	The target power-supply voltage is off.
1-2 short-circuit (default) 3.3 V  5 V 	5 V is supplied as the target power-supply voltage.
2-3 short-circuit 3.3 V  5 V 	3.3 V is supplied as the target power-supply voltage.

Each jumper block has common specifications as shown in the following table.

JP15 to JP17	Specification
Open-circuit	The target power-supply voltage is off.
Short-circuit (default)	3.3 V is supplied as the target power-supply voltage.

(6) Jumper block: JP18 (FLMD0)

JP17 (MD0)	Specification
Open-circuit (default)	FLMD0 pin = "L" (pulled down)
Short-circuit	FLMD0 pin = "H" (pulled up)

(7) Silk-screened mark for aligning the position of pin 1

When connecting the emulation adapter, match the position of the sticker for aligning the position of pin 1 on the emulation adapter with that of the silk-screened mark for aligning the position of pin 1 on the base board.

(8) Pin headers for controlling and monitoring the pins of the debug chip (CN1 to CN8)

Figure 2-4 shows the assignment of pin headers for each pin of the debug chip.

			<table border="1"> <tr> <td>30</td><td>29</td><td>28</td><td>27</td><td>26</td><td>25</td><td>24</td><td>23</td><td>22</td><td>21</td><td>20</td><td>19</td><td>18</td><td>17</td><td>16</td><td>15</td><td>14</td><td>13</td><td>12</td><td>11</td><td>10</td><td>9</td><td>8</td><td>7</td><td>6</td><td>5</td><td>4</td><td>3</td><td>2</td><td>1</td> </tr> <tr> <td>P2_5</td><td>P2_3</td><td>P2_2</td><td>P2_0</td><td>P5_6</td><td>P0_3</td><td>P0_4</td><td>P2_1</td><td>NC</td><td>TX.D ATAN</td><td>TX.D ATAP</td><td>RX.D ATAP</td><td>RX.D ATAN</td><td>NC</td><td>JP0_0</td><td>JP0_2</td><td>JP0_5</td><td>P6_13</td><td>P6_15</td><td>P6_9</td><td>P6_7</td><td>P6_5</td><td>P6_3</td><td>P6_2</td><td>P6_11</td><td>P3_5</td><td>AP_4.6</td><td>AP_4.8</td><td>AP4_10</td><td>AP4_12</td> </tr> <tr> <td>TX.O LKP</td><td>TX.C LKN</td><td>EVTIZ</td><td>RX.G LKN</td><td>RX.G LKP</td><td>P0_1</td><td>P0_5</td><td>P0_7</td><td>P0_9</td><td>P0_11</td><td>P0_4</td><td>P5_2</td><td>P5_2</td><td>PWR CTL</td><td>GN D</td><td>TRS TZ</td><td>JP0_1</td><td>JP0_3</td><td>P6_14</td><td>P6_10</td><td>P6_12</td><td>P6_8</td><td>P6_4</td><td>P6_4</td><td>P3_4</td><td>AP_4.5</td><td>AP_4.7</td><td>AP_4.9</td><td>AP4_11</td><td>AP_5.3</td><td>P3_0</td> </tr> </table>																														30	29	28	27	26	25	24	23	22	21	20	19	18	17	16	15	14	13	12	11	10	9	8	7	6	5	4	3	2	1	P2_5	P2_3	P2_2	P2_0	P5_6	P0_3	P0_4	P2_1	NC	TX.D ATAN	TX.D ATAP	RX.D ATAP	RX.D ATAN	NC	JP0_0	JP0_2	JP0_5	P6_13	P6_15	P6_9	P6_7	P6_5	P6_3	P6_2	P6_11	P3_5	AP_4.6	AP_4.8	AP4_10	AP4_12	TX.O LKP	TX.C LKN	EVTIZ	RX.G LKN	RX.G LKP	P0_1	P0_5	P0_7	P0_9	P0_11	P0_4	P5_2	P5_2	PWR CTL	GN D	TRS TZ	JP0_1	JP0_3	P6_14	P6_10	P6_12	P6_8	P6_4	P6_4	P3_4	AP_4.5	AP_4.7	AP_4.9	AP4_11	AP_5.3	P3_0																																																																																																																																																																																																																																																																																																																																																																																																																																																																																																																																																																																																																																																																																																																																																																																																																																																																							
30	29	28	27	26	25	24	23	22	21	20	19	18	17	16	15	14	13	12	11	10	9	8	7	6	5	4	3	2	1																																																																																																																																																																																																																																																																																																																																																																																																																																																																																																																																																																																																																																																																																																																																																																																																																																																																																																																																																																					
P2_5	P2_3	P2_2	P2_0	P5_6	P0_3	P0_4	P2_1	NC	TX.D ATAN	TX.D ATAP	RX.D ATAP	RX.D ATAN	NC	JP0_0	JP0_2	JP0_5	P6_13	P6_15	P6_9	P6_7	P6_5	P6_3	P6_2	P6_11	P3_5	AP_4.6	AP_4.8	AP4_10	AP4_12																																																																																																																																																																																																																																																																																																																																																																																																																																																																																																																																																																																																																																																																																																																																																																																																																																																																																																																																																																					
TX.O LKP	TX.C LKN	EVTIZ	RX.G LKN	RX.G LKP	P0_1	P0_5	P0_7	P0_9	P0_11	P0_4	P5_2	P5_2	PWR CTL	GN D	TRS TZ	JP0_1	JP0_3	P6_14	P6_10	P6_12	P6_8	P6_4	P6_4	P3_4	AP_4.5	AP_4.7	AP_4.9	AP4_11	AP_5.3	P3_0																																																																																																																																																																																																																																																																																																																																																																																																																																																																																																																																																																																																																																																																																																																																																																																																																																																																																																																																																																				
			<table border="1"> <tr> <td>1</td><td>2</td><td>3</td><td>4</td><td>5</td><td>6</td><td>7</td><td>8</td><td>9</td><td>10</td><td>11</td><td>12</td><td>13</td><td>14</td><td>15</td><td>16</td><td>17</td><td>18</td><td>19</td><td>20</td><td>21</td><td>22</td><td>23</td><td>24</td><td>25</td><td>26</td><td>27</td><td>28</td><td>29</td><td>30</td> </tr> <tr> <td>P2_7</td><td>NC</td><td>DCDC.N</td><td></td><td></td><td></td><td></td><td></td><td></td><td></td><td></td><td></td><td></td><td></td><td></td><td></td><td></td><td></td><td></td><td></td><td></td><td></td><td></td><td></td><td></td><td></td><td></td><td></td><td></td><td></td> </tr> <tr> <td>P2_9</td><td>NC</td><td>DCDC.P</td><td></td><td></td><td></td><td></td><td></td><td></td><td></td><td></td><td></td><td></td><td></td><td></td><td></td><td></td><td></td><td></td><td></td><td></td><td></td><td></td><td></td><td></td><td></td><td></td><td></td><td></td><td></td> </tr> <tr> <td>P2_8</td><td>P2_10</td><td>P8_9</td><td></td><td></td><td></td><td></td><td></td><td></td><td></td><td></td><td></td><td></td><td></td><td></td><td></td><td></td><td></td><td></td><td></td><td></td><td></td><td></td><td></td><td></td><td></td><td></td><td></td><td></td><td></td> </tr> <tr> <td>P2_12</td><td>P2_14</td><td>P8_7</td><td></td><td></td><td></td><td></td><td></td><td></td><td></td><td></td><td></td><td></td><td></td><td></td><td></td><td></td><td></td><td></td><td></td><td></td><td></td><td></td><td></td><td></td><td></td><td></td><td></td><td></td><td></td> </tr> <tr> <td>P2_11</td><td>P8_10</td><td>P8_5</td><td></td><td></td><td></td><td></td><td></td><td></td><td></td><td></td><td></td><td></td><td></td><td></td><td></td><td></td><td></td><td></td><td></td><td></td><td></td><td></td><td></td><td></td><td></td><td></td><td></td><td></td><td></td> </tr> <tr> <td>P2_13</td><td>P8_8</td><td>P8_3</td><td></td><td></td><td></td><td></td><td></td><td></td><td></td><td></td><td></td><td></td><td></td><td></td><td></td><td></td><td></td><td></td><td></td><td></td><td></td><td></td><td></td><td></td><td></td><td></td><td></td><td></td><td></td> </tr> <tr> <td>P2_15</td><td>P8_6</td><td>P8_1</td><td></td><td></td><td></td><td></td><td></td><td></td><td></td><td></td><td></td><td></td><td></td><td></td><td></td><td></td><td></td><td></td><td></td><td></td><td></td><td></td><td></td><td></td><td></td><td></td><td></td><td></td><td></td> </tr> <tr> <td>P22.3</td><td>P8.4</td><td>P8.0</td><td></td><td></td><td></td><td></td><td></td><td></td><td></td><td></td><td></td><td></td><td></td><td></td><td></td><td></td><td></td><td></td><td></td><td></td><td></td><td></td><td></td><td></td><td></td><td></td><td></td><td></td><td></td> </tr> <tr> <td>P22.4</td><td>P8.2</td><td>P21.0</td><td></td><td></td><td></td><td></td><td></td><td></td><td></td><td></td><td></td><td></td><td></td><td></td><td></td><td></td><td></td><td></td><td></td><td></td><td></td><td></td><td></td><td></td><td></td><td></td><td></td><td></td><td></td> </tr> <tr> <td>P22.1</td><td>P20.1</td><td>P21.1</td><td></td><td></td><td></td><td></td><td></td><td></td><td></td><td></td><td></td><td></td><td></td><td></td><td></td><td></td><td></td><td></td><td></td><td></td><td></td><td></td><td></td><td></td><td></td><td></td><td></td><td></td><td></td> </tr> <tr> <td>P22.2</td><td>P20.3</td><td>P21.2</td><td></td><td></td><td></td><td></td><td></td><td></td><td></td><td></td><td></td><td></td><td></td><td></td><td></td><td></td><td></td><td></td><td></td><td></td><td></td><td></td><td></td><td></td><td></td><td></td><td></td><td></td><td></td> </tr> <tr> <td>P22.0</td><td>P20.5</td><td>P21.3</td><td></td><td></td><td></td><td></td><td></td><td></td><td></td><td></td><td></td><td></td><td></td><td></td><td></td><td></td><td></td><td></td><td></td><td></td><td></td><td></td><td></td><td></td><td></td><td></td><td></td><td></td><td></td> </tr> <tr> <td>P20.0</td><td>P20.7</td><td>P21.4</td><td></td><td></td><td></td><td></td><td></td><td></td><td></td><td></td><td></td><td></td><td></td><td></td><td></td><td></td><td></td><td></td><td></td><td></td><td></td><td></td><td></td><td></td><td></td><td></td><td></td><td></td><td></td> </tr> <tr> <td>P20.2</td><td>P20.9</td><td>P23.13</td><td></td><td></td><td></td><td></td><td></td><td></td><td></td><td></td><td></td><td></td><td></td><td></td><td></td><td></td><td></td><td></td><td></td><td></td><td></td><td></td><td></td><td></td><td></td><td></td><td></td><td></td><td></td> </tr> <tr> <td>P20.4</td><td>P20.12</td><td>P23.11</td><td></td><td></td><td></td><td></td><td></td><td></td><td></td><td></td><td></td><td></td><td></td><td></td><td></td><td></td><td></td><td></td><td></td><td></td><td></td><td></td><td></td><td></td><td></td><td></td><td></td><td></td><td></td> </tr> <tr> <td>P20.6</td><td>P23.12</td><td>P23.9</td><td></td><td></td><td></td><td></td><td></td><td></td><td></td><td></td><td></td><td></td><td></td><td></td><td></td><td></td><td></td><td></td><td></td><td></td><td></td><td></td><td></td><td></td><td></td><td></td><td></td><td></td><td></td> </tr> <tr> <td>P20.8</td><td>P23.10</td><td>P23.7</td><td></td><td></td><td></td><td></td><td></td><td></td><td></td><td></td><td></td><td></td><td></td><td></td><td></td><td></td><td></td><td></td><td></td><td></td><td></td><td></td><td></td><td></td><td></td><td></td><td></td><td></td><td></td> </tr> <tr> <td>P20.10</td><td>P23.8</td><td>P23.5</td><td></td><td></td><td></td><td></td><td></td><td></td><td></td><td></td><td></td><td></td><td></td><td></td><td></td><td></td><td></td><td></td><td></td><td></td><td></td><td></td><td></td><td></td><td></td><td></td><td></td><td></td><td></td> </tr> <tr> <td>P20.13</td><td>P23.6</td><td>P23.3</td><td></td><td></td><td></td><td></td><td></td><td></td><td></td><td></td><td></td><td></td><td></td><td></td><td></td><td></td><td></td><td></td><td></td><td></td><td></td><td></td><td></td><td></td><td></td><td></td><td></td><td></td><td></td> </tr> <tr> <td>P20.14</td><td>P23.4</td><td>P23.1</td><td></td><td></td><td></td><td></td><td></td><td></td><td></td><td></td><td></td><td></td><td></td><td></td><td></td><td></td><td></td><td></td><td></td><td></td><td></td><td></td><td></td><td></td><td></td><td></td><td></td><td></td><td></td> </tr> <tr> <td>ERROROUT_Z</td><td>P23.2</td><td>P23.0</td><td></td><td></td><td></td><td></td><td></td><td></td><td></td><td></td><td></td><td></td><td></td><td></td><td></td><td></td><td></td><td></td><td></td><td></td><td></td><td></td><td></td><td></td><td></td><td></td><td></td><td></td><td></td> </tr> <tr> <td>P21.12</td><td>P20.15</td><td>P21.13</td><td></td><td></td><td></td><td></td><td></td><td></td><td></td><td></td><td></td><td></td><td></td><td></td><td></td><td></td><td></td><td></td><td></td><td></td><td></td><td></td><td></td><td></td><td></td><td></td><td></td><td></td><td></td> </tr> <tr> <td>P11.0</td><td>P10.1</td><td>P10.0</td><td></td><td></td><td></td><td></td><td></td><td></td><td></td><td></td><td></td><td></td><td></td><td></td><td></td><td></td><td></td><td></td><td></td><td></td><td></td><td></td><td></td><td></td><td></td><td></td><td></td><td></td><td></td> </tr> <tr> <td>P11.2</td><td>P10.2</td><td>P11.1</td><td></td><td></td><td></td><td></td><td></td><td></td><td></td><td></td><td></td><td></td><td></td><td></td><td></td><td></td><td></td><td></td><td></td><td></td><td></td><td></td><td></td><td></td><td></td><td></td><td></td><td></td><td></td> </tr> <tr> <td>P11.4</td><td>P10.3</td><td>P11.3</td><td></td><td></td><td></td><td></td><td></td><td></td><td></td><td></td><td></td><td></td><td></td><td></td><td></td><td></td><td></td><td></td><td></td><td></td><td></td><td></td><td></td><td></td><td></td><td></td><td></td><td></td><td></td> </tr> <tr> <td>P11.6</td><td>P10.4</td><td>P11.5</td><td></td><td></td><td></td><td></td><td></td><td></td><td></td><td></td><td></td><td></td><td></td><td></td><td></td><td></td><td></td><td></td><td></td><td></td><td></td><td></td><td></td><td></td><td></td><td></td><td></td><td></td><td></td> </tr> <tr> <td>P11.8</td><td>P10.5</td><td>P11.7</td><td></td><td></td><td></td><td></td><td></td><td></td><td></td><td></td><td></td><td></td><td></td><td></td><td></td><td></td><td></td><td></td><td></td><td></td><td></td><td></td><td></td><td></td><td></td><td></td><td></td><td></td><td></td> </tr> <tr> <td>P11.10</td><td>P10.6</td><td>P11.9</td><td></td><td></td><td></td><td></td><td></td><td></td><td></td><td></td><td></td><td></td><td></td><td></td><td></td><td></td><td></td><td></td><td></td><td></td><td></td><td></td><td></td><td></td><td></td><td></td><td></td><td></td><td></td> </tr> <tr> <td>P11.12</td><td>P10.7</td><td>P11.11</td><td></td><td></td><td></td><td></td><td></td><td></td><td></td><td></td><td></td><td></td><td></td><td></td><td></td><td></td><td></td><td></td><td></td><td></td><td></td><td></td><td></td><td></td><td></td><td></td><td></td><td></td><td></td> </tr> <tr> <td>P11.14</td><td>P10.8</td><td>P11.13</td><td></td><td></td><td></td><td></td><td></td><td></td><td></td><td></td><td></td><td></td><td></td><td></td><td></td><td></td><td></td><td></td><td></td><td></td><td></td><td></td><td></td><td></td><td></td><td></td><td></td><td></td><td></td> </tr> </table>																														1	2	3	4	5	6	7	8	9	10	11	12	13	14	15	16	17	18	19	20	21	22	23	24	25	26	27	28	29	30	P2_7	NC	DCDC.N																												P2_9	NC	DCDC.P																												P2_8	P2_10	P8_9																												P2_12	P2_14	P8_7																												P2_11	P8_10	P8_5																												P2_13	P8_8	P8_3																												P2_15	P8_6	P8_1																												P22.3	P8.4	P8.0																												P22.4	P8.2	P21.0																												P22.1	P20.1	P21.1																												P22.2	P20.3	P21.2																												P22.0	P20.5	P21.3																												P20.0	P20.7	P21.4																												P20.2	P20.9	P23.13																												P20.4	P20.12	P23.11																												P20.6	P23.12	P23.9																												P20.8	P23.10	P23.7																												P20.10	P23.8	P23.5																												P20.13	P23.6	P23.3																												P20.14	P23.4	P23.1																												ERROROUT _Z	P23.2	P23.0																												P21.12	P20.15	P21.13																												P11.0	P10.1	P10.0																												P11.2	P10.2	P11.1																												P11.4	P10.3	P11.3																												P11.6	P10.4	P11.5																												P11.8	P10.5	P11.7																												P11.10	P10.6	P11.9																												P11.12	P10.7	P11.11																												P11.14	P10.8	P11.13																											
1	2	3	4	5	6	7	8	9	10	11	12	13	14	15	16	17	18	19	20	21	22	23	24	25	26	27	28	29	30																																																																																																																																																																																																																																																																																																																																																																																																																																																																																																																																																																																																																																																																																																																																																																																																																																																																																																																																																																					
P2_7	NC	DCDC.N																																																																																																																																																																																																																																																																																																																																																																																																																																																																																																																																																																																																																																																																																																																																																																																																																																																																																																																																																																																																
P2_9	NC	DCDC.P																																																																																																																																																																																																																																																																																																																																																																																																																																																																																																																																																																																																																																																																																																																																																																																																																																																																																																																																																																																																
P2_8	P2_10	P8_9																																																																																																																																																																																																																																																																																																																																																																																																																																																																																																																																																																																																																																																																																																																																																																																																																																																																																																																																																																																																
P2_12	P2_14	P8_7																																																																																																																																																																																																																																																																																																																																																																																																																																																																																																																																																																																																																																																																																																																																																																																																																																																																																																																																																																																																
P2_11	P8_10	P8_5																																																																																																																																																																																																																																																																																																																																																																																																																																																																																																																																																																																																																																																																																																																																																																																																																																																																																																																																																																																																
P2_13	P8_8	P8_3																																																																																																																																																																																																																																																																																																																																																																																																																																																																																																																																																																																																																																																																																																																																																																																																																																																																																																																																																																																																
P2_15	P8_6	P8_1																																																																																																																																																																																																																																																																																																																																																																																																																																																																																																																																																																																																																																																																																																																																																																																																																																																																																																																																																																																																
P22.3	P8.4	P8.0																																																																																																																																																																																																																																																																																																																																																																																																																																																																																																																																																																																																																																																																																																																																																																																																																																																																																																																																																																																																
P22.4	P8.2	P21.0																																																																																																																																																																																																																																																																																																																																																																																																																																																																																																																																																																																																																																																																																																																																																																																																																																																																																																																																																																																																
P22.1	P20.1	P21.1																																																																																																																																																																																																																																																																																																																																																																																																																																																																																																																																																																																																																																																																																																																																																																																																																																																																																																																																																																																																
P22.2	P20.3	P21.2																																																																																																																																																																																																																																																																																																																																																																																																																																																																																																																																																																																																																																																																																																																																																																																																																																																																																																																																																																																																
P22.0	P20.5	P21.3																																																																																																																																																																																																																																																																																																																																																																																																																																																																																																																																																																																																																																																																																																																																																																																																																																																																																																																																																																																																
P20.0	P20.7	P21.4																																																																																																																																																																																																																																																																																																																																																																																																																																																																																																																																																																																																																																																																																																																																																																																																																																																																																																																																																																																																
P20.2	P20.9	P23.13																																																																																																																																																																																																																																																																																																																																																																																																																																																																																																																																																																																																																																																																																																																																																																																																																																																																																																																																																																																																
P20.4	P20.12	P23.11																																																																																																																																																																																																																																																																																																																																																																																																																																																																																																																																																																																																																																																																																																																																																																																																																																																																																																																																																																																																
P20.6	P23.12	P23.9																																																																																																																																																																																																																																																																																																																																																																																																																																																																																																																																																																																																																																																																																																																																																																																																																																																																																																																																																																																																
P20.8	P23.10	P23.7																																																																																																																																																																																																																																																																																																																																																																																																																																																																																																																																																																																																																																																																																																																																																																																																																																																																																																																																																																																																
P20.10	P23.8	P23.5																																																																																																																																																																																																																																																																																																																																																																																																																																																																																																																																																																																																																																																																																																																																																																																																																																																																																																																																																																																																
P20.13	P23.6	P23.3																																																																																																																																																																																																																																																																																																																																																																																																																																																																																																																																																																																																																																																																																																																																																																																																																																																																																																																																																																																																
P20.14	P23.4	P23.1																																																																																																																																																																																																																																																																																																																																																																																																																																																																																																																																																																																																																																																																																																																																																																																																																																																																																																																																																																																																
ERROROUT _Z	P23.2	P23.0																																																																																																																																																																																																																																																																																																																																																																																																																																																																																																																																																																																																																																																																																																																																																																																																																																																																																																																																																																																																
P21.12	P20.15	P21.13																																																																																																																																																																																																																																																																																																																																																																																																																																																																																																																																																																																																																																																																																																																																																																																																																																																																																																																																																																																																
P11.0	P10.1	P10.0																																																																																																																																																																																																																																																																																																																																																																																																																																																																																																																																																																																																																																																																																																																																																																																																																																																																																																																																																																																																
P11.2	P10.2	P11.1																																																																																																																																																																																																																																																																																																																																																																																																																																																																																																																																																																																																																																																																																																																																																																																																																																																																																																																																																																																																
P11.4	P10.3	P11.3																																																																																																																																																																																																																																																																																																																																																																																																																																																																																																																																																																																																																																																																																																																																																																																																																																																																																																																																																																																																
P11.6	P10.4	P11.5																																																																																																																																																																																																																																																																																																																																																																																																																																																																																																																																																																																																																																																																																																																																																																																																																																																																																																																																																																																																
P11.8	P10.5	P11.7																																																																																																																																																																																																																																																																																																																																																																																																																																																																																																																																																																																																																																																																																																																																																																																																																																																																																																																																																																																																
P11.10	P10.6	P11.9																																																																																																																																																																																																																																																																																																																																																																																																																																																																																																																																																																																																																																																																																																																																																																																																																																																																																																																																																																																																
P11.12	P10.7	P11.11																																																																																																																																																																																																																																																																																																																																																																																																																																																																																																																																																																																																																																																																																																																																																																																																																																																																																																																																																																																																
P11.14	P10.8	P11.13																																																																																																																																																																																																																																																																																																																																																																																																																																																																																																																																																																																																																																																																																																																																																																																																																																																																																																																																																																																																
			<table border="1"> <tr> <td colspan="3">CN3</td> <td colspan="3">CN4</td> <td colspan="30"></td> <td colspan="3">CN8</td> <td colspan="3">CN7</td> </tr> <tr> <td>1</td><td>2</td><td>3</td><td>4</td><td>5</td><td>6</td><td>7</td><td>8</td><td>9</td><td>10</td><td>11</td><td>12</td><td>13</td><td>14</td><td>15</td><td>16</td><td>17</td><td>18</td><td>19</td><td>20</td><td>21</td><td>22</td><td>23</td><td>24</td><td>25</td><td>26</td><td>27</td><td>28</td><td>29</td><td>30</td> </tr> <tr> <td>P19_0</td><td>P19_2</td><td>P19_4</td><td>P18_15</td><td>P18_13</td><td>P18_11</td><td>P18_9</td><td>P18_7</td><td>P18_5</td><td>P18_3</td><td>P18_1</td><td>P10_11</td><td>P10_13</td><td>P17_0</td><td>AP2_13</td><td>AP2_11</td><td>AP_2.9</td><td>AP_2.7</td><td>AP_2.5</td><td>AP_2.3</td><td>AP_2.1</td><td>AP_3.2</td><td>AP_3.5</td><td>AP_3.3</td><td>AP_3.1</td><td>AP2_14</td><td>AP2_15</td><td>AP_3.3</td><td>AP_3.1</td><td>AP2_12</td><td>AP_1.3</td><td>AP_1.2</td><td>AP_1.0</td><td>AP_0.6</td><td>NC</td><td>AP0_15</td><td>AP0_14</td> </tr> <tr> <td>P19_1</td><td>P19_3</td><td>P19_5</td><td>P18_14</td><td>P18_12</td><td>P18_10</td><td>P18_8</td><td>P18_6</td><td>P18_4</td><td>P18_3</td><td>P18_2</td><td>P10_12</td><td>P10_14</td><td>P17_1</td><td>AP2_10</td><td>AP_2.8</td><td>AP_2.6</td><td>AP_2.4</td><td>AP_2.2</td><td>AP_2.0</td><td>AP2_15</td><td>AP2_14</td><td>AP_3.3</td><td>AP_3.1</td><td>AP2_12</td><td>AP_1.3</td><td>AP_1.2</td><td>AP_1.0</td><td>AP_0.6</td><td>NC</td><td>AP0_15</td><td>AP0_14</td><td>AP_0.6</td><td>AP_0.6</td><td>AP_0.6</td><td>AP_0.6</td> </tr> <tr> <td>P11_15</td><td>P21_5</td><td>P21_6</td><td>P17_7</td><td>P17_6</td><td>P17_5</td><td>P17_4</td><td>P17_3</td><td>P17_2</td><td>P17_1</td><td>P18_1</td><td>P18_0</td><td>P18_8</td><td>P18_7</td><td>AP_2.6</td><td>AP_2.4</td><td>AP_2.2</td><td>AP_2.0</td><td>AP_1.5</td><td>AP_1.3</td><td>AP_1.1</td><td>AP_2.0</td><td>AP_3.0</td><td>AP_3.4</td><td>AP_2.2</td><td>AP_1.2</td><td>AP_1.2</td><td>AP_1.2</td><td>AP_1.2</td><td>AP_1.2</td><td>AP_1.2</td><td>AP_1.2</td><td>AP_1.2</td><td>AP_1.2</td><td>AP_1.2</td><td>AP_1.2</td> </tr> </table>																														CN3			CN4																																	CN8			CN7			1	2	3	4	5	6	7	8	9	10	11	12	13	14	15	16	17	18	19	20	21	22	23	24	25	26	27	28	29	30	P19_0	P19_2	P19_4	P18_15	P18_13	P18_11	P18_9	P18_7	P18_5	P18_3	P18_1	P10_11	P10_13	P17_0	AP2_13	AP2_11	AP_2.9	AP_2.7	AP_2.5	AP_2.3	AP_2.1	AP_3.2	AP_3.5	AP_3.3	AP_3.1	AP2_14	AP2_15	AP_3.3	AP_3.1	AP2_12	AP_1.3	AP_1.2	AP_1.0	AP_0.6	NC	AP0_15	AP0_14	P19_1	P19_3	P19_5	P18_14	P18_12	P18_10	P18_8	P18_6	P18_4	P18_3	P18_2	P10_12	P10_14	P17_1	AP2_10	AP_2.8	AP_2.6	AP_2.4	AP_2.2	AP_2.0	AP2_15	AP2_14	AP_3.3	AP_3.1	AP2_12	AP_1.3	AP_1.2	AP_1.0	AP_0.6	NC	AP0_15	AP0_14	AP_0.6	AP_0.6	AP_0.6	AP_0.6	P11_15	P21_5	P21_6	P17_7	P17_6	P17_5	P17_4	P17_3	P17_2	P17_1	P18_1	P18_0	P18_8	P18_7	AP_2.6	AP_2.4	AP_2.2	AP_2.0	AP_1.5	AP_1.3	AP_1.1	AP_2.0	AP_3.0	AP_3.4	AP_2.2	AP_1.2	AP_1.2	AP_1.2	AP_1.2	AP_1.2	AP_1.2	AP_1.2	AP_1.2	AP_1.2	AP_1.2	AP_1.2																																																																																																																																																																																																																																																																																																																																																																																																																																																																																																																																																																																																																																																																																																																																																																													
CN3			CN4																																	CN8			CN7																																																																																																																																																																																																																																																																																																																																																																																																																																																																																																																																																																																																																																																																																																																																																																																																																																																																																																																																																											
1	2	3	4	5	6	7	8	9	10	11	12	13	14	15	16	17	18	19	20	21	22	23	24	25	26	27	28	29	30																																																																																																																																																																																																																																																																																																																																																																																																																																																																																																																																																																																																																																																																																																																																																																																																																																																																																																																																																																					
P19_0	P19_2	P19_4	P18_15	P18_13	P18_11	P18_9	P18_7	P18_5	P18_3	P18_1	P10_11	P10_13	P17_0	AP2_13	AP2_11	AP_2.9	AP_2.7	AP_2.5	AP_2.3	AP_2.1	AP_3.2	AP_3.5	AP_3.3	AP_3.1	AP2_14	AP2_15	AP_3.3	AP_3.1	AP2_12	AP_1.3	AP_1.2	AP_1.0	AP_0.6	NC	AP0_15	AP0_14																																																																																																																																																																																																																																																																																																																																																																																																																																																																																																																																																																																																																																																																																																																																																																																																																																																																																																																																																														
P19_1	P19_3	P19_5	P18_14	P18_12	P18_10	P18_8	P18_6	P18_4	P18_3	P18_2	P10_12	P10_14	P17_1	AP2_10	AP_2.8	AP_2.6	AP_2.4	AP_2.2	AP_2.0	AP2_15	AP2_14	AP_3.3	AP_3.1	AP2_12	AP_1.3	AP_1.2	AP_1.0	AP_0.6	NC	AP0_15	AP0_14	AP_0.6	AP_0.6	AP_0.6	AP_0.6																																																																																																																																																																																																																																																																																																																																																																																																																																																																																																																																																																																																																																																																																																																																																																																																																																																																																																																																																															
P11_15	P21_5	P21_6	P17_7	P17_6	P17_5	P17_4	P17_3	P17_2	P17_1	P18_1	P18_0	P18_8	P18_7	AP_2.6	AP_2.4	AP_2.2	AP_2.0	AP_1.5	AP_1.3	AP_1.1	AP_2.0	AP_3.0	AP_3.4	AP_2.2	AP_1.2	AP_1.2	AP_1.2	AP_1.2	AP_1.2	AP_1.2	AP_1.2	AP_1.2	AP_1.2	AP_1.2	AP_1.2																																																																																																																																																																																																																																																																																																																																																																																																																																																																																																																																																																																																																																																																																																																																																																																																																																																																																																																																																															

Figure 2-4 Assignment of Pin Headers

2.3 34-Pin to 14-Pin Conversion Adapter (RTE0T00020KCA30000J)

The conversion adapter is an adapter board that is used to connect an emulator with a 14-pin connector to the emulation adapter and is required for debugging in such situations.

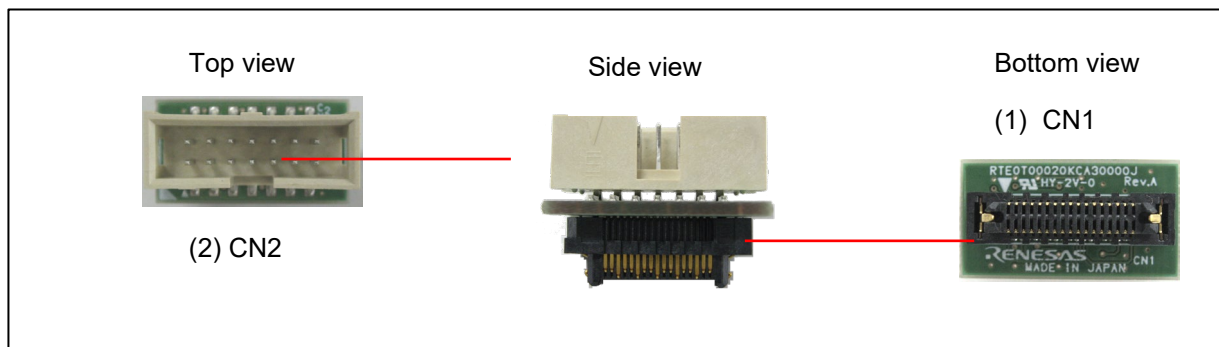

Figure 2-5 Names of the Parts of the 34-Pin to 14-Pin Conversion Adapter (RTE0T00020KCA30000J)

(1) Connector: CN1 (34-pin side)

CN1 can be connected to CN1 for external tracing through the emulation adapter.

(2) Connector: CN2 (14-pin side)

CN2 is a 14-pin connector that is defined as a connector for the RH850 emulators. This connector can be connected to on-chip debugging emulators such as the E2 emulator (type name: RTE0T00020KCE00000R) from Renesas and flash programmers that support the 14-pin connector.

The following shows pin assignments of CN2. Read the user's manual for the emulator you will be using and connect the emulator with this connector.

Table 2-2 Pin Assignments of the 14-Pin Connector (CN2)

Signal Name	Pin No.	Pin No.	Signal Name
TCK/LPDCLK	1	2	GND
TRST	3	4	FPMD0 (FLMD0)
TDO/LPDO	5	6	FPMD1 (FLMD1)
TDI/LPDIO	7	8	TVDD (E0VCC)
TMS	9	10	EVTO
DRDY/LPDCLKO	11	12	GND
RESET	13	14	GND

2.4 Power-Supply Cable

The power-supply cable (about 300-mm long) supplies power to the emulation adapter.

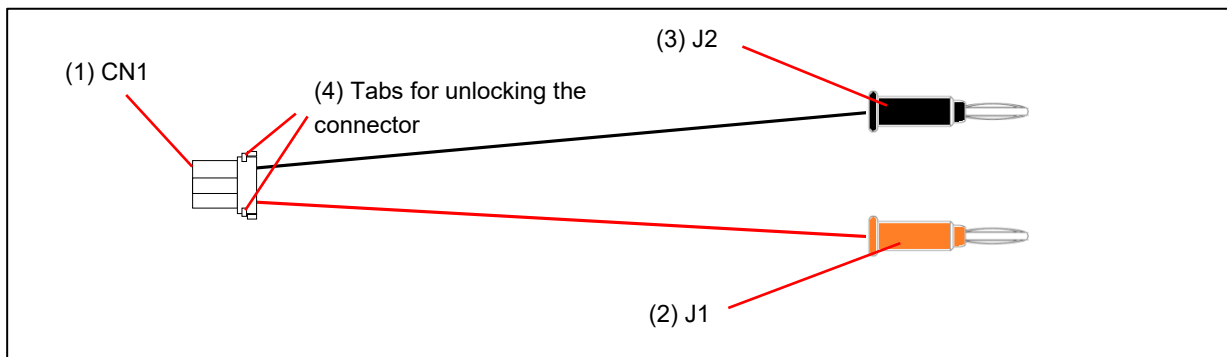

Figure 2-6 Names of the Parts of the Power-Supply Cable

(1) Connector: CN1

CN1 is a connector (LEAR-02V-S from JST) for connection to CN2 of the emulation adapter.

(2) Power jack: J1 (red)

Supply 5 V from a stabilized power supply.

(3) Power jack: J2 (black)

Connect J2 to GND.

(4) Tabs for unlocking the connector

When disconnecting the power-supply cable from the emulation adapter, press the tabs on both sides of the CN1 connector of the power-supply cable to unlock the connector.

CAUTION

Unlocking the connector:



Do not press the tabs for unlocking the connector too hard as this may lead to them being stuck in this position. Take care on this point.

2.5 Demounting Lever

The demounting lever which comes with this product is used to remove the emulation adapter from the base board or exchange adapter.

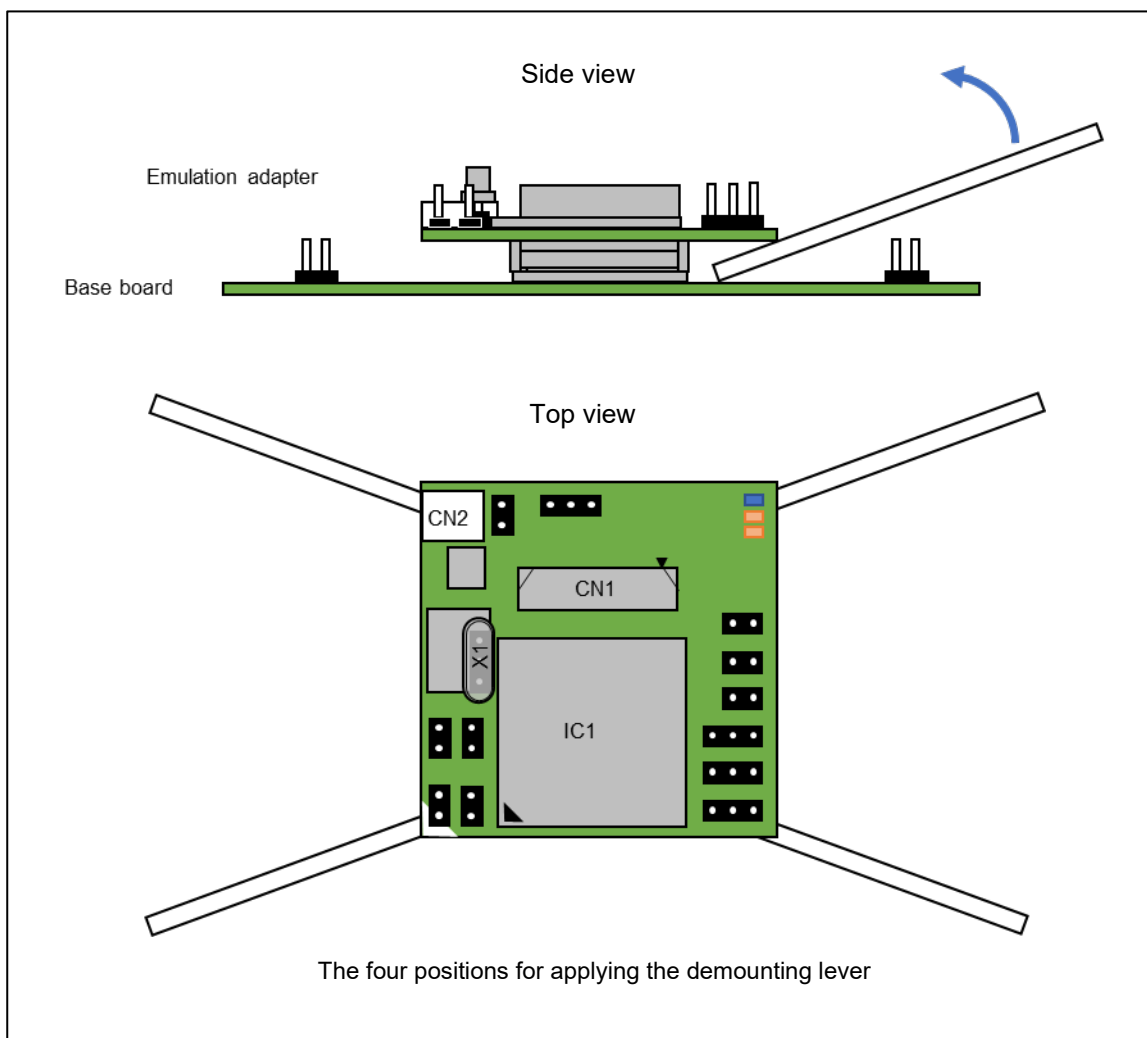



Figure 2-7 Demounting Lever

To remove the emulation adapter from the base board or exchange adapter, insert the demounting lever alternately below all four corners of the emulation adapter and gradually pull the emulation adapter out.

 CAUTION	
Point for caution on removing the emulation adapter:	
	When you remove the emulation adapter from the base board or exchange adapter, take care not to damage or deform peripheral components.

3. System Configuration and Setup

The system configurations of this emulation adapter are as follows according to your intentions in using it.

- A simple evaluation board (See section 3.1.)
- An emulation board (See section 3.2.)

3.1 System Configuration as a Simple Evaluation Board

Figure 3-1 shows a system configuration when the emulation adapter is connected to the base board for use as a simple evaluation board. Connection of an emulator is not essential.

Using the pin headers on the base board enables the control and monitoring of each pin of the target device.

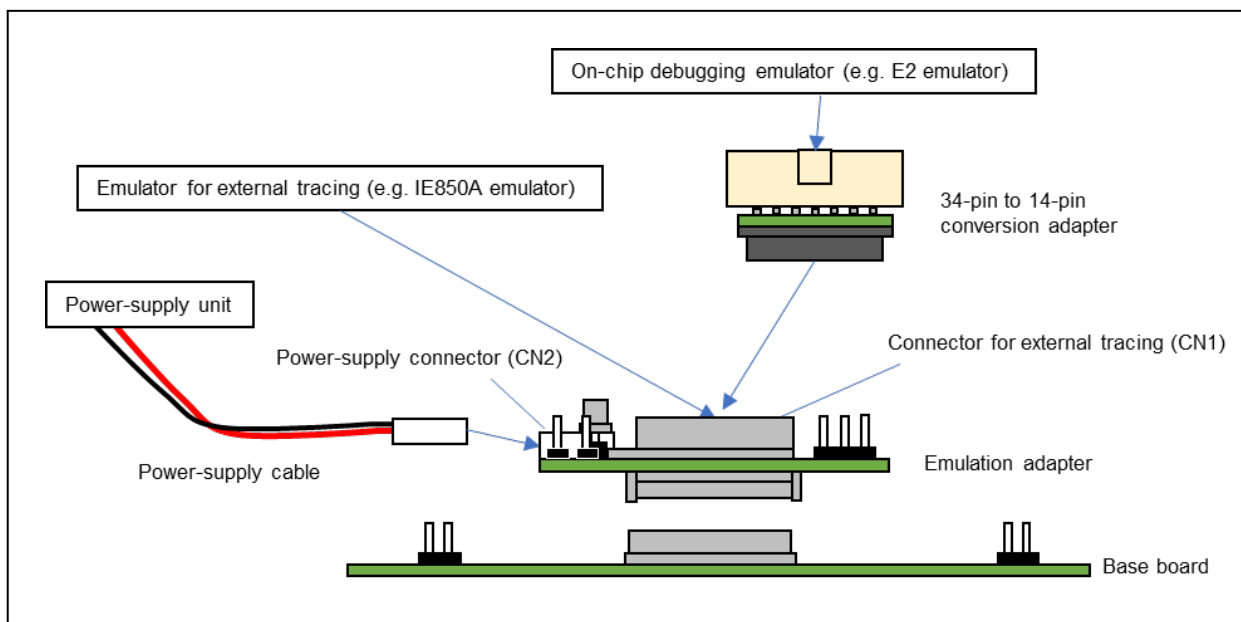

Figure 3-1 System Configuration (Simple Evaluation Board)

3.1.1 Settings for Use as a Simple Evaluation Board

Table 3-1 and Table 3-2 show lists of the recommended settings for this system configuration. For details on the items, refer to chapter 2.

Table 3-1 Recommended Settings for Use as a Simple Evaluation Board (Emulation Adapter)

Item	Description
Debug chip: IC1	Set an option byte. Refer to section 4.1.
Connector for external tracing: CN1	When an emulator is in use: Connect the cable for the emulator or the 34-pin to 14-pin conversion adapter.
	When an emulator is not in use: Leave the connector open-circuit.
Power-supply connector: CN2	Set up a +5-V supply through the attached power-supply cable. If you are using the IE850A, power can be supplied from the power-supply cable attached to the IE850A.
Clock socket: X1	A resonator is mounted (40 MHz as shipped). When you are evaluating the emulation adapter with a different frequency or with a crystal oscillator as the main oscillator, change the resonator or exchange it for an oscillator.
Jumper block: JP5 (ISOVDD_SEL)	1-2 short-circuit (default)
Jumper block: JP10 (ERAMRES)	Short-circuit (default)
Jumper block: JP9 (AUORES)	Short-circuit (default)
Jumper block: JP3 (ExVCC)	Short-circuit (default)
Jumper block: JP2 (FLMD0)	1-2 short-circuit (default)
Jumper block: JP11 (FLMD1)	2-3 short-circuit (default)
Jumper block: JP4 (ExVDD)	1-2 short-circuit (default)
Jumper block: JP1 (VDD_EMU)	Short-circuit (default)
Jumper block: JP7 (DVDD)	Short-circuit (default)
Jumper block: JP6 (EMUVDD)	Short-circuit (default)
Jumper block: JP8 (ERAMVDD)	Short-circuit (default)
Interfaces for the exchange adapter: CN10, CN11, CN12, and CN13	Connect these connectors to the base board.

Table 3-2 Recommended Settings for Use as a Simple Evaluation Board (Base Board)

Item	Description
Interfaces for the exchange adapter: CN10, CN11, CN12, and CN13	Connect these connectors to the emulation adapter.
Switch: SW1 (POWER SW)	Refer to (2) in section 2.2.
Switch: SW2 (RESET SW)	Refer to (3) in section 2.2.
Jumper blocks: JP1 to JP17 (selecting each of the power-supply voltages)	The voltage of each power supply is selected according to the conditions to be evaluated or the specifications of the target device. Refer to (5) in section 2.2.
Jumper block: JP18 (FLMD0)	Open-circuit (default)

3.1.2 Procedure for Setting the Emulation Adapter up as a Simple Evaluation Board

This section describes the procedure for setting the emulation adapter up for use as a simple evaluation board.

(1) Settings on the boards

Make settings for the emulation adapter and base board according to the statements in section 3.1.1. Turn off the SW1 switch (POWER SW) on the base board and set the SW2 switch (RESET SW) for the low level.

(2) Connecting the power-supply cable

Connect the power-supply cable which comes with this product to the CN2 power-supply connector of the emulation adapter then connect a power-supply unit such as a stabilized power supply. Do not turn the power on.



If you are using an IE850A emulator, power can be supplied by connecting the power-supply cable attached to the IE850A.

(3) Connecting the emulation adapter to the base board

Connect the two boards so that the sticker and silk-screened mark for aligning the positions of pin 1 of the emulation adapter and base board are in the same position.

(4) Connecting the emulator (only if you are using an emulator)

Connect the emulator to the CN1 connector for external tracing from the emulation adapter. If you are using an emulator (e.g. an IE850A) that supports external tracing (Aurora tracing), directly connect the emulator cable. If you are using an emulator (e.g. an E2) that supports a 14-pin connector, connect the emulator via the 32-pin to 14-pin conversion adapter.

 CAUTION	
Connecting the emulator:	
	Confirm the direction with the notch on the connector and connect the emulator while taking care that the direction of insertion is correct.

(5) Turning on the emulator (only if you are using an emulator)

Turn on the emulator. For details, refer to the manuals for the emulator you are using.

(6) Turning on the emulation adapter and base board and release from reset

Output 5 V from the power-supply unit that is connected to the power-supply connector (CN2) of the emulation adapter. When the IE850A is connected to CN2, output 5 V by turning on the emulator as described in step (5) above. Then, turn the switch (SW1; POWER SW) of the base board on and set SW2 (RESET SW) for the high level.

Accordingly, if an emulator is not connected, the debug chip will start executing a program.

When the emulator is connected, the debug chip will be kept in the reset state before execution of a program is started by the debugger after the debugger has been launched, although this depends on the specifications of the emulator.

 **CAUTION**

Applied voltage:



Make sure that the voltage applied to CN2 is within the specified range (4.5 V to 5.5 V).
An applied voltage out of the range may cause the emulation adapter to emit smoke or catch fire or otherwise be damaged.

(7) Launching the debugger (only if you are using an emulator)

Launch the debugger to start debugging. The first time this is done, an option byte must be set according to the target device to be emulated.

3.1.3 Procedure for Closing a Session of Use as a Simple Evaluation Board

This section describes the procedure for closing a session of using the emulation adapter as a simple evaluation board.

(1) Closing the debugger (only if you are using an emulator)

Close the debugger.

(2) Turning off and resetting the emulation adapter and base board

Set SW2 (RESET SW) of the base board for the low level. Turn the switch (SW1; POWER SW) of the base board off. Turn off the output from the power-supply unit that is connected to the power-supply connector (CN2) of the emulation adapter. When the IE850A is connected to CN2, turn off the emulation adapter and base board by turning off the emulator as described in step (3) below.

(3) Turning off the emulator (only if you are using an emulator)

Turn off the emulator. For details, refer to manuals for the emulator you are using.

Take the steps below as required.

(4) Disconnecting the emulator (only if you are using an emulator)

Disconnect the emulator from the emulation adapter.

(5) Disconnecting the emulation adapter from the base board

To disconnect the emulation adapter from the base board, insert the demounting lever which comes with this product into alternate corners among the four corners between the two boards and gradually pull the emulation adapter out. Take care of the positions where you insert the demounting lever so that you do not accidentally tear off components on the boards. For details, refer to section 2.5.

(6) Disconnecting the power-supply cable

Disconnect the power-supply cable from the CN2 power-supply connector of the emulation adapter. When disconnecting the power-supply cable from the emulation adapter, press the tabs on both sides of the CN1 connector of the power-supply cable to unlock the connector.

CAUTION

Unlocking the connector:



Do not press the tabs for unlocking the connector too hard as this may lead to them being stuck in this position. Take care on this point.

3.2 System Configuration as an Emulation Board

Figure 3-2 shows a system configuration when the emulation adapter is to be connected to the exchange adapter then connected to a target board (the base board is not used). For the specifications of the exchange adapters, refer to appendix A, Specifications of the Exchange Adapters.

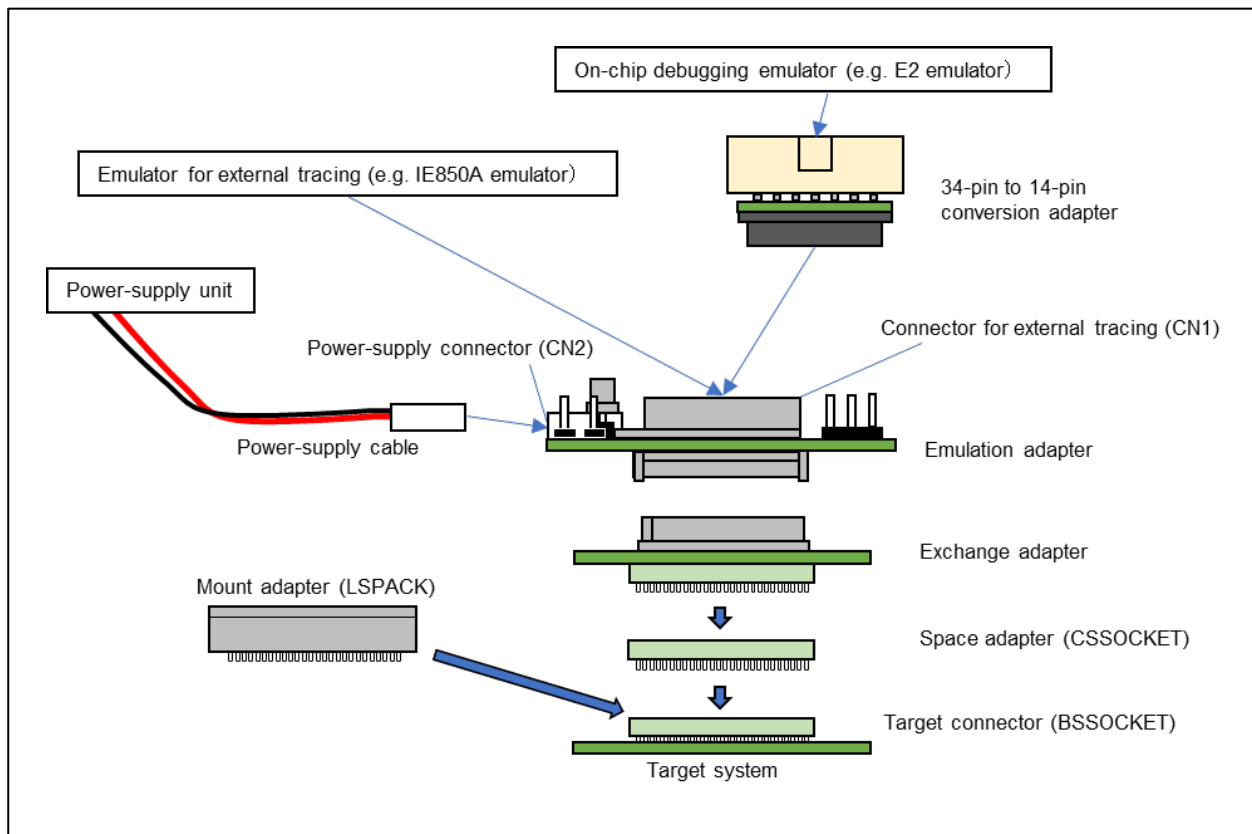

Figure 3-2 System Configuration (Emulation Board)

3.2.1 Settings for Use as an Emulation Board

Table 3-3 and Table 3-4 show lists of the recommended settings of the emulation adapter for this system configuration. For the settings when the power is supplied from CN2, refer to Table 3-3. If the power is not supplied from CN2, the settings in Table 3-4 are also required. When you select a configuration in which the power is not supplied from CN2, note that neither ERAM nor external tracing (Aurora tracing) is available.

Table 3-3 Recommended Settings for Use as an Emulation Board when the Power is to be Supplied from CN2

Item	Description
Debug chip: IC1	Set an option byte. Refer to section 4.1.
Connector for external tracing: CN1	When an emulator is in use: Connect the cable for the emulator or the 34-pin to 14-pin conversion adapter.
	When an emulator is not in use: Leave the connector open-circuit.
Power-supply connector: CN2	Set up a +5-V supply through the attached power-supply cable. If you are using the IE850A, power can be supplied from the power-supply cable attached to the IE850A.
Clock socket: X1	A resonator is mounted (40 MHz as shipped). When you are evaluating the emulation adapter with a different frequency or with a crystal oscillator as the main oscillator, change the resonator or exchange it for an oscillator.
Jumper block: JP5 (ISOVDD_SEL)	1-2 short-circuit (default)
Jumper block: JP10 (ERAMRES)	Short-circuit (default)
Jumper block: JP9 (AURORES)	Short-circuit (default)
Jumper block: JP3 (ExVCC)	Short-circuit (default)
Jumper block: JP2 (FLMD0)	1-2 short-circuit (default)
Jumper block: JP11 (FLMD1)	2-3 short-circuit (default)
Jumper block: JP4 (ExVDD)	1-2 short-circuit (default)
Jumper block: JP1 (VDD_EMU)	Short-circuit (default)
Jumper block: JP7 (DVDD)	Short-circuit (default)
Jumper block: JP6 (EMUVDD)	Short-circuit (default)
Jumper block: JP8 (ERAMVDD)	Short-circuit (default)
Interfaces for the exchange adapter: CN10, CN11, CN12, and CN13	Connect these connectors to the base board.

Table 3-4 Recommended Settings for Use as an Emulation Board when the Power is not to be Supplied from CN2

Item	Description
Debug chip: IC1	Set an option byte. Refer to section 4.1.
Connector for external tracing: CN1	When an emulator is in use: Connect the cable for the emulator or the 34-pin to 14-pin conversion adapter.
	When an emulator is not in use: Leave the connector open-circuit.
Power-supply connector: CN2	Leave the connector open-circuit.
Clock socket: X1	A resonator is mounted (40 MHz as shipped). When you are evaluating the emulation adapter with a different frequency or with a crystal oscillator as the main oscillator, change the resonator or exchange it for an oscillator.
Jumper block: JP5 (ISOVDD_SEL)	2-3 short-circuit
Jumper block: JP10 (ERAMRES)	Open-circuit
Jumper block: JP9 (AUORES)	Open-circuit
Jumper block: JP3 (ExVCC)	Open-circuit
Jumper block: JP2 (FLMD0)	1-2 short-circuit (default)
Jumper block: JP11 (FLMD1)	2-3 short-circuit (default)
Jumper block: JP4 (ExVDD)	1-2 short-circuit (default)
Jumper block: JP1 (VDD_EMU)	Open-circuit
Jumper block: JP7 (DVDD)	Open-circuit
Jumper block: JP6 (EMUVDD)	Open-circuit
Jumper block: JP8 (ERAMVDD)	Open-circuit
Interfaces for the exchange adapter: CN10, CN11, CN12, and CN13	Connect these connectors to the base board.

3.2.2 Procedure for Setting the Emulation Adapter up as an Emulation Board

This section describes the procedure for setting the emulation adapter up for use as an emulation board.

(1) Settings on the boards

Make settings for the emulation adapter according to the statements in section 3.2.1.

(2) Connecting the power-supply cable (when the power is supplied from CN2)

Connect the power-supply cable which comes with this product to the CN2 power-supply connector of the emulation adapter then connect a power-supply unit such as a stabilized power supply. Do not turn the power on.

If you are using an IE850A emulator, power can be supplied by connecting the power-supply cable attached to the IE850A.



(3) Connecting the emulation adapter to the exchange adapter

Connect the two boards so that the positions of pin 1 of the emulation adapter and of the exchange adapter are in the same position.

(4) Connecting the exchange adapter to the target system



The target connector (BSSOCKET) must be mounted on the pad pattern for the target device of the target system in advance.

After that, connect the exchange adapter to the target connector mounted on the target system.

 CAUTION	
Connecting the exchange adapter:	
	Connect the exchange adapter to the target system by aligning the positions of pin 1 of the target connector and of the exchange adapter and confirming that the contact pins of the exchange adapter are not bent.

(5) Connecting the emulator (only if you are using an emulator)

Connect the emulator to the CN1 connector for external tracing from the emulation adapter. If you are using an emulator (e.g. an IE850A) that supports external tracing (Aurora tracing), directly connect the emulator cable. If you are using an emulator (e.g. an E2) that supports a 14-pin connector, connect the emulator via the 32-pin to 14-pin conversion adapter.



 CAUTION	
Connecting the emulator:	
	Confirm the direction with the notch on the connector and connect the emulator while taking care that the direction of insertion is correct.

(6) Turning on the emulator (only if you are using an emulator)

Turn on the emulator. For details, refer to the manuals for the emulator you are using.

(7) Turning on the emulation adapter

Output 5 V from the power-supply unit that is connected to the power-supply connector (CN2) of the emulation adapter. When the IE850A is connected to CN2, output 5 V by turning on the emulator as described in step (6) above.

 CAUTION	
Applied voltage:	
	Make sure that the voltage applied to CN2 is within the specified range (4.5 V to 5.5 V). An applied voltage out of the range may cause the emulation adapter to emit smoke or catch fire or otherwise be damaged.

(8) Turning on the target system

Turn on the target system.

(9) Launching the debugger (only if you are using an emulator)

Launch the debugger to start debugging. The first time this is done, an option byte must be set according to the target device to be emulated.

3.2.3 Procedure for Closing a Session of Use as an Emulation Board

This section describes the procedure for closing a session of using the emulation adapter as an emulation board.

(1) Closing the debugger (only if you are using an emulator)

Close the debugger.

(2) Turning off the target system

Turn off the target system.

(3) Turning off the emulation adapter

Stop the 5-V output from the power-supply unit that is connected to the power-supply connector (CN2) of the emulation adapter. When the IE850A is connected to CN2, turn off the emulation adapter by turning off the emulator as described in step (4) below.

(4) Turning off the emulator (only if you are using an emulator)

Turn off the emulator. For details, refer to manuals for the emulator you are using.

Take the steps below as required.

(5) Disconnecting the emulator (only if you are using an emulator)

Disconnect the emulator from the emulation adapter.

(6) Disconnecting the emulation adapter from the exchange adapter

To disconnect the emulation adapter from the exchange adapter, insert the demounting lever which comes with this product into alternate corners among the four corners between the two boards and gradually pull the emulation adapter out. Take care of the positions where you insert the demounting lever so that you do not accidentally tear off components on the boards. For details, refer to section 2.5.

(7) Disconnecting the exchange adapter from the target system

Disconnect the exchange adapter from the target system.

For details, refer to appendix A, Specifications of the Exchange Adapters.

(8) Disconnecting the power-supply cable (when the power is supplied from CN2)

Disconnect the power-supply cable from the CN2 power-supply connector of the emulation adapter. When disconnecting the power-supply cable from the emulation adapter, press the tabs on both sides of the CN1 connector of the power-supply cable to unlock the connector.

 **CAUTION**

Unlocking the connector:



Do not press the tabs for unlocking the connector too hard as this may lead to them being stuck in this position. Take care on this point.

4. Notes

4.1 Setting Option Bytes

Although the specifications of the option bytes of the debug chip which is mounted on the emulation adapter are the same as those of the target device, the actual settings at the time of shipment may differ.

Use a debugger or flash programmer to specify appropriate values for the option bytes of the debug chip according to the user's manual for the target device.

In particular, the values of the following option bytes must be specified to suit the device to be emulated.

4.1.1 OPBT9 (EVA_PRD_EMU)

The OPBT9[0] (EVA_PRD_EMU) bit must be set according to the target for emulation.

OPBT9[0] = 0: Emulation in U2A8 mode

OPBT9[0] = 1: Emulation in U2A16 mode (default)

When switching emulation among the U2A6, U2A8, and U2A16 devices, set the switches of the exchange adapter (RTE7702300CBG292T000J).

4.1.2 OPBT3 (PEX_DISABLE)

OPBT3 defines the CPUs which are to be enabled. Since the debug chip has four CPUs, disable the unnecessary CPUs (set the PEX_DISABLE bit to 1) through the setting of OPBT3 according to the number of CPUs in the device to be emulated.

4.1.3 OPBT16 (SVRENABLE)

When pins 1-2 of JP5 are short-circuited (default) so that VDD which has been generated by the power-supply IC on the emulation adapter is supplied to the debug chip, set OPBT16[31] (SVRENABLE) to 0 to disable the switching voltage regulator (SVR).

4.2 Notes on Differences between the Actual Device and the Emulation Adapter

4.2.1 Current Drawn

When the emulation adapter is in use, current drawn may differ from that for the actual device. Thus, the customer should use the actual device in a final evaluation before mass production and judge the suitability of adopting the product on that basis.

4.2.2 Oscillator

The emulation adapter does not support clock input from an oscillator on the target system. The main clock oscillator on the emulation adapter is used as the main clock.

Proceed with final evaluation to confirm operation of the target system after mounting the actual device and while using the oscillator on the target system.

4.2.3 Power-Supply Voltages

The debug chip mounted on the emulation adapter basically operates with the power supplied from the target system. However, note that there are differences in the following power-supply voltages.

- EMUVDD, DVDD, ERAMVDD, EMUVCC, DVCC, and EMUVCC are generated on the emulation adapter.
- Whether the power-supply voltage generated on the emulation adapter or that for the target system is used for VDD is selectable by the setting of JP5 on the emulation adapter.

When you use the power supply from the target system, note that transient drops in the power-supply voltage may occur.

4.2.4 VSS Pins for Each Power-Supply Voltage

AxVSS, SVRAVSS, SVRDRVSS, and VSS are connected to a common GND in the emulation adapter.

4.2.5 AWOVCL and GETH0VCL Pins

Stabilizing capacitors are connected to the stabilizing capacitor connection pins (AWOVCL and GETH0VCL) on the emulation adapter. These pins are not connected on the target system.

4.2.6 A/D Converter

Results from the A/D converter may differ from those on the actual device because of the exchange adaptor etc. between the debug chip and the target system.

4.2.7 Emulation of the SVR

The emulation adapter mounts the power-supply IC which is used to generate VDD for the debug chip. When VDD that has been generated in the SVR circuit on the user system is to be supplied to the debug chip, short-circuit pins 2-3 of jumper block JP5. Since DCDC_P and DCDC_N signals are supplied through the exchange adapter and the characteristics of these signals will differ from those of the signals when the actual device is connected, reviewing the SVR parameters may be required or operation of the SVR circuit may not be correct.

4.2.8 Emulation of the Ethernet AVB (SGMII)

The debug chip on the emulation adapter cannot emulate the Serial Gigabit Media Independent Interface (SGMII).

4.2.9 Power Supply of the P3_8 Pin

The power supply of the P3_8 pin of the debug chip is GETH0RVCC regardless of whether the SGMII is or is not to be used. When the emulation adapter is in use with the base board, the setting of a jumper block (TGETH0RVCC) on the base board determines the power supply of the P3_8 pin.

4.3 Note on Debugging

4.3.1 Enabling C&R Authentication

If the ICU-M core of the debug chip on the emulation adapter is enabled and C&R authentication of the debug chip is enabled for a program that fails C&R authentication, note that starting the debugger and disabling C&R authentication will not be possible.

5. Characteristics of Target Interface

The target interface behaves as if the actual device is connected in terms of functionality. However, in terms of characteristics, the behavior of the target interface sometimes differs from the behavior when the actual device is connected. Figure 5-1 shows an equivalent circuit of this product.

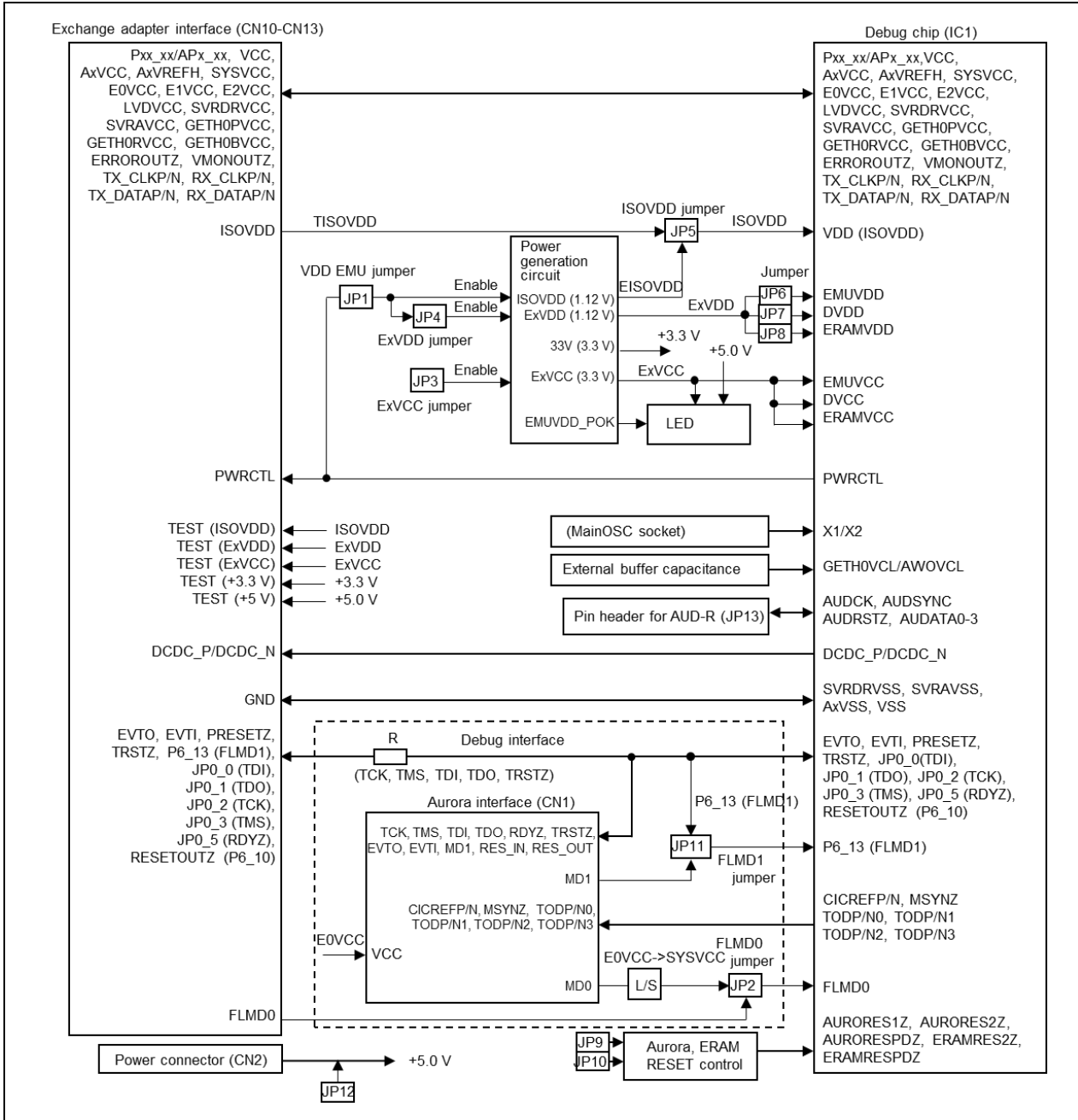

Figure 5-1 Equivalent Circuit of the Emulation Adapter

6. Maintenance and Warranty

This chapter covers basic maintenance, warranty information, provisions for repair and the procedures for requesting a repair. For information on the exchange adapter and socket products, refer to appendix A, Specifications of the Exchange Adapters.

6.1 Maintenance

- (1) If dust or dirt collects on this product, wipe it off with a dry soft cloth. Do not use thinner or other solvents because these chemicals can cause the surface coating to separate.
- (2) When you do not use this product for a long period, disconnect it from the power supply, host machine, and target system.

6.2 Warranty

- (1) This product comes with a one-year warranty after purchase.
Should the product break down or be damaged while you're using it under normal conditions in accord with its user's manual, it will be repaired or replaced free of cost.
- (2) However, if the following types of failure or damage to the product occur during the term of the warranty, repairing or replacing the product will incur a cost.
 - a) Failure or damage attributable to the misuse or abuse of the product or its use under other abnormal conditions.
 - b) Failure or damage attributable to improper handling of the product after purchase, such as dropping the product while it is being transported or otherwise moved.
 - c) Failure or damage to the product caused by other pieces of equipment connected to it.
 - d) Failure or damage attributable to fire, earthquakes, thunderbolts, floods, or other natural disasters, or to abnormal voltages, etc.
 - e) Failure or damage attributable to modifications, repairs, adjustments, or other acts in relation to the product by parties other than Renesas Electronics Corp.
- (3) Consumables (e.g., sockets and adaptors) are beyond the scope of repair and replacement.

In the above cases, contact your local distributor. If you are renting the product, consult the company you are renting it from or the owner.

6.3 Repair Provisions

- (1) Repairs not covered by warranty
Problems arising in products for which more than one year has elapsed since purchase are not covered by warranty.
- (2) Replacement not covered by warranty
If your product's fault falls into any of the following categories, the fault will be corrected by replacing the entire product instead of repairing it, or you will be advised to purchase a new product, depending on the severity of the fault.
 - Faulty or broken mechanical portions
 - Flaws, separation, or rust in coated or plated portions
 - Flaws or cracks in plastic portions
 - Faults or breakage caused by improper use or unauthorized repair or modification
 - Heavily damaged electric circuits due to overvoltage, overcurrent or shorting of power supply

- Cracks in the printed circuit board or burnt-down patterns
 - A wide range of faults that make replacement less expensive than repair
 - Faults that are not locatable or identifiable
- (3) Expiration of the repair period
- We accept requests for repairs up to three years after production of a given model has ceased.
 - Repairing a given model may become impossible even during the above period if the parts required for the repairs are no longer available.
- (4) Carriage fees for sending your product to be repaired
- Carriage fees for sending your product to us for repair are at your own expense.

6.4 How to Request Repairs

If your product is found faulty, fill in a Repair Request Sheet downloadable from the following URL and email the sheet and send the product to your local distributor.

<http://www.renesas.com/repair>

CAUTION

Note on Transporting the Product:



When sending your product for repair, use the packing box and cushioning material supplied with the MCU unit when it was delivered to you and specify caution in handling (handling as precision equipment). If packing of your product is not complete, it may be damaged during transportation. When you pack your product in a bag, make sure to use the conductive plastic bag supplied with the MCU unit (usually a blue bag). If you use a different bag, it may lead to further trouble with your product due to static electricity.

Appendix A Specifications of the Exchange Adapters

(1) Overview

An exchange adapter is an adapter board that connects the emulation adapter to the pad pattern for the target device. It is sold separately from this product.

The following describes the specifications of the RTE7702200CBG516T000J exchange adapter for the 516-pin BGA package, the RTE7702300CBG373T000J exchange adapter for the 373-pin BGA package, and the RTE7702300CBG292T000J exchange adapter for the 292-pin BGA package.

(2) List of Packages and Sockets

Table A-1 lists the exchange adapters and type names of sockets for the packages of the target devices. The BSSOCKET target connector, CSSOCKET space adapter, and LSPACK mount adapter of the BGA package can be purchased from Tokyo Eletech Corporation. The exchange adapters can be purchased from Renesas Electronics Corporation. If you particularly require details on the CSSOCKET space adapter, contact Tokyo Eletech Corporation.

Table A-1 Packages, Exchange Adapters, and Sockets

Package Device	Exchange Adapter	Target Connector	Space Adapter	Mount Adapter
FBGA-516 0.8-mm ball pitch RH850/U2A	RTE7702200CBG516T000J	BSSOCKET516A3025RE21N	CSSOCKET516A3025RE03 CSSOCKET516A3025RE04	LSPACK516A3025RE01
FBGA-373 0.8-mm ball pitch RH850/U2A	RTE7702300CBG373T000J	BSSOCKET373A2521RE21N	CSSOCKET373A2521RE03 CSSOCKET373A2521RE04	LSPACK373A2521RE01
FBGA-292 0.8-mm ball pitch RH850/U2A	RTE7702300CBG292T000J	BSSOCKET292A2017RE22N	CSSOCKET292A2017RE23 CSSOCKET292A2017RE24	LSPACK292A2017RE21

BSSOCKET target connector (required for emulation):

This connector is for mounting on the target system.

Exchange adapter (required for emulation):

This conversion adapter is for connecting the emulation adapter to the target connector.

CSSOCKET space adapter (optional):

This adapter is used to adjust the height. It is an optional product which is available for use if the components around the target connector would otherwise touch the exchange adapter or emulation adapter.



LSPACK mount adapter (optional):

When the target device is mounted on the target connector, this adapter is required as a cover.

(3) Number of insertions and removals of the connector

The connector is guaranteed for correct insertion and removal 100 times.

(4) Settings (only for the RTE7702300CBG292T000J)

SW1 and SW2	Specification
 <p>U2A6 ↕ U2A8 U2A16</p>	<p>This setting is made for emulating the RH850/U2A6.</p>
 <p>U2A6 ↕ U2A8 U2A16</p>	<p>This setting is made for emulating the RH850/U2A8 and U2A16.</p>

(5) How to use the emulation adapter

The emulation adapter can be connected to the target system via the exchange adapter through the following procedure. Align the positions of pin 1 as shown in Figure A-1.

1. Mount the target connector (BSSOCKET) on the target system.
2. If you are using the RTE7702300CBG292T000J exchange adapter, set SW1 and SW2 according to the setting whether the device to be emulated is the U2A6, U2A8, or U2A16.
3. Connect the exchange adapter to the emulation adapter.
4. Connect the exchange adapter to the target connector (BSSOCKET).
 - If adjustment of the height is required, use the space adapter (CSSOCKET).
 - Confirm that the contact pins are not bent.

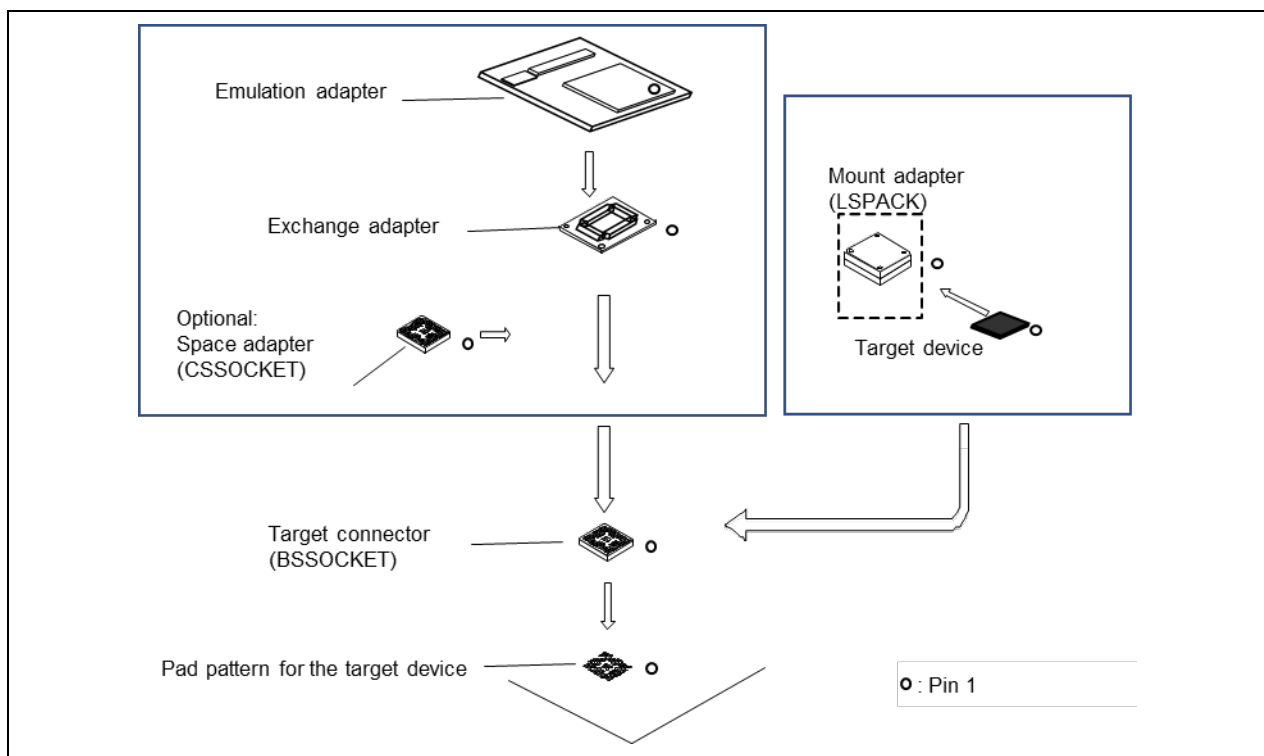

Figure A-1 Connecting the Emulation Adapter

(6) Dimensions

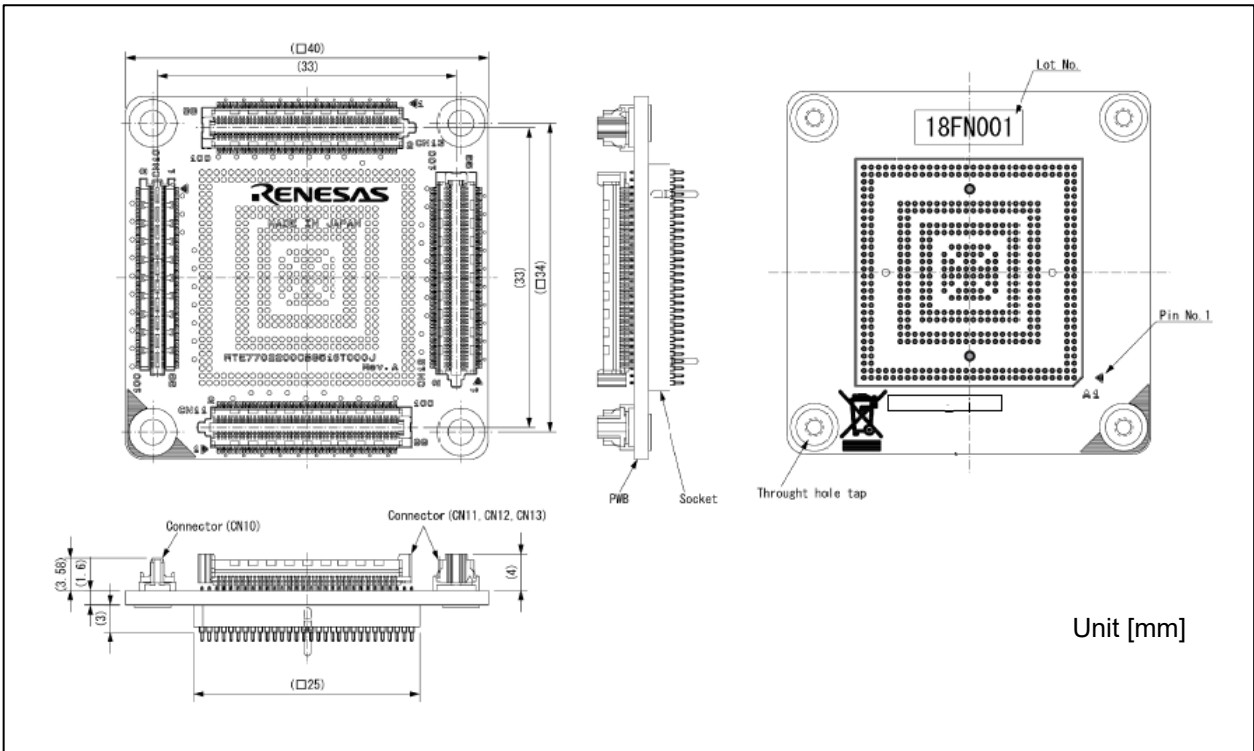

Figure A-2 Dimensions of the RTE7702200CBG516T000J (516 pins)

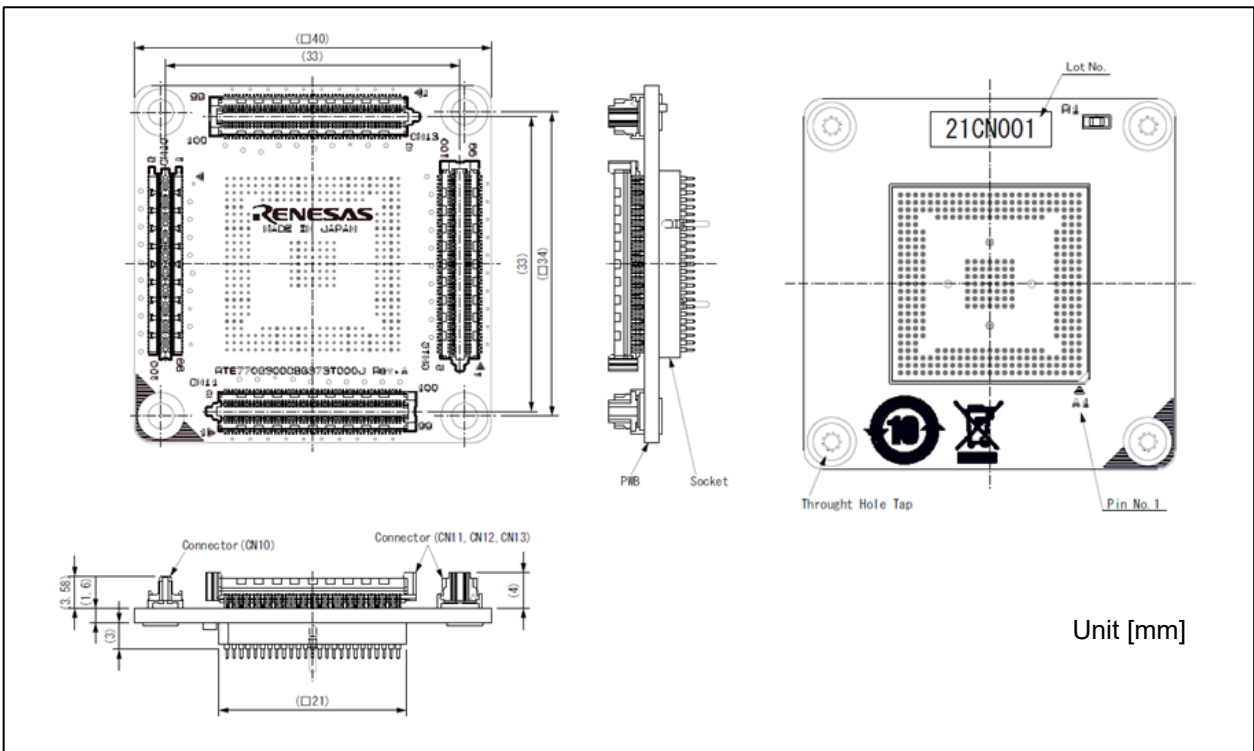

Figure A-3 Dimensions of the RTE7702300CBG373T000J (373 pins)

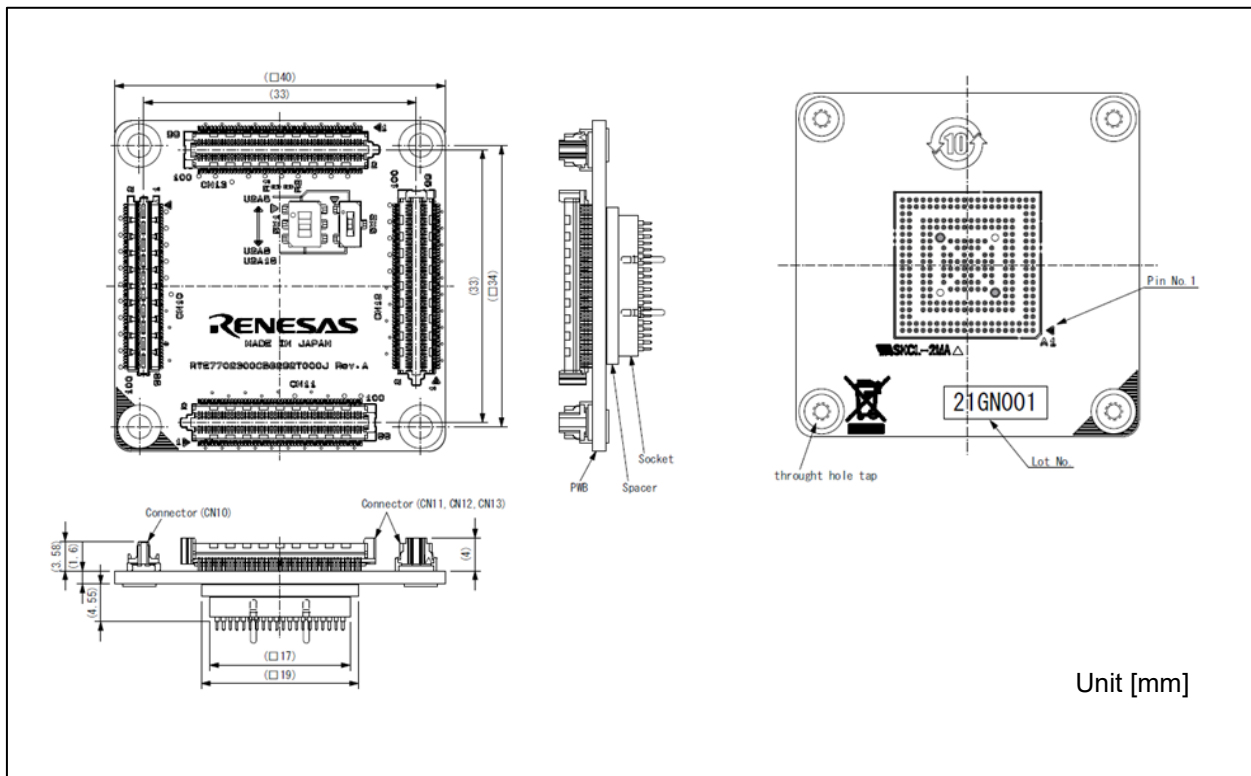

Figure A-4 Dimensions of the RTE7702300CBG292T000J (292 pins)

(7) Drawing of the assembly

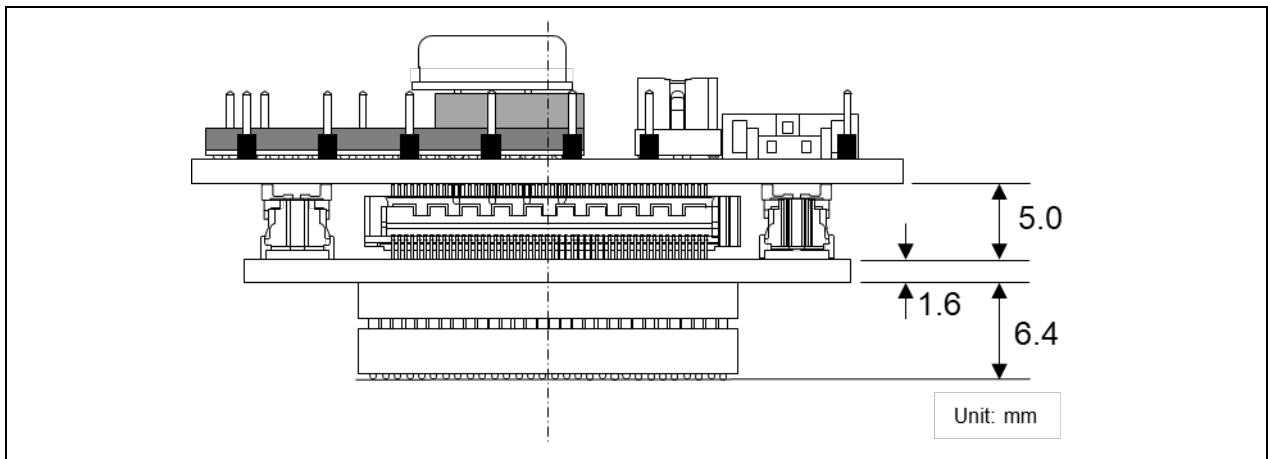

Figure A-5 Drawing of the Assembly for the RTE7702200CBG516T000J (516 pins)

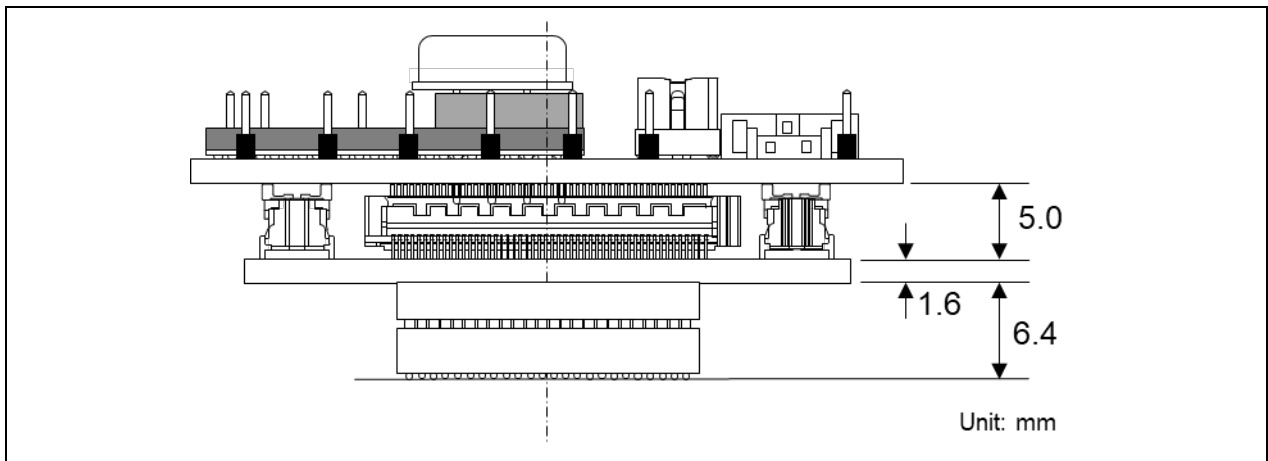

Figure A-6 Drawing of the Assembly for the RTE7702300CBG373T000J (373 pins)

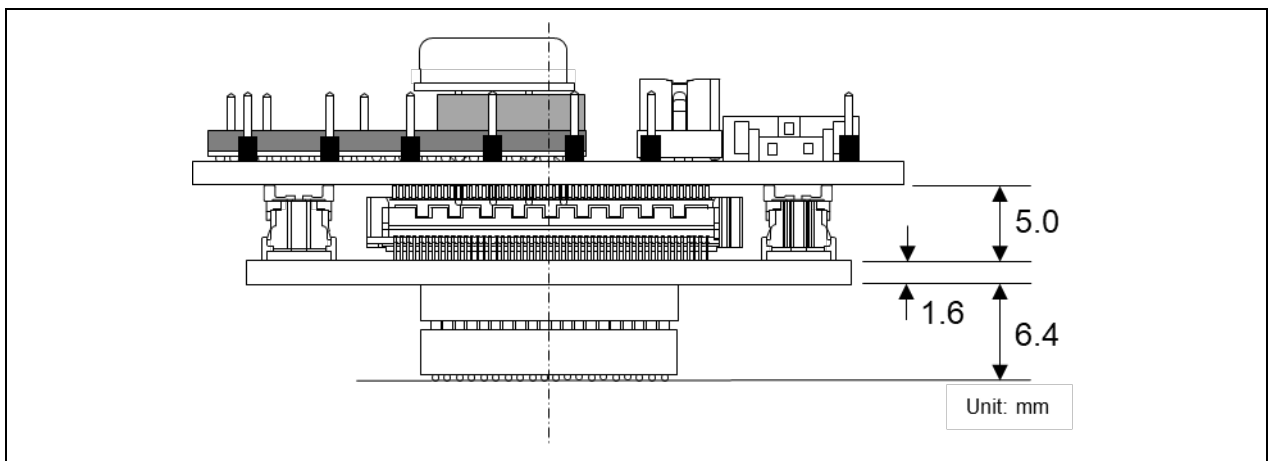
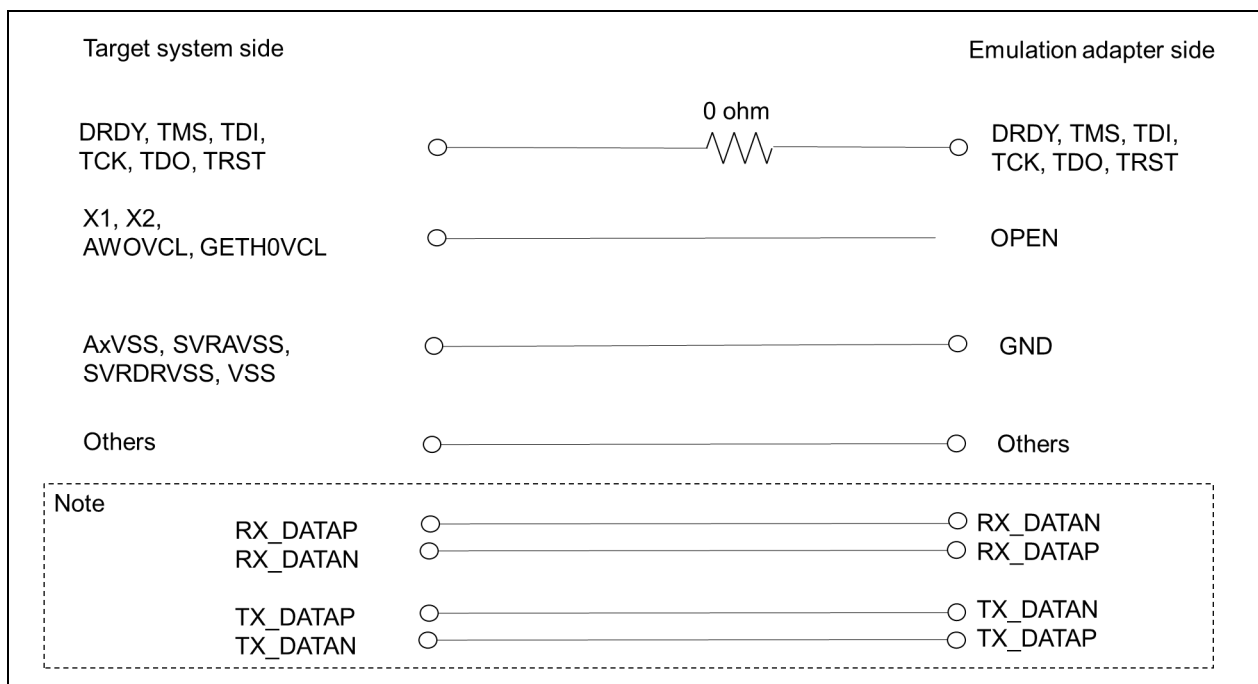

Figure A-7 Drawing of the Assembly for the RTE7702300CBG292T000J (292 pins)

(8) Characteristics of the target interface



Note: The Ethernet AVB (SGMII) cannot be emulated through the emulation adapter (by the debug chip). DATAP and DATAN are connected to each other on the exchange adapter; however, this incorrect connection will not damage the device.

Figure A-8 Equivalent Circuit for the RTE7702200CBG516T000J

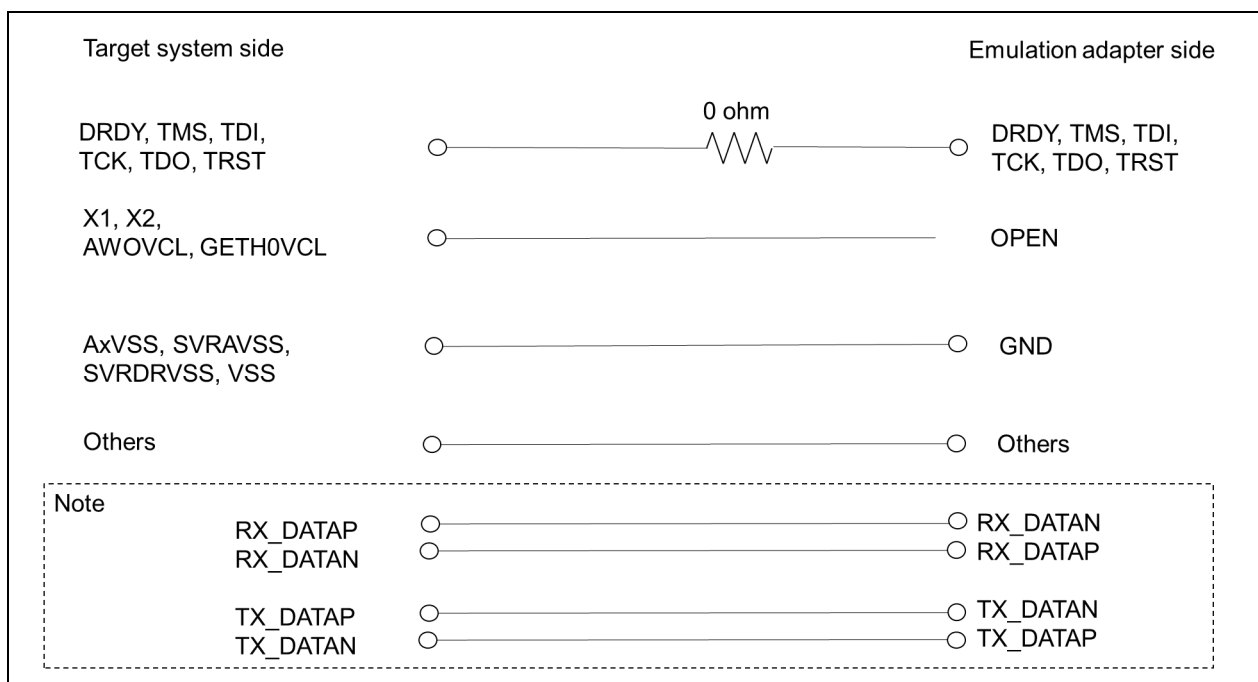

Note: The Ethernet AVB (SGMII) cannot be emulated through the emulation adapter (by the debug chip). DATAP and DATAN are connected to each other on the exchange adapter; however, this incorrect connection will not damage the device.

Figure A-9 Equivalent Circuit for the RTE7702300CBG373T000J

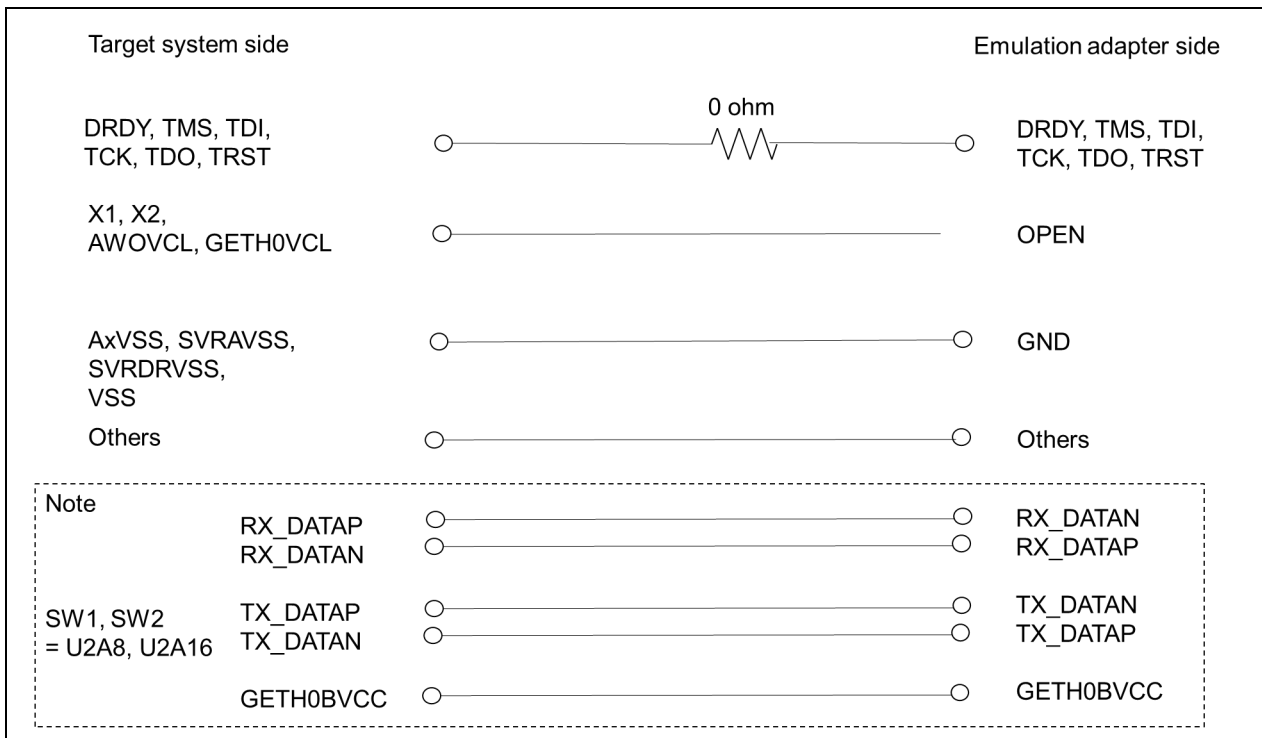

Note: The Ethernet AVB (SGMII) cannot be emulated through the emulation adapter (by the debug chip). DATAP and DATAN are connected to each other on the exchange adapter; however, this incorrect connection will not damage the device.

Figure A-10 Equivalent Circuit for the RTE7702300CBG292T000J (When the SW1 and SW2 Positions are for U2A8 and U2A16)

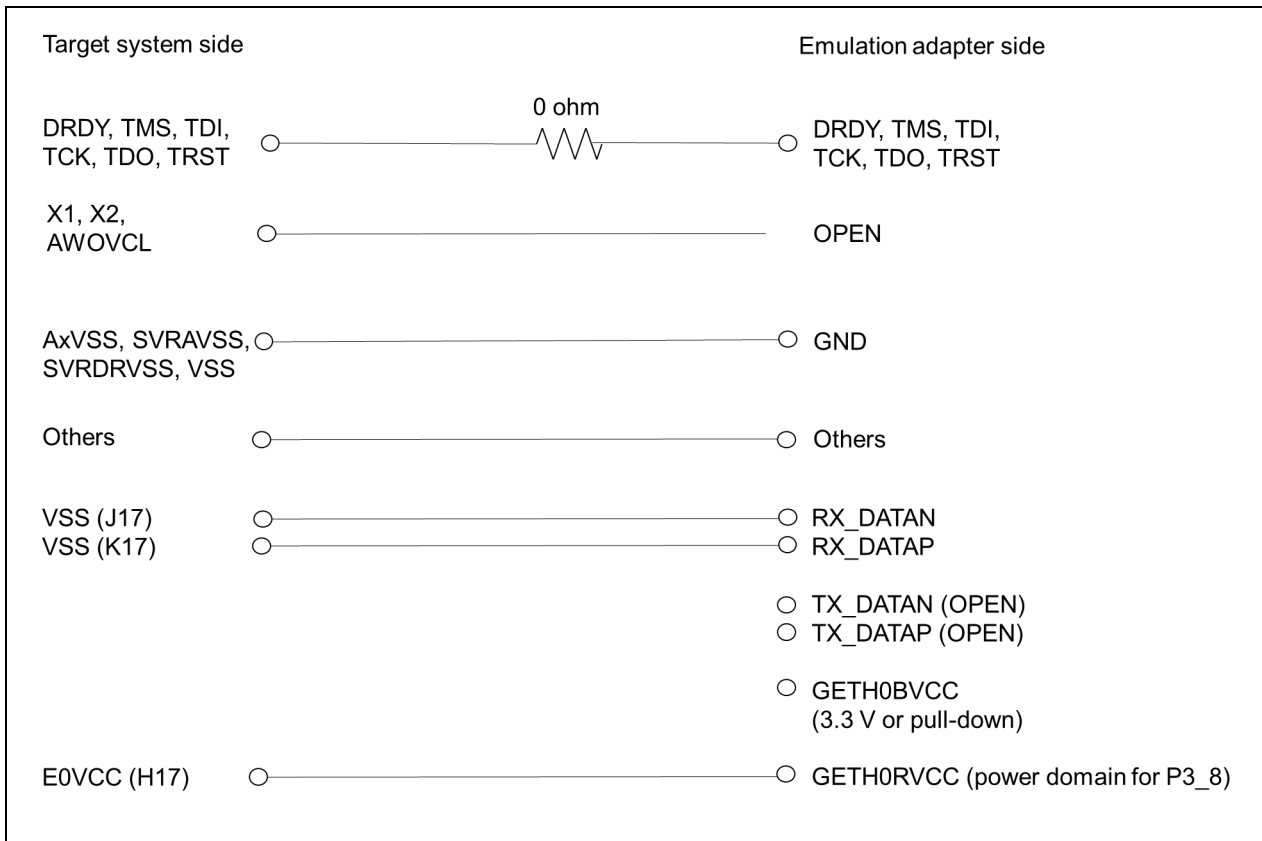

Figure A-11 Equivalent Circuit for the RTE7702300CBG292T000J (When the SW1 and SW2 Positions are for U2A6)

(9) Precautions and WEEE directive**CAUTION**

If the requirements shown in the "CAUTION" sentences are ignored, the equipment may cause personal injury or damage to the products.

⚠ CAUTION

Cautions to be Taken for This Product:



- Inquiries regarding CSSOCKET used for adjusting the height of the assembly, please send an email to the address below.

Tokyo Eletech Corporation http://www.tetc.co.jp/e_index.htm

IMPORTANT

Note on This Product:

- The exchange adapter is not reparable.
- Inquiries regarding the purchase of BSSOCKET, CSSOCKET, and LSPACK, please send an email to the address below.

Tokyo Eletech Corporation http://www.tetc.co.jp/e_index.htm

Caution to Be Taken for Disposal:



Penalties may be applicable for incorrect disposal of this waste, in accordance with your national legislation.

European Union Regulatory Notices:



The WEEE (Waste Electrical and Electronic Equipment) regulations put responsibilities on producers for the collection and recycling or disposal of electrical and electronic waste. Return of WEEE under these regulations is applicable in the European Union only. This equipment (including all accessories) is not intended for household use. After use the equipment cannot be disposed of as household waste, and the WEEE must be treated, recycled and disposed of in an environmentally sound manner.

Renesas Electronics Europe GmbH can take back end of life equipment, register for this service at "<http://www.renesas.eu/weee>".

All trademarks and registered trademarks are the property of their respective owners.

Revision History	Emulation Adapter for the RH850/U2A User's Manual
------------------	---

Rev.	Date	Description	
		Page	Summary
1.00	Jun.10.19	—	First Edition issued
1.10	Sep.15.23	30	Section 4.1.1: U2A6 was added to the description.
		36, 39, 41, 42	Appendix A: The FBGA-373 0.8-mm ball-pitch exchange adapter was added.
		36, 37, 38, 41, 43, 44	Appendix A: The type name of the FBGA-292 0.8-mm ball-pitch exchange adapter was changed from RTE7702100CBG292T000J to RTE7702300CBG292T000J.

Emulation Adapter for the RH850/U2A User's Manual

Publication Date: Rev.1.00 Jun.10.19
Rev.1.10 Sep.15.23

Published by: Renesas Electronics Corporation

Emulation Adapter for the RH850/U2A

RTE7702200EAB00000J

User's Manual



Renesas Electronics Corporation

R20UT4569EJ0110