

ISL6401EVAL1Z

Using the ISL6401 RSLIC PWM Controller Evaluation Board

AN1082
Rev 2.00
Jan 30, 2009

Functional Description

The ISL6401 pulse width modulating (PWM) current mode controller is designed for a wide range of DC/DC conversion applications including boost, flyback, and isolated output configurations. The device is optimized to provide high performance, low-cost solution for Ringing SLIC (RSLIC) Ring (Vbh) and Talk (Vbl) power supplies in VoIP applications. The IC features an integrated inverter that is ideal for generating negative output voltage like RSLIC Ring Vbh (-72V) and Talk Vbl (-24V), -48V for IP Phones, -5V and -15V for DSL CO line drivers. The output voltages are adjusted with an external voltage divider.

Peak current mode control architecture effectively handles Ring trip transients and provides inherent overcurrent protection. Flyback topology allows the operation close to 50% duty cycle, offering optimum transformer utilization, low ripple current and less stress on input/output capacitors. Internal soft-start minimizes start-up stress without any external components. The switching frequency can be programmed from 50kHz to 600kHz or alternatively, the internal oscillator can be locked to an external clock fed at SYNC input for noise sensitive applications. A logic level shutdown input is included, which reduces supply current to 55µA in the shutdown mode. DC/DC conversion efficiency is optimized by use of a low current sense voltage.

For a detailed functional description, complete specifications and component selection guidelines, please refer to the ISL6401 Data Sheet ("ISL6401: Synchronizing Current Mode PWM for Subscriber Line Interface Circuits"), Intersil Corporation, FN9007, available on Intersil's website, <http://www.intersil.com/data/fn/fn9007.pdf>

Application Information

As worldwide demand for inexpensive Voice over Internet Protocol telephony grows, so will the need for Integrated Circuits that are specialized to enable compatibility between new telephony systems and older telephones based on analog standards. Analog ring signal generation and off hook loop current supply are two analog functions that are performed by Subscriber Line Interface Circuits (SLICs). This application note discusses the special power supply implementation to generate the high negative voltages needed by SLICs.

Overview of Telephone Loop System

Traditionally, a telephone network consists of a circuit between the subscriber and the central office. However, the advent of new high speed digital technologies has created the need to control and manage the functions of the phone locally as opposed to the central office. In both instances the

principals governing the operation of the phone loop are essentially the same.

In a telephone loop, the subscriber is connected to the network via 2 wires, commonly known as Tip and Ring. The actual digital telecommunications trunk line however, operates on 4 wires; two of which are allocated for transmitting and two for receiving. This 2 to 4-wire interface consists of the SLIC and CODEC. A SLIC is the primary interface between the 4-wire (ground referenced) low voltage switch environment and the 2-wire (floating) high voltage loop environment. It performs a number of important functions including Battery feed, Overvoltage protection, Ringing, Signaling, Coding, Hybrid Balancing and also Testing.

The Ringing SLIC (RSLIC) typically requires two high voltage power supply inputs. The first is a tightly regulated voltage around -24V or -48V for off-hook signal transmission. The second is a loosely regulated -70V to -100V for ring tone generation. When the switch hook is released the phone puts approximately 200Ω of resistance across the phone terminals. Intersil RSLICs feature internal current limiting so this load is not presented to the power supply. However, not all of the SLICs available in the market offer this feature and the power supply is expected to maintain output during the remainder of the ring cycle. Once voice transmission begins, the SLIC, in many cases, requires a lower voltage input to establish a 20mA to 25mA current loop. The loop feeds the 200Ω, protection resistors, and line resistances within the phone. In some cases, the lower supply and higher supply voltage are combined and the SLIC runs from a compromise voltage of approximately -53V.

The specifications listed in the following table are for a 4-line requirement with 5 REN per line.

TABLE 1. TYPICAL POWER SUPPLY REQUIREMENT FOR VoIP RESIDENTIAL GATEWAY

PARAMETER	REQUIREMENT
Input Voltage	5V or 12V
Output Power	3W to 10W
Efficiency	80% to 90%
Output Voltages	-24V, -72 to -100V and/or -48V
-24V Requirements (4 lines)	Regulation: ±5% Maximum Output Current: 0.10A Ripple: Less than 0.25V _{p-p}
-72V Requirements (4 lines)	Regulation: ±10% Maximum Output Current: 0.10A Ripple: Less than 1V _{p-p}

Using the ISL6401EVAL1Z Evaluation Board

The ISL6401EVAL1Z Schematic shows a current mode power supply using the Intersil ISL6401 in standard flyback topology. The ISL6401EVAL1Z evaluation board is shipped “ready to use” right from the box. The IC requires +5V Bias. The evaluation board input voltage can be 10V to 16V with the specified transformer and external components. The output voltages are -24V at 120mA and -72V at 120mA. The board is capable of evaluating device operation with loads that simulate one, two, three or four line operation. The use of an electronic load enables evaluation over a wide range of operating conditions. Simply vary the load on each output from 0mA to 120mA in any combination to match exact application requirements. The circuit uses off-the-shelf inexpensive transformers to generate both outputs using a single controller. The transformer turns ratio is 1:1:1:1 where 24V appear across each secondary winding and the primary during the switch off-time. The remaining secondary windings are stacked in series to develop -48V. The -48V section is then stacked on the -24V section to get the -72V. This technique provides good cross regulation, lowers the voltage rating required for the output capacitors and lowers the RMS current, allowing the use of cheaper output capacitors. Also, the selection of a transformer with multifilar winding lowers the leakage inductance and cost. The cross regulation of both output is achieved by using split feedback for both outputs where the feedback factor can be weighed based on load condition on both outputs.

TABLE 2. ISL6401EVAL1Z EVALUATION BOARD

BOARD NAME	IC	PACKAGE
ISL6401EVAL1Z	ISL6401CBZ	14 Ld SOIC

The evaluation board kit also includes 5 samples of ISL6401CBZ and ISL6401CRZ each.

Recommended Test Equipment

- A 5V power supply to bias the IC.
- A 12V power supply capable of supplying 2A of current
- Two electronic loads
- Precision digital multimeters
- A 4-channel scope with probes

Power and Load Connections

The ISL6401EVAL1Z evaluation board has three sets of terminal posts and a jumper that are used to supply the input voltages and to monitor and load the outputs.

Jumper Settings - Jumper JP1 allows the ISL6401 to be biased from a separate 5V supply or from the input voltage at VIN using a zener diode.

If a 5V supply is being used for the VCC input, place a jumper connecting the pins to the left (pin 1 and pin 2) of JP1. Placing a jumper to the right (pin 2 and pin 3) of JP2 will supply the bias of the ISL6401 from the input voltage at VIN using a zener diode (D1).

Input Voltage - Adjust the power supplies to provide the 5V and 12V input voltages. With the power supplies turned off, connect the positive lead of the 5V supply to the VCC post (P3). Connect the ground lead of the supply to the GND post (P4). Connect the positive lead of the 12V supply to the VIN post (P1). Connect the ground lead to the GND post (P2).

Output Voltage Loading and Monitoring - To exercise and monitor VOUT1, connect the positive lead of one of the electronic loads to the GND post (P7). Connect the ground lead of the electronic load to the VOUT1 post (P8). Connect the positive end of a digital multimeter to the VOUT1 post (P8). Connect the digital multimeter ground terminal to the GND post (P7).

To exercise and monitor VOUT2, connect the positive lead of the other electronic load to the GND post (P10). Connect the ground lead of the electronic load to the VOUT1 post (P9). Connect the positive end of a digital multimeter to the VOUT1 post (P9). Connect the digital multimeter ground terminal to the GND post (P10).

Each output can be viewed with an oscilloscope using the two scope probes, SP1 (VOUT1) and SP2 (VOUT2).

Start-up

The ISL6401 features an internal digital soft-start to reduce transformer and output capacitor stress and to reduce the inrush current surge on the input circuits. Figure 1 shows the start-up sequence.

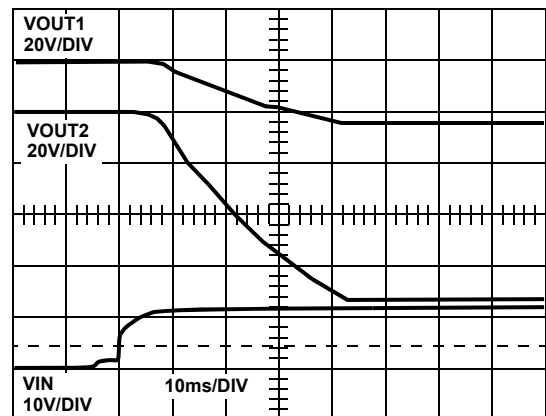

FIGURE 1. SOFT-START WAVEFORMS (2ms/DIV)

Output Performance

Output Ripple - Figure 2 shows the output voltage ripple for VOUT1 and VOUT2 both at 100mA load.

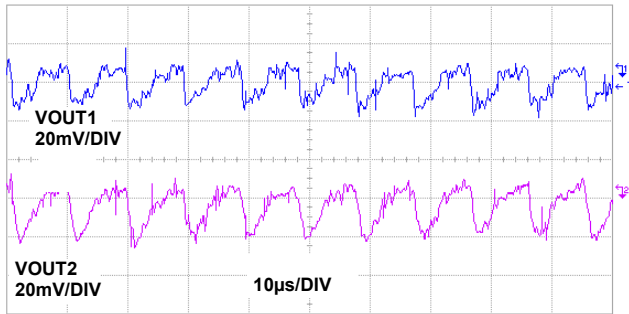

FIGURE 2. OUTPUT 1 AND 2 RIPPLE VOLTAGE

Transient Response - Figures 3 and 4 show the transient performance of the each output for a step load from 0mA to 100mA.

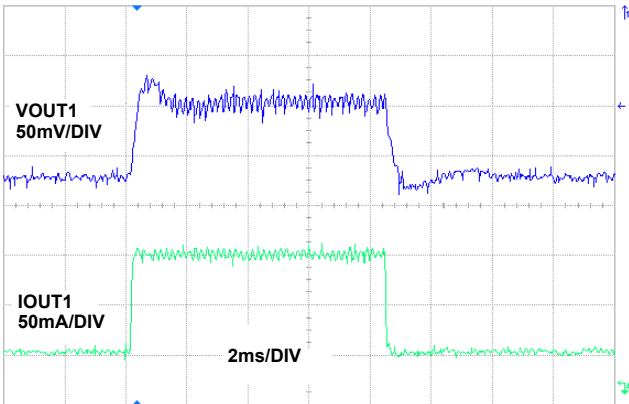

FIGURE 3. VOUT1 TRANSIENT RESPONSE

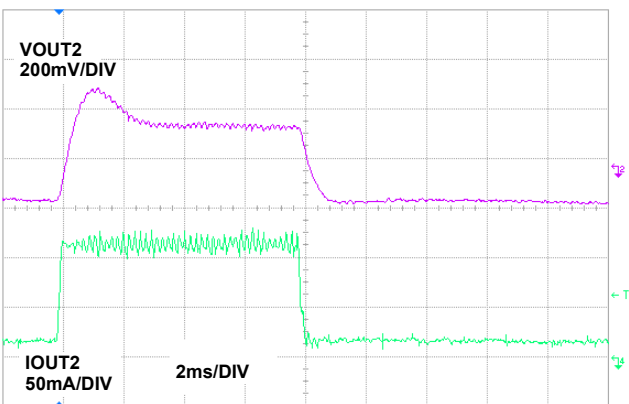

FIGURE 4. VOUT2 TRANSIENT RESPONSE

Oscillator

Switching Frequency - The gate driver output switching frequency can be programmed from 50kHz to 600kHz by adjusting the capacitor value on the CT pin (C5). Figure 5 can be used as a guideline in selecting the capacitor value required for a given frequency.

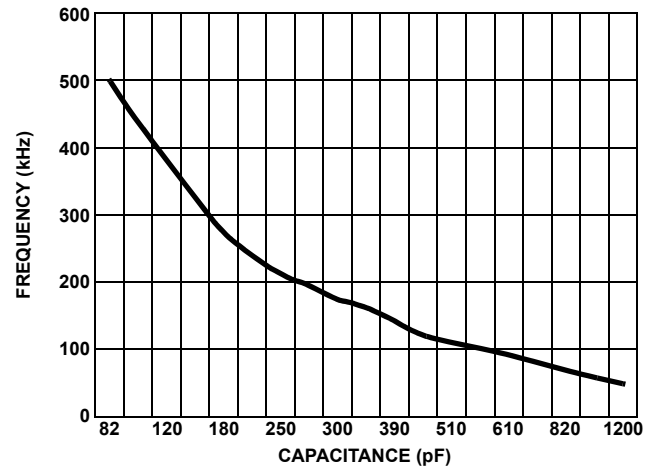

FIGURE 5. OUTPUT SWITCHING FREQUENCY vs CT

External Synchronization - The internal oscillator can be synchronized by an external clock connected to the SYNC pin (P6). Program the free running frequency of the oscillator to be 10% slower than the desired synchronous frequency. The external clock signal should have a minimum pulse width of 20ns.

Shutdown

When the SD pin (P5) is pulled low, the PWM is turned off and the output capacitors discharge. A typical shutdown waveform using the SD pin is shown in Figure 6.

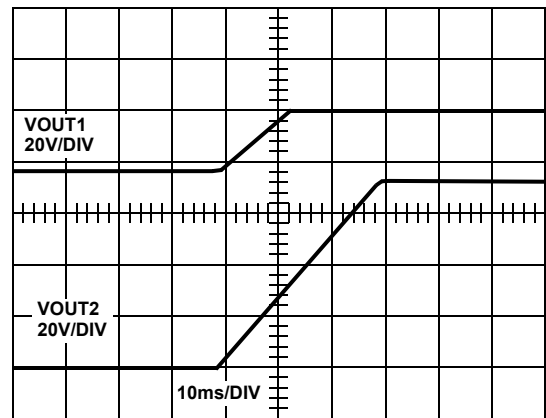

FIGURE 6. OUTPUT SHUTDOWN WAVEFORMS

Conclusion

The ISL6401EVAL1Z evaluation board is a flyback reference design optimized to provide a high performance, low-cost solution for RSLIC Ring and Talk power supplies in VoIP application. It has the capability of evaluating device operation with loads that simulate one, two, three, or four line operation.

References

1. ISL6401 Datasheet (“ISL6401: Synchronizing Current Mode PWM for Subscriber Line Interface Circuits”), Intersil Corporation, FN9007. For Intersil documents available on the web, see <http://www.intersil.com/>

ISL6401EVAL1Z Schematic

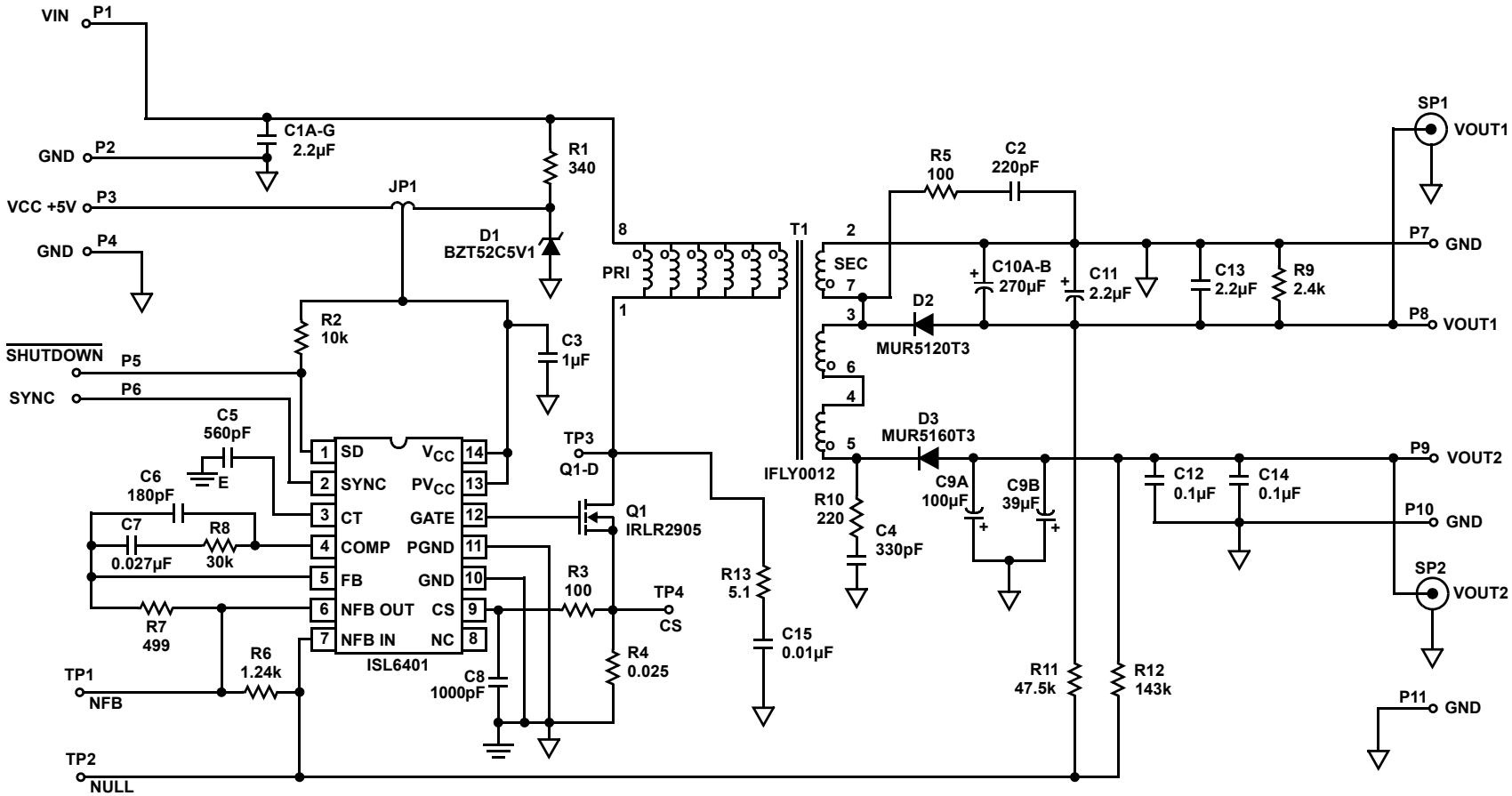

ISL6401EVAL1Z Bill of Materials

QTY	REFERENCE DESIGNATOR	DESCRIPTION	MANUFACTURER	MANUFACTURER PART
1		PWB-PCB, ISL6401EVAL1Z, REVA, SOIC, ROHS	TITAN	ISL6401EVAL1ZREVAPCB
1	C9A	CAP, RADIAL, 10 μ F, 100V, 20%, AL E, ROHS	SANYO	100ME100AX
1	C9B	CAP, RADIAL, 39 μ F, 100V, 20%, AL ELEC, ROHS	SANYO	100ME39AX
1	C10A	CAP, RADIAL, 10x16, 270 μ F, 35V, 20%, AL.EL., ROHS	SANYO	35ME270AX
1	C8	CAP, SMD, 0805, 1000pF, 50V, 5%, NPO, ROHS	PANASONIC	ECU-V1H102JCX
1	C15	CAP, SMD, 0805, 0.01 μ F, 50V, 5%, X7R, ROHS	VENKEL	C0805X7R500-103JNE
1	C6	CAP, SMD, 0805, 180pF, 50V, 5%, NPO, ROHS	VENKEL	C0805COG500-181JNE
1	C2	CAP, SMD, 0805, 220pF, 50V, 10%, X7R, ROHS	VENKEL	C0805X7R500-221KNE
1	C7	CAP, SMD, 0805, 0.027 μ F, 50V, 10%, X7R, ROHS		
1	C5	CAP, SMD, 0805, 560pF, 50V, 5%, NPO, ROHS	MINI-REEL	605-356
1	C4	CAP, SMD, 1206, 330pF, 100V, 5%, NPO, ROHS	VENKEL	C1206COG101-331JNE
9	C1A-C1G, C11, C13	CAP, SMD, 1210, 2.2 μ F, 50V, 10%, X7R, ROHS	TDK	C3225X7R1H225K
2	C12, C14	CAP, SMD, 1812, 0.1 μ F, 100V, 20%, X7R, ROHS	VENKEL	C1812X7R101-104MNE
1	C3	CAP, SMD, 1812, 1 μ F, 50V, 10%, X7R, ROHS	VENKEL	C1812X7R500-105KNE
2	SP1, SP2	CONN-GEN, SHIELDED TEST JACK, VERTICAL, ROHS	JOHNSON COMPONENTS	129-0701-202
10	P1-P10	CONN-TURRET, TERMINAL POST, TH, ROHS	KEYSTONE	1514-2
4	TP1-TP4	CONN-MINI TEST POINT, VERTICAL, WHITE, ROHS	KEYSTONE	5002
1	JP1	CONN-HEADER, 1x3, BRKAWY 1x36, 2.54mm, ST	BERG/FCI	68000-236-1X3
1	JP1 (place on pin 1 and 2)	CONN-JUMPER, SHORTING, 2PIN, BLACK, GOLD, ROHS	SULLINS	SPC02SYAN
1	D1	DIODE-ZENER, SMD, SOD-123, 5.1V, 500mW, ROHS	DIODES, INC.	BZT52C5V1-7-F
1	D2	DIODE-RECTIFIER, SMD, SMB, 2P, 1A, 200V, ROHS	ON SEMICONDUCTOR	MURS120T3G
1	D3	DIODE-RECTIFIER, SMD, SMB, 2P, 1A, 600V, ROHS	ON SEMICONDUCTOR	MURS160T3G
5	PURCHASE, DNP. BAG AND SHIP W/BOARD.	IC-RSLIC PWM, 14P, SOIC, ROHS	INTERSIL	ISL6401CBZ
1	U1	IC-RSLIC PWM, 14P, SOIC, ROHS	INTERSIL	ISL6401CBZ
5	PURCHASE, DNP. BAG AND SHIP W/BOARD.	IC-RSLIC PWM CONTROLLER, 16P, QFN, 4x4, ROHS	INTERSIL	ISL6401CRZ
1	Q1	TRANSIST-MOS, N-CHANNEL, SMD, D-PAK, 42A, ROHS	INTERNATIONAL RECTIFIER	IRLR2905PBF
1	R3	RESISTOR, 0805, 100 Ω , 1/8W, 1%, TF, ROHS	VENKEL	CR0805-8W-1000FT
1	R2	RES, SMD, 0805, 10k, 1/8W, 1%, TF, ROHS	VENKEL	CR0805-8W-1002FT(PbFREE)
1	R6	RES, SMD, 0805, 1.24k, 1/8W, 1%, TF, ROHS	PANASONIC	ERJ-6ENF1241V
1	R12	RES, SMD, 0805, 143k, 1/8W, 1%, TF, ROHS	PANASONIC	ERJ-6ENF1433V
1	R8	RES, SMD, 0805, 30k, 1/8W, 1%, TF, ROHS		
1	R11	RES, SMD, 0805, 47.5k, 1/8W, 1%, TF, ROHS	KOA	RK73H2AT4752F
1	R7	RES, SMD, 0805, 499 Ω , 1/8W, 1%, TF, ROHS	YAGEO	RC0805FR-07499RL
1	R5	RES, SMD, 1206, 100 Ω , 1/4W, 1%, TF, ROHS	STACKPOLE	RMC1/8 100R 1% T/R
1	R10	RES, SMD, 1206, 220 Ω , 1/4W, 5%, TF, ROHS	VISHAY	CRCW1206221J
1	R13	RES, SMD, 1210, 5.1 Ω , 1/4W, 5%, TF, ROHS	PANASONIC	ERJ-14YJ5R1U
1	R4	RES, SMD, 2512, 0.025 Ω , 1W, 1%, TF, ROHS	DALE	WSL-2512-.0251%
1	R1	RES, SMD, 2010, 332 Ω , 1/2W, 1%, TF, ROHS	PANASONIC	ERJ-12SF3320U

ISL6401EVAL1Z Bill of Materials (Continued)

QTY	REFERENCE DESIGNATOR	DESCRIPTION	MANUFACTURER	MANUFACTURER PART
1	T1	TRANSFORMER-FLYBACK, 6.0μH, 10%, SMD, 8P, 25x17, ROHS	GCI TECHNOLOGIES	IFLY0012/G013064LF
4	Four corners.	SCREW, 4-40x1/2in, PAN, NYLON, PHILLIPS, ROHS		
4	Four corners.	STANDOFF, 4-40x3/4in, F/F, HEX, NYLON	KEYSTONE	1902D
1	Place assy in bag	BAG, STATIC, 5x8, ZIP LOC	INTERSIL	212403-013
0	C10B	DO NOT POPULATE OR PURCHASE		
0	R9	DO NOT POPULATE OR PURCHASE		
1		LABEL, FOR SERIAL NUMBER AND BOM REV #		

ISL6401EVAL1Z Layout

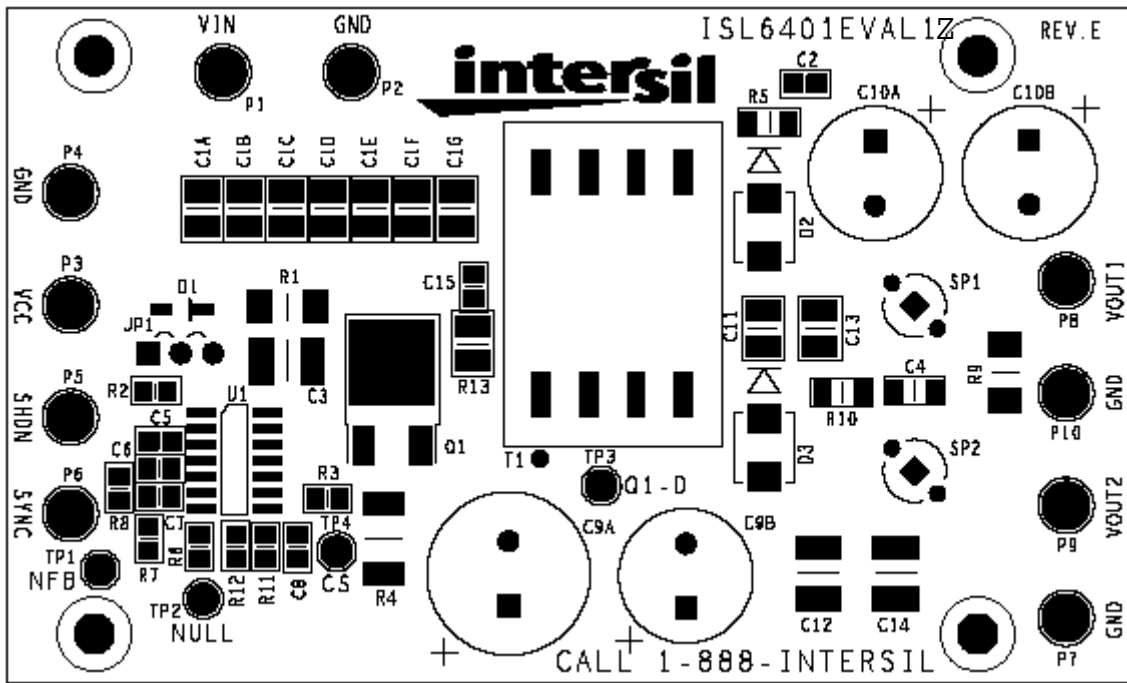

FIGURE 7. TOP SILKSCREEN

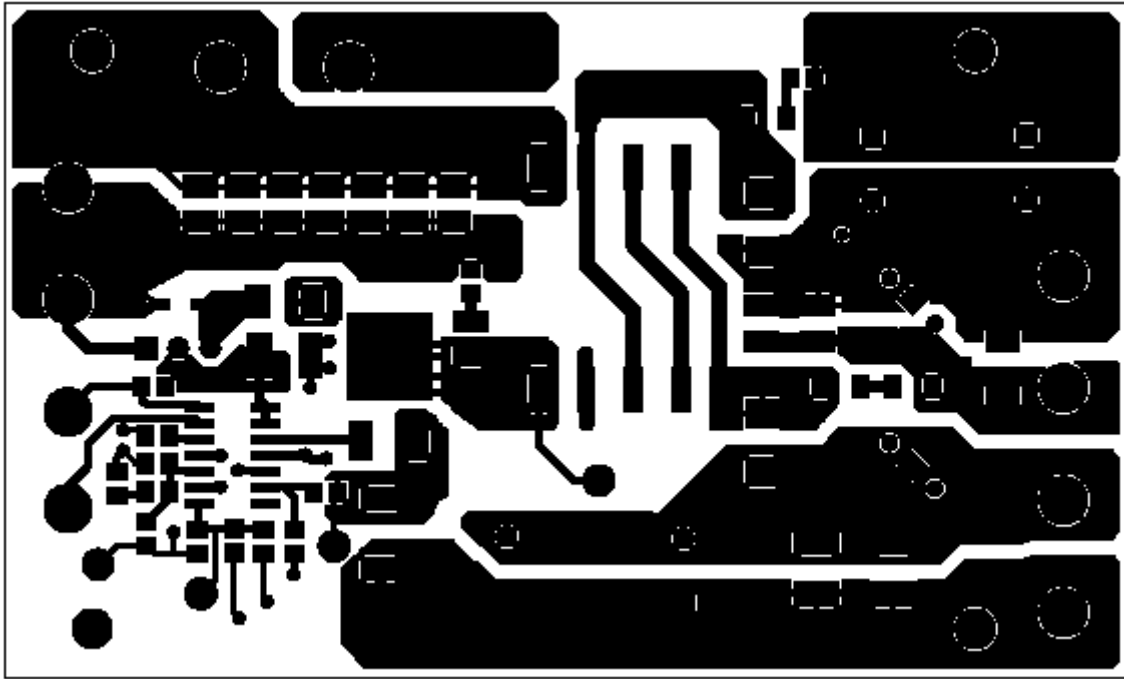

FIGURE 8. TOP LAYER 1

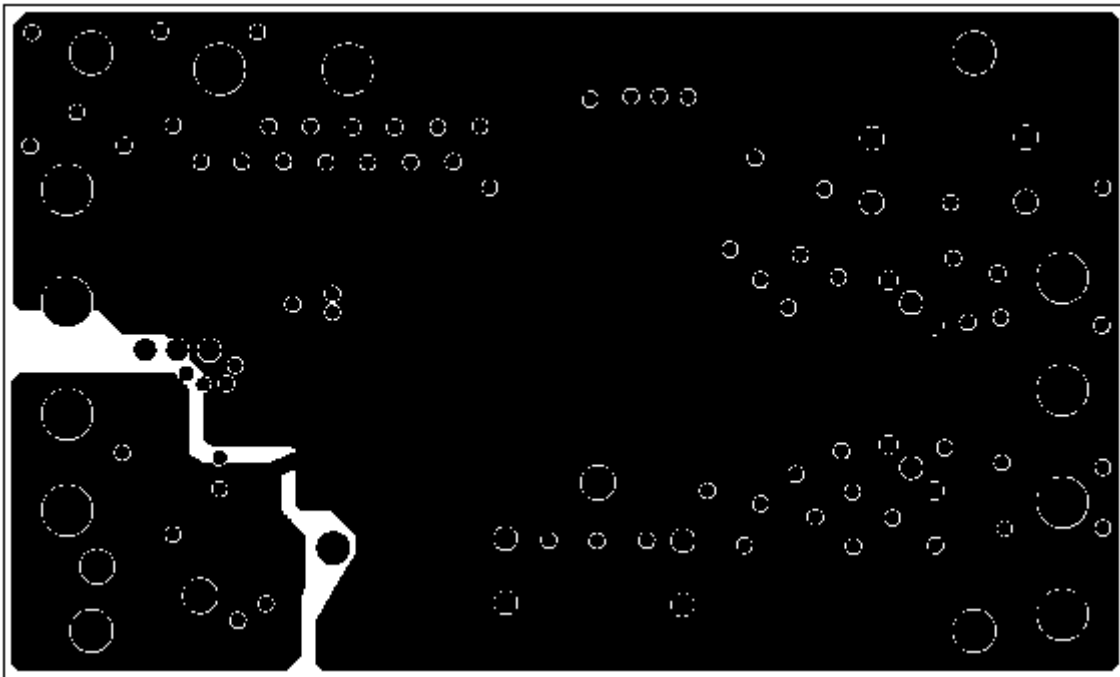

FIGURE 9. TOP LAYER 2

ISL6401EVAL1Z Layout (Continued)

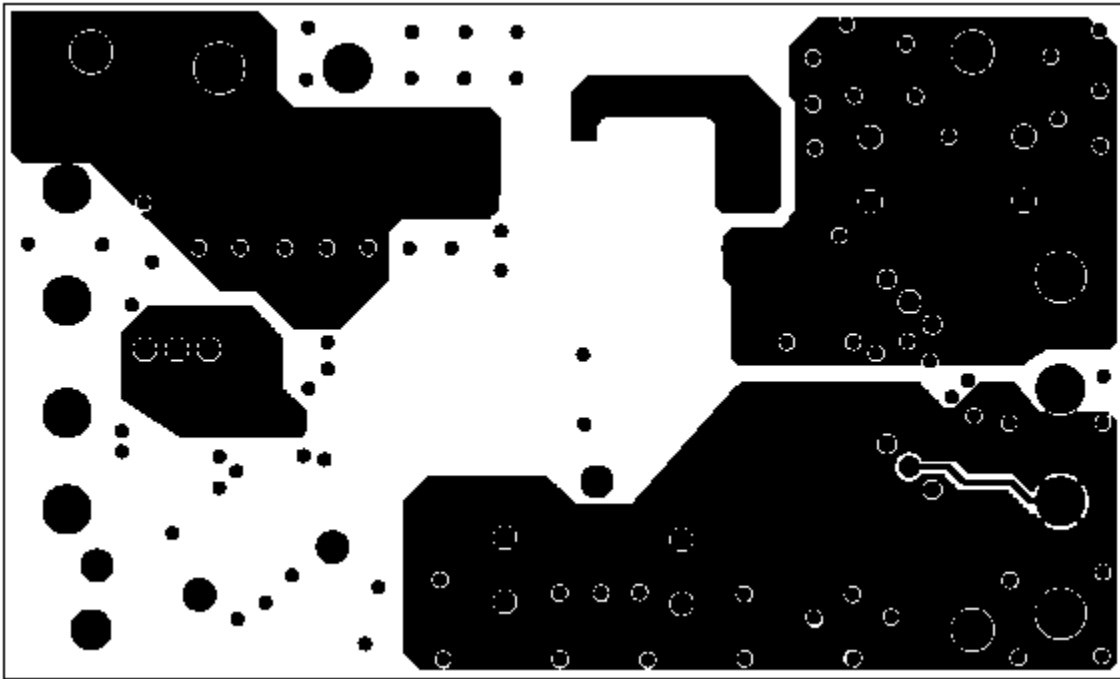

FIGURE 10. TOP LAYER 3

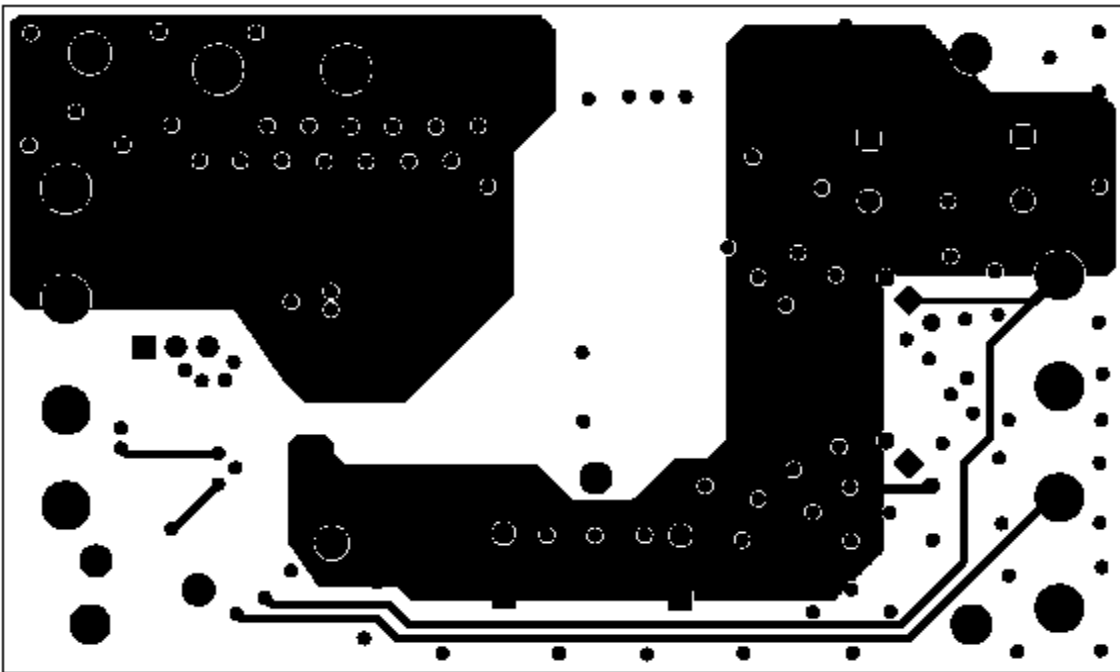

FIGURE 11. BOTTOM SILKSCREEN

Notice

1. Descriptions of circuits, software and other related information in this document are provided only to illustrate the operation of semiconductor products and application examples. You are fully responsible for the incorporation or any other use of the circuits, software, and information in the design of your product or system. Renesas Electronics disclaims any and all liability for any losses and damages incurred by you or third parties arising from the use of these circuits, software, or information.
2. Renesas Electronics hereby expressly disclaims any warranties against and liability for infringement or any other claims involving patents, copyrights, or other intellectual property rights of third parties, by or arising from the use of Renesas Electronics products or technical information described in this document, including but not limited to, the product data, drawings, charts, programs, algorithms, and application examples.
3. No license, express, implied or otherwise, is granted hereby under any patents, copyrights or other intellectual property rights of Renesas Electronics or others.
4. You shall not alter, modify, copy, or reverse engineer any Renesas Electronics product, whether in whole or in part. Renesas Electronics disclaims any and all liability for any losses or damages incurred by you or third parties arising from such alteration, modification, copying or reverse engineering.
5. Renesas Electronics products are classified according to the following two quality grades: "Standard" and "High Quality". The intended applications for each Renesas Electronics product depends on the product's quality grade, as indicated below.
"Standard": Computers; office equipment; communications equipment; test and measurement equipment; audio and visual equipment; home electronic appliances; machine tools; personal electronic equipment; industrial robots; etc.
"High Quality": Transportation equipment (automobiles, trains, ships, etc.); traffic control (traffic lights); large-scale communication equipment; key financial terminal systems; safety control equipment; etc.
Unless expressly designated as a high reliability product or a product for harsh environments in a Renesas Electronics data sheet or other Renesas Electronics document, Renesas Electronics products are not intended or authorized for use in products or systems that may pose a direct threat to human life or bodily injury (artificial life support devices or systems; surgical implantations; etc.), or may cause serious property damage (space system; undersea repeaters; nuclear power control systems; aircraft control systems; key plant systems; military equipment; etc.). Renesas Electronics disclaims any and all liability for any damages or losses incurred by you or any third parties arising from the use of any Renesas Electronics product that is inconsistent with any Renesas Electronics data sheet, user's manual or other Renesas Electronics document.
6. When using Renesas Electronics products, refer to the latest product information (data sheets, user's manuals, application notes, "General Notes for Handling and Using Semiconductor Devices" in the reliability handbook, etc.), and ensure that usage conditions are within the ranges specified by Renesas Electronics with respect to maximum ratings, operating power supply voltage range, heat dissipation characteristics, installation, etc. Renesas Electronics disclaims any and all liability for any malfunctions, failure or accident arising out of the use of Renesas Electronics products outside of such specified ranges.
7. Although Renesas Electronics endeavors to improve the quality and reliability of Renesas Electronics products, semiconductor products have specific characteristics, such as the occurrence of failure at a certain rate and malfunctions under certain use conditions. Unless designated as a high reliability product or a product for harsh environments in a Renesas Electronics data sheet or other Renesas Electronics document, Renesas Electronics products are not subject to radiation resistance design. You are responsible for implementing safety measures to guard against the possibility of bodily injury, injury or damage caused by fire, and/or danger to the public in the event of a failure or malfunction of Renesas Electronics products, such as safety design for hardware and software, including but not limited to redundancy, fire control and malfunction prevention, appropriate treatment for aging degradation or any other appropriate measures. Because the evaluation of microcomputer software alone is very difficult and impractical, you are responsible for evaluating the safety of the final products or systems manufactured by you.
8. Please contact a Renesas Electronics sales office for details as to environmental matters such as the environmental compatibility of each Renesas Electronics product. You are responsible for carefully and sufficiently investigating applicable laws and regulations that regulate the inclusion or use of controlled substances, including without limitation, the EU RoHS Directive, and using Renesas Electronics products in compliance with all these applicable laws and regulations. Renesas Electronics disclaims any and all liability for damages or losses occurring as a result of your noncompliance with applicable laws and regulations.
9. Renesas Electronics products and technologies shall not be used for or incorporated into any products or systems whose manufacture, use, or sale is prohibited under any applicable domestic or foreign laws or regulations. You shall comply with any applicable export control laws and regulations promulgated and administered by the governments of any countries asserting jurisdiction over the parties or transactions.
10. It is the responsibility of the buyer or distributor of Renesas Electronics products, or any other party who distributes, disposes of, or otherwise sells or transfers the product to a third party, to notify such third party in advance of the contents and conditions set forth in this document.
11. This document shall not be reprinted, reproduced or duplicated in any form, in whole or in part, without prior written consent of Renesas Electronics.
12. Please contact a Renesas Electronics sales office if you have any questions regarding the information contained in this document or Renesas Electronics products.
(Note 1) "Renesas Electronics" as used in this document means Renesas Electronics Corporation and also includes its directly or indirectly controlled subsidiaries.
(Note 2) "Renesas Electronics product(s)" means any product developed or manufactured by or for Renesas Electronics.

(Rev.4.0-1 November 2017)



SALES OFFICES

Renesas Electronics Corporation

<http://www.renesas.com>

Refer to "<http://www.renesas.com/>" for the latest and detailed information.

Renesas Electronics America Inc.
1001 Murphy Ranch Road, Milpitas, CA 95035, U.S.A.
Tel: +1-408-432-8888, Fax: +1-408-434-5351

Renesas Electronics Canada Limited
9251 Yonge Street, Suite 8309 Richmond Hill, Ontario Canada L4C 9T3
Tel: +1-905-237-2004

Renesas Electronics Europe Limited
Dukes Meadow, Millboard Road, Bourne End, Buckinghamshire, SL8 5FH, U.K
Tel: +44-1628-651-700, Fax: +44-1628-651-804

Renesas Electronics Europe GmbH
Arcadiastrasse 10, 40472 Düsseldorf, Germany
Tel: +49-211-6503-0, Fax: +49-211-6503-1327

Renesas Electronics (China) Co., Ltd.
Room 1709 Quantum Plaza, No.27 ZhichunLu, Haidian District, Beijing, 100191 P. R. China
Tel: +86-10-8235-1155, Fax: +86-10-8235-7679

Renesas Electronics (Shanghai) Co., Ltd.
Unit 301, Tower A, Central Towers, 555 Langao Road, Putuo District, Shanghai, 200333 P. R. China
Tel: +86-21-2226-0888, Fax: +86-21-2226-0999

Renesas Electronics Hong Kong Limited
Unit 1601-1611, 16/F., Tower 2, Grand Century Place, 193 Prince Edward Road West, Mongkok, Kowloon, Hong Kong
Tel: +852-2265-6688, Fax: +852-2886-9022

Renesas Electronics Taiwan Co., Ltd.
13F, No. 363, Fu Shing North Road, Taipei 10543, Taiwan
Tel: +886-2-8175-9600, Fax: +886-2-8175-9670

Renesas Electronics Singapore Pte. Ltd.
80 Bendemeer Road, Unit #06-02 Hyflux Innovation Centre, Singapore 339949
Tel: +65-6213-0200, Fax: +65-6213-0300

Renesas Electronics Malaysia Sdn.Bhd.
Unit 1207, Block B, Menara Amcorp, Amcorp Trade Centre, No. 18, Jln Persiaran Barat, 46050 Petaling Jaya, Selangor Darul Ehsan, Malaysia
Tel: +60-3-7955-9390, Fax: +60-3-7955-9510

Renesas Electronics India Pvt. Ltd.
No.777C, 100 Feet Road, HAL 2nd Stage, Indiranagar, Bangalore 560 038, India
Tel: +91-80-67208700, Fax: +91-80-67208777

Renesas Electronics Korea Co., Ltd.
17F, KAMCO Yangjae Tower, 262, Gangnam-daero, Gangnam-gu, Seoul, 06265 Korea
Tel: +82-2-558-3737, Fax: +82-2-558-5338