

ISL78200EVAL1Z Evaluation Board Setup Procedure

The ISL78200EVAL1Z board is used to demonstrate the synchronous/asynchronous buck or boost buck operation of the ISL78200.

The ISL78200EVAL1Z board input voltage range is 3V to 40V.

The output voltage is set to 5V and can be changed by voltage feedback resistors. Note that to make the output voltage higher, the output capacitors' voltage rating needs to be checked.

The board output current is 2A typical. The board is set to a default overcurrent threshold of 3.6A. The OC threshold can be programmed by the resistor at the ILIMIT pin.

The ISL78200EVAL1Z board has setting options, which can be configured to synchronous buck, asynchronous buck, boost-buck topologies, forced PWM mode or PFM mode.

The board is set to a default frequency of 500kHz. The frequency can be programmed by the resistor at the FS pin.

The board can be synchronized to the external clock. Multiple ISL78200EVAL1Z boards can be synchronized simply by connecting their SYNC pins together.

Recommended Equipment

- 0V to 40V power supply with at least 5A source current capability
- Load capable of sinking current up to 3A
- Multimeters
- Oscilloscope

Input and Output Connectors

The board has 2 main circuits sections - buck and boost, as shown in Figure 1.

1. For synchronous/asynchronous buck, the inputs are J1(VIN+) and J2(GND). The outputs are J3(VOUT+) and J4(GND).
2. For boost buck operation, the inputs of the boost are J5(VIN_BOOST+) and J6(GND) and the boost output positive terminal is J31(VOUT_BOOST+). By shorting J26 and J27, the boost outputs are connected to the inputs of the buck. The outputs of the buck are still J3(VOUT+) and J4(GND).

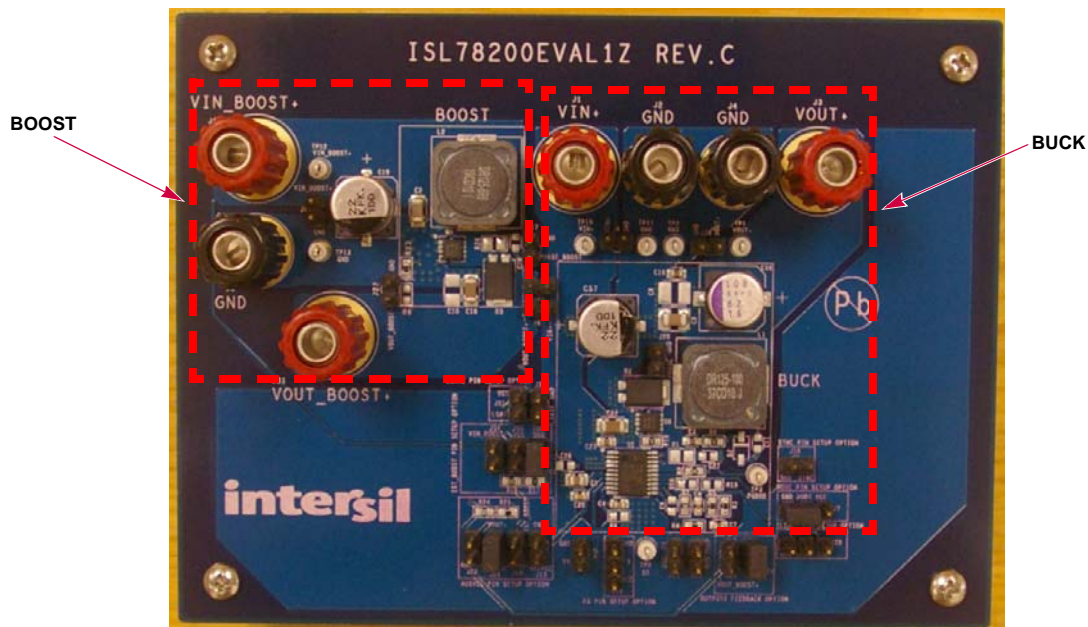

FIGURE 1. ISL78200EVAL1Z BOARD IMAGE

Board Setup and Startup Sequence

Synchronous Buck

1. Ensure J25 is shorted for the voltage feedback connection.
2. Ensure J30 is shorted for non-boost mode.
3. The MODE and GND pins of J7 are shorted for forced PWM mode (no PFM). If PFM mode is desired, short MODE pin to VCC pin of J7 or leave MODE pin floating.
4. J11 is shorted to have AUXVCC connected to VOUT, and J13, J10, J12 should be OPEN. If AUXVCC switch-over function is not desired, open J11 and short J13.
5. Leave all the other jumper connectors open.
6. Connect the power source to the inputs J1(VIN+) and J2(GND). Connect the load terminals to the buck outputs J3(VOUT+) and J4(GND). Make sure the setup is correct prior to applying any power or load to the board.
7. Adjust the power source to 12V and turn it on.
8. Verify the output voltage is 5V and use the oscilloscope to monitor the phase node waveforms (J28).

Asynchronous Buck

1. Ensure J25 is shorted for the voltage feedback connection.
2. Ensure J30 is shorted for non-boost mode.
3. Ensure the MODE and GND pins of J7 are shorted with jumper for forced PWM mode (no PFM). If PFM mode is desired, short MODE pin to VCC pin of J7 or leave MODE pin floating.
4. Ensure J11 is shorted for AUXVCC connected to VOUT setup, and J13, J10, J12 should be OPEN. If AUXVCC switch-over function is not desired, open J11 and short J13.
5. Remove R19. Change R20 (on bottom of the board) to 0Ω to keep Q6 securely off.
6. Leave all the other jumpers connectors open.
7. Connect the power source to the inputs J1(VIN+) and J2(GND). Connect the load terminals to the buck outputs J3(VOUT+) and J4(GND). Make sure the setup is correct prior to applying any power or load to the board.
8. Adjust the power source to 12V and turn it on.
9. Verify the output voltage is 5V and use oscilloscope to monitor the phase node waveforms (J28).

Boost Buck

1. Remove R19 and leave it open. Change R20 (on bottom of the board) to 0Ω to keep Q6 securely off.
2. Install 0Ω resistor at R9 to set up LGATE to drive the boost switch Q5.
3. Short jumpers J26 and J27 to connect the boost outputs to buck inputs.
4. Ensure J25 is shorted with jumper for the voltage feedback connection.
5. Open J30 and short J34 to set the IC in boost mode. R17 and R18 are used to set up the boost on/off threshold divided from boost input. With R17 = 130kΩ and R18 = 1MΩ, the boost will start to operate when VIN_BOOST+(J5) voltage

drops below 7V; and the boost will stop switching when boost input recovers to be above 10V.

6. Open J13 and J11, and short J12 to set up the boost output overvoltage protection. R24 and R25 are used to set up the boost output OVP threshold. With 1MΩ at R24 and 42.2kΩ at R25, the boost PWM will be turned off when the boost output voltage reaches 25V and recovers switching when it drops below 22V.
7. Leave all the other jumpers connectors open.
8. Short J14 to disable the IC prior to applying the power source to boost inputs.
9. Connect the power source to the boost inputs J5(VIN_BOOST+) and J6(GND). Connect the load terminals to the buck outputs J3(VOUT+) and J4(GND). Make sure the setup is correct prior to applying any power or load to the board.
10. Adjust the power source to 12V and turn it on.
11. Open J14 to enable the IC.
12. Verify the buck output voltage is 5V. Use the oscilloscope to monitor the buck phase node waveforms (J28) and the boost phase node waveforms (J17).
13. Adjust the input voltage down to 5V to start up the boost. Note the boost input voltage cannot be too low and it is limited by the current ratings of the boost switch and boost inductor. The boost input current will increase upon the decrease of boost input voltage. The input current should be estimated before turning the input voltage extremely low under heavy load (refer to the boost operation description section in the [datasheet](#) for more details).
14. The shutdown sequence must be: short J14 to shut down the IC first, then turn off the power source at the boost input. To turn off the power source (boost input) first with the circuits operating at boost mode could cause damage to the boost MOSFET and IC resulting from the current stress at boost switches and inductors. In designs using boost mode, the same shutdown sequence must be followed.

Application Note 1772

TABLE 1. CONNECTORS/TEST POINTS DESCRIPTIONS

TEST POINT	DESCRIPTION
J1	VIN+, positive terminal of buck inputs.
J2	GND, ground terminal of buck inputs.
J3	VOUT+, positive terminal of buck outputs.
J4	GND, ground terminal of buck outputs.
J5	VIN_BOOST+, positive terminal of boost inputs.
J6	GND, ground terminal of boost inputs.
J7	Mode setup connector. Connecting the MODE pin to GND will set the IC in forced PWM mode; leaving the MODE pin open or connected to VCC sets the IC to have PFM available under light load condition. The default PFM current threshold for the IC is 0.7A. R16 is a placeholder for a resistor to program the PFM current threshold.
J8	Test points used to monitor boost input. For monitoring purposes only. Do not short it with jumper.
J9	Test points used to monitor buck input. For monitoring purposes only. Do not short it with jumper.
J10	N/A. Leave open.
J11	With J11 shorted, VOUT+ is connected to AUXVCC for the switchover function. The IC switches over from main LDO to auxiliary LDO after VOUT is built-up.
J12	In boost buck mode, with J12 shorted, the AUXVCC pin monitors boost output voltage through R24 and R25 providing overvoltage protection.
J13	Use this connector to apply any voltage to AUXVCC as the AUXLDO input. Short it to ground when AUXVCC is not used.
J14	Use this connector to control IC ON/OFF.
J15	Test points used to monitor the FB pin. For monitoring purposes only. Do not short it with jumper.
J16	Use to set up switching frequency. With the FS pin connected to VCC or GND, or left open, the default frequency of the IC is 500kHz. R8 is a placeholder for a resistor to program frequency.
J17	Test points used to monitor the boost phase node. For monitoring purposes only. Do not short it with jumper.
J18	Use it to configure synchronization. Option 1: to apply external clock for the IC to be synchronized with. Option 2: to synchronize multiple ISL78200, simply connect those SYNC pins together.
J22	Test points used to monitor the boost output. For monitoring purposes only. Do not short it with jumper.
J23	Test points used to monitor the COMP pin. For monitoring purposes only. Do not short it with jumper.
J24	N/A. Leave open.
J25	Must short it with jumper to provide output feedback connection.
J26, J27	In boost buck configuration, short these connectors to connect boost outputs to buck inputs.
J28	Test points used to monitor the buck PHASE node waveforms. For monitoring purposes only. Do not short it with jumper.
J29	Use it to set up the overcurrent limit threshold. With the ILIMIT pin connected to VCC or GND or left open, the default OC threshold of the IC is 3.6A. R15 is a placeholder for a resistor to program the OC threshold.
J30, J34	Connectors to set up the boost operation. Option 1: to short J30, set the IC in non-boost mode (either synchronous or asynchronous buck mode). Option 2: to open J30 and short J34, set the IC in boost mode. A voltage higher than 0.2V on the EXT_BOOST pin before VCC POR ON latches the IC in boost buck mode at startup.
J31	VOUT_BOOST+, positive terminal of boost output.
J32	Test points used to monitor the LGATE. For monitoring purposes only. Do not short it with jumper.
J33	For asynchronous buck configuration; shorting it with jumper before IC startup will disable the low-side driver after IC startup.
J35	Shorting it with jumper will cause the IC's boost to always run.
J36	Test points used to monitor the buck output voltage. For monitoring purposes only. Do not short it with jumper.

Application Note 1772

TABLE 2. BILL OF MATERIALS

REF DES	PART NUMBER	QTY	DESCRIPTION	MANUFACTURER
C3	VARIOUS	1	CAP, SMD, 0603, 1.0 μ F, 16V, 10%, X7R, ROHS	VARIOUS
C19,C57	EEE-FK1K220P	2	CAP, SMD, 8X10.2, 22 μ F, 80V, 20%, ALUM.ELEC., ROHS	PANASONIC
C1	VARIOUS	1	CAP, SMD, 0805, 4.7 μ F, 10V, 10%, X7R, ROHS	VARIOUS
C2,C18, C22	VARIOUS	3	CAP, SMD, 1206, 2.2 μ F, 50V, 10%, X7R, ROHS	VARIOUS
C8	VARIOUS	1	CAP, SMD, 0603, 100pF, 50V, 5%, COG, ROHS	VARIOUS
C20	VARIOUS	1	CAP, SMD, 0603, 0.01 μ F, 16V, 10%, X7R, ROHS	VARIOUS
C16, C23	VARIOUS	2	CAP, SMD, 0603, 0.1 μ F, 50V, 10%, X7R, ROHS	VARIOUS
C4	VARIOUS	1	CAP, SMD, 0603, 0.022 μ F, 16V, 10%, X7R, ROHS	VARIOUS
C7	VARIOUS	1	CAP, SMD, 0603, 470pF, 50V, 10%, X7R, ROHS	VARIOUS
C9, C11, C26, C27, C28	DNP	0	CAP, SMD, 0603, DNP-PLACE HOLDER, ROHS	N/A
C5	VARIOUS	1	CAP, SMD, 1206, 10 μ F, 16V, 10%, X5R, ROHS	VARIOUS
C10	DNP	0	CAP, SMD, 1206, DNP-PLACE HOLDER, ROHS	N/A
C6	DNP	0	CAP, SMD, 1210, DNP-PLACE HOLDER, ROHS	N/A
C58	16SVPD82M	1	CAP-OSCON, SMD, 6.9x8.3, 82 μ F, 16V, 20%, 40m Ω , ROHS	SANYO
L1	DR125-100-R	1	COIL-PWR INDUCTOR, SMD, 12.5mm, 10 μ H, 20%, 5.35A, ROHS	COOPER/COILTRONICS
L2	DR125-6R8-R	1	COIL-PWR INDUCTOR, SMD, 12.5mm, 6.8 μ H, 20%, 6.64A, ROHS	COOPER/COILTRONICS
D1, D3	PDS360	2	DIODE-SCHOTTKY RECTIFIER, SMD, POWERDI5, 60V, 3A, ROHS	DIODES INC.
U1	ISL78200AVEZ	1	IC-2.5A SYNC BUCK/BOOST BUCK CONTROLLER, HTSSOP, ROHS	INTERSIL
Q5, Q6	SQS462EN	2	TRANSISTOR-MOS, N-CHANNEL, 8P, PWRPAK, 60V, 8A, ROHS	VISHAY
R6, R19	VARIOUS	2	RES, SMD, 0603, 0 Ω ,1/10W, ROHS	VARIOUS
R18, R24	VARIOUS	2	RES, SMD, 0603, 1M, 1/10W, 1%, ROHS	VARIOUS
R17	VARIOUS	1	RES, SMD, 0603, 130k, 1/10W, 1%, ROHS	VARIOUS
R3	VARIOUS	1	RES, SMD, 0603, 232k, 1/10W, 1%, ROHS	VARIOUS
R7	VARIOUS	1	RES, SMD, 0603, 33.2k, 1/10W, 1%, ROHS	VARIOUS
R25	VARIOUS	1	RES,SMD,0603, 42.2k, 1/10W, 1%, ROHS	VARIOUS
R4	VARIOUS	1	RES, SMD, 0603, 44.2k, 1/10W, 1%, ROHS	VARIOUS
R5, R20, R23	VARIOUS	3	RES, SMD, 0603, 5.11k, 1/10W, 1%, ROHS	VARIOUS
R2	VARIOUS	1	RES, SMD, 0603, 51.1k, 1/10W, 1%, ROHS	VARIOUS
R8, R9, R15, R16	DNP	0	RES, SMD, 0603, DNP-PLACE HOLDER, ROHS	N/A
R1, R26	DNP	0	RES, SMD, 0805, DNP-PLACE HOLDER, ROHS	N/A
D2	DNP	0	DO NOT POPULATE OR PURCHASE	N/A

ISL78200EVAL1 Schematic

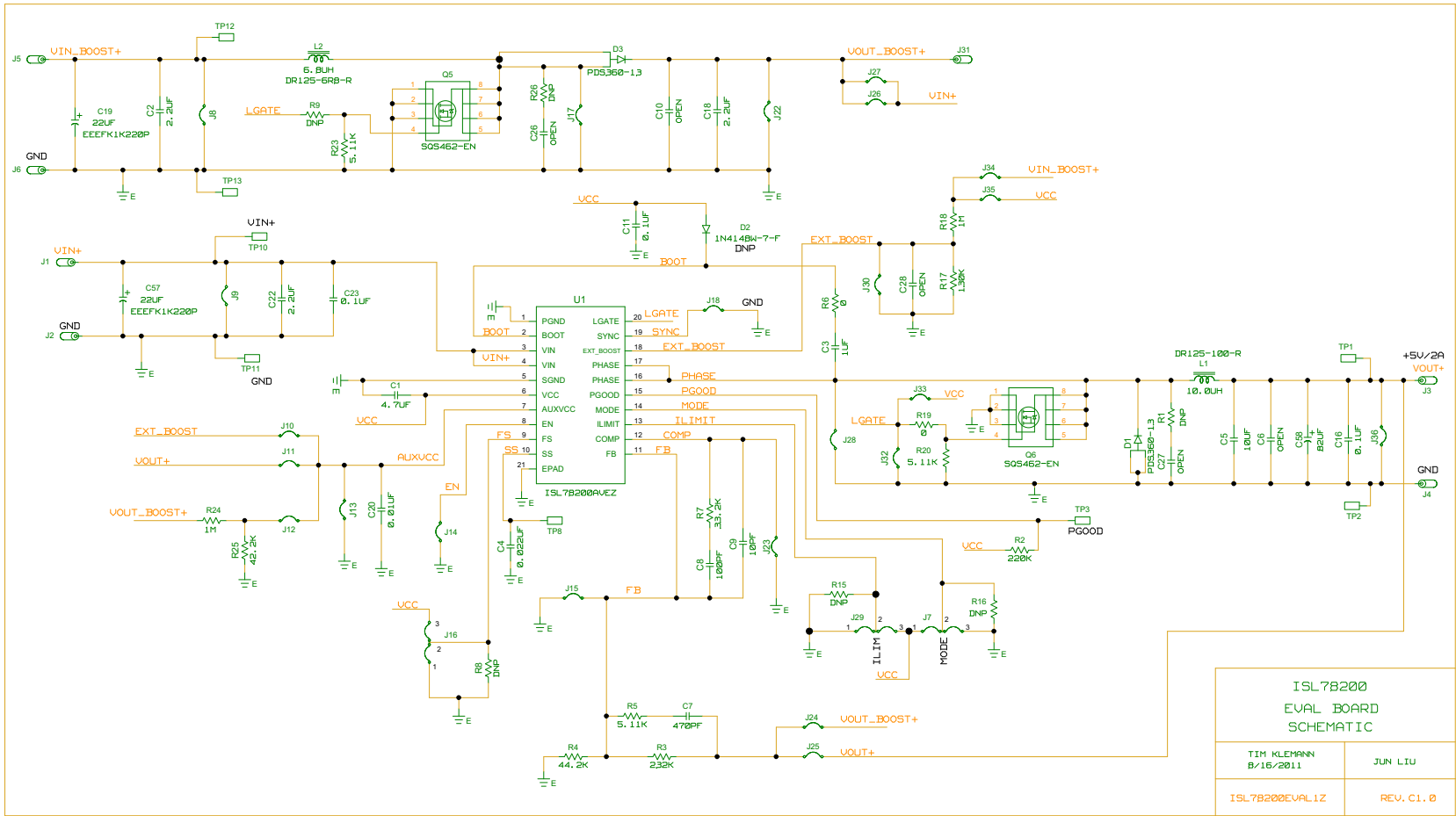

FIGURE 1. ISL78200EVAL1Z BOARD SCHEMATIC

ISL78200 EVAL BOARD SCHEMATIC	
TIM KLEMMANN 8/16/2011	JUN LIU
ISL78200EVAL1Z	REV. C1. 0

Board Layouts

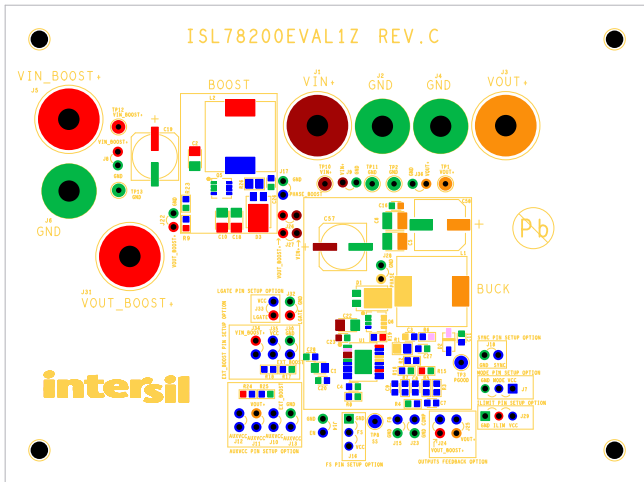

FIGURE 2. TOP COMPONENTS SILKSCREEN

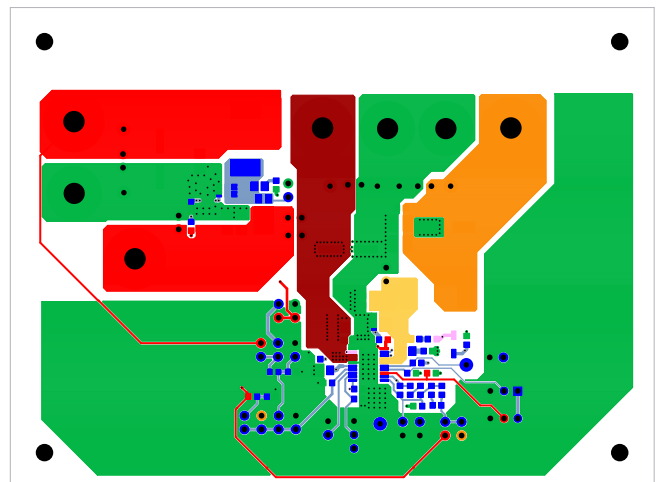

FIGURE 3. TOP LAYER

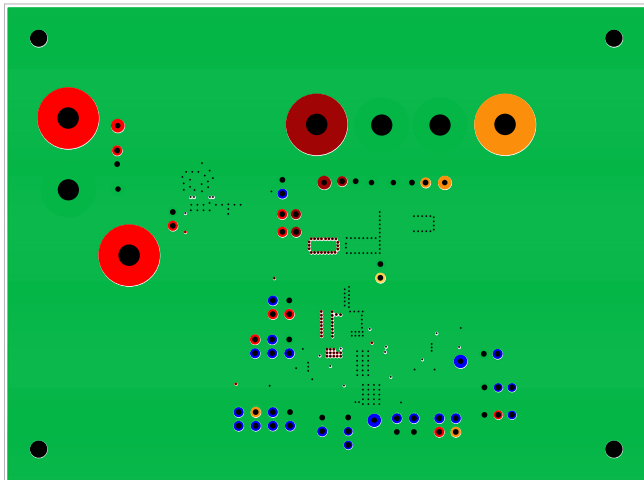

FIGURE 4. 2nd LAYER

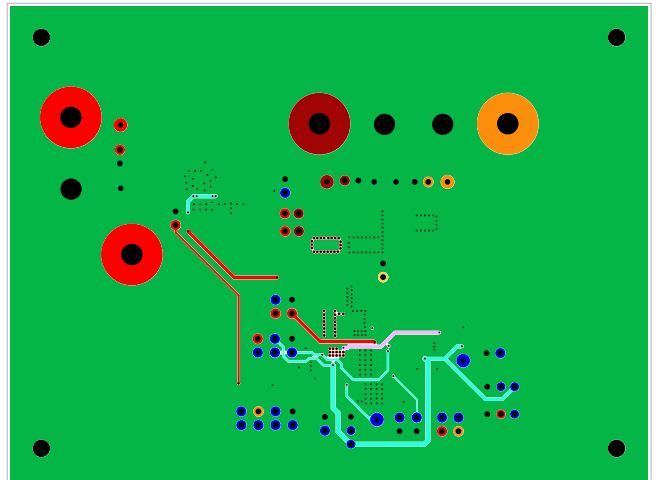

FIGURE 5. 3rd LAYER

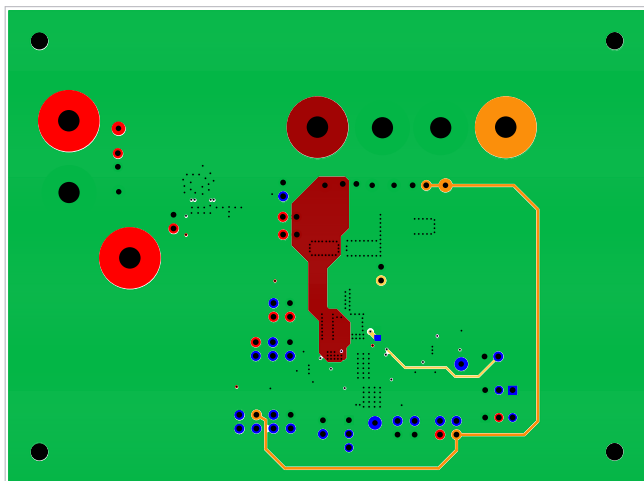

FIGURE 6. BOTTOM LAYER

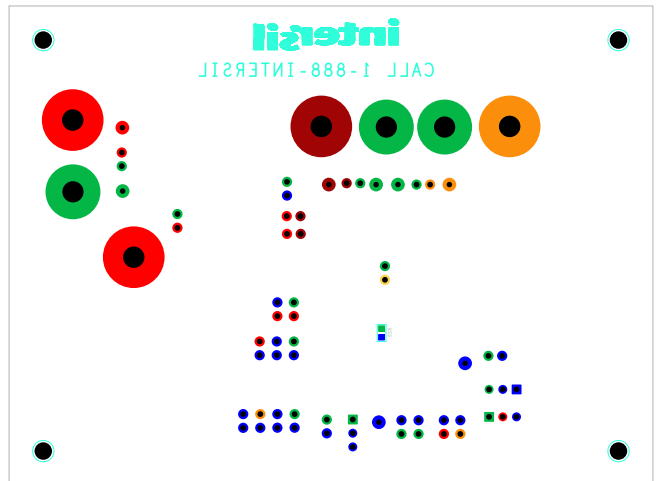

FIGURE 7. BOTTOM COMPONENTS SILKSCREEN

Board Layouts (Continued)

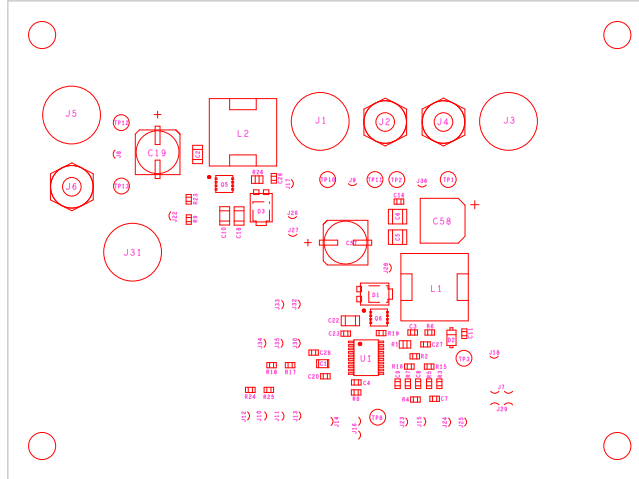

FIGURE 8. TOP COMPONENT ASSEMBLY

Intersil Corporation reserves the right to make changes in circuit design, software and/or specifications at any time without notice. Accordingly, the reader is cautioned to verify that the Application Note or Technical Brief is current before proceeding.

For information regarding Intersil Corporation and its products, see www.intersil.com