

ISL8107EVAL2Z

Evaluation Board

AN1459  
Rev 0.00  
Jun 9, 2009

The ISL8107 is a single-phase PWM controller that operates from 9V to 75V bias supply voltage. The PWM controller drives an external high-side N-Channel MOSFET in a non-synchronous buck converter topology. The ISL8107 features input voltage feed-forward compensation and overcurrent protection, etc. For a more detailed description of the ISL8107 functionality, refer to the ISL8107 Data Sheet <http://www.intersil.com/data/fn/fn6605.pdf>.

**The ISL8107EVAL2Z Reference Design**

The ISL8107EVAL2Z evaluation board is designed to meet the output voltage and current specifications shown in Table 1. Schematic, bill of materials, and layout plots are included.

TABLE 1. ISL8107EVAL2Z DESIGN PARAMETERS

PARAMETER	MIN	TYP	MAX
Input Voltage (V <sub>IN</sub> )	18V	48V	75V
Output Voltage (V <sub>OUT</sub> )		12V	
Output Voltage Ripple		30mV	
Continuous Load Current			5A
Switching Frequency		200kHz	

**Quick Start Evaluation**

Figure 1 shows a photograph of the ISL8107EVAL2Z board.



FIGURE 1. ISL8107EVAL2Z

**Circuit Setup**

The input supply of the power stage can be connected to the terminals P5 (V<sub>IN</sub>) and P6 (PGND). For single supply application, the ISL8107's bias supply can be tied to V<sub>IN</sub> through J1 with shunt between pins 2 and 3. When using separate supplies, provide the ISL8107 bias voltage through P1 (VBIAS) with J1's shunt between pins 1 and 2. The load can be connected to terminal P7 (V<sub>OUT</sub>) and P8 (PGND). TP3 and TP4 can be used for DMM to measure the output voltage. Enabling and disabling the controller can be done through the toggle switch, SW1.

**ISL8107EVAL2Z Performance**

**Start-Up**

Figure 2 shows the start-up waveforms of the ISL8107EVAL2Z. Upon the VCC and VFF exceeding their rising POR thresholds, the ISL8107 provides initially 2µA to charge the soft-start capacitor, C<sub>SS</sub>, connected to the ENSS pin. If the voltage at this pin is allowed to rise (the toggle switch, SW1, at ON position), the voltage on ENSS pin will ramp-up with at a slope determined by the 2µA current and the value of the soft-start capacitor. When the voltage at ENSS reaches 0.77V, the oscillator circuit is active, and generates sawtooth waveform. At the same time, the soft-start current is increased to 33µA; the ENSS voltage then ramps up at a faster rate. The UGATE starts switching when the ENSS voltage reaches 1.4V (Typ).

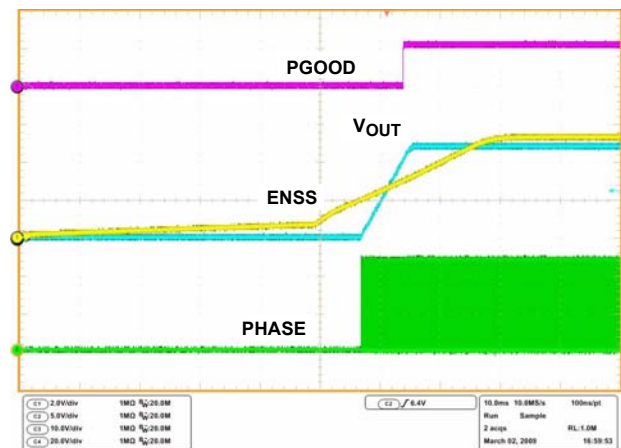

FIGURE 2. START-UP WAVEFORMS

**Output Voltage Ripple**

Figure 3 shows the ripple voltage on the output of the regulator at 5A load current.

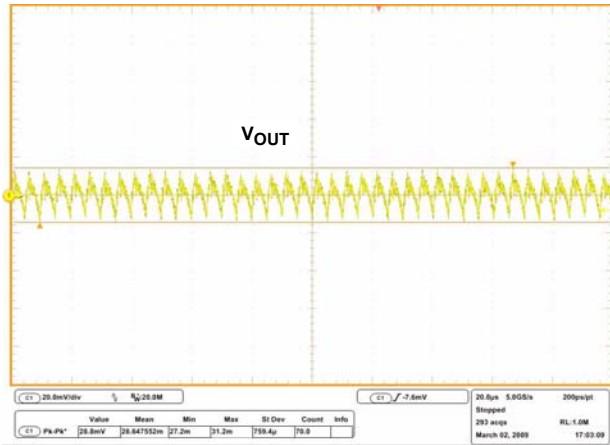

FIGURE 3. OUTPUT VOLTAGE RIPPLE @ I<sub>OUT</sub> = 5A

**Transient Responses**

Figures 4, 5, and 6 show the response of the output when subjected to transient loading from 1A to 5A at 1A/μs (within continuous conduction mode).

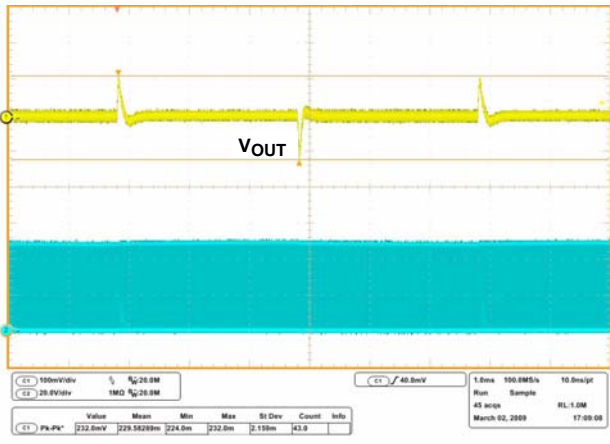

FIGURE 4. OUTPUT TRANSIENT

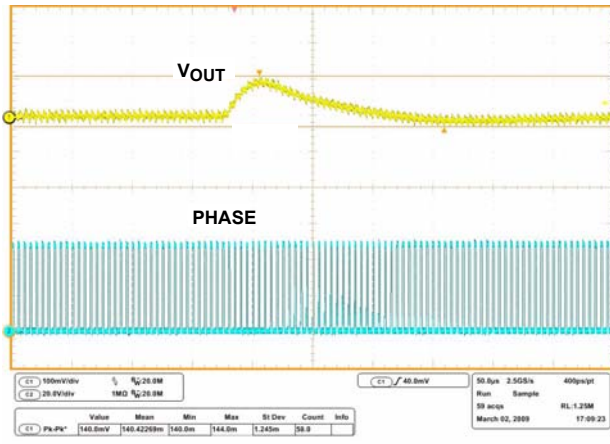

FIGURE 5. OUTPUT TRANSIENT

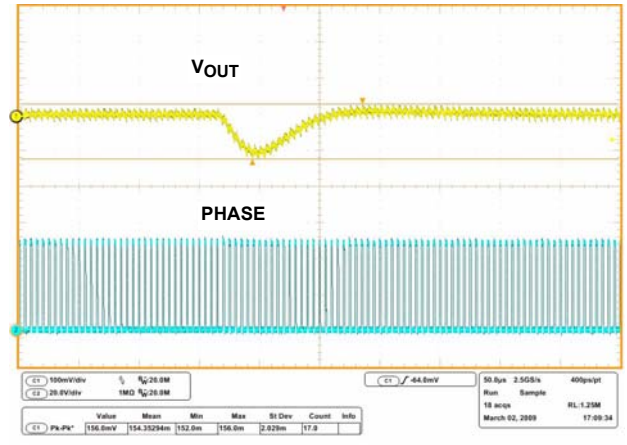

FIGURE 6. OUTPUT TRANSIENT

Figure 7 shows the response of the output when subjected to transient loading from 0.1A to 5A at 1A/μs (transition between continuous conduction mode and discontinuous conduction mode).

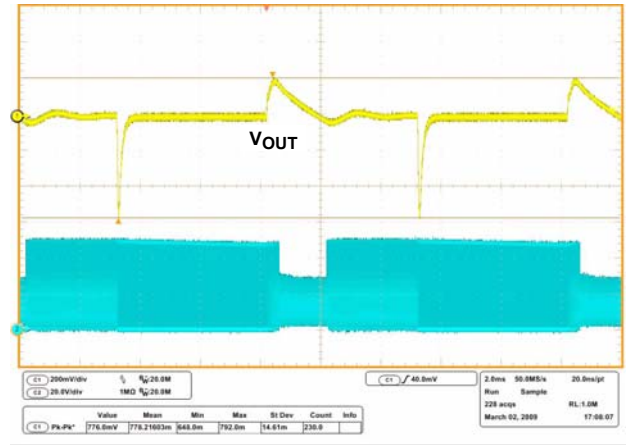

FIGURE 7. OUTPUT TRANSIENT

**Efficiency and Line Regulation**

The efficiency and the line regulation of the evaluation board with various input voltages are shown in Figures 8 and 9, respectively.

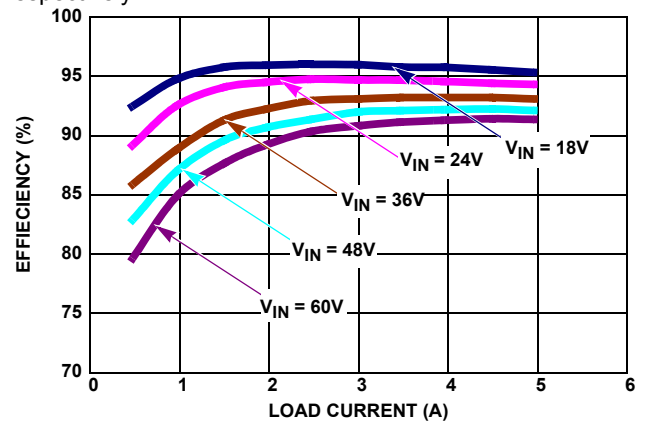

FIGURE 8. CONVERTER EFFICIENCY (V<sub>OUT</sub> = 12V)

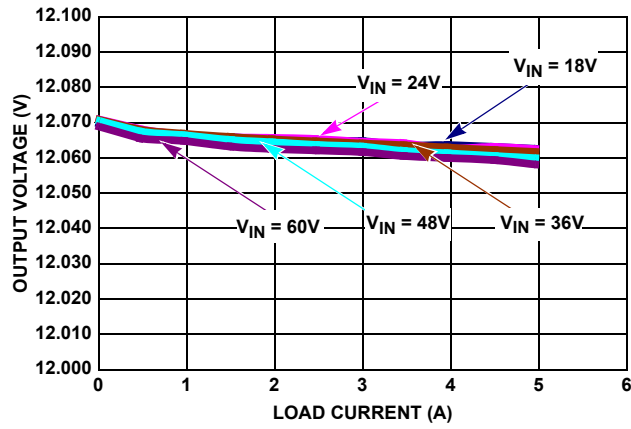
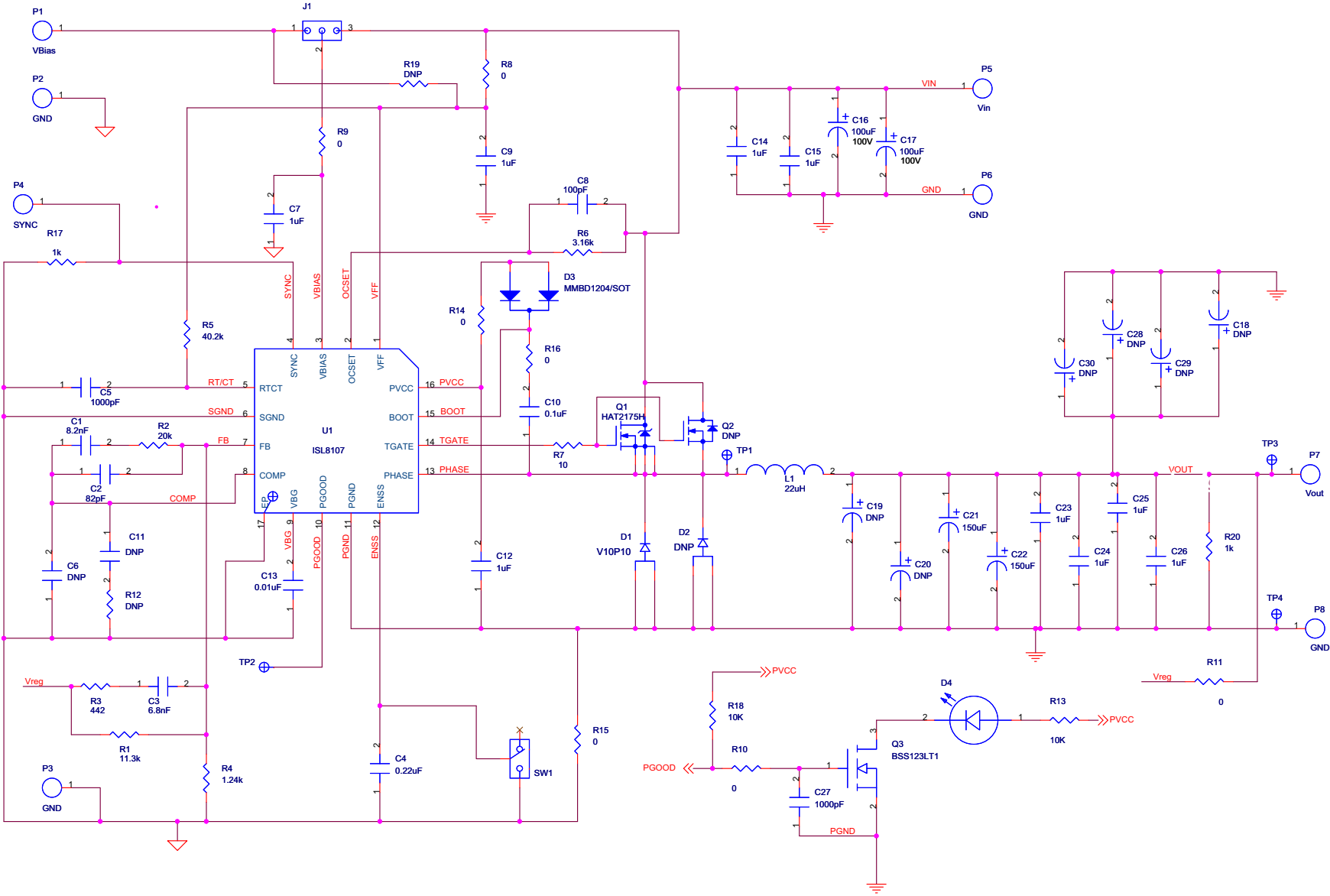

FIGURE 9. LINE REGULATION FOR V<sub>OUT</sub> = 12V

# ISL8107EVAL2Z Schematic



**Bill of Materials**

REFERENCE	QTY	PART NUMBER	DESCRIPTION	PACKAGE	VENDOR
U1	1	ISL8107IRZ	Single PWM Controller	16 Ld QFN	Intersil
Q1	1	HAT2175	100V N-Channel MOSFET	LFPAK	Renesas
Q3	1	BSS123LT1G	N-Channel MOSFET, 0.17A	SOT-23	On Semi.
D1	1	V10P10	100V Schottky Diode Rectifier	TO-277A	Vishay
D3	1	MMBD1204	100V Ultrafast Diode	SOT-23	Fairchild
D4	1	597-3311	LED Green	SMD1206	DIALIGHT
L1	1	HC9-220-R	22 $\mu$ H Power Inductor	SMD 12.9x13.2	Coiltronics
Q2, D2	0	DNP			
<b>CAPACITORS</b>					
C1	1		8200pF, 50V, X7R, 10%, Ceramic Capacitor	0603	Various
C2	1		82pF, 50V, COG, 10%, Ceramic Capacitor	0603	Various
C3	1		6800pF, 50V, X7R, 10%, Ceramic Capacitor	0603	Various
C4	1		0.22 $\mu$ F, 16V, X7R, 10%, Ceramic Capacitor	0603	Various
C5	1	GRM2195C2A102JA01D	1000pF, 100V, COG, 5%, Ceramic Capacitor	0805	Murata
C7, C9, C14, C15	4		1 $\mu$ F, 100V, X7R, 10%, Ceramic Capacitor	1210	Various
C8	1		100pF, 50V, COG, 10%, Ceramic Capacitor	0603	Various
C10	1		0.1 $\mu$ F, 50V, X7R, 10%, Ceramic Capacitor	0603	Various
C12, C23, C24, C25, C26	5		1 $\mu$ F, 25V, X5R, 10%, Ceramic Capacitor	0805	Various
C13	1		0.01 $\mu$ F, 50V, X7R, 10%, Ceramic Capacitor	0603	Various
C16, C17	2	100ME100PX	100 $\mu$ F, 100V, Aluminum Electrolytic Capacitor	RAD 12.5x20	Sanyo
C21, C22	2	20SEQP150M	150 $\mu$ F, 20V, OSCON Capacitor	RAD 10x13	Sanyo
C27	1		1000pF, 50V, X7R, 10%, Ceramic Capacitor	0603	Various
C6, C11, C18, C19, C20, C28, C29, C30	0	DNP			
<b>RESISTORS</b>					
R1	1		Resistor, 11.3k $\Omega$ , 1%, 1/10W	0603	Various
R2	1		Resistor, 20k $\Omega$ , 1%, 1/10W	0603	Various
R3	1		Resistor, 442 $\Omega$ , 1%, 1/10W	0603	Various
R4	1		Resistor, 1.24k $\Omega$ , 1%, 1/10W	0603	Various
R5	1		Resistor, 40.2k $\Omega$ , 1%, 1/10W	0603	Various
R6	1		Resistor, 3.16k $\Omega$ , 1%, 1/10W	0603	Various
R7	1		Resistor, 10 $\Omega$ , 1%, 1/10W	0603	Various
R8, R9, R10, R11, R14, R15, R16	7		0 $\Omega$ Resistor, 1/10W	0603	Various
R13, R18	2		Resistor, 10k $\Omega$ , 5%, 1/10W	0603	Various
R17	1		Resistor, 1k $\Omega$ , 1%, 1/10W	0603	Various
R20	1		Resistor, 1k $\Omega$ , 1%, 1W	2512	Various
R12, R19	0	DNP			
<b>OTHERS</b>					
J1	1	68000-236-1X3	Connector Header		BERG/FCI
SW1	1	GT11MSCKE	SMD Toggle Switch		C&K
P1 through P8	8	1514-2	Turret Post		Keystone

**ISL8107EVAL2Z Layout**

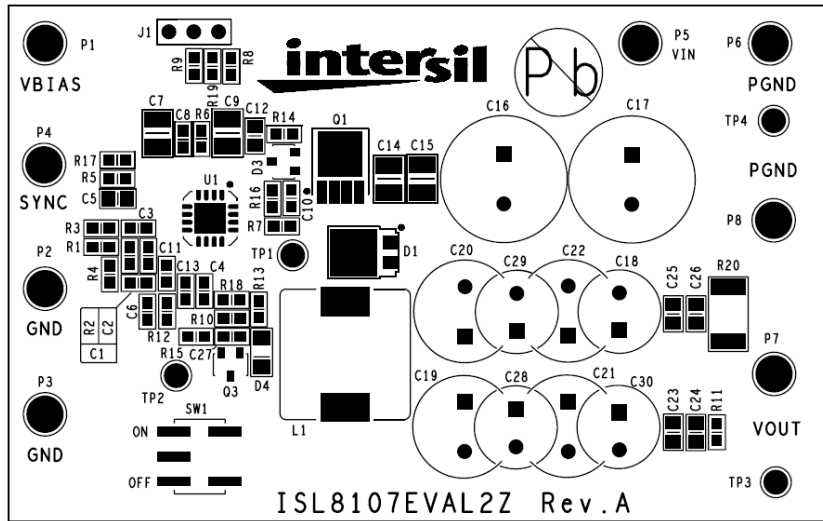

FIGURE 10. TOP SILK SCREEN

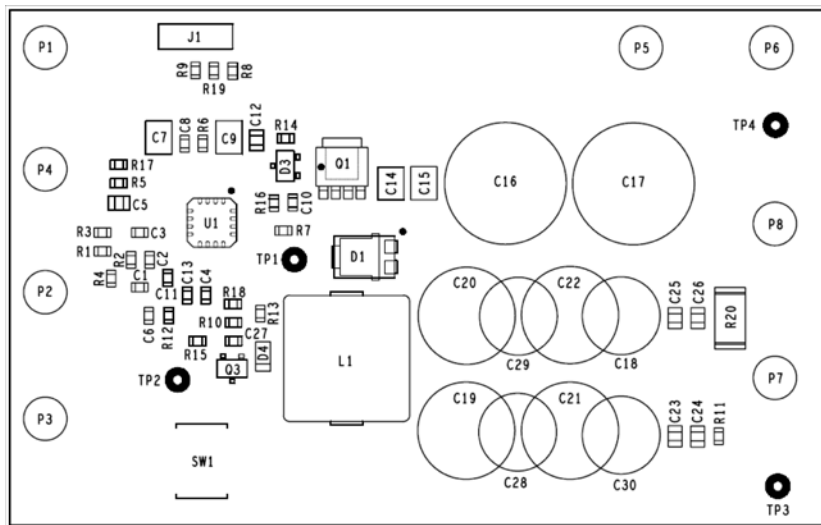

FIGURE 11. TOP ASSEMBLY

**ISL8107EVAL2Z Layout** (Continued)

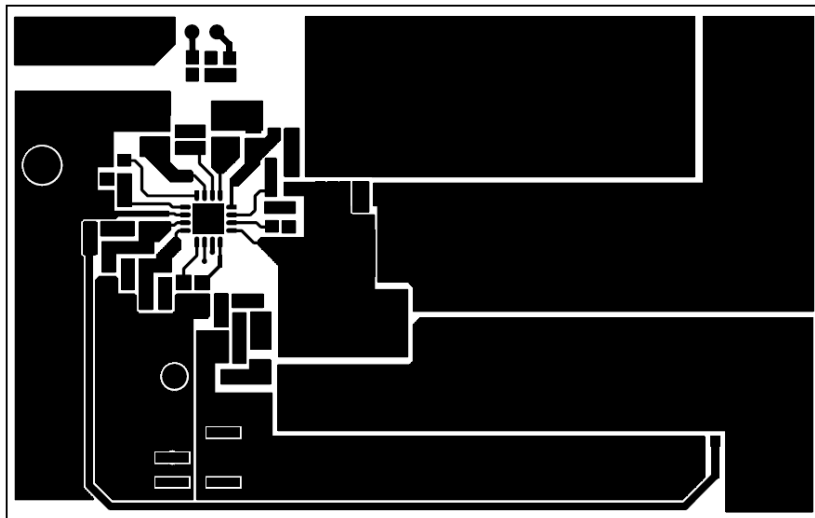

FIGURE 12. TOP LAYER

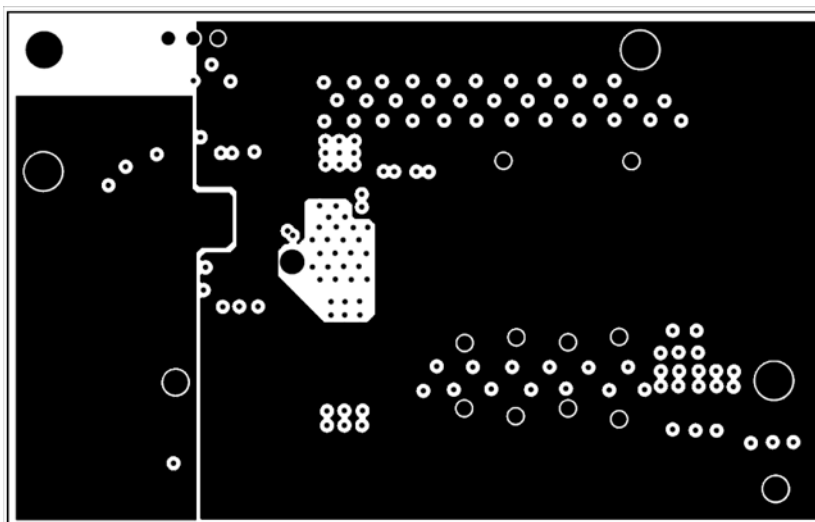

FIGURE 13. LAYER 2

**ISL8107EVAL2Z Layout** (Continued)

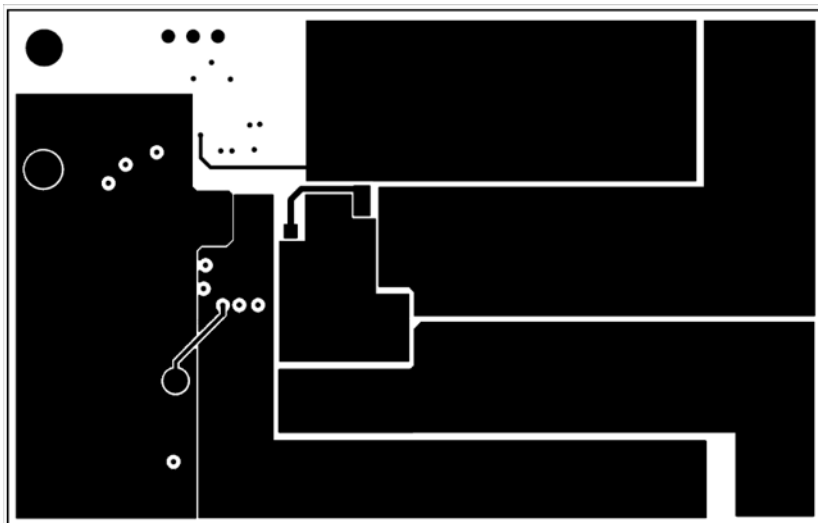

FIGURE 14. LAYER 3

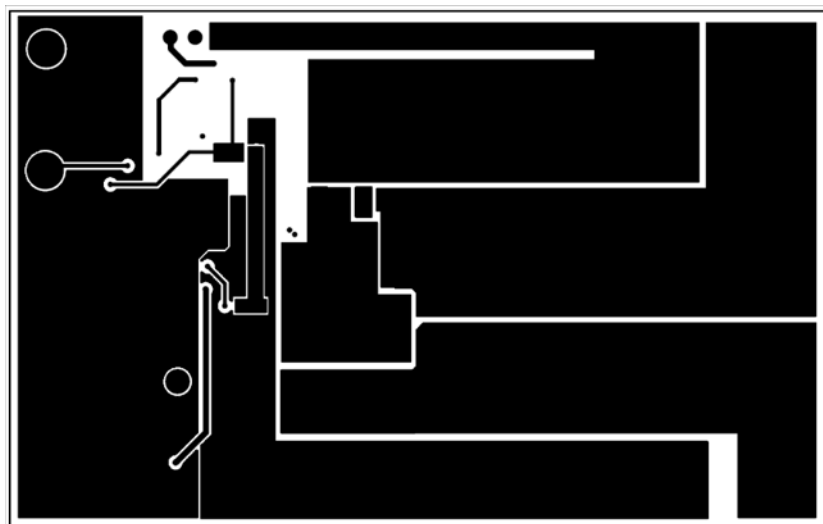

FIGURE 15. BOTTOM LAYER



**ISL8107EVAL2Z Layout (Continued)**

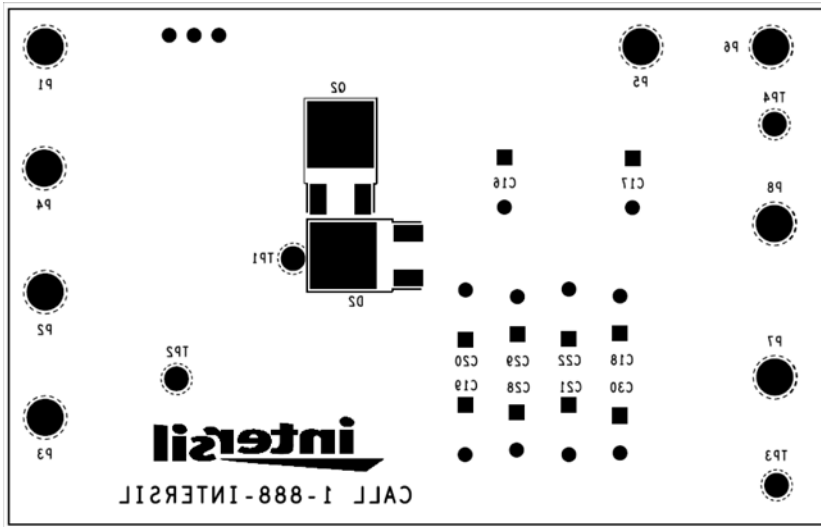

FIGURE 16. BOTTOM SILK SCREEN

## Notice

1. Descriptions of circuits, software and other related information in this document are provided only to illustrate the operation of semiconductor products and application examples. You are fully responsible for the incorporation or any other use of the circuits, software, and information in the design of your product or system. Renesas Electronics disclaims any and all liability for any losses and damages incurred by you or third parties arising from the use of these circuits, software, or information.
2. Renesas Electronics hereby expressly disclaims any warranties against and liability for infringement or any other claims involving patents, copyrights, or other intellectual property rights of third parties, by or arising from the use of Renesas Electronics products or technical information described in this document, including but not limited to, the product data, drawings, charts, programs, algorithms, and application examples.
3. No license, express, implied or otherwise, is granted hereby under any patents, copyrights or other intellectual property rights of Renesas Electronics or others.
4. You shall not alter, modify, copy, or reverse engineer any Renesas Electronics product, whether in whole or in part. Renesas Electronics disclaims any and all liability for any losses or damages incurred by you or third parties arising from such alteration, modification, copying or reverse engineering.
5. Renesas Electronics products are classified according to the following two quality grades: "Standard" and "High Quality". The intended applications for each Renesas Electronics product depends on the product's quality grade, as indicated below.  
"Standard": Computers; office equipment; communications equipment; test and measurement equipment; audio and visual equipment; home electronic appliances; machine tools; personal electronic equipment; industrial robots; etc.  
"High Quality": Transportation equipment (automobiles, trains, ships, etc.); traffic control (traffic lights); large-scale communication equipment; key financial terminal systems; safety control equipment; etc.  
Unless expressly designated as a high reliability product or a product for harsh environments in a Renesas Electronics data sheet or other Renesas Electronics document, Renesas Electronics products are not intended or authorized for use in products or systems that may pose a direct threat to human life or bodily injury (artificial life support devices or systems; surgical implantations; etc.), or may cause serious property damage (space system; undersea repeaters; nuclear power control systems; aircraft control systems; key plant systems; military equipment; etc.). Renesas Electronics disclaims any and all liability for any damages or losses incurred by you or any third parties arising from the use of any Renesas Electronics product that is inconsistent with any Renesas Electronics data sheet, user's manual or other Renesas Electronics document.
6. When using Renesas Electronics products, refer to the latest product information (data sheets, user's manuals, application notes, "General Notes for Handling and Using Semiconductor Devices" in the reliability handbook, etc.), and ensure that usage conditions are within the ranges specified by Renesas Electronics with respect to maximum ratings, operating power supply voltage range, heat dissipation characteristics, installation, etc. Renesas Electronics disclaims any and all liability for any malfunctions, failure or accident arising out of the use of Renesas Electronics products outside of such specified ranges.
7. Although Renesas Electronics endeavors to improve the quality and reliability of Renesas Electronics products, semiconductor products have specific characteristics, such as the occurrence of failure at a certain rate and malfunctions under certain use conditions. Unless designated as a high reliability product or a product for harsh environments in a Renesas Electronics data sheet or other Renesas Electronics document, Renesas Electronics products are not subject to radiation resistance design. You are responsible for implementing safety measures to guard against the possibility of bodily injury, injury or damage caused by fire, and/or danger to the public in the event of a failure or malfunction of Renesas Electronics products, such as safety design for hardware and software, including but not limited to redundancy, fire control and malfunction prevention, appropriate treatment for aging degradation or any other appropriate measures. Because the evaluation of microcomputer software alone is very difficult and impractical, you are responsible for evaluating the safety of the final products or systems manufactured by you.
8. Please contact a Renesas Electronics sales office for details as to environmental matters such as the environmental compatibility of each Renesas Electronics product. You are responsible for carefully and sufficiently investigating applicable laws and regulations that regulate the inclusion or use of controlled substances, including without limitation, the EU RoHS Directive, and using Renesas Electronics products in compliance with all these applicable laws and regulations. Renesas Electronics disclaims any and all liability for damages or losses occurring as a result of your noncompliance with applicable laws and regulations.
9. Renesas Electronics products and technologies shall not be used for or incorporated into any products or systems whose manufacture, use, or sale is prohibited under any applicable domestic or foreign laws or regulations. You shall comply with any applicable export control laws and regulations promulgated and administered by the governments of any countries asserting jurisdiction over the parties or transactions.
10. It is the responsibility of the buyer or distributor of Renesas Electronics products, or any other party who distributes, disposes of, or otherwise sells or transfers the product to a third party, to notify such third party in advance of the contents and conditions set forth in this document.
11. This document shall not be reprinted, reproduced or duplicated in any form, in whole or in part, without prior written consent of Renesas Electronics.
12. Please contact a Renesas Electronics sales office if you have any questions regarding the information contained in this document or Renesas Electronics products.  
(Note 1) "Renesas Electronics" as used in this document means Renesas Electronics Corporation and also includes its directly or indirectly controlled subsidiaries.  
(Note 2) "Renesas Electronics product(s)" means any product developed or manufactured by or for Renesas Electronics.

(Rev.4.0-1 November 2017)



### SALES OFFICES

Renesas Electronics Corporation

<http://www.renesas.com>

Refer to "<http://www.renesas.com/>" for the latest and detailed information.

#### Renesas Electronics America Inc.

1001 Murphy Ranch Road, Milpitas, CA 95035, U.S.A.  
Tel: +1-408-432-8888, Fax: +1-408-434-5351

#### Renesas Electronics Canada Limited

9251 Yonge Street, Suite 8309 Richmond Hill, Ontario Canada L4C 9T3  
Tel: +1-905-237-2004

#### Renesas Electronics Europe Limited

Dukes Meadow, Millboard Road, Bourne End, Buckinghamshire, SL8 5FH, U.K  
Tel: +44-1628-651-700, Fax: +44-1628-651-804

#### Renesas Electronics Europe GmbH

Arcadiastrasse 10, 40472 Düsseldorf, Germany  
Tel: +49-211-6503-0, Fax: +49-211-6503-1327

#### Renesas Electronics (China) Co., Ltd.

Room 1709 Quantum Plaza, No.27 ZhichunLu, Haidian District, Beijing, 100191 P. R. China  
Tel: +86-10-8235-1155, Fax: +86-10-8235-7679

#### Renesas Electronics (Shanghai) Co., Ltd.

Unit 301, Tower A, Central Towers, 555 Langao Road, Putuo District, Shanghai, 200333 P. R. China  
Tel: +86-21-2226-0888, Fax: +86-21-2226-0999

#### Renesas Electronics Hong Kong Limited

Unit 1601-1611, 16/F., Tower 2, Grand Century Place, 193 Prince Edward Road West, Mongkok, Kowloon, Hong Kong  
Tel: +852-2265-6688, Fax: +852 2886-9022

#### Renesas Electronics Taiwan Co., Ltd.

13F, No. 363, Fu Shing North Road, Taipei 10543, Taiwan  
Tel: +886-2-8175-9600, Fax: +886 2-8175-9670

#### Renesas Electronics Singapore Pte. Ltd.

80 Bendemeer Road, Unit #06-02 Hyflux Innovation Centre, Singapore 339949  
Tel: +65-6213-0200, Fax: +65-6213-0300

#### Renesas Electronics Malaysia Sdn.Bhd.

Unit 1207, Block B, Menara Amcorp, Amcorp Trade Centre, No. 18, Jln Persiaran Barat, 46050 Petaling Jaya, Selangor Darul Ehsan, Malaysia  
Tel: +60-3-7955-9390, Fax: +60-3-7955-9510

#### Renesas Electronics India Pvt. Ltd.

No.777C, 100 Feet Road, HAL 2nd Stage, Indiranagar, Bangalore 560 038, India  
Tel: +91-80-67208700, Fax: +91-80-67208777

#### Renesas Electronics Korea Co., Ltd.

17F, KAMCO Yangjae Tower, 262, Gangnam-daero, Gangnam-gu, Seoul, 06265 Korea  
Tel: +82-2-558-3737, Fax: +82-2-558-5338