

ISL8500EVAL2Z

2A Negative Output Buck-Boost Converter

AN1500

Rev 0.00

November 19, 2009

Description

The ISL8500EVAL2Z REV A kit is intended for use by individuals with requirements for Point-of-Load applications sourcing from 9V to 14V. The ISL8500EVAL2Z evaluation board is used to demonstrate the performance of the ISL8500 standard buck-boost regulator.

The ISL8500 is offered in a 4mmx3mm 12 Ld DFN package with 1mm maximum height. The complete converter occupies less than 0.385in² area.

Features

- Standard Buck Controller with Integrated Switching Power MOSFET
- Integrated Boot Diode
- Input Voltage Range
 - Variable 9V to 14V
- PWM Output Voltage Adjustable from -12.6V to -0.6V with Continuous Output Current up to 2A
- Voltage Mode Control with Voltage Feed Forward
- Fixed 500kHz Switching Frequency
- Externally Adjustable Soft-Start Time
- Output Undervoltage Protection
- PGOOD Output
- Overcurrent Protection
- Thermal Overload Protection
- Internal 5V LDO regulator

Applications

- General Purpose
- Hand-Held Instruments

What's Inside

The Evaluation Board Kit contains the following materials:

- The ISL8500 EVAL2Z REV A Board
- The ISL8500 Datasheet
- This EVAL KIT Document

Recommended Equipment

The following materials are recommended to perform testing:

- 0V to 15V power supply with at least 5A source current capability, battery, notebook AC adapter
- One electronic load capable of sinking current up to 5A

- Digital Multimeters (DMMs)
- 100MHz quad-trace oscilloscope
- Signal generator

Quick Set-up Guide

1. Ensure that the circuit is correctly connected to the supply and loads prior to applying any power.
2. Connect the bias supply to V_{IN}, the plus terminal to TP1 (VIN) and the negative return to TP2 (GND).
3. Verify that SW1 is on ENABLE.
4. Turn on the power supply.
5. Verify the PG is on and the output voltage is 2.5V for V_{OUT}(TP3).

Evaluating the Other Output Voltage

The ISL8500EVAL kit outputs are preset to -12V; however, it can be programmed using resistor dividers using Equation 1:

$$R_4 = \frac{R_2 \cdot 0.6V}{|V_{OUT}| - 0.6V} \quad (\text{EQ. 1})$$

The output voltage programming resistor R₂ will depend on on the feedback resistor R₁, as referred to in Figure 1. The value of R₁ is typically between 1kΩ and 10kΩ. If the output voltage desired is 0.6V, then R₂ is left opened.

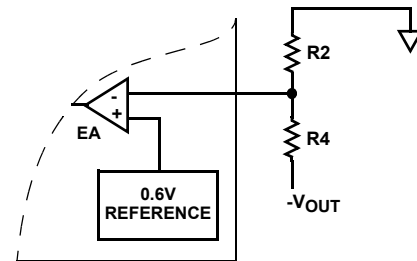
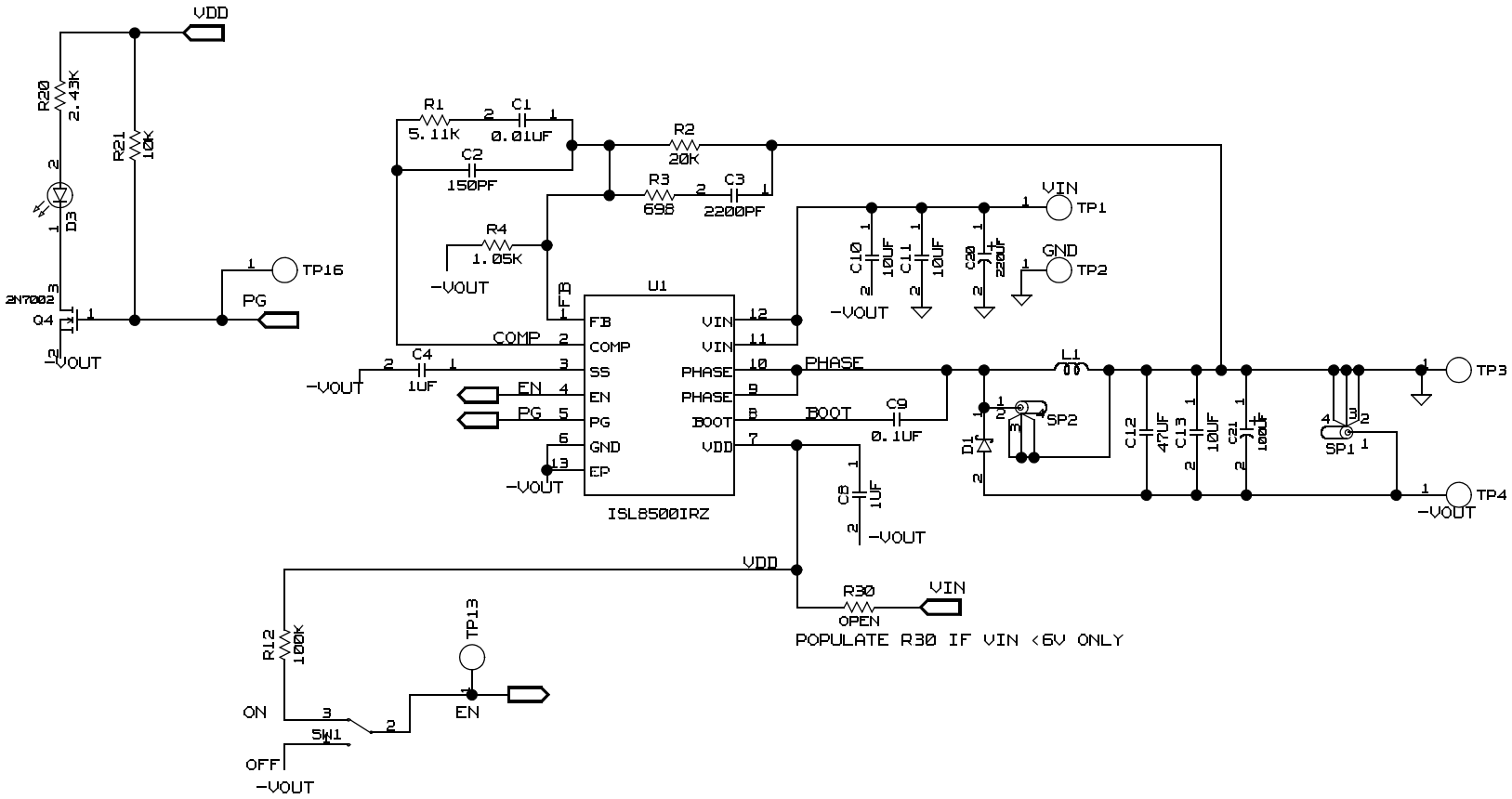

FIGURE 1. EXTERNAL RESISTOR DIVIDER

TABLE 1. SWITCH 1 SETTINGS

SW1	ENABLE	OPERATING MODE
1	SW1	Enable or disable the buck controller

Schematic



ISL8500EVAL2Z Bill of Materials

PART NUMBER	QTY	UNITS	REFERENCE DESIGNATOR	DESCRIPTION	MFTR	MANUFACTURER PART
ISL8500EVAL2ZREVAPCB	1	ea		PWB-PCB, ISL8500EVAL2Z, REVA, ROHS	TITAN	ISL8500EVAL2ZREVAPCB
H1044-00103-50V10-T	1	ea	C1	CAP, SMD, 0402, 10nF, 50V, 10%, X7R, ROHS	PANASONIC	ECJ-0EB1H103K
H1065-00106-25V10-T	2	ea	C10, C11	CAP, SMD, 1206, 10µF, 25V, 10%, X5R, ROHS	VENKEL	C1206X5R250-106KNE
DNP	0	ea	C13, C20, C21	DO NOT POPULATE OR PURCHASE		
H1082-00476-16V20-T	1	ea	C12	CAP, SMD, 1210, 47µF, 16V, 20%, X5R, ROHS	TDK	C3225X5R1C476M
					PANASONIC	ECJ-4YB1E476M
					AVX	1210YD476MAT
H1044-00151-50V5-T	1	ea	C2	CAP, SMD, 0402, 150pF, 50V, 5%, NPO, ROHS	VENKEL	C0402COG500-151JNE
H1044-00222-50V10-T	1	ea	C3	CAP, SMD, 0402, 2200pF, 50V, 10%, X7R, ROHS	PANASONIC	ECJ-0EB1H222K
					VENKEL	C0402X74500-471KNE
H1045-00105-6R3V10-T	2	ea	C4,C8	CAP, SMD, 0603, 1µF, 6.3V, 10%, X5R, ROHS	PANASONIC	ECJ1VB0J105K
C1608X7R1H104K-T	1	ea	C9	CAPACITOR, SMD, 0603, 0.10µF, 50V, 10%, X7R	TDK	C1608X7R1H104K
B340LB-13-F-T	1	ea	D1	DIODE-SCHOTTKY SMD, SMB, 2P, 40V, 3A LOW VF, ROHS	DIODES INC.	B340LB-13-F
DNP	0	ea	D3	DO NOT POPULATE OR PURCHASE		
IHLP2525CZRZ220M01	1	ea	L1	COIL-PWR INDUCTOR, SMD, 6.9x6.5, 22µH, 20%, 2.5A, ROHS	VISHAY	IHLP2525CZRZ220M01
DNP	0	ea	Q4	DO NOT POPULATE OR PURCHASE		
H2510-05111-1/16W1-T	1	ea	R1	RES, SMD, 0402, 5.11k, 1/16W, 1%, TF, ROHS	PANASONIC	ERJ-2RKF5111X
					VENKEL	CR0402-16W-5111FT
H2510-01003-1/16W1-T	1	ea	R12	RES, SMD, 0402, 100k, 1/16W, 1%, TF, ROHS	PANASONIC	ERJ2RKF1003
H2510-02002-1/16W1-T	1	ea	R2	RES, SMD, 0402, 20k, 1/16W, 1%, TF, ROHS	PANASONIC	ERJ-2RKF2002
					VENKEL	CR0402-16W-2002FT
DNP	0	ea	R20	DO NOT POPULATE OR PURCHASE		
H2511-01002-1/10W1-T	1	ea	R21	RES, SMD, 0603, 10k, 1/10W, 1%, TF, ROHS	KOA	RK73H1JT1002F
					VENKEL	CR0603-10W-1002FT
H2510-06980-1/16W1-T	1	ea	R3	RES, SMD, 0402, 698Ω, 1/16W, 1%, TF, ROHS	PANASONIC	ERJ-2RKF6980X
					VENKEL	CR0402-16W-6980-FT

ISL8500EVAL2Z Bill of Materials (Continued)

PART NUMBER	QTY	UNITS	REFERENCE DESIGNATOR	DESCRIPTION	MFTR	MANUFACTURER PART
H2511-DNP	0	ea	R30	RES, SMD, 0603, DNP-PLACE HOLDER, ROHS		
H2510-01051-1/16W1-T	1	ea	R4	RES, SMD, 0402, 1.05k, 1/16W, 1%, TF, ROHS	VENKEL	CR0402-16W-1051FT
					PANASONIC	ERJ-2RKF1051X
					VISHAY/DALE	CRCW04021K05FKED
131-4353-00	2	ea	SP1, SP2	CONN-SCOPE PROBE TEST PT, COMPACT, PCB MNT, ROHS	TEKTRONIX	131-4353-00
GT11MSCBE-T	1	ea	SW1	SWITCH-TOGGLE, SMD, ULTRAMINI, 1P, SPST MINI	C&K COMPONENTS	GT11MSCKE
5002	2	ea	TP13, TP16	CONN-MINI TEST POINT, VERTICAL, WHITE, ROHS	KEYSTONE	5002
1514-2	4	ea	TP1-TP4	CONN-TURRET, TERMINAL POST, TH, ROHS	KEYSTONE	1514-2
ISL8500IRZ	1	ea	U1	IC-2A BUCK REGULATOR, 12P, DFN, 4x3, ROHS	INTERSIL	ISL8500IRZ

ISL8500EVAL2Z Board Layout

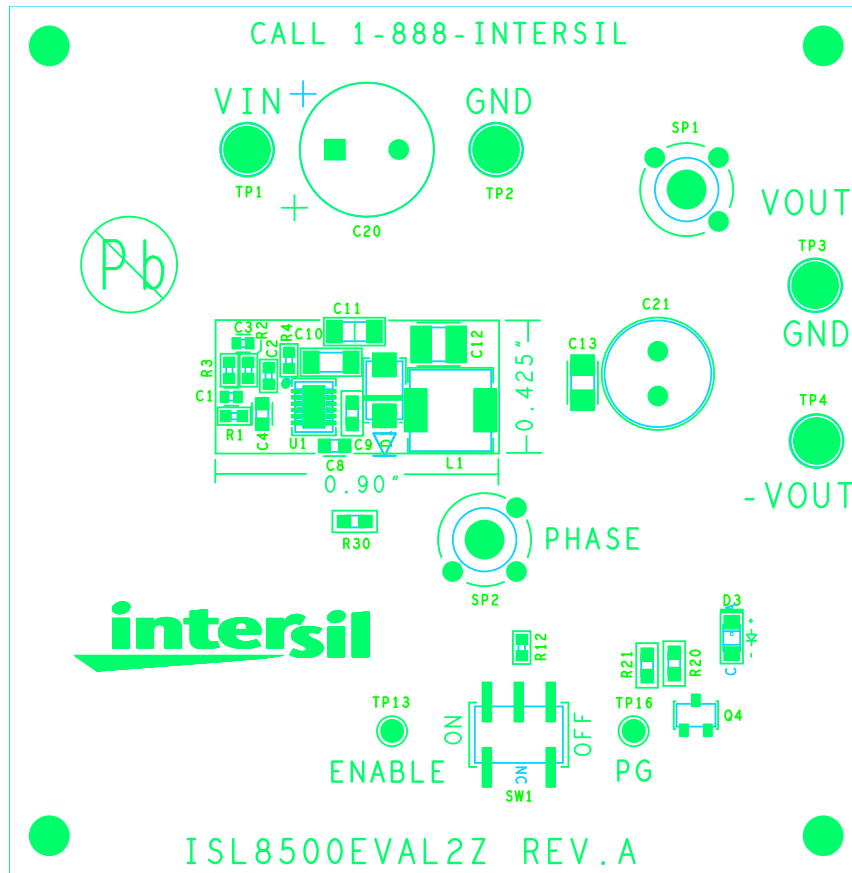

FIGURE 2. TOP COMPONENTS

ISL8500EVAL2Z Board Layout (Continued)

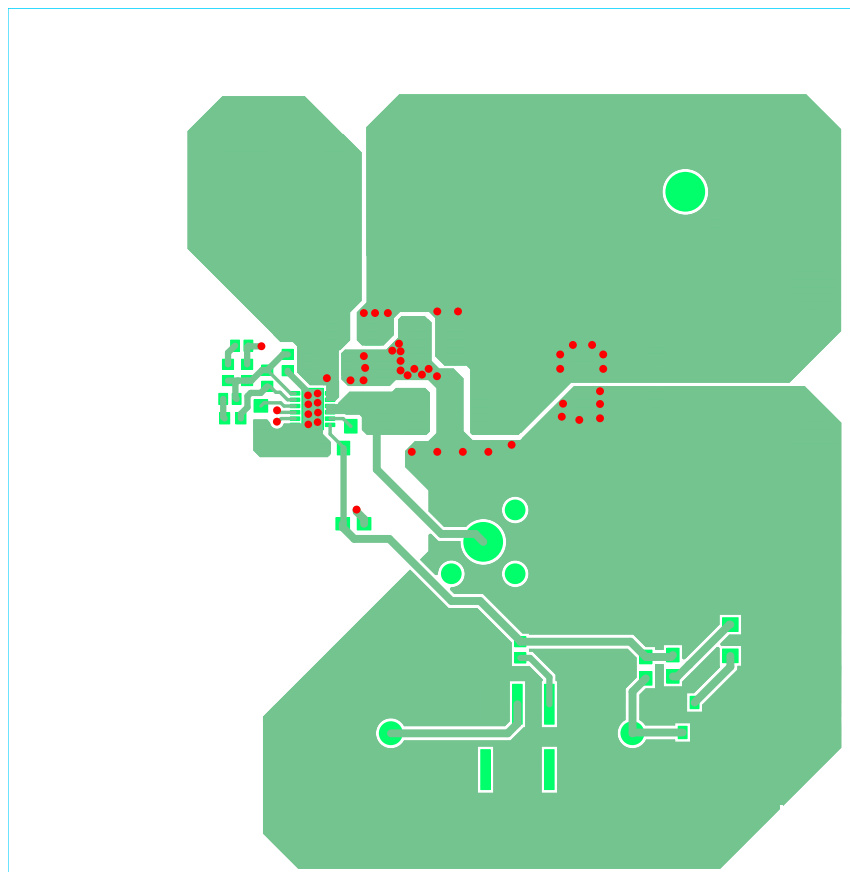

FIGURE 3. TOP LAYER ETCH

ISL8500EVAL2Z Board Layout (Continued)

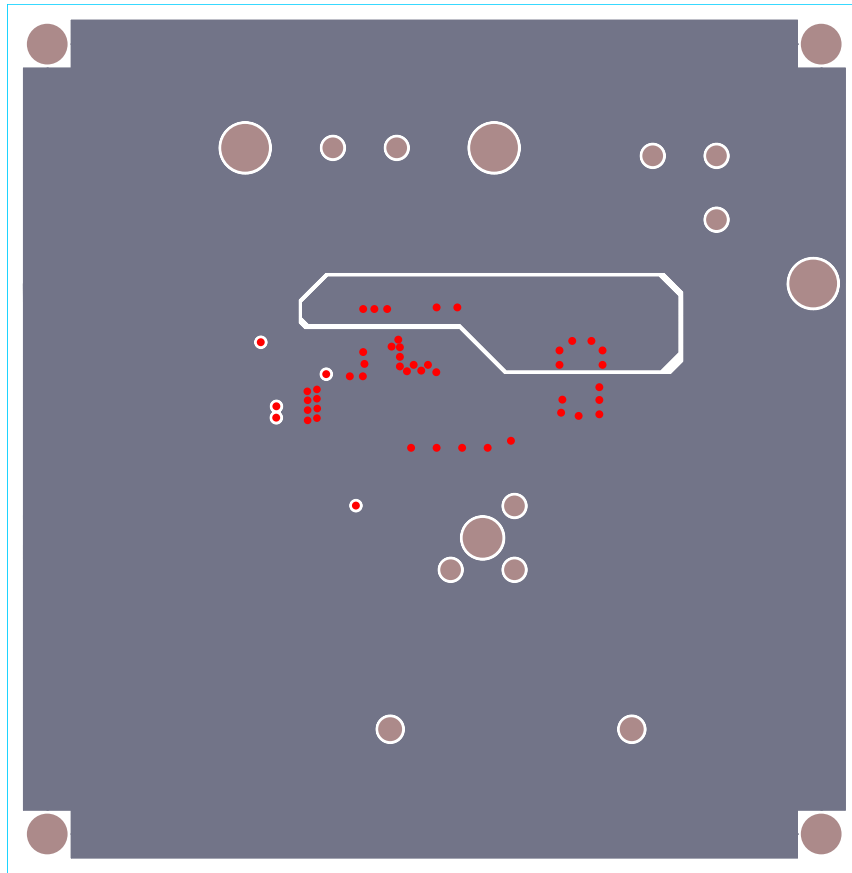

FIGURE 4. 2nd LAYER ETCH

ISL8500EVAL2Z Board Layout (Continued)

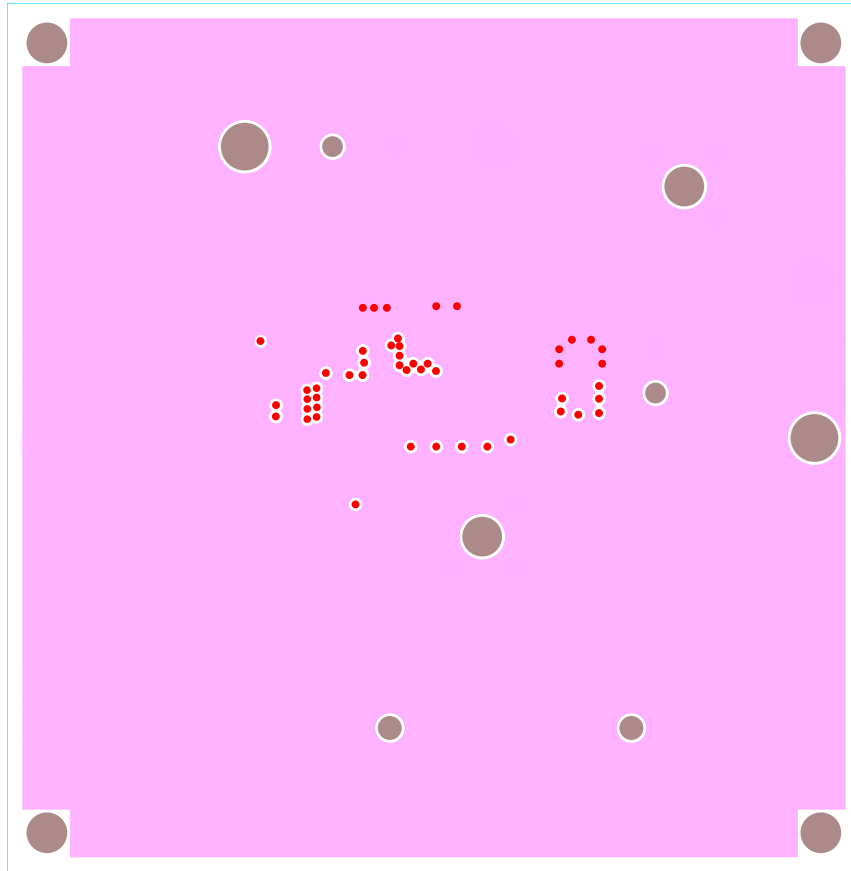

FIGURE 5. 3rd LAYER ETCH

ISL8500EVAL2Z Board Layout (Continued)

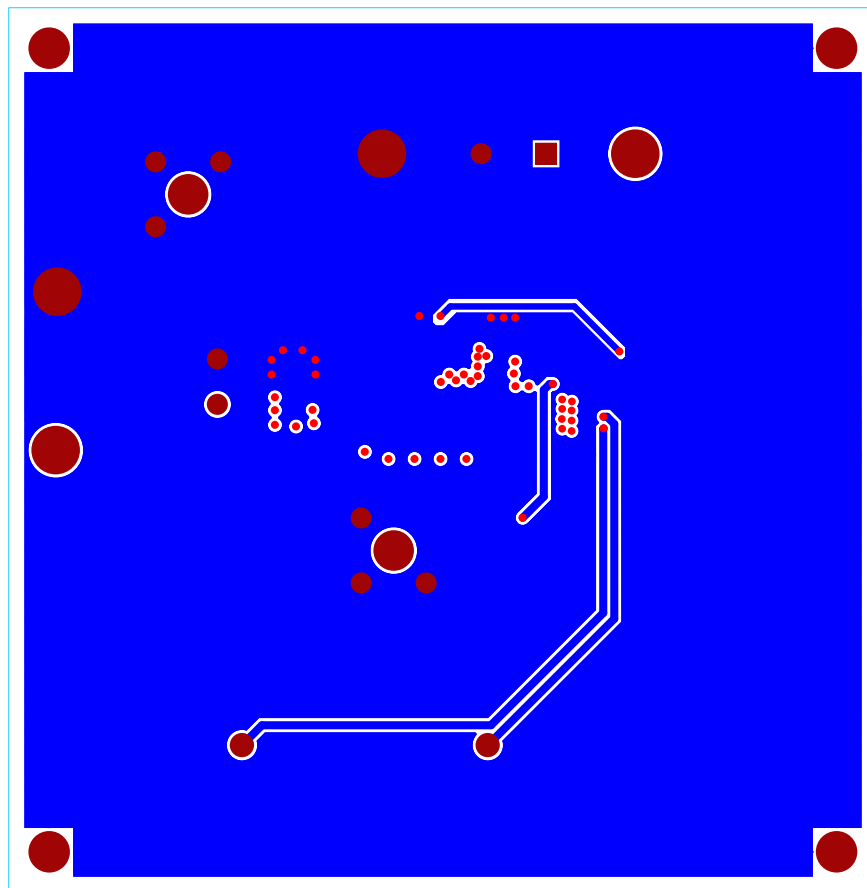

FIGURE 6. BOTTOM LAYER ETCH (Mirrored)

Theory of Operation

The ISL8500 in this configuration is a non-synchronous positive to negative switching regulator which can handle input voltages above, below, or equal to the absolute value of the output. The ISL8500EVAL2Z circuit design is optimized for 12V input to -12V output applications. The regulator operates at 500kHz fixed switching frequency, F_S , under heavy load conditions to allow smaller external inductors and capacitors to be used for minimal printed-circuit board (PCB) area. At light load, the regulator reduces the switching frequency by skipping pulses to maintain regulation and increase efficiency.

The principle of operation is shown in Figure 7 and uses the energy storage of the inductor L during the on period, and then transfers the energy through the free wheeling diode, D, to the output. When the HS MOSFET switch turns on, the diode is reverse biased, and the inductor current will ramp up. When the switch is off, as shown in Figure 8, the inductor will reverse its polarity to maintain its peak current. The forward biased diode and the stored energy of the inductor gets transferred to the load and the output capacitor. Since the voltage of the inductor is negative with respect to GND, the output voltage across the capacitor will be negative. This type of converter can step up and down the magnitude of the input voltage. Therefore, this circuit is called a buck-boost converter. For steady state operation, the volt-second of the inductor must equal, $DV_L = (1-D)V_L$. V_L is equal to V_{IN} during the ON time and V_L is equal to $-V_{OUT}$ during the OFF time. Therefore, the DC steady state transfer is $V_{OUT}/V_{IN} = -D/(1-D)$. Figure 9 is the voltage and current waveforms.

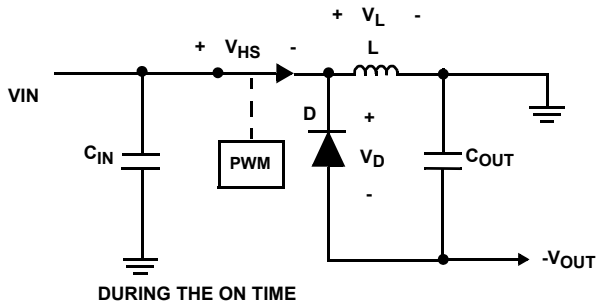

FIGURE 7. VOLTAGE ACROSS THE ELEMENT DURING THE ON TIME

Equation 2 for Figure 7:

$$\begin{aligned} V_L &= V_{IN} \\ V_D &= V_{IN} + V_{OUT} \\ V_{HS} &\approx 0V \end{aligned} \tag{EQ. 2}$$

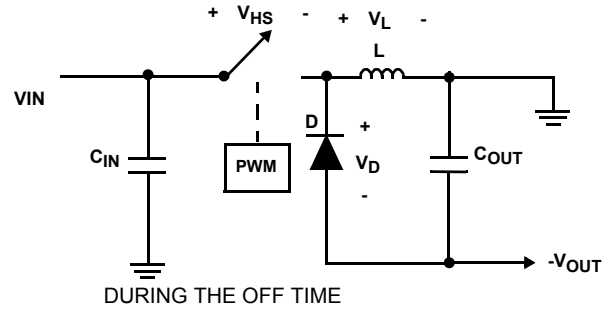

FIGURE 8. VOLTAGE ACROSS THE ELEMENT DURING THE OFF TIME

Equation 3 for Figure 8:

$$\begin{aligned} V_L &= V_{OUT} \\ V_D &\approx 0V \\ V_{HS} &= V_{IN} + V_{OUT} \end{aligned} \tag{EQ. 3}$$

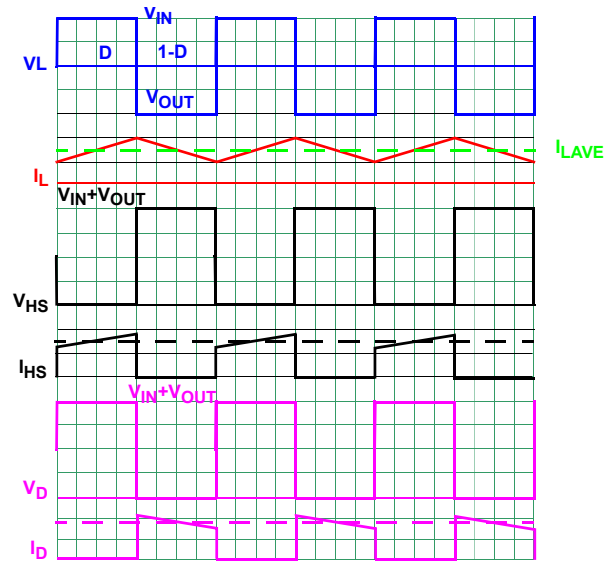

FIGURE 9. SIMPLIFICATION OF THE BUCK BOOST CONVERTER

Equation 4 for Figure 9:

$$\begin{aligned} D &= \frac{V_{OUT}}{V_{IN} + V_{OUT}} \\ I_{LAVE} &= I_{OUT} \left(1 + \frac{D}{1-D} \right) \\ \Delta I_L &= V_{IN} \cdot \frac{D}{L \cdot F_S} \end{aligned} \tag{EQ. 4}$$

Component Selection

This section will detail the calculation and selection of the components. Calculations are done in continuous operation mode.

Inductor Selection

From Equation 3 and ignoring the diode V_D and $r_{DS(ON)}$ of the FET, the duty cycle is shown in Equation 5.

$$D \approx \frac{|V_{OUT}|}{V_{IN} + |V_{OUT}|} \quad (\text{EQ. 5})$$

For this example, D is $12V/(12V+12V) = 0.5$.

The average inductor current is shown in Equation 6.

$$I_{LAVE} = I_{OUT} \left(1 + \frac{D}{1-D}\right) = I_{OUT} \left(\frac{1}{1-D}\right) \quad (\text{EQ. 6})$$

The higher or lower inductor value can be used to optimize the total converter system performance. For example, for higher output voltage application, in order to decrease the inductor current ripple and output voltage ripple, the output inductor value can be increased. It is recommended to set the ripple inductor current approximately 20% to 30% of the maximum average inductor current for optimized performance. The inductor ripple current can be expressed as shown in Equation 7:

$$L = \frac{V_{IN} \cdot V_{OUT}}{(V_{IN} + V_{OUT})(0.3 \cdot I_{LAVE}) \cdot f_S} \quad (\text{EQ. 7})$$

where f_S is the switching frequency. The inductor's saturation current rating needs to be at least larger than the peak current. The ISL8500 protects the typical peak current 3.1A. The saturation current needs be over 4A for maximum output current application. For I_{OUT} of 1A, the inductor L is 24 μ H. Then use 22 μ H.

Diode Selection

The free wheeling diode had to be able to handle the maximum voltage and current stress. The voltage stress is equal to V_{IN} plus V_{OUT} and the current stress is $I_{LAVE} + 0.5\Delta I_L$. The power dissipation is shown in Equation 8.

$$P_D = (I_{LAVE} + 0.5\Delta I_L) \cdot V_D \cdot (1+D) \quad (\text{EQ. 8})$$

where V_D is the forward voltage of the diode. This value is typically 0.5V for 3A Schottky diode. A 30V or 40V 3A, B340LB is a good choice.

Output Capacitor Selection

The output capacitor has to be selected based on its R_{ESR} value, and the capacitance must be high enough to hold the charges for the load during the off time. The output ripple is shown in Equation 9.

$$\Delta V_{OUT} = R_{ESR} \cdot (I_{LAVE} + 0.5\Delta I_L) \quad (\text{EQ. 9})$$

where ΔV_{OUT} is the desired output ripple. The minimum output capacitor value for tis output ripple is shown in Equation 10.

$$C_{OUT} = \frac{I_{OUT} \cdot D}{f_S \cdot \Delta V_{OUT}} \quad (\text{EQ.10})$$

Use 47 μ F 16V ceramic for this example.

Input Capacitor Selection

The main functions for the input capacitor are to provide decoupling of the parasitic inductance and to provide filtering function to prevent the switching current flowing back to the battery rail. Two 10 μ F X5R or X7R ceramic capacitors are a good starting point for the input capacitor selection. One capacitor connecting from V_{IN} to $-V_{OUT}$ and another one connecting from V_{IN} to GND.

Compensation Selection

The buck-boost typology is difficult to stabilize because it has a right-half-plane zero in its control to output transfer function. The small signal AC model of the buck-boost power section in relationship to $d(s)$ is shown in Figure 10.

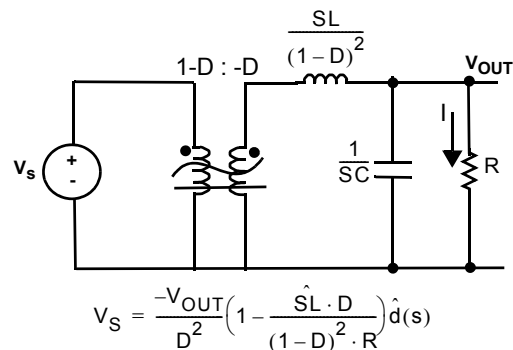

FIGURE 10. SMALL SIGNAL AC MODEL

To solve the power transfer function, see Equation 11.

$$H(S) = \frac{\hat{V}_{OUT}(S)}{\hat{d}(S)} = \frac{V_{IN} - V_{OUT}}{1-D} \left(\frac{1 - \frac{SLI}{(1-D)(V_{IN} - V_{OUT})}}{1 + \frac{SL}{(1-D)^2 R} + \frac{S^2 LC}{(1-D)^2}} \right) \quad (\text{EQ.11})$$

The salent characteristics are shown in Equation 12.

$$H(0) = \frac{V_{IN} - V_{OUT}}{1-D} = \frac{V_{OUT}}{D(1-D)} = \frac{12V}{0.5 \cdot 0.5} = 48$$

$$\rightarrow H(0)=33.8\text{dB}$$

$$\omega_Z = \frac{(1-D)(V_{IN} - V_{OUT})}{LI} = \frac{(1-D)^2 R}{DL}, \text{ this is RHPZ}$$

$$\omega_Z = \frac{0.5^2 \cdot 12\Omega}{22\mu\text{H} \cdot 1\text{A}} = 136 \times 10^3 \rightarrow F_Z = 43.4 \times 10^3 \text{Hz}$$

$$Q = (1-D)R \sqrt{\frac{C}{L}} = 0.5 \cdot 12\Omega \cdot \sqrt{\frac{44\mu\text{F}}{22\mu\text{H}}} = 8.77 \quad (\text{EQ.12})$$

$$\rightarrow Q=18.9\text{dB}$$

$$\omega_{LC} = \frac{(1-D)}{\sqrt{LC}} = \frac{0.5}{\sqrt{22\mu\text{H} \cdot 47\mu\text{F}}} = 12 \times 10^3$$

$$\rightarrow F_{LC}=2.4\text{kHz}$$

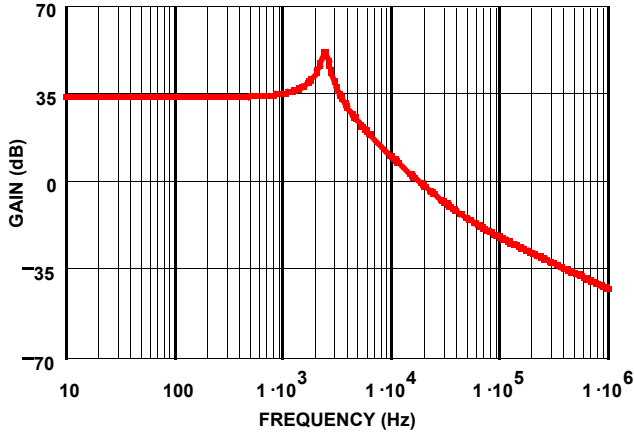

FIGURE 11. GAIN ON H(S) IN dB

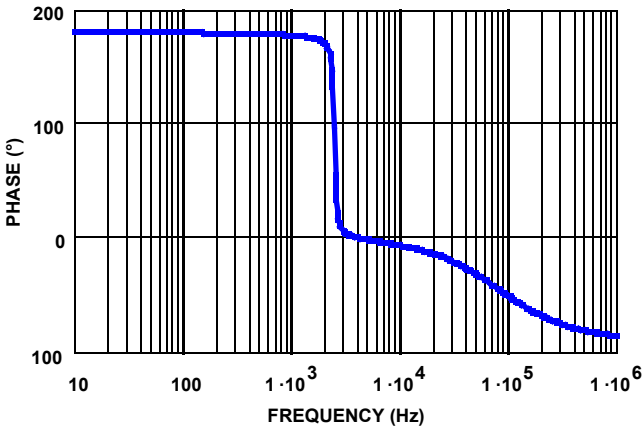

FIGURE 12. PHASE OF H(S) IN °

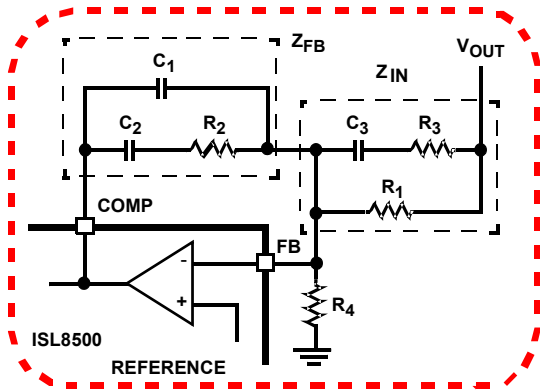

FIGURE 13. DETAILED COMPENSATION NETWORK

The compensation network consists of the error amplifier (internal to the ISL8500) and the impedance networks. The goal of the compensation network is to provide a closed loop transfer function with the highest OdB crossing frequency (f_{0dB}) and adequate phase margin.

From the transfer function, there is a right-half-plane-zero. Therefore, it is highly recommended to insure that the crossover frequency, F_c , is well before the F_z . Figures 11 and 12 are the bode plot of the gain and phase for $H(S)$.

Phase margin is the difference between the closed loop phase at f_{0dB} and 180° . Equation 13 relates the compensation network's poles, zeros and gain to the components (R_1, R_2, R_3, C_1, C_2 , and C_3) in Figure 14. Use the following guidelines for locating the poles and zeros of the compensation network:

1. Pick Gain (R_2/R_1) for converter bandwidth ($\sim 30\% F_z$).
2. Place 1ST Zero Below Filter's Double Pole ($\sim 30\% F_{LC}$).
3. Place 2ND Zero at Filter's Double Pole.
4. Place 1ST Pole at half the Switching Frequency.
5. Place 2ND Pole at the 2.5x of RHP Zero.
6. Check Gain against Error Amplifier's Open-Loop Gain.

Estimate Phase Margin - Repeat if Necessary.

Compensation Break Frequency Equations

$$F_{Z1} = \frac{1}{2\pi \times R_2 \times C_2} \quad F_{P1} = \frac{1}{2\pi \times R_2 \times \left(\frac{C_1 \times C_2}{C_1 + C_2}\right)} \quad (EQ. 13)$$

$$F_{Z2} = \frac{1}{2\pi \times (R_1 + R_3) \times C_3} \quad F_{P2} = \frac{1}{2\pi \times R_3 \times C_3}$$

Figures 14 and 15 shows the bode plot of the gain and phase for the closed loop response.

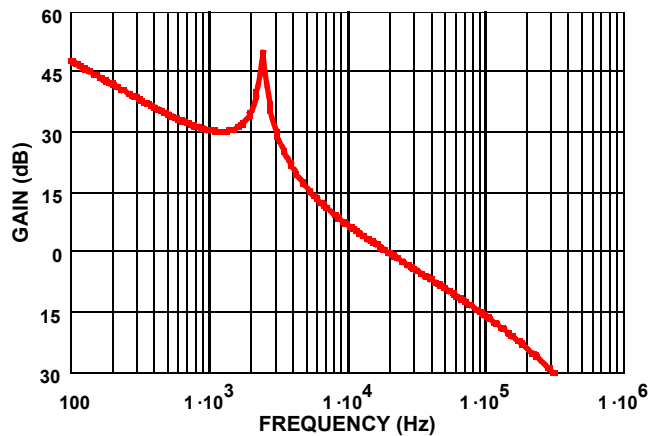

FIGURE 14. GAIN OF CLOSED LOOP IN dB

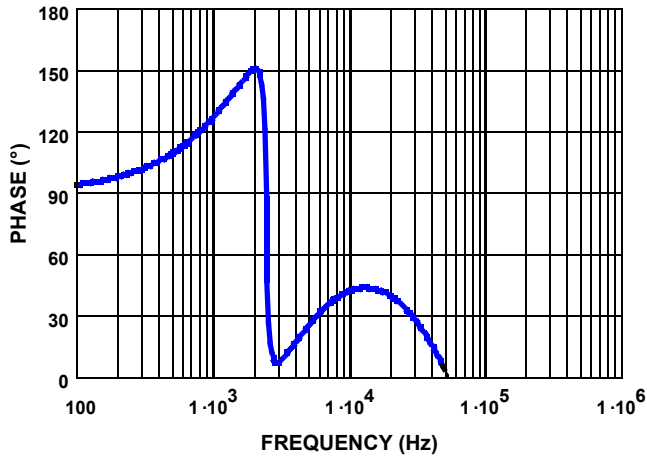

FIGURE 15. PHASE OF CLOSED LOOP IN °

The compensation gain uses external impedance networks Z_{FB} and Z_{IN} to provide a stable, high bandwidth (BW) overall loop. A stable control loop has a gain crossing with -20dB/decade slope, and a phase margin greater than 40° . Include worst case component variations when determining phase margin.

Typical Performance Curves

$T_A = +25^\circ\text{C}$, Unless Otherwise Specified, operating conditions are:
 $T_A = +25^\circ\text{C}$, $V_{IN} = 12\text{V}$, $EN = V_{DD}$, $L = 22\mu\text{H}$, $C12 = 100\mu\text{F}$,
 $C10 = C11 = 10\mu\text{F}$, $I_{OUT} = 0\text{A to } 1\text{A}$.

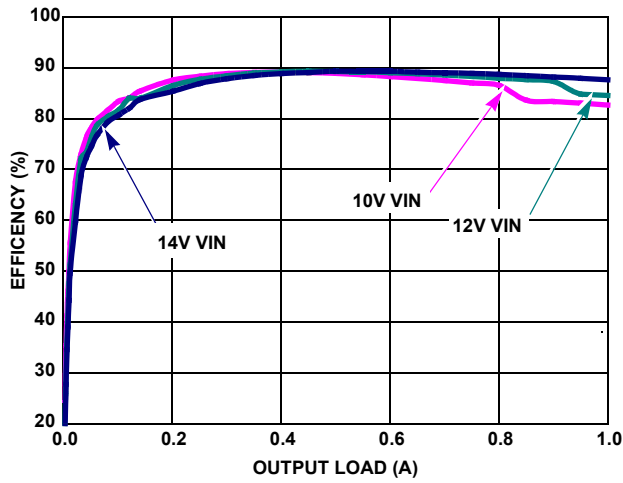

FIGURE 16. EFFICIENCY vs LOAD

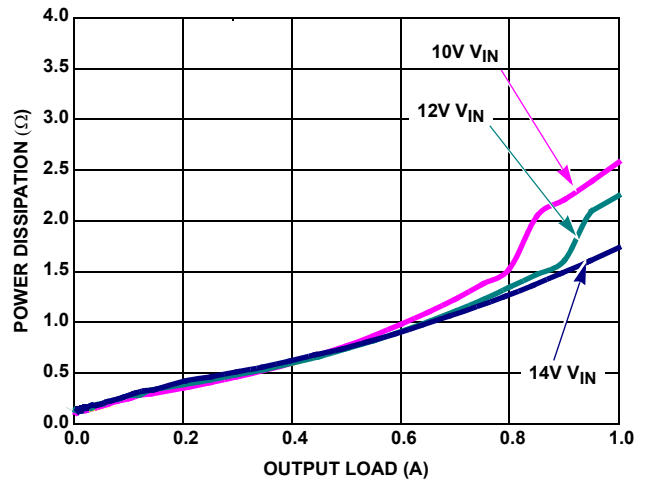

FIGURE 17. POWER DISSIPATION vs LOAD

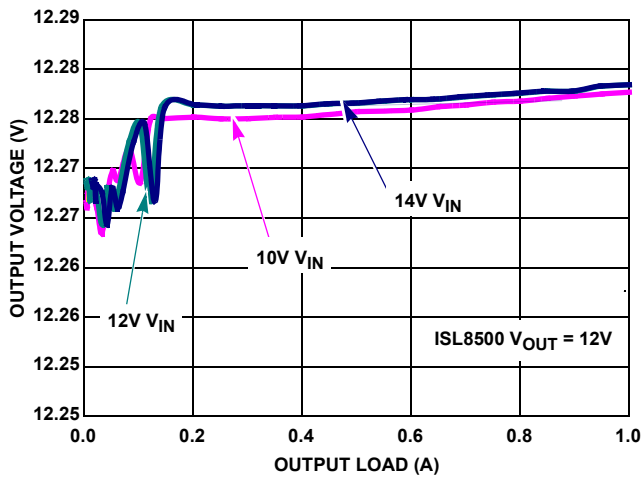

FIGURE 18. V_{OUT} REGULATION vs LOAD

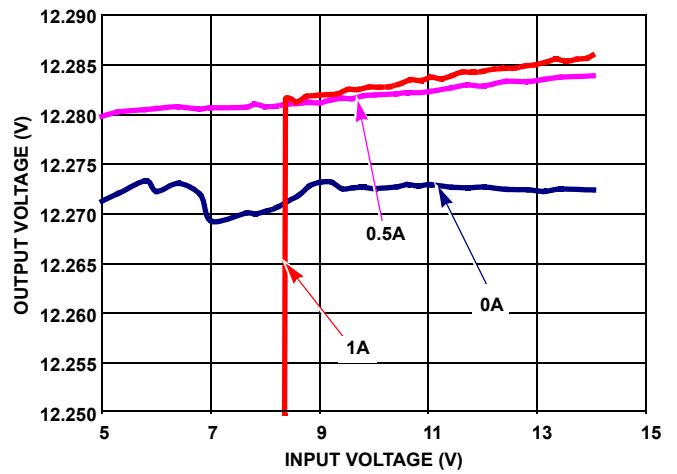

FIGURE 19. OUTPUT VOLTAGE REGULATION vs V_{IN}

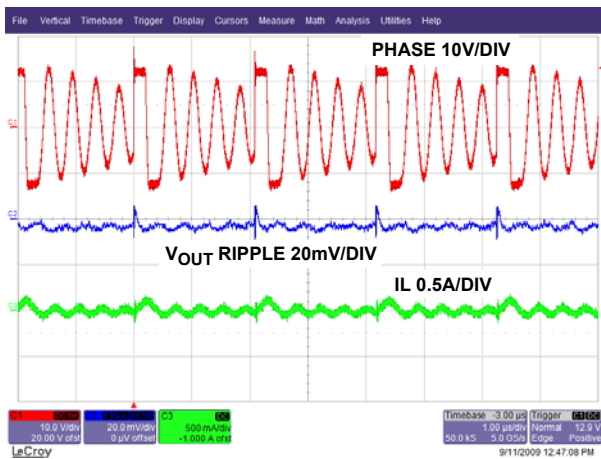

FIGURE 20. STEADY STATE OPERATION AT NO LOAD

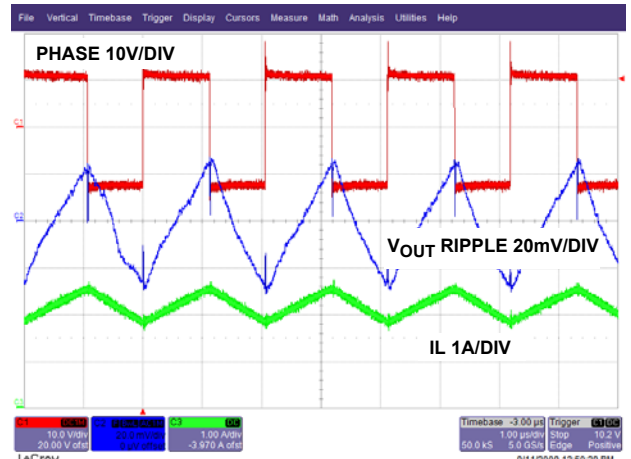

FIGURE 21. STEADY STATE OPERATION AT FULL LOAD

Typical Performance Curves

$T_A = +25^\circ\text{C}$, Unless Otherwise Specified, operating conditions are:
 $T_A = +25^\circ\text{C}$, $V_{IN} = 12\text{V}$, $EN = V_{DD}$, $L = 22\mu\text{H}$, $C12 = 100\mu\text{F}$,
 $C10 = C11 = 10\mu\text{F}$, $I_{OUT} = 0\text{A to } 1\text{A}$. (Continued)

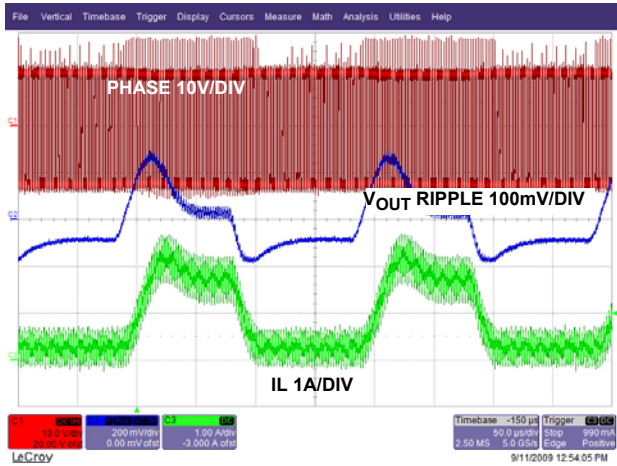

FIGURE 22. LOAD TRANSIENT

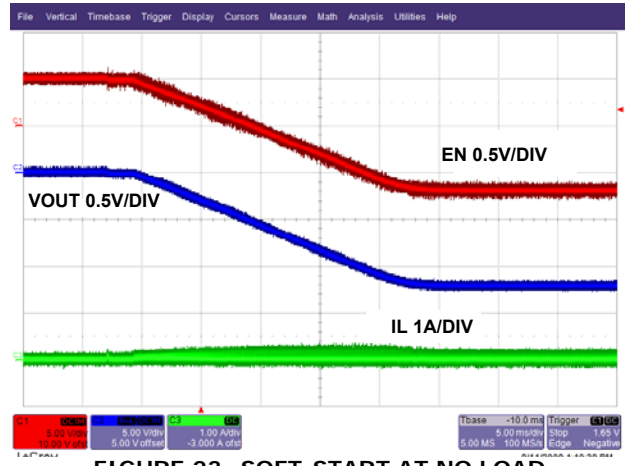

FIGURE 23. SOFT-START AT NO LOAD

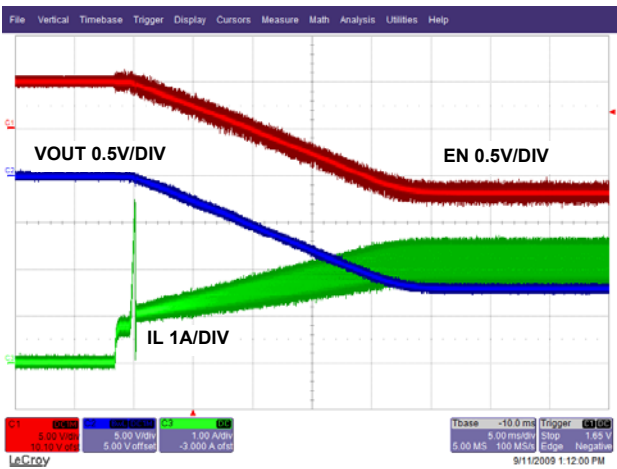

FIGURE 24. SOFT-START AT FULL LOAD

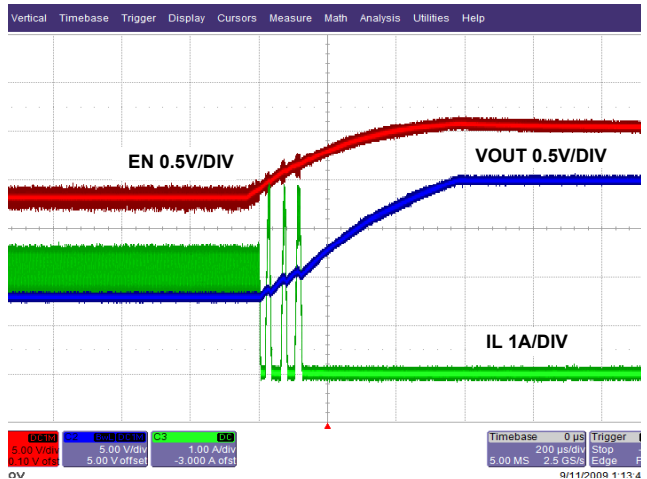

FIGURE 25. SHUT-DOWN CIRCUIT

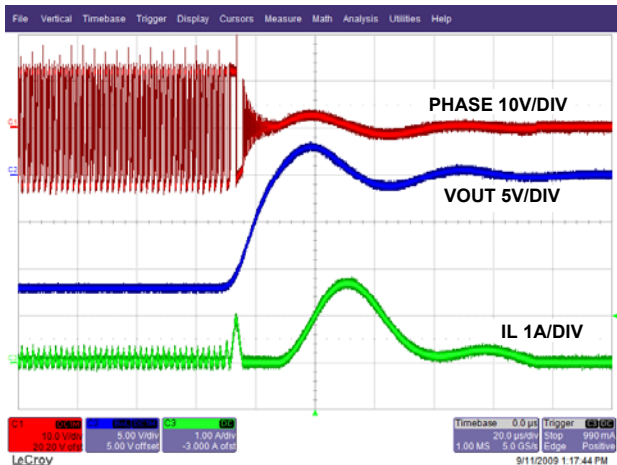

FIGURE 26. OUTPUT SHORT CIRCUIT

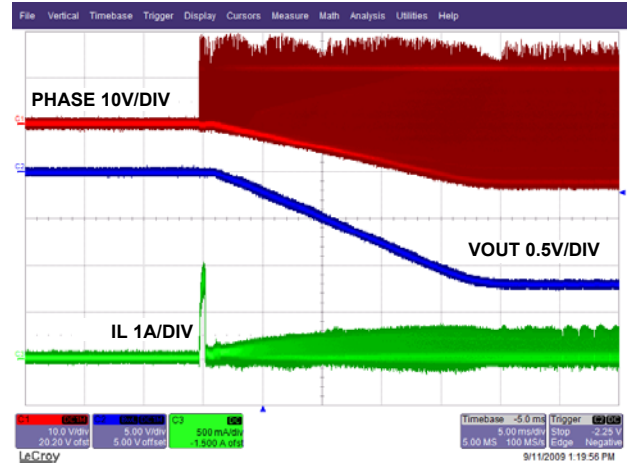

FIGURE 27. OUTPUT SHORT CIRCUIT RECOVERY

Notice

1. Descriptions of circuits, software and other related information in this document are provided only to illustrate the operation of semiconductor products and application examples. You are fully responsible for the incorporation or any other use of the circuits, software, and information in the design of your product or system. Renesas Electronics disclaims any and all liability for any losses and damages incurred by you or third parties arising from the use of these circuits, software, or information.
 2. Renesas Electronics hereby expressly disclaims any warranties against and liability for infringement or any other claims involving patents, copyrights, or other intellectual property rights of third parties, by or arising from the use of Renesas Electronics products or technical information described in this document, including but not limited to, the product data, drawings, charts, programs, algorithms, and application examples.
 3. No license, express, implied or otherwise, is granted hereby under any patents, copyrights or other intellectual property rights of Renesas Electronics or others.
 4. You shall not alter, modify, copy, or reverse engineer any Renesas Electronics product, whether in whole or in part. Renesas Electronics disclaims any and all liability for any losses or damages incurred by you or third parties arising from such alteration, modification, copying or reverse engineering.
 5. Renesas Electronics products are classified according to the following two quality grades: "Standard" and "High Quality". The intended applications for each Renesas Electronics product depends on the product's quality grade, as indicated below.
"Standard": Computers; office equipment; communications equipment; test and measurement equipment; audio and visual equipment; home electronic appliances; machine tools; personal electronic equipment; industrial robots; etc.
"High Quality": Transportation equipment (automobiles, trains, ships, etc.); traffic control (traffic lights); large-scale communication equipment; key financial terminal systems; safety control equipment; etc.
Unless expressly designated as a high reliability product or a product for harsh environments in a Renesas Electronics data sheet or other Renesas Electronics document, Renesas Electronics products are not intended or authorized for use in products or systems that may pose a direct threat to human life or bodily injury (artificial life support devices or systems; surgical implantations; etc.), or may cause serious property damage (space system; undersea repeaters; nuclear power control systems; aircraft control systems; key plant systems; military equipment; etc.). Renesas Electronics disclaims any and all liability for any damages or losses incurred by you or any third parties arising from the use of any Renesas Electronics product that is inconsistent with any Renesas Electronics data sheet, user's manual or other Renesas Electronics document.
 6. When using Renesas Electronics products, refer to the latest product information (data sheets, user's manuals, application notes, "General Notes for Handling and Using Semiconductor Devices" in the reliability handbook, etc.), and ensure that usage conditions are within the ranges specified by Renesas Electronics with respect to maximum ratings, operating power supply voltage range, heat dissipation characteristics, installation, etc. Renesas Electronics disclaims any and all liability for any malfunctions, failure or accident arising out of the use of Renesas Electronics products outside of such specified ranges.
 7. Although Renesas Electronics endeavors to improve the quality and reliability of Renesas Electronics products, semiconductor products have specific characteristics, such as the occurrence of failure at a certain rate and malfunctions under certain use conditions. Unless designated as a high reliability product or a product for harsh environments in a Renesas Electronics data sheet or other Renesas Electronics document, Renesas Electronics products are not subject to radiation resistance design. You are responsible for implementing safety measures to guard against the possibility of bodily injury, injury or damage caused by fire, and/or danger to the public in the event of a failure or malfunction of Renesas Electronics products, such as safety design for hardware and software, including but not limited to redundancy, fire control and malfunction prevention, appropriate treatment for aging degradation or any other appropriate measures. Because the evaluation of microcomputer software alone is very difficult and impractical, you are responsible for evaluating the safety of the final products or systems manufactured by you.
 8. Please contact a Renesas Electronics sales office for details as to environmental matters such as the environmental compatibility of each Renesas Electronics product. You are responsible for carefully and sufficiently investigating applicable laws and regulations that regulate the inclusion or use of controlled substances, including without limitation, the EU RoHS Directive, and using Renesas Electronics products in compliance with all these applicable laws and regulations. Renesas Electronics disclaims any and all liability for damages or losses occurring as a result of your noncompliance with applicable laws and regulations.
 9. Renesas Electronics products and technologies shall not be used for or incorporated into any products or systems whose manufacture, use, or sale is prohibited under any applicable domestic or foreign laws or regulations. You shall comply with any applicable export control laws and regulations promulgated and administered by the governments of any countries asserting jurisdiction over the parties or transactions.
 10. It is the responsibility of the buyer or distributor of Renesas Electronics products, or any other party who distributes, disposes of, or otherwise sells or transfers the product to a third party, to notify such third party in advance of the contents and conditions set forth in this document.
 11. This document shall not be reprinted, reproduced or duplicated in any form, in whole or in part, without prior written consent of Renesas Electronics.
 12. Please contact a Renesas Electronics sales office if you have any questions regarding the information contained in this document or Renesas Electronics products.
- (Note 1) "Renesas Electronics" as used in this document means Renesas Electronics Corporation and also includes its directly or indirectly controlled subsidiaries.
(Note 2) "Renesas Electronics product(s)" means any product developed or manufactured by or for Renesas Electronics.

(Rev.4.0-1 November 2017)



SALES OFFICES

Renesas Electronics Corporation

<http://www.renesas.com>

Refer to "<http://www.renesas.com/>" for the latest and detailed information.

Renesas Electronics America Inc.
1001 Murphy Ranch Road, Milpitas, CA 95035, U.S.A.
Tel: +1-408-432-8888, Fax: +1-408-434-5351

Renesas Electronics Canada Limited
9251 Yonge Street, Suite 8309 Richmond Hill, Ontario Canada L4C 9T3
Tel: +1-905-237-2004

Renesas Electronics Europe Limited
Dukes Meadow, Millboard Road, Bourne End, Buckinghamshire, SL8 5FH, U.K
Tel: +44-1628-651-700, Fax: +44-1628-651-804

Renesas Electronics Europe GmbH
Arcadiastrasse 10, 40472 Düsseldorf, Germany
Tel: +49-211-6503-0, Fax: +49-211-6503-1327

Renesas Electronics (China) Co., Ltd.
Room 1709 Quantum Plaza, No.27 ZhichunLu, Haidian District, Beijing, 100191 P. R. China
Tel: +86-10-8235-1155, Fax: +86-10-8235-7679

Renesas Electronics (Shanghai) Co., Ltd.
Unit 301, Tower A, Central Towers, 555 Langao Road, Putuo District, Shanghai, 200333 P. R. China
Tel: +86-21-2226-0888, Fax: +86-21-2226-0999

Renesas Electronics Hong Kong Limited
Unit 1601-1611, 16/F., Tower 2, Grand Century Place, 193 Prince Edward Road West, Mongkok, Kowloon, Hong Kong
Tel: +852-2265-6688, Fax: +852-2886-9022

Renesas Electronics Taiwan Co., Ltd.
13F, No. 363, Fu Shing North Road, Taipei 10543, Taiwan
Tel: +886-2-8175-9600, Fax: +886-2-8175-9670

Renesas Electronics Singapore Pte. Ltd.
80 Bendemeer Road, Unit #06-02 Hyflux Innovation Centre, Singapore 339949
Tel: +65-6213-0200, Fax: +65-6213-0300

Renesas Electronics Malaysia Sdn.Bhd.
Unit 1207, Block B, Menara Amcorp, Amcorp Trade Centre, No. 18, Jln Persiaran Barat, 46050 Petaling Jaya, Selangor Darul Ehsan, Malaysia
Tel: +60-3-7955-9390, Fax: +60-3-7955-9510

Renesas Electronics India Pvt. Ltd.
No.777C, 100 Feet Road, HAL 2nd Stage, Indiranagar, Bangalore 560 038, India
Tel: +91-80-67208700, Fax: +91-80-67208777

Renesas Electronics Korea Co., Ltd.
17F, KAMCO Yangjae Tower, 262, Gangnam-daero, Gangnam-gu, Seoul, 06265 Korea
Tel: +82-2-558-3737, Fax: +82-2-558-5338